

FESTA®

PROFESIONÁLNE  NÁRADIE

2022





Značka kvalitného ručného náradia pre stavbu dielňu aj záhradu



Značka profesionálnych vodováh



Značka profesionálnych vodováh a kvalitných lát



Profesionálny zavlažovací sortiment s moderným designom, kompatibilný s radom produktov Rosa



Kvalitného zavlažovacie systémy a záhradné náradie



Japonské nože s dlhoročnou tradíciou



Profesionálne meradlá



Profesionálne rezačky obkladov



Výrobca kvalitných záhradných nožníc



Profesionálne stavebné miešačky



Profesionálne skrutkovacie nástavce



Značka profesionálnych plátok



MERADLÁ

2 - 37



4

ZVINOVACIE METRE A PÁSMA KOMELON



6

ZVINOVACIE METRE FESTA



9

PÁSMA



10

SKLADACIE METRE



12

POSUVNÉ MERADLÁ



13

PRAVÍTKA A UHOLNÍKY



15

VODOVÁHY A LATY HORIZONT



20

VODOVÁHY NIVELA



21

DIGITÁLNE VODOVÁHY A UHLOMERY



23

LASERLINER



32

CERUZKY A ZNAČKOVAČE



36

SPREJE

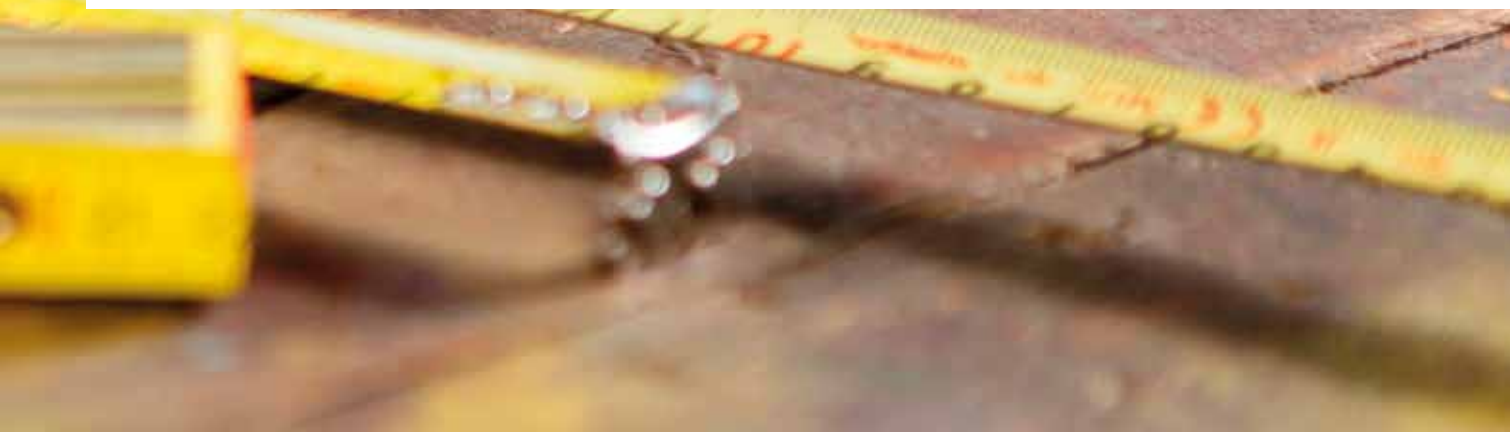



· VYSOKO PRESNÉ A KVALITNÉ MERADLÁ

KOMELON®

- II. trieda presnosti podľa STN 251104, EEC 755345
- Nylonový povrch pásku DURA NY Coat™ zaručuje desaťnásobne vyššiu odolnosť proti oteru stupnice

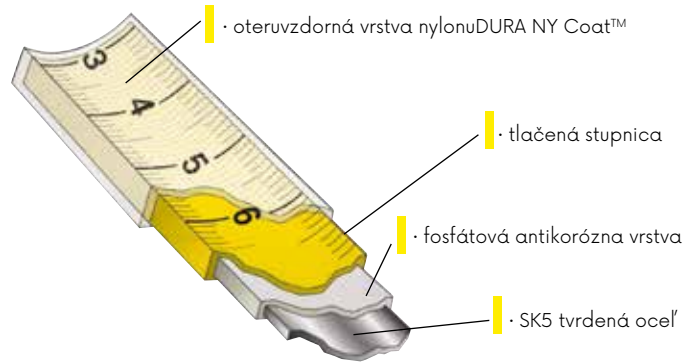

METER ZVINOVACÍ

KOMELON®



· oteruvzdorná vrstva nylonu DURA NY Coat™



Č.p.	špecifikácia	
10002	2 m · 16 mm	10
10003	3 m · 16 mm	10
10005	5 m · 19 mm	10
10008	8 m · 25 mm	10

METER ZVINOVACÍ

KOMELON®



· oteruvzdorná vrstva nylonu DURA NY Coat™



Č.p.	špecifikácia	
10025	5 m · 25 mm	10

METER ZVINOVACÍ

KOMELON®



· oteruvzdorná vrstva nylonu DURA NY Coat™



- automatická brzda
- protišmykové pogumovanie

Č.p.	špecifikácia	
10033	3 m · 16 mm	6
10035	5 m · 19 mm	6

METER ZVINOVACÍ

KOMELON®



Č.p.	špecifikácia	
10043	3 m · 16 mm	30
10045	5 m · 19 mm	30
10048	8 m · 25 mm	12

PÁSMO OCEĽOVÉ

KOMELON®



II. class



Č.p.	špecifikácia	
10110	10 m · 10 mm	6
10120	20 m · 10 mm	6
10130	30 m · 10 mm	6

PÁSMO SKLOLAMINÁTOVÉ

KOMELON®



II. class



Č.p.	špecifikácia	
10330	10 m · 13 mm	6
10332	20 m · 13 mm	6
10334	30 m · 13 mm	6
10336	50 m · 13 mm	6

PÁSMO SKLOLAMINÁTOVÉ

KOMELON®



II. class



Č.p.	špecifikácia	
10430	30 m · 13 mm	1
10450	50 m · 13 mm	1
10490	100 m · 13 mm	1

STOJAN NA METRE

KOMELON®

· osadenie stojanu 10996

- 10003 · 5 ks
- 10005 · 4 ks
- 10008 · 1 ks
- 10033 · 2 ks
- 10035 · 3 ks
- 10045 · 2 ks
- 10025 · 3 ks
- 10110 · 1 ks
- 10120 · 1 ks
- 10130 · 1 ks
- 10430 · 1 ks
- 10330 · 1 ks
- 10332 · 1 ks
- 10334 · 1 ks
- 10336 · 1 ks



· ilustračný foto

STOJAN NA METRE



· ilustračné foto

Č.p.	špecifikácia	
10999	stojan na metre	1
10996	stojan na metre osadený	1

· Informácie o páske metra



- A** 15m · dĺžka metra
- B** II · trieda presnosti
- C** CE · vyhlásenie o zhode - CE
- D** M17 · rok výroby
- E** 0071 · číslo akreditovanej skúšobne vydávajúcej certifikát
- F** 9 · výrobca
- G** 12 · špeciálna úprava pásky
- H** 29°C · teplota, pri ktorej bola skúška vykonávaná

Č.p.	špecifikácia	
10998		1



METER ZVINOVACÍ



- stupnica s veľkými číslami
- protišmykové pogumovanie
- nylonová vrstva



Č.p.	špecifikácia	
11353	3 m · 19 mm	1
11355	5 m · 19 mm	1
11356	5 m · 25 mm	1
11358	8 m · 25 mm	1
11360	10 m · 25 mm	1

METER ZVINOVACÍ



- protišmykové pogumovanie PTE

- pútko



- automatická brzda

- pochromovaný, kovový záves

- ABS puzdro

- nylonová vrstva



Č.p.	špecifikácia	
11343	3 m · 16 mm	6
11345	5 m · 19 mm	6
11347	7,5 m · 25 mm	6

METER ZVINOVACÍ - MAGNET



- 3 x brzda
- magnetický háčik
- príbrzdzenie
- protišmykové pogumovanie



Č.p.	špecifikácia	
11323	3 m · 16 mm	10
11325	5 m · 19 mm	8
11327	7,5 m · 25 mm	6

METER ZVINOVACÍ COMPACT



- malý rozmer metra
- nylonová vrstva



Č.p.	špecifikácia	
11220	3 m · 16 mm	12
11221	5 m · 19 mm	12

METER ZVINOVACÍ



- stupnica s veľkými číslami



Č.p.	špecifikácia	
11226	2 m · 16 mm	10
11239	3 m · 19 mm	10
11259	5 m · 19 mm	10
11260	7,5 m · 25 mm	10

METER ZVINOVACÍ - MAGNETIC



- magnetický háčik
- protišmykové pogumovanie
- fluorescenčná páska
- stupnica s veľkými číslami



Č.p.	špecifikácia	
11102	2 m · 16 mm	10
11103	3 m · 16 mm	10
11105	5 m · 19 mm	10
11106	5 m · 25 mm	10
11107	7,5 m · 25 mm	10
11110	10 m · 25 mm	10

METER ZVINOVACÍ



- matná úprava pásky



Č.p.	špecifikácia	
11002	2 m · 13 mm	12
11003	3 m · 13 mm	12
11005	5 m · 13 mm	12
11006	5 m · 19 mm	12
11007	7,5 m · 19 mm	12
11008	10 m · 25 mm	12

METER ZVINOVACÍ



- metrická a palcová stupnica
- protišmykové pogumovanie



Č.p.	špecifikácia	
11416	5 m · 19 mm	10

METER ZVINOVACÍ



- automatická brzda
- protišmykové pogumovanie



Č.p.	špecifikácia	
11333	3 m · 16 mm	12
11335	5 m · 19 mm	12
11337	7,5 m · 25 mm	12
11338	10 m · 25 mm	12

METER ZVINOVACÍ - ERGO



- príbrzdenie
- protišmykové pogumovanie



Č.p.	špecifikácia	
11082	2 m · 16 mm	12
11083	3 m · 16 mm	12
11085	5 m · 19 mm	12

METER ZVINOVACÍ



- príbrzdenie



Č.p.	špecifikácia	
11200	2 m · 13 mm	24
11201	2 m · 16 mm	24
11202	2 m · 19 mm	24
11204	3 m · 13 mm	24
11205	3 m · 16 mm	24
11206	3 m · 19 mm	24
11207	5 m · 19 mm	12
11208	5 m · 25 mm	12
11209	7,5 m · 25 mm	12
11210	10 m · 25 mm	12

PÁSKA KOVOVÁ, MERACIA, PLOCHÁ, SAMOLEPIACA

II.
class

Č.p.	špecifikácia	
11311	1 m · 12,5 mm	30
11312	2 m · 12,5 mm	30
11313	3 m · 16 mm	30
11314	5 m · 19 mm	30

METER ZVINOVACÍ S MENOM, 3M • 16 MM

CE
II.
class

10

Č.p.	meno na metru	Č.p.	meno na metru	Č.p.	meno na metru
13500	JIŘÍ	13512	MICHAL	13524	ROMAN
13501	PETR	13513	MILAN	13525	ŠIKULA
13502	JOSEF	13514	KAREL	13526	RADEK
13503	TOMÁŠ	13515	VLADIMÍR	13527	MISTR
13504	JAN	13516	DĚDEČEK	13528	ONDŘEJ
13505	MARTIN	13517	MŮJ METR	13529	MAREK
13506	JAROSLAV	13518	VÁCLAV	13530	STANISLAV
13507	FRANTIŠEK	13519	JAKUB	13531	BOREC
13508	PAVEL	13520	LUKÁŠ	13532	TATÍNEK
13509	MIROSLAV	13521	2X MĚŘ	13533	ANTONÍN
13510	BIG BOSS	13522	LADISLAV	13534	ALEŠ
13511	ZDENĚK	13523	DAVID		

METER ZVINOVACÍ - PRÍVESOK

II.
class

FESTA

METER ZVINOVACÍ - PRÍVESOK



- stupnica s veľkými číslami
- charakteristiky plnohodnotného metra

MOQ
12

Č.p.	špecifikácia		Č.p.	špecifikácia	
11410	2 m · 16 mm	6 barev	11420	1 m · 6 mm oranžový	24

METER ZVINOVACÍ - PRÍVESOK



METER ZVINOVACÍ - PRÍVESOK



LIBELA - PRÍVESOK



Č.p.	špecifikácia		Č.p.	špecifikácia		Č.p.	špecifikácia	
11444	1 m · 6 mm bílý	24	11425	1 m · 6 mm	50	11445		100

PÁSMO OCEĽOVÉ

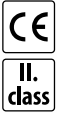

· oko

Č.p.	špecifikácia	
12010	10 m · 10 mm	1
12020	20 m · 10 mm	1
12030	30 m · 10 mm	1
12050	50 m · 10 mm	6

PÁSMO SKLOLAMINÁTOVÉ



· oko

Č.p.	špecifikácia	
12110	10 m · 13 mm	6
12120	20 m · 13 mm	1
12130	30 m · 13 mm	1
12150	50 m · 13 mm	1

PÁSMO OCEĽOVÉ



· oko + háčik

Č.p.	špecifikácia	
12210	10 m · 10 mm	6
12220	20 m · 10 mm	6
12230	30 m · 10 mm	6
12250	50 m · 10 mm	6

PÁSMO OCEĽOVÉ



· oko

Č.p.	špecifikácia	
12433	30 m · 12,5 mm	20
12435	50 m · 12,5 mm	10

MERACIA TELESKOPICKÁ TYČ



· vrátane puzdra

Č.p.	špecifikácia	
15983	0,7 - 3 m	10
15985	1,1 - 5 m	10
15988	1,6 - 8 m	5

MERACIE KOLESO



- odolné, ľahké a kompaktné
- počítadlo pridáva pri pohybe vpred a odčíta pri pohybe vzad
- zabudované osvetlenie pre nočnú prácu, 2 AAA batérie v držadle



Č.p.	špecifikácia	
15989	max. 10 km	2



SKLADACÍ METER



Č.p.	špecifikácia	
13010	1 m · biely	20
13020	2 m · biely	10
13021	1 m · žltý	20
13022	2 m · žltý	10
13023	2 m · bielo – žltý	10
13030	3 m · biely	10

SKLADACÍ METER



Č.p.	špecifikácia	
13111	1 m · žltý	10
13120	2 m · žltý	5

SKLADACÍ METER



Č.p.	špecifikácia	
13210	1 m · mini	10
13211	1 m	1
13220	2 m	1

MERADLO S RUKOVĚŤOU



· 2 x libela

Č.p.	špecifikácia	
14030	600 mm	6

MERADLO OCELOVÉ



Č.p.	špecifikácia	
14010	300 mm	10
14011	600 mm	20
14012	1000 mm	20

MERADLO HLINÍKOVÉ



Č.p.	špecifikácia	
14015	400 mm	48
14017	600 mm	50
14019	1000 mm	40

MERADLO VIACÚČELOVÉ



Č.p.	špecifikácia	
14480	250 x 120 mm	1



SKLADACÍ METER S MENOM



STOJAN NA METRE



10

Č.p.	meno na metru	Č.p.	meno na metru	Č.p.	meno na metru
13401	JIŘÍ	13425	RADEK	13449	VOJTĚCH
13402	JAN	13426	DANIEL	13450	ZDENKO
13403	PETR	13427	ANTONÍN	13451	JANA
13404	JOSEF	13428	VOJTĚCH	13452	EVA
13405	PAVEL	13429	FILIP	13453	PETRA
13406	MARTIN	13430	ADAM	13454	MAJKA
13407	JAROSLAV	13431	MILOSLAV	13455	HANA
13408	TOMÁŠ	13432	MATĚJ	13456	ANNA
13409	MIROSLAV	13433	ALEŠ	13457	LENKA
13410	ZDENĚK	13434	JAROMÍR	13458	KATKA
13411	FRANTIŠEK	13435	LIBOR	13459	LUCIE
13412	VÁCLAV	13436	DOMINIK	13460	ALENA
13413	MICHAL	13437	PATRIK	13461	VERONIKA
13414	MILAN	13438	VLASTIMIL	13462	MARTINA
13415	KAREL	13439	JINDŘICH	13463	JITKA
13416	JAKUB	13440	MILOŠ	13464	BIG BOSS
13417	DAVID	13441	JÁN	13465	2 x MĚŘ
13418	LUKÁŠ	13442	PETER	13466	TATÍNEK
13419	VLADIMÍR	13443	ONDREJ	13467	DĚDEČEK
13420	LADISLAV	13444	JOZEF	13468	ŠIKULA
13421	ONDŘEJ	13445	PAVOL	13469	MISTR
13422	ROMAN	13446	L'UBOMÍR	13470	MACHR
13423	STANISLAV	13447	KAROL	13471	BOREC
13424	MAREK	13448	RADOSLAV	13472	UŽ JE MŮJ
				13473	MŮJ METR

· osadenie stojanu 13399



13401	· 15 ks
13402	· 15 ks
13403	· 15 ks
13404	· 15 ks
13405	· 15 ks
13406	· 15 ks
13412	· 15 ks
13413	· 15 ks
13414	· 15 ks
13415	· 15 ks
13416	· 15 ks
13417	· 15 ks
13418	· 15 ks
13419	· 15 ks
13420	· 15 ks
13421	· 10 ks
13422	· 10 ks
13423	· 10 ks
13424	· 10 ks
13425	· 10 ks
13426	· 10 ks
13427	· 10 ks
13428	· 10 ks
13429	· 10 ks
13430	· 10 ks
13431	· 10 ks
13432	· 10 ks
13433	· 10 ks
13434	· 10 ks
13435	· 10 ks
13436	· 10 ks
13437	· 10 ks
13438	· 10 ks
13439	· 10 ks
13440	· 10 ks

Č.p.	špecifikácia	
13399	stojan na metre osadený	1
13400	stojan na metre	1

MERADLO POSUVNÉ

FESTA

INOX



Č.p.	špecifikácia	
14007	150 0,01 mm	10
14008	200 0,01 mm	10
14009	300 0,01 mm	10



MERADLO POSUVNÉ DIGITÁLNE FIBERGLASS



· presnosť 0,2 mm, rozlíšenie 0,1 mm

Č.p.	špecifikácia	
14013	150 0,2 mm	10



10

MERADLO POSUVNÉ

FESTA

INOX

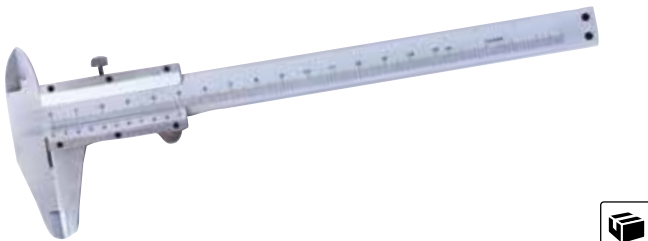

Č.p.	špecifikácia	
14001	150 0,02 mm	10
14002	200 0,02 mm	10
14003	300 0,02 mm	10



MERADLO POSUVNÉ

FESTA

INOX

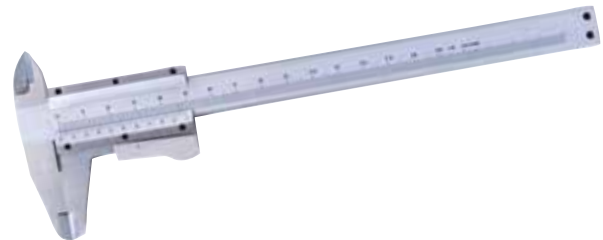

Č.p.	špecifikácia	
14004	150 0,02 mm	10



10

MIKROMETER

FESTA



Č.p.	špecifikácia	
14040	0 - 25 0,01 mm	10
14045	25 - 50 0,01 mm	10



MERADLO POSUVNÉ



HOBBY

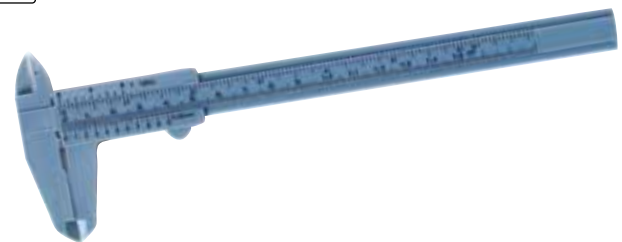

Č.p.	špecifikácia	
14006	150 mm	50



50

ÚCHYLKOMETER

FESTA

INOX



Č.p.	špecifikácia	
14035	0 - 10mm 0,01 mm	10



ŠKÁROVÉ MIERKY



· 20 listů

Č.p.	špecifikácia	
14080	0,05 - 1 mm	10



10

UHLOMER S OTOČNÝM RAMENOM



INOX



· vrátane puzdra

Č.p.	špecifikácia	
14060	0° - 180° · 150 x 200 mm	5
14070	0° - 180° · 300 x 500 mm	7

UHLOMER

HOBBY



Č.p.	špecifikácia	
14075	0° - 180° · 230 x 500 mm	30

UHOLNÍK STOLÁRSKY MULTIFUNKČNÝ

ALU



Č.p.	špecifikácia	
14420	180 mm	10
14421	NEW 300 mm	10

UHOLNÍK TRUHLÁRSKY



UHOLNÍK TESÁRSKY



Č.p.	špecifikácia		Č.p.	špecifikácia		Č.p.	špecifikácia	
14220	200 x 125 mm	10	14235	350 x 190 mm	10	14350	500 x 235 mm	10
14225	250 x 135 mm	10	14240	400 x 190 mm	10	14360	600 x 300 mm	10
14230	300 x 135 mm	10	14250	500 x 210 mm	10	14370	700 x 300 mm	10
						14380	800 x 320 mm	10
						14399	1000 x 360 mm	10

UHOLNÍK

ALU



Č.p.	špecifikácia	
14450	190 x 355 mm	6
14451	200 x 405 mm	6



UHOLNÍK



Č.p.	špecifikácia	
14410	300 x 200 mm	50
14411	600 x 400 mm	36

UHOLNÍK MURÁRSKY



Č.p.	špecifikácia		Č.p.	špecifikácia	
14455	300 x 200 mm	50	14457	700 x 300 mm	40
14456	500 x 250 mm	50	14458	1000 x 450 mm	30

UHOLNÍK PLOCHÝ

Zn

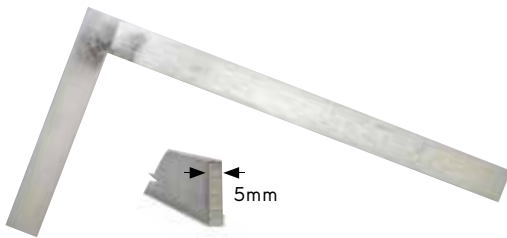

Č.p.	špecifikácia	
14471	150 x 100 mm	25
14472	250 x 125 mm	25
14473	400 x 200 mm	30
14474	600 x 300 mm	25

UHOLNÍK PRÍLOŽNÝ

Zn

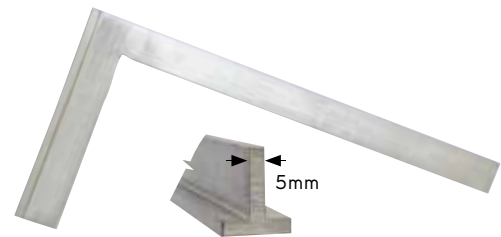

Č.p.	špecifikácia	
14490	100 x 50 mm	10
14491	150 x 75 mm	10
14492	250 x 125 mm	10
14493	400 x 200 mm	10
14494	600 x 300 mm	10

UHOLNÍK STOLÁRSKY

ALU

HOBBY



Č.p.	špecifikácia	
14425	250 x 130 mm	12
14430	300 x 130 mm	12
14435	350 x 156 mm	12
14440	400 x 156 mm	12

POKOSNÍK DREVENÝ

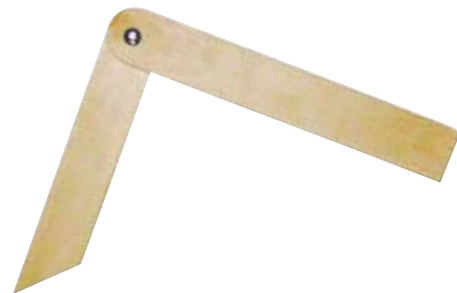
MADE IN
EU

Č.p.	špecifikácia	
14025	255 x 285 mm	1

ŠABLÓNA NA KOPÍROVANIE TVAROV



· zámok



Č.p.	špecifikácia	
14090	125 x 30 mm	1
14091	250 x 30 mm	1

HORIZONT[®] EXACTA

Vodováhy s najvyššou presnosťou

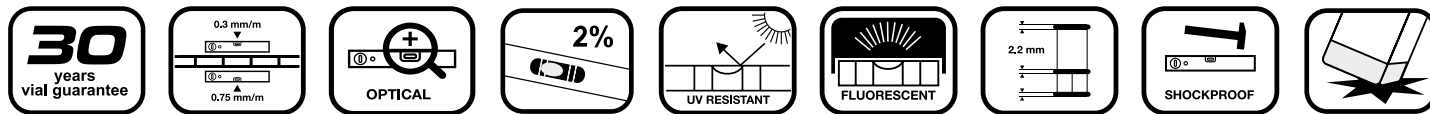

Každý kus je elektronicky testovaný a má svoje registračné číslo, výrobca je držiteľom osvedčenia ISO 9001



VODOVÁHA EXACTA, 2 LIBELY

HORIZONT[®]

ALU



Č.p.	špecifikácia
15033	60 cm



10

VODOVÁHA EXACTA, 3 LIBELY

HORIZONT[®]

ALU



Č.p.	špecifikácia
15034	80 cm
15035	100 cm



10
10

VODOVÁHA EXACTA, 3 LIBELY, S MADLAMI

HORIZONT[®]

ALU



Č.p.	špecifikácia
15036	120 cm
15037	150 cm
15039	200 cm



10
10
10

HORIZONT®

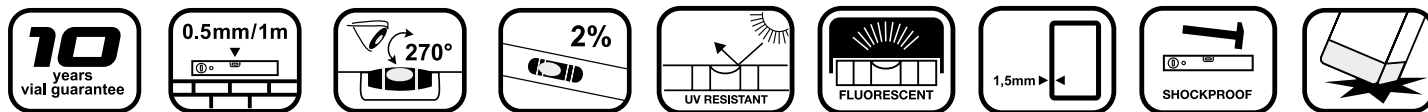

Každý kus je elektronicky testovaný a má svoje registračné číslo, výrobca je držiteľom osvedčenia ISO 9001



VODOVÁHA, 2 LIBELY

HORIZONT®
ALU

Č.p.	špecifikácia	
15003	30 cm	30
15004	40 cm	30
15005	50 cm	30
15006	60 cm	30
15008	80 cm	30
15010	100 cm	30
15012	120 cm	10
15015	150 cm	10
15018	180 cm	10
15020	200 cm	10

VODOVÁHA, 3 LIBELY

HORIZONT®
ALU

Č.p.	špecifikácia	
15103	30 cm	30
15104	40 cm	30
15105	50 cm	30
15106	60 cm	30
15108	80 cm	30
15110	100 cm	30
15112	120 cm	10
15115	150 cm	10
15118	180 cm	10
15120	200 cm	10

VODOVÁHA, 2 LIBELY + MAGNET

HORIZONT



Č.p.	špecifikácia	
15204	40 cm	30
15205	50 cm	30
15206	60 cm	30
15208	80 cm	30
15210	100 cm	30
15212	120 cm	10
15215	150 cm	10
15218	180 cm	10
15220	200 cm	10

VODOVÁHA S MOŽNOSŤOU MERANIA SKLONU, 4 LIBELY

HORIZONT

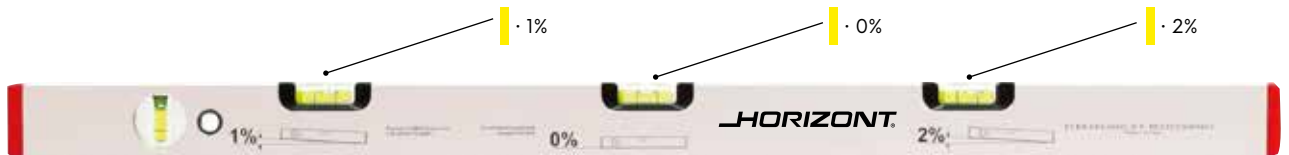

Č.p.	špecifikácia	
15230	80 cm	10

VODOVÁHA S MOŽNOSŤOU MERANIA SKLONU, 1 LIBELA

HORIZONT



Č.p.	špecifikácia	
15235	60 cm	1

LATA SŤAHOVACIA - BEZ LIBIEL

HORIZONT



Č.p.	špecifikácia	
15310	100 cm	10
15315	150 cm	10
15318	180 cm	10
15320	200 cm	10
15325	250 cm	10
15330	300 cm	10
15335	350 cm	10
15340	400 cm	10

LATA SŤAHOVACIA - 1 LIBELA

HORIZONT

ALU



Č.p.	špecifikácia	
15415	150 cm	10
15418	180 cm	10
15420	200 cm	10
15425	250 cm	10
15430	300 cm	10

LATA SŤAHOVACIA - 2 LIBELY

HORIZONT

ALU



Č.p.	špecifikácia	
15510	100 cm	10
15515	150 cm	10
15518	180 cm	10
15520	200 cm	10
15525	250 cm	10
15530	300 cm	10
15535	350 cm	10
15540	400 cm	5

LATA SŤAHOVACIA - S MADLAMI, BEZ LIBIEL

HORIZONT

ALU



Č.p.	špecifikácia	
15615	150 cm	10
15620	200 cm	10
15625	250 cm	10
15630	300 cm	10

LATA SŤAHOVACIA - S MADLAMI, 2 LIBELY

HORIZONT

ALU



Č.p.	špecifikácia	
15710	100 cm	10
15715	150 cm	10
15720	200 cm	10
15725	250 cm	10
15730	300 cm	10
15735	350 cm	10
15740	400 cm	5



PROFIL TRAPÉZOVÝ

- trapézový profil slúži na jemnejšie úpravy povrchu
- vhodné pre štukatérov a fasádnikov
- vhodné pre tenkovrstvé omietky



PROFIL "h"

- "h" profil slúži na jemnejšie úpravy povrchu
- vhodné pre štukatérov a fasádnikov
- vhodné na štukovanie stropných omietok

HORIZONTAL



LATA SŤAHOVACIA - TRAPÉZOVÝ PROFIL HORIZONTAL

ALU



Č.p.	špecifikácia	
15810	100 cm	10
15812	120 cm	10
15815	150 cm	10
15818	180 cm	10
15820	200 cm	10
15825	250 cm	10
15830	300 cm	10

LATA SŤAHOVACIA - H PROFIL HORIZONTAL

ALU



Č.p.	špecifikácia	
15850	100 cm	10
15853	150 cm	10
15855	180 cm	10
15860	200 cm	10
15870	250 cm	10
15880	300 cm	10

STOJAN NA VODOVÁHY HORIZONTAL HORIZONTAL



· osadenie stojana 15998

- 15003 · 5 ks
- 15004 · 5 ks
- 15005 · 5 ks
- 15006 · 5 ks
- 15008 · 5 ks
- 15010 · 5 ks
- 15012 · 5 ks
- 15015 · 3 ks
- 15018 · 3 ks
- 15020 · 3 ks
- 15108 · 3 ks
- 15206 · 3 ks
- 15210 · 3 ks

Č.p.	špecifikácia	
15999	85 x 210 x 50 cm	1
15998	85 x 210 x 50 cm osadený	1

STOJAN NA VODOVÁHY A LATY HORIZONTAL HORIZONTAL



· osadenie stojana 15996

- 15004 · 5 ks
- 15005 · 5 ks
- 15006 · 5 ks
- 15008 · 5 ks
- 15010 · 5 ks
- 15012 · 5 ks
- 15015 · 5 ks
- 15018 · 5 ks
- 15020 · 5 ks
- 15315 · 2 ks
- 15320 · 2 ks
- 15325 · 3 ks
- 15515 · 2 ks
- 15520 · 2 ks
- 15525 · 3 ks

Č.p.	špecifikácia	
15997	55 x 75 x 40 cm	1
15996	55 x 75 x 40 cm osadený	1

- Presnosť 0,5 mm / 1 m (v základnej polohe)
- UV stabilná tekutina libely
- Nárazuvzdorné gumové koncovky
- Hrúbka profilu základne 2,4 mm



VODOVÁHA NIVELA - 2 LIBELY

ALU

RUBBER
ENDSUV
STABLE

■ gumové koncovky



Č.p.	špecifikácia	
15904	40 cm	30
15906	60 cm	30
15908	80 cm	30
15910	100 cm	30
15912	120 cm	20
15915	150 cm	10
15920	200 cm	20

VODOVÁHA - 3 LIBELY

ALU

HOBBY



Č.p.	špecifikácia	
15954	40 cm	60
15956	60 cm	60
15958	80 cm	60
15960	100 cm	30
15962	120 cm	30
15965	150 cm	30
15970	200 cm	30

SKLONOMER DIGITÁLNY



- 0° - 360°
- presnosť ±0,1°
- rozlíšenie 0,1°
- funkcia automatického vypnutia
- funkcia HOLD na uchovávanie nameraných hodnôt
- podsvietený display
- rozmer 60x60x25 mm
- batéria 1xAAA

· magnetická spodná strana



Č.p. špecifikácia

26218



1

VODOVÁHA DIGITÁLNA



- presnosť 0,5 mm | m
- rozlíšenie 0,1°
- funkcia HOLD na uchovávanie nameraných hodnôt
- hrúbka profilu 1,8 mm

Č.p. špecifikácia

26215 600 mm



1

DIGITÁLNY UHLOMER



- LCD display
- rozsah merania
- rozlíšenie
- presnosť

0° - 360°
0,1°
± 0,3



VODOVÁHA S DIGITÁLNYM UHLOMEROM



- LCD display
- rozsah merania
- rozlíšenie
- presnosť

0° - 225°
0,1°
± 0,3



Č.p. špecifikácia

26217 200 mm



1

Č.p. špecifikácia

26216 300 mm



1

LASER KRÍŽOVÝ SA-08



- 650 nm
- 2x AA baterie
- dosah 10 m

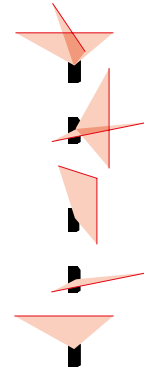

Č.p. špecifikácia

26205



1

VODOVÁHA NA POVRÁZOK

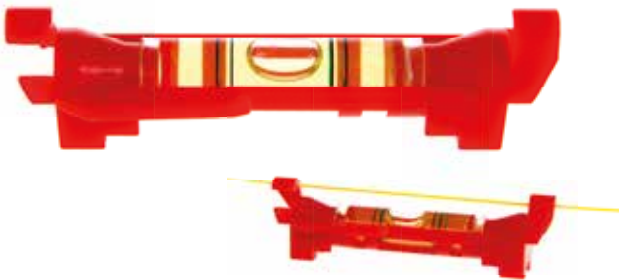

Č.p. špecifikácia

15981



1

VODOVÁHA S MAGNETOM, 3 LIBELY



Č.p. špecifikácia

15980 230 mm



1

VODOVÁHA STĹPOVÁ



- 3 libely, magnety, fixačná páska



Č.p. špecifikácia

26028



12

VODOVÁHA HADICOVÁ



Č.p. špecifikácia

15992 Sklenené rúrky - hadica 10 m

15993 Sklenené rúrky - hadica 15 m

15990 Sklenené rúrky

15991 Plastové rúrky



1

1

50

50

CLIMAPILOT

Laserliner®

Digitálny vlhkomer pre meranie relatívnej vlhkosti a teploty prostredia s indikátorom rosného bodu

- Praktický prístroj na sledovanie klímy v miestnosti
- Digitálny displej s min. | max. hodnotou
- Prepínanie medzi okolitou teplotou | rosným bodom



1x LR44
1,55V



Č.p.	špecifikácia	špecifikácia	špecifikácia	
26460	Rozsah merania okolitej teploty:	0°C ... 50°C	Teplota rosného bodu:	-28,6°C ... 47,9°C
	presnosť:	±1°C	presnosť:	±2°C
	Relatívna vlhkosť vzduchu:	20% rH ... 90% rH	Dodávané s:	batérie
	presnosť:	±5%rH (25%rH... 85% rH)		

MOISTUREFINDER COMPACT

Laserliner®



Profesionálne meranie vlhkosti materiálov - rýchle a nedeštruktívne

- Nedeštruktívne meranie vlhkosti materiálu kapacitným meraním.
- Jednoduchá manipulácia: vyberte druh materiálu, potom prístroj priložte na povrch materiálu na stanovenie obsahu vlhkosti v %
- 4 voliteľné charakteristiky materiálu: mäkké drevo (napr. smrek, borovica, lipa), tvrdé drevo (napr. buk, dub, breza), omietka a cementový poter
- LED indikácia vlhké | suché poskytne okamžité výsledky merania na stanovenie obsahu vlhkosti v testovanom materiáli.

9V



Č.p.	špecifikácia:	špecifikácia:
26527	Cementový poter:	0% ... 5%
	omietka:	0% ... 23%
	Mäkké drevo:	0% ... 52%
	Tvrde drevo:	0% ... 32%

DAMPFINDER COMPACT

Laserliner®



Univerzálny prístroj na meranie vlhkosti dreva a stavebných materiálov

- Pre zistenie vlhkosti v stavebných materiáloch, pre rychlu kontrolu pri práci s drevom
- Trojitá stupnica pre skupiny dreva A, B a režim univerzálneho prehľadu
- Numerické zobrazenie nameranej hodnoty a okolitej teploty
- Osvetlený prehľadný displej



4x AAA



Č.p.	špecifikácia	špecifikácia
26464	drevo:	0% ... 30% ± 1%, 30% ... 60% ± 2%
	Ďalšie materiály:	± 0,5 %
	Dodávané s:	ochranný kryt s funkciou skúšačky, batérie

LUXTEST-MASTER

Laserliner®

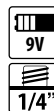

Profesionálny merací prístroj intenzity osvetlenia

- Meranie intenzity osvetlenia na pracoviskách, kanceláriách, vo verejných budovách a v priemysle
- Citlivé fotodiódy s Kosínovou korekciou pre širokouhlé meranie svetla
- Relatívna funkcia merania pre referenčné meranie a porovnávanie
- Špičková funkcia pre registráciu rýchle zmeny v úrovni osvetlenia
- Funkcia automatického zapamätania hodnoty
- Automatické a manuálne prepínanie rozsahu
- Funkcia nulovania
- Meranie premenné: Lux (lm | m2), nožné sviečky (lm | ft2)
- Min. | max. displej
- 1 | 4 „závit pre umiestnenie na statív

Č.p. špecifikácia

Rozsah merania: 20 Lux ... 200000 Lux

26520 presnosť: ± 3% (referenčná hodnota 2854 K)

Kosínus uhlová odchýlka: ± 2% (30°), ± 6% (60°)



1

špecifikácia

Dodávané s: batérie, prepravný kufor

AIRFLOWTEST-MASTER

Laserliner®



Profesionálny anemometer na meranie prietoku vzduchu, objemového prietoku a rýchlosti vetra

- Integrovaný senzor na meranie okolitej teploty, relatívnej vlhkosti a rosného bodu
- USB rozhranie pre ukladanie nameraných dát
- PC softvér
- Veľké obežné koleso: 65 mm.
- Min. | Max. displej.
- 1 | 4 „závit pre pripojenie na statív pri dlhodobom meraní
- Osvetlený, prehľadný displej s trvale viditeľnými hodnotami okolitej teploty a relatívnej vlhkosti

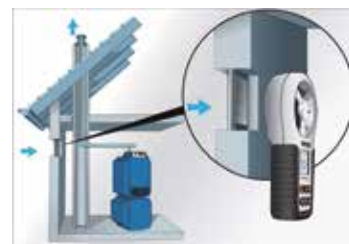

Č.p. špecifikácia

prietok: 0.80...30 m | s | ± 2%

Teplota okolitého prostredia: -10...60°C | ± 1.5°C

26521 Relatívna vlhkosť vzduchu: 20%...80% | ± 3%

Prúd vzduchu: 0...99990 CMM



NAHRÁVANIE DÁT NA PC

špecifikácia

Dodávané s: PC softvér, USB kábel, batérie, prepravný kufor



1

ACTIVEPEN

Laserliner®

SAFETY
CHECK

2x AAA

Bezpečná bezkontaktné kontrola napätia

- Vyhľadá elektrické napätie v kábloch, zásuvkách, objímkach žiaroviek a poistkách
- Určuje polaritu L | N vodičov napr. na zásuvkách alebo v termináloch
- Nájde prerušenie vodičov a káblov
- Výrazná LED kontrolka pre signalizáciu

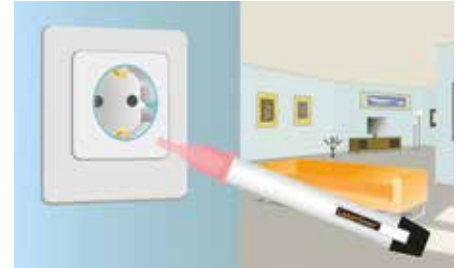

špecifikácia

Dodávané s: batérie

Č.p. špecifikácia

26479 Rozsah merania napätia: 200 V | A ... 600 V | AC, frekvencie: 50 ... 60Hz



1

AC-TRACER

Laserliner®

9V



Bezkontaktný merač trasy elektrického signálu prijímačky

- Bezkontaktné trasovanie vysielaného signálu prijímačom
- Rýchle trasovanie prepojených elektrických obvodov
- Lokácia línií v prepojených živých elektrických predmetov
- Detekcia istených obvodov v živej inštalácii
- Prijímač s akustickým signálom pre lokáciu meraných predmetov
- Prijímač s nastaviteľnou citlivosťou pre jemné nastavenie
- Adaptér do el. zásuvky pre priamu a rýchlu kontrolu inštalácie
- Žiarovkový adaptér E27 pre priamu a rýchlu kontrolu svetelných okruhov



1

Č.p. špecifikácia

26343 Dodávané s: prijímač RECV, konektor EURO, konektor UK (Veľká Británia), E27 Adaptér lampy, batérie, kufřík

THERMOSPOT LASER

Laserliner®

 2x AAA

Bezdotykové infračervené meranie teploty s integrovaným laserovým kruhom pre zacielenie na meraný povrch

- Bezkontaktné meranie je ideálne pre meranie teploty v miestach s ťažkým prístupom, aj pre aplikácie, ako sú napr. pohyblivé časti stroja či elektrickej inštalácie
- 8-bodový laserový kruh meriaci presne potrebnú oblasť
- rozsah merania: -38°C - 360°C
- emisný koeficient: 0,95
- šošovka: 12:1

 Laser
650nm

 max: 30 m

Č.p. špecifikácia

26260 Dodávané s: batérie

1

CONDENSESPOT PLUS

Laserliner®

 2x AA

Infračervený teplomer tepelných mostov a kondenzácie

- 8-bodový laserový kruh merací presne potrebnú oblasť
- Lokalizácia kondenzácie v režime tepelného mosta a rosného bodu
- Rozsah merania -40°C ... 365°C
- Emisný pomer 0,01-1,0
- Funkcia farebného upozornenia pomocou farieb na displeji
- Rýchly výber 5 predvolených hodnôt emisií
- Stĺpcový graf ako ukazovateľ pre kondenzáciu vody
- Šošovka 12: 1, prehľadný podsvietený displej.

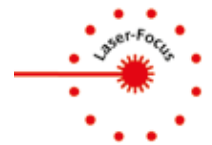
 Laser
650nm

Č.p. špecifikácia

	Rozsah merania infračerveným lúčom:	-40°C ... 365°C
	presnosť:	$\pm 40^{\circ}\text{C}$... 0°C ($\pm 1^{\circ}\text{C} + 0,1^{\circ}\text{C}$ [1°C]) 0°C ... 30°C ($\pm 1^{\circ}\text{C}$ or $\pm 1\%$, závisí na vyššej hodnote) $>30^{\circ}\text{C}$ ($\pm 2^{\circ}\text{C}$ or $\pm 2\%$, závisí na vyššej hodnote)
26528	Teplota okolia: presnosť:	-20°C ... 65°C $\pm 1^{\circ}\text{C}$ (0°C ... 50°C) $\pm 2,5^{\circ}\text{C}$ ($<0^{\circ}\text{C}$ and $>50^{\circ}\text{C}$)
	Vlhkosť vzduchu (relatívna): presnosť:	1%...99% $\pm 3\%$ (20%...80%) $\pm 5\%$ ($<20\%$ and $>80\%$)
	Dodávané s:	batérie

1

MULTIFINDER PLUS



Laserliner®

9V

AUTO
CALIBRATION

Univerzálny detektor pre vyhľadávanie dreva, kovu, medi, železa a živých vodičov

- Jednotlačidlové ovládanie pre prepínanie medzi rôznymi režimami merania
- Uživatelská príručka na LCD displeji pre jednoduché a spoľahlivé použitie
- Auto-calibration_ Hneď po zapnutí prispôsobí prístroj rôznym podkladom
- Auto-Cal Plus: Umožňuje jednoduché vymedzenie meraných objektov v režime vyhľadávania kovov
- Akustická a vizuálna detekcia signálov pri hľadaní objektov
- Vysoké zabezpečenie funkčnosti je vyriešené varovnými signálmi
- Zvláštne funkcie: V režime „kov“ je dokonca možné zistiť skryté drôty, ktoré nie sú pod napätím
- Podsvietenie displeja



1

Č.p. špecifikácia

26431 Dodávané s:

batérie

STARFINDER PLUS



Laserliner®

9V

AUTO
CALIBRATION

Elektronický detektor živých vedení

- Jednotlačidlové ovládanie pre prepínanie medzi rôznymi režimami merania
- Auto-Calibration: Hneď po zapnutí prispôsobí prístroj rôznym podkladom
- Akustická a vizuálna detekcia signálov pri hľadaní objektov
- Podsvietenie displeja

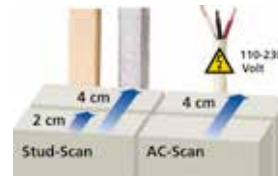

1

Č.p. špecifikácia

26429 Dodávané s:

batérie

COMBIFINDER PLUS



Laserliner®

9V

AUTO
CALIBRATION

Elektronický detektor kovov a živých vodičov

- Umožňuje ciele vyhľadávanie kovov ako je armovacie železo, kúrenárske a vodovodné potrubie
- Jednotlačidlové ovládanie pre prepínanie medzi rôznymi režimami merania
- Uživatelská príručka na LCD displeji pre jednoduché a spoľahlivé použitie
- Auto-calibration_ Hneď po zapnutí prispôsobí prístroj rôznym podkladom
- Auto-Cal Plus: Umožňuje jednoduché vymedzenie meraných objektov v režime vyhľadávania kovov
- Akustická a vizuálna detekcia signálov pri hľadaní objektov
- Vysoké zabezpečenie funkčnosti je vyriešené varovnými signálmi
- Podsvietený displej



1

Č.p. špecifikácia

26430 Dodávané s:

batérie

VIDEOSCOPE ONE

Kompaktná inšpekčná kamera pre vizuálnu kontrolu ťažko prístupných miest

- Hlava kamery s ohybným káblom zobrazuje priamo na LC monitore
- Výkonné osvetlenie vďaka 4 vysoko výkonným LED
- 2x digitálny zoom s krokmi po 10%
- DOF: Ohnisková vzdialenosť 3. . . 7 cm
- Externé monitory ovládané cez TV out pripojenie
- Kompaktná hlava kamery je dostatočne malá na to, aby sa dalo nazerať aj do neprístupných oblastí.
- Manuálne otáčanie obrazu o 180° na monitore
- Hlava kamery: \varnothing 9 mm

Laserliner®

DISPLAY
2,7 LCD320 x 240
pixelZOOM
2x

4x AA

IP 67

LED
light1,5m
 \varnothing 9 mm

1

Č.p. špecifikácia

26523 Dodávané s: VideoScope One 1,5 m, batérie

DISTANCECHECK



Laserový merač vzdialenosti, jednoduché ovládanie

- Vnútorný rozsah merania 0,05 - 20 m
- Presnosť merania ± 2 mm (typická)
- Funkcia výpočtu plochy a objemu umožňuje ľahký výpočet použitia množstva materiálov
- Priebežné merania min. | max.
- Osvetlený displej otočný o 180°

Laserliner®



Č.p. špecifikácia

26524 Dodávané s: batérie

1

LASERRANGE-MASTER T3



Laserový merač vzdialenosti - meranie danej vzdialenosti

- Funkcia výpočtu polohy a objemu umožňuje ľahký výpočet použitia množstva materiálov
- Pytagorova veta 1 + 2, funkcie uhla 1 + 2, meranie priebežné
- Snímač sklonu 360 st. pre určenie vertikálnej a horizontálnej vzdialenosti
- 1/4" závit
- Osvetlený 3 riadkový farebný LCD displej s dotykovou funkciou

Laserliner®



Č.p. špecifikácia

26395 Dodávané s: brašňa, batérie

1

COMPACTCROSS - LASER PLUS



Automatický krížový laser na vyrovnávanie dlaždíc, hrazdeného muriva, okien, dverí atď.

- Doplnkový režim sklonu umožňuje osadzovať tiež plochy so spádom
- RX-Ready: integrovaný režim ručného prijímača
- Rozhranie Bluetooth® * pre diaľkové ovládanie prístroja
- Rozsah samočinnej nivelácie 4° , Presnosť 0,35 mm | m

Laserliner®



Č.p. špecifikácia

26037 Dodávané s: batérie

1

SMARTCROSS-LASER



Automatický krížový laser s pridanou funkciou sklonu

- 5° samonivelačný rozsah, presnosť 0,5 mm | 1 m
- Funkcia sklonu umožňuje uzamknúť kyvadlový systém pre nakláňanie prístroja a vypustenie lúčov pod ľubovoľným uhlom
- Out of Level: je indikácia pomocou optických signálov, keď je jednotka mimo samonivelačný rozsah.
- Jednoduchá, konzistentná prevádzka

Laserliner®



Laser
650nm



Č.p. špecifikácia

26440 Dodávané s: SmartCross-Laser, batérie

1

FLEXCLAMP



Univerzálna svorka

- Vhodné pre všetky laserové prístroje s 1/4" závitom
- Ukotvenie k povrchu bez jeho poškodenia
- Výška a postavenie meracieho prístroja sú ľahko nastaviteľné

Laserliner®



Č.p. špecifikácia

26441 FlexClamp

1

AUTOCROSS - LASER 3C PLUS



Krížový laser pre vertikálne i horizontálne vyrovnávanie

- Presné polohovanie laserových línií vďaka otočnému telesu s jemným stranovým nastavením.
- Nastavovacie nohy s odnímateľnými gumovými krytkami
- Rozsah samočinnej nivelácie 2,5°, Presnosť 0,2 mm | m
- Jednoduchá a presná funkcia olovnice s prídavnou laserovou olovnicou dole a laserovým krížom hore
- Vertikálne laserové línie sú voči sebe vyrovnané pravouhlo

Laserliner®



Laser
635nm



Č.p. špecifikácia

26526 Dodávané s: batérie

1

SUPERSQUARE-LASER 4

Laserliner®



90° čiarový laser - ideálny pre pokládku obkladov a dlažieb

- Presnosť premietnutého uhla 0,5 mm | 1 m
- 4 dobre viditeľné laserové línie sú ideálne pre vyrovnanie obkladov
- Vertikálne a horizontálne vyrovnanie na stenách
- Ľahko sa zaistí rovná hrana umiestnených dlaždíc
- Čistá aplikácia na všetkých povrchoch pomocou štipcov
- Libela pre nastavenie zariadenia
- Môže byť použitý ako laserová vodováha



Č.p. špecifikácia

26495 Dodávané s: štipce, batérie

1

HANDYLASER PLUS

Laserliner®



Kompaktná univerzálna laserová vodováha

- Kombinuje výhody laserovej vodováhy s malými vonkajšími rozmermi
- Presnosť libiel 0,5 mm | 1 m
- Vertikálne vyrovnanie
- S vysoko presným hranolom



Č.p. špecifikácia

26493 Dodávané s: nastaviteľné nožičy, 90° pentagonálny hranol, batérie

1

OKULIARE ZJASŇUJÚCE LASEROVÝ PAPSOK

Laserliner®



Č.p. špecifikácia

26021 červené



1

ZNAČKOVAČ HÍBKOVÝ HB



Č.p. špecifikácia

13262	150 mm	20
13263	náhradné tuhy 6 ks	20



CERUZKA S VYMENITELNOU TUHOU HB



Č.p. špecifikácia

13279	ceruzka + náhradná tuha HB	24
13284	náhradné tuhy 5 ks	20



CERUZKA TESÁRSKA HB

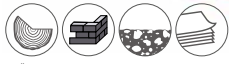

Č.p. špecifikácia

13270	HB · 180 mm	96
13271	HB · 180 mm · súprava 3 ks	32
13265	HB · 250 mm	96



MOQ 12



CERUZKA TESÁRSKA HB



Č.p. špecifikácia

13269	HB · 180 mm	50
13266	HB · 250 mm	50



MOQ 50



CERUZKA TESÁRSKA HB



Č.p. špecifikácia

13272	HB · 250 mm	96
13264	HB · 250 mm · bez potlača	96



MOQ 12



CERUZKA TESÁRSKA HB



Č.p. špecifikácia

13268	250 mm	50
-------	--------	----



MOQ 50



CERUZKA TROJHRANNÁ HB



Č.p. špecifikácia

13278	250 mm	96
-------	--------	----



MOQ 12



CERUZKA TESÁRSKA HB



Č.p. špecifikácia

13280	180 mm	96
-------	--------	----



MOQ 12



CERUZKA 6H



Č.p. 13275
špecifikácia 6H - 250 mm

MOQ 12



96

CERUZKA NA SKLO A KERAMIKU



Č.p. 13273
špecifikácia 175 mm červená tuha - sklo, keramika

MOQ 12



144

CERUZKA S FAREBNOU TUHOU



Č.p. 13274
špecifikácia 175 mm, červeno - modrá

MOQ 12



96

CERUZKA S ČERVENOU TUHOU



Č.p. 13276
špecifikácia 175 mm

MOQ 12



144

OREZÁVATKO NA CERUZKY



· šmirgel



Č.p. 13261

12

KRIEDA BIELA



Č.p. 13260
špecifikácia 12 x 12 x 80 mm

12x



46

ZNAČKOVAČ UNIVERZÁLNY SÚPRAVA 5 KS



· Ø 13 x 110 mm

Č.p.	špecifikácia	20
13240	5 farieb	20
13241	červená	20
13242	čierna	20

Č.p.	špecifikácia	20
13243	žltá	20
13244	zelená	20
13245	biela	20



CERUZKY VOSKOVÉ SÚPRAVA 6 KS



Č.p. 13277
špecifikácia



88

ZNAČKOVAČ PERMANENTNÝ



- extra silný hrot
- pre značenie aj na mastných a vlhkých povrchoch



MOQ
12

Č.p.	špecifikácia	
13216	červená	12
13217	čierna	12
13218	modrá	12
13219	zelená	12



ZNAČKOVAČ PERMANENTNÝ



- 2 typy hrotu značkovača
- pre značenie aj na mastných a vlhkých povrchoch



Č.p.	špecifikácia	
13227	biela ALU púzdro	40
13222	biela PVC púzdro	12
13228	červená ALU púzdro	40
13229	čierna ALU púzdro	40
13230	modrá ALU púzdro	12
13231	zelená ALU púzdro	12



ZNAČKOVAČ PERMANENTNÝ



MOQ
12

Č.p.	špecifikácia	
13214	biela	12
13225	červená	12
13226	čierna	12
13223	modrá	12
13224	zelená	12



ZNAČKOVAČ PERMANENTNÝ



MOQ
12

Č.p.	špecifikácia	
13235	červená	12
13236	čierna	12
13237	modrá	12
13238	zelená	12



ZNAČKOVAC PERMANENTNÝ, OBOJSTRANNÝ



ø 0,5 mm

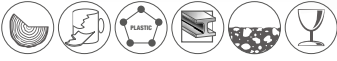

Č.p. 13212
špecifikácia čierny

MOQ 12



12

ZNAČKOVAC PERMANENTNÝ MINI

· dĺžka fixy 9 cm

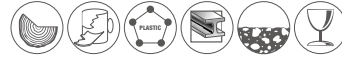

Č.p. 13205
špecifikácia

MOQ 72



72

IHLA RYSOVACIA



Č.p. 13281
špecifikácia 150 mm



50

KRUŽIDLO RYSOVACIE



Č.p. 13285
špecifikácia 200 mm



10

IHLA RYSOVACIA



Č.p. 13282
špecifikácia 200 mm



50



SPREJ FLUORESCENČNÝ TRACKMARKER 500ML



- vysoká viditeľnosť - fluorescenčný pigment
- bezpečnostné viečko
- rýchloschnúci 10 min.
- trvanlivosť 3 mesiace
- použitie - betón, asfalt, tráva, štrk, piesok, kameň, drevo



Č.p.	špecifikácia	
13250	● žltý	12
13251	● červený	12
13252	● oranžový	12
13253	● zelený	12
13254	● ružový	12
13249	● modrý	12

SPREJ FLUORESCENČNÝ MARK 6M FLUO 500 ML



- vysoká viditeľnosť - fluorescenčný pigment
- bezpečnostné viečko
- rýchloschnúci 10 min.
- trvanlivosť 6 mesiacov
- použitie - betón, asfalt, tráva, štrk, piesok, kameň, drevo, sklo



Č.p.	špecifikácia	
13360	● žltý	12
13361	● červený	12
13362	● oranžový	12
13363	● zelený	12
13364	● ružový	12
13365	○ biely	12

SPREJ FLUORESCENČNÝ FLUO 500 ML



- vysoká viditeľnosť - fluorescenčný pigment
- bezpečnostné viečko
- rýchloschnúci 10 min.
- trvanlivosť 12 mesiacov
- použitie - betón, asfalt, tráva, štrk, piesok, kameň, drevo, sklo



Č.p.	špecifikácia	
13350	● žltý	12
13351	● červený	12
13352	● oranžový	12
13353	● zelený	12
13354	● ružový	12
13355	○ biely	12

SPREJ FLUORESCENČNÝ IDEAL 500 ML



- vysoká viditeľnosť - fluorescenčný pigment
- bezpečnostné viečko
- rýchloschnúci 10 min.
- trvanlivosť 12 mesiacov
- použitie - betón, asfalt, tráva, štrk, piesok, kameň, drevo



Č.p.	špecifikácia	
13255	● žltý	12
13256	● červený	12
13257	● oranžový	12
13258	● zelený	12
13259	● ružový	12

DRŽIAK NA SPREJ SOPPEC



DRŽIAK NA NA SPREJ SOPPEC



- Pre rozprašovače Trackmarker a Fluo

Č.p.	špecifikácia	
13296		1

- Pre rozprašovače Trackmarker a Fluo

Č.p.	špecifikácia	
13295		1



40

KLIESTE



44

SIKO KLIESTE, HASÁKY



47

KLIESTE PÁKOVÉ



48

NOŽNICE NA PLECH, NOŽNICE TECHNICKÉ



51

GOLA SADY A RAČNE



59

HLAVICE, NADSTAVCE. ADAPTÉRY



65

KLÚČE



71

SKRUTKOVÁČE



78

BITY



84

INBUSY, SADY



89

KLADIVÁ, PALICE



93

GUMOVÉ ŠÚLKY

DIELENSKÉ NÁRADIE

38 - 133



95

SEKERY



97

PÁČIDLÁ



98

SEKÁČE, DLÁTA



101

SPONKOVAČKY



107

SVORKY A ZVERÁKY



109

PRACOVNÉ STOLY



110

KLIESTE NITOVACIE



114

ZVÁRANIE

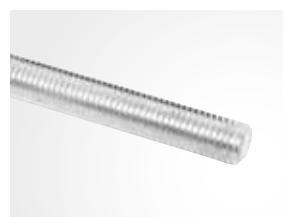

117

ZÁVITOVÉ TYČE, PODLOŽKY, MATICE



118

KOMPRESORY, ŠTRIEKACIE A
OFUKOVACIE PIŠTOLE

123

OCHRANNÉ POMÔCKY



129

NÁRAĎOVÉ PÁSY, BRAŠNE A PÚZDRA



ERGONOMIC handle



STANDARD

+30%

FESTA

KLIEŠTE KOMBINOVANÉ

FESTA



DIN 5746

CrV · chróm vanadiová oceľ

HRC 58-62 · tvrdosť čel'ustí



ERGONOMIC HANDLE · ergonomické rukoväte z kvalitnej TPE gúmy

indukčne tvrdené

Č.p.	špecifikácia	
17101	160 mm	6
17102	180 mm	6
17103	200 mm	6

KLIEŠTE BOČNÉ ŠTIEPACIE

FESTA

NEW

DIN 5749 TUV GS

CrV HRC 58-62



Č.p.	špecifikácia	
17148	180 mm	6

KLIEŠTE BOČNÉ ŠTIEPACIE

FESTA

DIN 5749 TUV GS

CrV HRC 58-62



Č.p.	špecifikácia	
17104	160 mm	6
17105	180 mm	6

KLIEŠTE RÁDIOVÉ

FESTA

DIN 5745 TUV GS

CrV HRC 58-62



Č.p.	špecifikácia	
17140	160 mm	6
17141	180 mm	6
17142	200 mm	6

KLIEŠTE RÁDIOVÉ ZAHNUTÉ

FESTA

DIN 5745 TUV GS

CrV HRC 58-62



Č.p.	špecifikácia	
17145	160 mm	6
17146	200 mm	6

KLIESTE KOMBINOVANÉ

DIN 5746

FESTA

HRC 50-55



Č.p.	špecifikácia	
17001	160 mm	6
17002	180 mm	6
17003	200 mm	6

KLIESTE BOČNÉ ŠTIEPACIE

DIN 5749

FESTA

HRC 50-55



Č.p.	špecifikácia	
17004	160 mm	6
17005	180 mm	6

KLIESTE BOČNÉ ŠTIEPACIE HEAVY DUTY

DIN 5749

FESTA

HRC 50-55



Č.p.	špecifikácia	
17108	180 mm	6

KLIESTE ŠTIEPACIE ČELNÉ

DIN 5749

FESTA

HRC 50-55



Č.p.	špecifikácia	
17110	160 mm	6

KLIESTE RÁDIOVÉ

DIN 5745

FESTA

HRC 50-55



Č.p.	špecifikácia	
17006	160 mm	6
17011	200 mm	6

KLIESTE RÁDIOVÉ ZAHNUTÉ

DIN 5745

FESTA

HRC 50-55



Č.p.	špecifikácia	
17007	160 mm	6
17008	200 mm	6

KLIESTE PLOCHÉ

DIN 5746

FESTA

HRC 50-55



Č.p.	špecifikácia	
17009	160 mm	6

KLIESTE OČKOVÉ

DIN 5745

FESTA

HRC 50-55



Č.p.	špecifikácia	
17010	160 mm	6

KLIESTE ODIZOLOVÁVACIE

DIN 5744

FESTA



Č.p.	špecifikácia	
17024	160 mm	6

KLIESTE KOMBINOVANÉ

DIN 5746



Č.p.	špecifikácia	
17094	160 mm	6
17095	180 mm	6
17096	200 mm	6

KLIESTE BOČNÉ ŠTIEPACIE

DIN 5749



Č.p.	špecifikácia	
17097	160 mm	6
17098	180 mm	6

KLIESTE RÁDIOVÉ

DIN 5745



Č.p.	špecifikácia	
17099	160 mm	6
17100	200 mm	6

VDE KLIŠTE KOMBINOVANÉ

DIN 5746

FESTA

CrV HRC 58-62



1000 V IEC/EN60900:2004

Č.p.	špecifikácia	
17125	160 mm	6
17126	180 mm	6
17127	200 mm	6



VDE KLIŠTE BOČNÉ ŠTIEPACIE

DIN 5749

FESTA

CrV HRC 58-62



1000 V IEC/EN60900:2004

Č.p.	špecifikácia	
17128	160 mm	6



VDE KLIŠTE KÁBLOVÉ ŠTIEPACIE

CrV HRC 58-62

FESTA



1000 V IEC/EN60900:2004

Č.p.	špecifikácia	
17130	160 mm	6



VDE KLIŠTE RÁDIOVÉ

DIN 5745

FESTA

CrV HRC 58-62



1000 V IEC/EN60900:2004

Č.p.	špecifikácia	
17133	160 mm	6



VDE KLIŠTE RÁDIOVÉ ZAHNUTÉ

DIN 5745

FESTA

CrV HRC 58-62



1000 V IEC/EN60900:2004

Č.p.	špecifikácia	
17135	160 mm	6



VDE KLIŠTE OČKOVÉ

DIN 5745

FESTA

CrV HRC 58-62



1000 V IEC/EN60900:2004

Č.p.	špecifikácia	
17137	160 mm	6



VDE KLIŠTE ODIZOLOVÁVACIE

FESTA

CrV DIN 5744



1000 V IEC/EN60900:2004

Č.p.	špecifikácia	
17138	160 mm	6



KLIŠTE ODIZOLOVÁVACIE



Č.p.	špecifikácia	
17180	Ø 0,75 - 2,5 mm	12



KLIŠTE ODIZOLOVÁVACIE



Č.p.	špecifikácia	
17181	Ø 0,60 - 2,6 mm	10



KLIŠTE MULTIFUNKČNÉ

CrV

FESTA



- 9 funkcií
- púzdro

Č.p.	špecifikácia
16232	



KLIESTE MINI SÚPRAVA

4x



Č.p. špecifikácia

17040

FESTA



12

KLIESTE KOMBINOVANÉ MINI

FESTA



Č.p. špecifikácia

17041 110 mm



12

KLIESTE BOČNÉ ŠTIEPACIE MINI

FESTA



Č.p. špecifikácia

17042 110 mm

12

KLIESTE ŠTIEPACIE ČELNÉ MINI

FESTA



Č.p. špecifikácia

17043 100 mm

12

KLIESTE RÁDIOVÉ MINI

FESTA



Č.p. špecifikácia

17044 120 mm

12

KLIESTE OČKOVÉ

MINI **FESTA**



Č.p. špecifikácia

17045 120 mm

12

KLIESTE SEGEROVÉ

FESTA



Č.p. špecifikácia

17190 180 mm vnútorné
17191 180 mm vonkajšie

6

KLIESTE SEGEROVÉ

FESTA



Č.p. špecifikácia

17192 180 mm vnútorné
17193 180 mm vonkajšie

15

15

KLIESTE SEGEROVÉ



Č.p. špecifikácia

17025 súprava

10

KLIESTE MULTIFUNKČNÉ

CrV



· pre montáž oplotenia

Č.p. špecifikácia

17109 270 mm

4

KLIŠTE SIKO S TLAČIDLOM

FESTA

KLIŠTE SIKO AUTOMATICKY NASTAVITELNÉ

FESTA

CrV

CrV



Č.p.	špecifikácia	rozsah čelustí	
17059	180 mm	0 - 30 mm	6
17061	250 mm	0 - 30 mm	6
17062	300 mm	0 - 40 mm	10
17080	400 mm	0 - 84 mm	10

Č.p.	špecifikácia	rozsah čelustí	
17079	250 mm	0 - 50 mm	6

KLIŠTE SIKO

FESTA

KLIŠTE SIKO

FESTA

KLIŠTE SIKO S TLAČIDLOM

FESTA

CrV

CrV

CrV



· veľký rozsah čelustí

Č.p.	špecifikácia	rozsah čelustí	
17086	250 mm	0 - 45 mm	6

Č.p.	špecifikácia	rozsah čelustí	
17081	180 mm	0 - 30 mm	6
17014	250 mm	0 - 30 mm	6
17082	300 mm	0 - 50 mm	6

Č.p.	špecifikácia	rozsah čelustí	
17084	250 mm	0 - 30 mm	6

KLIŠTE SIKO

FESTA

KLIŠTE SIKO

ČELUSTE PLASTOVÉ PRE KLIŠTE SIKO

CrV



· vhodné pre 17061, 17079, 17086

Č.p.	špecifikácia	rozsah čelustí	
17012	250 mm	0 - 40 mm	6
17060	300 mm	0 - 50 mm	10

Č.p.	špecifikácia	rozsah čelustí	
17013	250 mm	0 - 30 mm	6
17033 NEW	300 mm	0 - 50 mm	6

Č.p.	špecifikácia	
17085	1 pár	1

HASÁK 45°, S

CrV



Č.p.	špecifikácia	
17067	1" 330 mm	25
17068	1,5" 420 mm	18
17069	2" 540 mm	8

HASÁK 90°

CrV



Č.p.	špecifikácia	
17075	1" 330 mm	24
17076	1,5" 420 mm	20
17077	2" 540 mm	10

HASÁK 90°

CrV



Č.p.	špecifikácia	
17070	2,5" 355 mm	12
17071	3" 455 mm	8
17072	3,5" 610 mm	10

HASÁK S NASTAVOVACOU SKRUTKOU

HASÁK S VODIACOU MATICOU

CrV



Č.p.	špecifikácia		Č.p.	špecifikácia	
17063	230 mm	6	17065	260 mm	36
17064	300 mm	6	17066	300 mm	36

KLIESTE RÝCHLOUPÍNACIE

NEW



Č.p.	špecifikácia
17034	220 mm

5

KLIESTE RÝCHLOUPÍNACIE



Č.p.	špecifikácia
17036	260 mm

5

KLIESTE RÝCHLOUPÍNACIE



Č.p.	špecifikácia
17035	220 mm

10

KLIESTE RÝCHLOUPÍNACIE



Č.p.	špecifikácia
17023	220 mm

6

KLIESTE ŠTIEPACIE ČELNÉ

FESTA®

CrV



Č.p.	špecifikácia
17300	160 mm
17301	180 mm
17302	200 mm

6

6

6

KLIESTE RABITOVÉ

FESTA®

CrV



Č.p.	špecifikácia
17305	220 mm
17304	275 mm

10

6

KLIESTE ŠTIEPACIE ČELNÉ



Č.p.	špecifikácia
17015	160 mm
17016	180 mm
17017	200 mm

6

10

7

KLIESTE RABITOVÉ



Č.p.	špecifikácia
17019	220 mm
17083	275 mm

7

6

PÁKOVÉ ŠTIEPACIE KLIESTE PROFESIONÁLNE

FESTA

Cr-Mo

HRC 58-62



· čeľuste na káble a lanká



Č.p.	špecifikácia	max. Ø drôtu	max. Ø lanka	max. Ø kábla	
17055	14' 360 mm	max. 5 mm < 45 HRC	max. 3,5 mm	max. 8 mm	1
17056	18' 460 mm	max. 6 mm < 45 HRC	max. 5 mm	max. 10 mm	1
17057	24' 610 mm	max. 8 mm < 45 HRC	max. 7 mm	max. 12 mm	1
17058	30' 760 mm	max. 10 mm < 45 HRC	max. 9 mm	max. 14 mm	1
17046 NEW	35' 900 mm	max. 12 mm < 45 HRC	max. 10 mm	max. 16 mm	1

PÁKOVÉ ŠTIEPACIE KLIESTE PROFESIONÁLNE

FESTA

Cr-Mo

HRC 58-62



PÁKOVÉ ŠTIEPACIE KLIESTE



Č.p.	špecifikácia	max. Ø drôtu	
17051	14' 360 mm	max. 5 mm < 45 HRC	20
17052	18' 450 mm	max. 6 mm < 45 HRC	10
17053	24' 610 mm	max. 8 mm < 45 HRC	8
17054	30' 760 mm	max. 10 mm < 45 HRC	5
17048	36' 910 mm	max. 12 mm < 45 HRC	1

Č.p.	špecifikácia	max. Ø drôtu	
17028	14' 350 mm	max. 5 mm < 30 HRC	30
17020	18' 450 mm	max. 6 mm < 30 HRC	6
17021	24' 610 mm	max. 8 mm < 30 HRC	10
17022	30' 760 mm	max. 10 mm < 30 HRC	5

KLIESTE NA LANKÁ

FESTA

CrV

**max. Ø
6 mm**

- oceľové drôty
- ACSR káble
- letecké káble

KLIESTE NA LANKÁ

FESTA

CrV

**max. Ø
12 mm**

- oceľové drôty
- ACSR káble
- letecké káble

PÁKOVÉ ŠTIEPACIE KLIESTE

**max. Ø
5 mm**



Č.p.	špecifikácia	
17029	200 mm	6

Č.p.	špecifikácia	
17039	24' 610 mm	8

Č.p.	špecifikácia	
17038	8' 210 mm	6

KLIŠTE KLAMPIARSKÉ ROVNÉ

FESTA

NEW



Č.p.	špecifikácia
17089	150 x 215 mm



KLIŠTE KLAMPIARSKÉ ROVNÉ

FESTA

KLIŠTE KLAMPIARSKÉ ROVNÉ

FESTA



Č.p.	špecifikácia
17093	95 x 270 mm



6



Č.p.	špecifikácia
17090	60 x 280 mm



10

KLIŠTE KLAMPIARSKÉ VYHNUTÉ 45°

FESTA

KLIŠTE KLAMPIARSKÉ VYHNUTÉ 90°

FESTA



Č.p.	špecifikácia
17091	60 x 280 mm



10



Č.p.	špecifikácia
17092	60 x 260 mm



10

NOŽNICE NA PLECH

FESTA

NOŽNICE NA PLECH

FESTA

Cr-Mo

Cr-Mo

HRC 58-62

HRC 58-62



Č.p.	špecifikácia	
17112	rovné	40 260 mm
17117	pravé	40 260 mm
17122	ľavé	40 260 mm



6



Č.p.	špecifikácia	
17111	rovné	40 250 mm
17116	pravé	40 250 mm
17121	ľavé	40 250 mm



6

NOŽNICE NA PLECH

CrV

FESTA



Č.p.	špecifikácia	
17170	50 250 mm	6

NOŽNICE NA PLECH

CrV

FESTA



Č.p.	špecifikácia	
17156	60 245 mm	6

NOŽNICE NA PLECH

CrV

FESTA



Č.p.	špecifikácia	
17155	70 260 mm	6

NOŽNICE NA PLECH

CrV



Č.p.	špecifikácia	
17167	70 300 mm	5

NOŽNICE NA PLECH

CrV



Č.p.	špecifikácia	
17165	60 250 mm	5

NOŽNICE NA PLECH

CrV



Č.p.	špecifikácia	
17169	35 250 mm	5

NOŽNICE PRESTRHÁVACIE NA PLECH

max 0,8 mm



Č.p.	špecifikácia	
17186	265 mm	1

NÁSTAVEC NA STRIHANIE PLECHU

Max. hrúbka plechu

- 1,8 mm - oceľ
- 1,2 mm - nerez
- 2 mm - plasty, hliník, meď



Ø 8mm

Ø 4mm



Č.p.	špecifikácia	
20363		5

NOŽNICE PÁKOVÉ

17175	17177
max. 4mm	5mm
max. Ø10mm	Ø12mm
max. 8x8mm	10x10mm



860 mm



Č.p.	špecifikácia	
17175	150 mm	1
17177	250 mm	1

KLIÈŠTE DIEROVACIE

FESTA



Č.p. 17185
špecifikácia Ø 2; 2,5; 3; 3,5; 4; 4,5 mm

12

NOŽNICE NA PVC LIŠTY A RÚRKY

FESTA



· Použitie pre: lišty, rúrky, profily

Č.p. 17050
špecifikácia 60 | 220 mm ø 16 mm, ø 19 mm, ø 25 mm

8

NOŽNICE TECHNICKÉ

INOX



Č.p. 16420
špecifikácia 60 | 200 mm



10

NOŽNICE

INOX



Č.p. 17159
špecifikácia 65 | 220 mm



12

NOŽNICE TECHNICKÉ

INOX



Č.p. 17158
špecifikácia 50 | 150 mm



10

NOŽNICE - SÚPRAVA

INOX

3x



Č.p. 16401
špecifikácia 3 ks súprava



12

NOŽNICE

INOX



Č.p. 17160
špecifikácia 70 | 210 mm



12

NOŽNICE

INOX



Č.p. 16405 14 cm
16406 17 cm
16407 19 cm
16408 21,5 cm

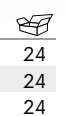

24
24
24
12

FESTA®

10 years
guarantee

- Použitie v priemysle a servisoch
- Kvalitná chróm vanadiová oceľ
- Račňa so 72 vybrúsenými zubami pre tú najpresnejšiu prácu
- Všetky komponenty podľa DIN normy
- Vrubkované hlavice pre zlepšenie úchopu
- Odolné plechové alebo plastové kufre

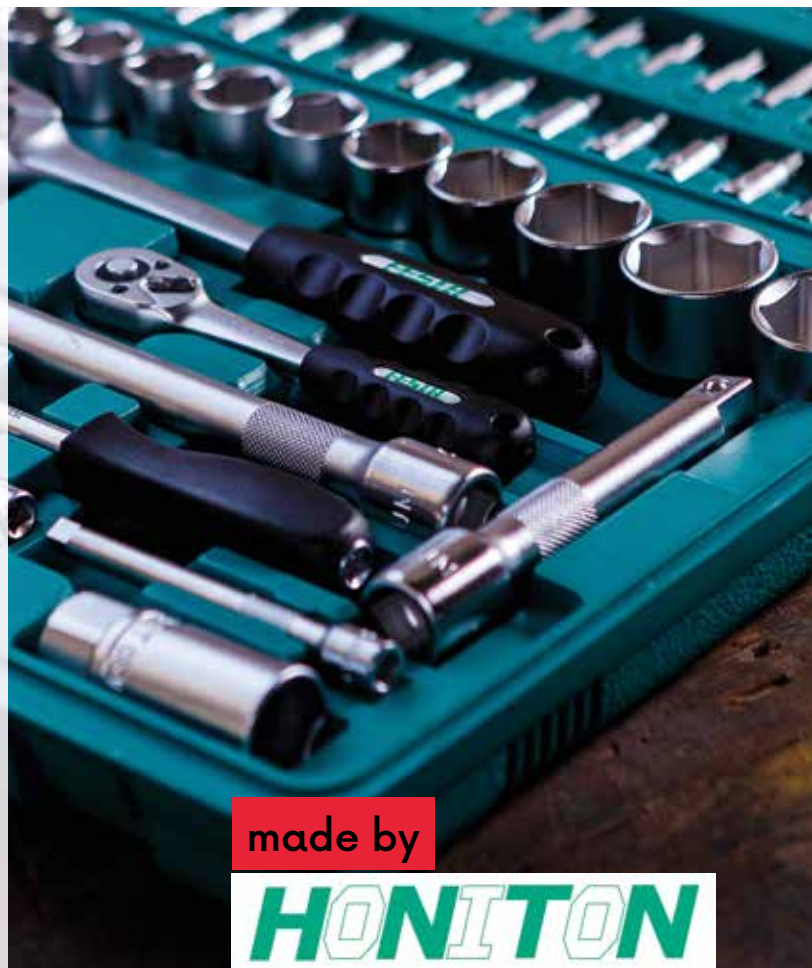

made by

HONITON

GOLA SADA

CrV

1/2"

13x



- 1/2" · 72 T
- 1/2" · 125 mm
- 1/2" · 8-9-10-11-12-13-14-15-17-19-22 mm

FESTA®
made by
HONITON

10 years
guarantee

Č.p. špecifikácia

17210



1

GOLA SADA

CrV

1/4"

17x



- 1/4" · 72 T
- 1/4" · 50 mm, 100 mm
- 1/4"
- 1/4"
- 1/4" · 4-4,5-5-5,5-6-7-8-9-10-11-12-13 mm

FESTA®
made by
HONITON

10 years
guarantee

Č.p. špecifikácia

17211



1

GOLA SADA

CrV

1/2"

25x



- 1/2"
- 1/2" · 125 mm, 250 mm
- 1/2"
- 16 mm, 21 mm
- 1/2"
- 1/2" · 10-11-12-13-14-15-16-17-18-19-20-21-22-23-24-27-30-32 mm

FESTA
made by
HONLTON



4

Č.p. špecifikácia

17212

GOLA SADA

CrV

1/2"

1/4"

59x



- 1/2", 1/4" · 72 T
- 1/2", 1/4"
- 1/4" · 150 mm
- 1/4" · 100 mm
- 1/2", 1/4"
- 1/2" · 125 mm, 250 mm
- 1/4" · 4-4,5-5-5,5-6-7-8-9-10-11-12-13 mm
- 1/2" · 10-11-12-13-14-15-17-19-21-22-24-27-30-32 mm
- 16 mm, 21 mm
- 18x
Inbus 3x

FESTA
made by
HONLTON



4

Č.p. špecifikácia

17214

GOLA SADA

CrV

1/2"

28x



- 1/2" · 72 T
- 1/2" · 125 mm, 250 mm
- 1/2"
- 16 mm, 21 mm
- 1/2"
- 1/2"
- 1/2" · 8-9-10-11-12-13-14-15-16-17-18-19-20-21-22-23-24-27-30-32 mm

FESTA
made by
HONLTON



4

Č.p. špecifikácia

17213

GOLA SADA

CrV

1/4"

16x



- 1/4" · 72 T
- 1/4" · 50 mm
- 1/4"
- 1/4"
- 1/4" · 4-4,5-5-5,5-6-7-8-9-10-11-12-13 mm

FESTA
made by
HONLTON



1

Č.p. špecifikácia

17215

GOLA SADA

CrV

1/2"

25x



- 1/2" · 72 T
- 1/2" · 125 mm, 250 mm
- 1/2"
- 16 mm, 21 mm
- 1/2"
- 1/2" · 10-11-12-13-14-15-16-17-18-19-20-21-22-23-24-27-30-32 mm

FESTA
made by
HENITON



Č.p. špecifikácia

17216



10

GOLA SADA

CrV

1/4"

32x



- 1/4" · 72 T
- 1/4" · 50 mm
- 1/4"
- 1/4"
- 1/4"
- 1/4" · 4-4,5-5-5,5-6-7-8-9-10-11-12-13 mm
- 12x
- Inbus 3x

FESTA
made by
HENITON



Č.p. špecifikácia

17217



1

GOLA SADA

CrV

1/4"

1/2"

56x



- 1/2", 1/4" · 72 T
- 1/2", 1/4"
- 1/4" 150 mm
- 1/4" 100 mm
- 1/2", 1/4"
- 1/2" · 125 mm, 250 mm
- 1/4" · 4-4,5-5-5,5-6-7-8-9-10-11-12-13 mm
- 1/2" · 10-11-12-13-14-15-17-19-21-22-24-27-30-32 mm
- 16 mm, 21 mm
- 16x
- Inbus 3x

FESTA
made by
HENITON



Č.p. špecifikácia

17218



4

GOLA SADA

CrV

1/4"

1/2"

94x



- 1/2", 1/4" · 72 T
- 1/2", 1/4"
- 1/4"
- 1/4" · 50 mm, 100 mm
- 1/2", 1/4"
- 1/2", 1/4"
- 1/2" 125 mm, 250 mm
- 1/4" · 4-4,5-5-5,5-6-7-8-9-10-11-12-13-14 mm
- 1/2" · 10-11-12-13-14-15-17-19-21-22-24-27-30-32 mm
- 1/4" · 6-7-8-9-10-11-12-13 mm
- 1/2" · 14-15-17-19-22 mm
- 16 mm, 21 mm
- 34x
- Inbus 3x

FESTA
made by
HENITON



Č.p. špecifikácia

17219



3

GOLA SADA

CrV

1/2"

27x



- 1/2" · 72 T
- 1/2" · 125 mm, 250 mm
- 1/2"
- 16 mm, 21 mm
- 1/2"
- 1/2" · 8-9-10-11-12-13-14-15-16-17-18-19-20-21-22-23-24-27-30-32 mm

FESTA
made by
HUNTON



Č.p. špecifikácia

17225



4

GOLA SADA

CrV

3/4"

14x



- 3/4" · 72 T
- 3/4" · 100 mm, 200 mm
- 3/4" · 460 mm
- 3/4" · 22-24-27-30-32-36-38-41-46-50 mm

FESTA
made by
HUNTON



Č.p. špecifikácia

17226



1

GOLA SADA

CrV

3/4"

21x



- 3/4" · 72 T
- 3/4" · 100 mm, 200 mm, 400 mm
- 3/4" · 460 mm
- 3/4" · 19-21-22-23-24-26-27-29-30-32-35-36-38-41-46-50 mm

FESTA
made by
HUNTON



Č.p. špecifikácia

17227



1

SADA HLAVÍC INBUS

CrV

1/2"

9x



FESTA
made by
HUNTON



SADA HLAVÍC TORX

CrV

1/2"

9x



FESTA
made by
HUNTON



- 1/2" HEX · 4-5-6-7-8 -10-12-14-17 mm

Č.p. špecifikácia

17345



1

- T20-T25-T27-T30-T40-T45-T50-T55-T60 mm

Č.p. špecifikácia

17346



1

HLAVICE NA KOLESÁ

Cr-Mo

1/2"

3x



FESTA
made by
HUNTON

10 years
guarantee



Č.p.	špecifikácia	
17336	17 mm	1
17337	19 mm	1
17338	21 mm	1

HLAVICE NA KOLESÁ

Cr-Mo

1/2"

3x



FESTA
made by
HUNTON

10 years
guarantee



1/2" · 17-19-21 mm

Č.p.	špecifikácia	
17335		1

RAČŇA

CrV



FESTA
made by
HUNTON

10 years
guarantee



Č.p.	špecifikácia	
17220	1/4" 36 zubov	20
17222	3/8" 36 zubov	10
17224	1/2" 36 zubov	6
17208	1/2" 72 zubov	6

SADA NÁSTRČNÝCH HLAVÍC DRIVELOCK

CrV

1/4"

12x



4-5-5,5-6-7-8-9-10-11-12-13 mm

Č.p.	špecifikácia	
17250		10



SADA NÁSTRČNÝCH HLAVÍC TORX

CrV

1/2"

1/4"

9x



	1/4" · 5-6-7-8-10	
	1/2" · 12-14-16-18	

Č.p.	špecifikácia	
17255		4

FESTA®

10 years guarantee



Cr-Mo

- Použitie v priemysle a servisoch
- Vysoko kvalitná chróm vanadiová oceľ
- Račňa so 72 vybrúsenými zubami pre tú najpresnejšiu prácu
- Všetky komponenty podľa DIN normy
- Vrúbkované hlavice pre zlepšenie úchopu
- Odolný kufor s kovovými zámkami a kovovými pántami



SADA NÁRADIA

FESTA®

NEW

- CrV
- S2
- 1/4"
- 1/2"
- 72T
- 122x
- ERGO HANDLE



- | | |
|--|--|
| 1/2", 1/4" | 1/4" · S 4 · 5,5 · 6,5 |
| 1/4" · 4-5-6-7-8-9mm | 1/4" · PH 1 · 2 · 3 |
| 1/2" · 10-12-13-14-17-19mm | 1/4" · PZ 2 · 3 |
| 1/4" · 4-4.5-5-5.5-6-7-8-9-10-11-12-13-14mm | 1/4" · H 3 · 4 · 5 · 6 |
| 1/2" · 12-13-14-15-16-17-18-19-20-21-22-24mm | 1/4" · T 8 · 10 · 15 · 20 · 25 |
| 1/2", 1/4" | 1/4" · TTα 10 · 15 · 20 · 25 · 40 |
| 1/4" · | 2 · 2,5 · 3 · 4 · 5 · 6 · 7 · 8 · 10mm |
| 1/4" · 150mm | 8-9-10-11-12-13-14-15-16-17-18-19mm |
| 1/2" · 254mm | S 4x100 · 6,5x150 |
| 1/2", 1/4" | PH 2x100 · 3x150 |
| 1/2" · 16-21mm | 180mm |
| 1/4" · 150mm | 160mm |
| 1/2" · E10-E12-E14-E16-E18-E20-E22-E24 | 160mm |
| 1/4" · S 3 · 4 · 5 · 6 | 250mm |
| 1/4" · PH 0 · 1 · 2 | 300g |
| 1/4" · PZ 0 · 1 · 2 | |

Č.p. 17238
špecifikácia 122 ks



GOLA SADA

FESTA®

- CrV
- 1/2"
- 72T
- 12x
- ERGO HANDLE



10 years guarantee

- 1/2" · 72T
- 1/2" · 125 mm
- 1/2" · 10-11-12-13-14-15-17-19-22-24 mm



Č.p. 17245
špecifikácia

GOLA SADA

FESTA®

- CrV
- 1/2"
- 72T
- 12x
- ERGO HANDLE



10 years guarantee

- 1/2" · 72T
- 1/2" · 125 mm
- 1/2" · 10-11-12-13-14-15-17-19-22-24 mm



Č.p. 17229
špecifikácia

GOLA SADA

FESTA

- CrV
- 1/2"
- 72T
- 20x
- ERGO HANDLE



10 years guarantee

- 1/2" · 72 T
- 1/2" · 75, 125 mm
- 1/2"
- 1/2" · 10-11-12-13-14-15-16-17-18-19-22-24 mm
- 1/2" · 17mm, 19mm
- 3 way adapter
- 16mm, 21mm



Č.p. špecifikácia

17230



4

GOLA SADA

FESTA

- CrV S2
- 1/4"
- 72T
- 36x
- ERGO HANDLE



10 years guarantee

- 1/4" · 72 T
- 1/4" · 50, 100 mm
- 1/4"
- 1/4" · 4-5-5,5-6-7-8-10-11-12-13 mm
- 1/4" · 6-7-8-10-12-13 mm
- 3 way adapter
- 4 x
- 11x
- 1x



Č.p. špecifikácia

17231



10

GOLA SADA

FESTA

- CrV S2
- 1/4"
- 72T
- 46x
- ERGO HANDLE



10 years guarantee

- 1/4"
- 1/4"
- 1/4" · 4-4,5-5-5,5-6-7-8-9-10-11-12-13-14 mm
- 1/4" · 50 mm, 100 mm
- 1/4"
- 1/4"
- 1/4"
- 21 x
- 1/4"
- 1/4"



Č.p. špecifikácia

17233



10

GOLA SADA

FESTA

- CrV S2
- 1/4"
- 1/2"
- 72T
- 73x
- ERGO HANDLE



10 years guarantee

- 1/2", 1/4" · 72T
- 1/4"
- 16 mm, 21 mm
- 1/4" · 10-11-12-13-14-15-16-17-18-19-20-21-22-23-24-27 mm
- 1/4" · 100 mm
- 1/2" · 125 mm, 250 mm
- 1/2"
- 1 x
- 1/4" · 4-5-5,5-6-7-8-10-11-12-13 mm
- 33 x



Č.p. špecifikácia

17234



4



GOLA SADA



CrV S2

1/4"

1/2"



94x



- 1/2", 1/4" · 72T
- 1/4"
- 16 mm, 21 mm
- 1/4" · 4 -4,5-5-5,5-6-7-8-9-10-11-12-13-14 mm
- 1/2" · 10-11-12-13-14-15-16-17-18-19-20-21-22-23-24-27-30-32 mm
- 1/4" · 6-7-8-9-10-11-12-13 mm
- 1/2" · 14-15-17-19 mm
- 1/4" · 50 mm, 100 mm
- 1/2" · 125 mm, 250 mm
- 1/4"
- 5/16" bit holder
- 17x
- 15x
- 3 way adapter
- 3 x
- 1/4"
- L 1/4"
- 1/2", 1/4"

Č.p. špecifikácia

17235



4

GOLA SADA



CrV S2

1/4"

1/2"



110x



- 1/2", 1/4" · 72T
- 150 mm
- 16 mm, 21 mm
- 1/4" · 4 -4,5-5-5,5-6-7-8-9-10-11-12-13-14 mm
- 1/2" · 10-11-12-13-14-15-16-17-18-19-20-21-22-24-27-30-32 mm
- 1/4" · 6-7-8-9-10-11-12-13 mm
- 1/2" · 14-15-17-19-22 mm
- 1/4" · 50 mm, 100 mm
- 1/2" · 125 mm, 250 mm
- E · 4-5-6-7-8-10-11-12-14-16-18-20-24-27-30-32 mm
- 1/2", 1/4"
- 5/16" bit holder
- 18 x
- 17 x
- 3 way adapter
- 4 x
- 1/4"
- L 1/4"

Č.p. špecifikácia

17236



4

GOLA SADA



CrV S2

1/4"

1/2"

3/8"



171x



- 1/2", 1/4", 3/8"
- 1/4" · 4-5-6-7-8-9-10mm
- 3/8" · 10-11-12-13-14-15mm
- 1/2" · 16-17-18-19-22mm
- 1/4" · 4-4,5-5-5,5-6-7-8-9-10-11-12-13-14mm
- 3/8" · 10-11-12-13-14-15-16-17-18-19mm
- 1/2" · 10-11-12-13-14-15-16-17-18-19-20-21-22-24-27-30-32mm
- 1/4" · E4-E5-E6-E7-E8
- 3/8" · E10-E11-E12-E14-E16-E18
- 1/2" · E20-E24
- 1/2" · 24x
- 1/4" · 20x
- 1/4" · 30x
- 1/4" · 50 mm, 100 mm
- 1/2" · 125 mm, 250 mm
- 3/8" · 150 mm
- 1/2" · 16-21mm
- 3/8" · 18mm
- 1/2", 1/4", 3/8" bit holder
- 1/2", 1/4", 3/8"
- 1/4" · 150mm
- 1/4" · 115mm
- Inbus 7X

Č.p. špecifikácia

17237



2

FESTA®



RAČNE FESTA

- Račňa je vyrobená z najkvalitnejšej chrom vanadiovej ocele
- Račňa so 72 vybrúsenými zubami pre tú najpresnejšiu prácu
- Kvalitná, ergonomická, dvojkomponentná rukoväť z mäkkej TPE gummy
- SYSTÉM QUICK RELEASE pre ľahkú a rýchlu výmenu hlavíc



RAČŇA



Č.p.	špecifikácia	dĺžka	
17297	1/4"	155 mm	6
17298	3/8"	210 mm	5
17299	1/2"	255 mm	4

RAČŇA



Č.p.	špecifikácia	dĺžka	
17240	1/4"	155 mm	10
17241	3/8"	200 mm	10
17242	1/2"	250 mm	5

RAČŇA



Č.p.	špecifikácia	dĺžka	
17294	1/4"	155 mm	6
17295	3/8"	205 mm	10
17296	1/2"	255 mm	4

RAČŇA OTOČNÁ 1/4"

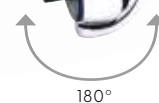

Č.p.	špecifikácia	
17292	1/4"	1

RAČŇA



HOBBY



Č.p.	špecifikácia	
17243	1/4"	25
17244	1/2"	25

SKRUTKOVÁČ NA HLAVICE

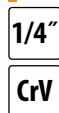

Č.p.	špecifikácia	
18603	1/4" 150 mm	10

HLAVICA UNIVERZÁLNA

CrV



1/2"



1/2"

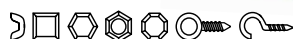

Č.p. 17811 špecifikácia pre skrutky 11 - 32mm • 83mm x ø43mm 5

HLAVICA UNIVERZÁLNA

CrV



3/8"



3/8"

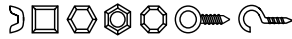

Č.p. 17810 špecifikácia pre skrutky 7 - 19mm • 52mm x ø26mm 1

HLAVICA 1/4"

FESTA

CrV



1/4"



Č.p.	špecifikácia	
17820	4 mm • 25 mm	10
17821	4,5 mm • 25 mm	10
17822	5 mm • 25 mm	10
17823	5,5 mm • 25 mm	10
17824	6 mm • 25 mm	10
17825	7 mm • 25 mm	10
17826	8 mm • 25 mm	10

Č.p.	špecifikácia	
17827	9 mm • 25 mm	10
17828	10 mm • 25 mm	10
17829	11 mm • 25 mm	10
17830	12 mm • 25 mm	10
17831	13 mm • 25 mm	10
17832	14 mm • 25 mm	10

HLAVICA PREDĹŽENÁ 1/4"

FESTA

CrV



1/4"



Č.p.	špecifikácia	
17860	4 mm • 70 mm	10
17861	5 mm • 70 mm	10
17862	6 mm • 70 mm	10
17863	7 mm • 70 mm	10
17864	8 mm • 70 mm	10
17865	9 mm • 70 mm	10

Č.p.	špecifikácia	
17866	10 mm • 70 mm	10
17867	11 mm • 70 mm	10
17868	12 mm • 70 mm	10
17869	13 mm • 70 mm	10
17870	14 mm • 70 mm	10

HLAVICA 1/2"

FESTA

CrV



1/2"



Č.p.	špecifikácia	
17308	8 mm • 38 mm	10
17309	9 mm • 38 mm	10
17310	10 mm • 38 mm	10
17311	11 mm • 38 mm	10
17312	12 mm • 38 mm	10
17313	13 mm • 38 mm	10
17314	14 mm • 38 mm	10
17315	15 mm • 38 mm	10
17316	16 mm • 38 mm	10
17317	17 mm • 38 mm	10
17318	18 mm • 38 mm	10

Č.p.	špecifikácia	
17319	19 mm • 38 mm	10
17320	20 mm • 38 mm	10
17321	21 mm • 38 mm	10
17322	22 mm • 38 mm	10
17324	24 mm • 38 mm	10
17327	27 mm • 42 mm	20
17330	30 mm • 42 mm	25
17332	32 mm • 42 mm	20
17333	34 mm • 42 mm	20
17334	36 mm • 42 mm	20

HLAVICA PREDĹŽENÁ 1/2"

FESTA

CrV



1/2"



Č.p.	špecifikácia	
17871	10 mm • 70 mm	10
17872	11 mm • 70 mm	10
17873	12 mm • 70 mm	10
17874	13 mm • 70 mm	10
17875	14 mm • 70 mm	10
17876	15 mm • 70 mm	10
17877	16 mm • 70 mm	10
17878	17 mm • 70 mm	10
17879	18 mm • 70 mm	10
17880	19 mm • 70 mm	10
17881	20 mm • 70 mm	10

Č.p.	špecifikácia	
17882	21 mm • 70 mm	10
17883	22 mm • 70 mm	10
17884	23 mm • 70 mm	10
17885	24 mm • 70 mm	10
17886	25 mm • 70 mm	10
17887	26 mm • 70 mm	10
17888	27 mm • 70 mm	10
17889	28 mm • 70 mm	10
17890	30 mm • 70 mm	10
17891	32 mm • 70 mm	10
17892	34 mm • 70 mm	10



HLAVICA 3/4"

FESTA

CrV



3/4"



Č.p.	špecifikácia		Č.p.	špecifikácia	
17835	17 mm · 48 mm	10	17846	33 mm · 55 mm	10
17836	18 mm · 48 mm	10	17847	36 mm · 60 mm	10
17837	19 mm · 48 mm	10	17848	38 mm · 60 mm	10
17838	21 mm · 48 mm	10	17849	41 mm · 65 mm	10
17839	22 mm · 48 mm	10	17850	46 mm · 65 mm	10
17840	24 mm · 48 mm	10	17851	50 mm · 70 mm	10
17841	26 mm · 48 mm	10	17852	55 mm · 75 mm	10
17842	27 mm · 52 mm	10	17853	60 mm · 78 mm	10
17843	28 mm · 52 mm	10	17854	65 mm · 82 mm	10
17844	30 mm · 52 mm	10	17855	70 mm · 82 mm	10
17845	32 mm · 52 mm	10	17856	75 mm · 88 mm	10

HLAVICA MULTILOCK 1/4"

FESTA

CrV



1/4"



Č.p.	špecifikácia		Č.p.	špecifikácia	
17895	4 mm · 25 mm	10	17902	9 mm · 25 mm	10
17896	4,5 mm · 25 mm	10	17904	11 mm · 25 mm	10
17897	5 mm · 25 mm	10	17905	12 mm · 25 mm	10
17898	5,5 mm · 25 mm	10	17907	14 mm · 25 mm	10
17900	7 mm · 25 mm	10			

HLAVICA MULTILOCK 1/2"

FESTA

CrV



1/2"



Č.p.	špecifikácia		Č.p.	špecifikácia	
17910	8 mm · 38 mm	10	17922	21 mm · 38 mm	10
17912	10 mm · 38 mm	10	17924	24 mm · 38 mm	10
17913	11 mm · 38 mm	10	17925	27 mm · 38 mm	10
17914	12 mm · 38 mm	10	17926	30 mm · 38 mm	10
17916	14 mm · 38 mm	10	17927	32 mm · 38 mm	10
17921	19 mm · 38 mm	10			

HLAVICA TORX 1/4"

FESTA

CrV



1/4"



Č.p.	špecifikácia		Č.p.	špecifikácia	
17930	E4	10	17933	E7	10
17931	E5	10	17934	E8	10
17932	E6	10	17935	E10	10

HLAVICA TORX 1/2"

FESTA

CrV



1/2"



Č.p.	špecifikácia	
17943	E22	10
17944	E24	10

NÁSTAVEC SKRUTKOVACÍ 1/4"

FESTA

CrV S2



1/4"



Č.p.	špecifikácia	
18920	4 mm	10
18921	5,5 mm	10
18922	7 mm	10

NÁSTAVEC SKRUTKOVACÍ 1/4"

FESTA

CrV S2



1/4"



Č.p.	špecifikácia	
18925	PH 1	10
18926	PH 2	10
18927	PH 3	10

NÁSTAVEC SKRUTKOVACÍ 1/4"

FESTA

CrV S2



1/4"



Č.p.	špecifikácia	
18928	PZ 0	10
18929	PZ 1	10
18930	PZ 2	10
18931	PZ 3	10

NÁSTAVEC SKRUTKOVACÍ 1/2"

FESTA

CrV S2



1/2"



Č.p.	špecifikácia		Č.p.	špecifikácia	
18967	M 8	10	18970	M 14	10
18968	M 10	10	18971	M 16	10
18969	M 12	10	18972	M 18	10

NÁSTAVEC SKRUTKOVACÍ 1/4"

FESTA

CrV S2



1/4"



Č.p.	špecifikácia		Č.p.	špecifikácia	
18934	3 mm	10	18937	6 mm	10
18935	4 mm	10	18939	8 mm	10

NÁSTAVEC SKRUTKOVACÍ 1/2"

FESTA

CrV S2



1/2"



Č.p.	špecifikácia		Č.p.	špecifikácia	
18944	12 mm	10			
18945	14 mm	10			

NÁSTAVEC SKRUTKOVACÍ 1/4"

FESTA

CrV S2



1/4"



Č.p.	špecifikácia	
18948	T 5	10
18950	T 8	10
18951	T 10	10

NÁSTAVEC SKRUTKOVACÍ 1/2"

FESTA

CrV S2



1/2"



Č.p.	špecifikácia		Č.p.	špecifikácia	
18954	T 10	10	18960	T 40	10
18955	T 15	10	18961	T 45	10
18956	T 20	10	18963	T 55	10
18957	T 25	10			

ADAPTÉR

CrV



Č.p.	špecifikácia	
17410	A - 1/4" B - 3/8"	10
17411	A - 3/8" B - 1/4"	10
17412	A - 3/8" B - 1/2"	10
17413	A - 1/2" B - 3/8"	10

Č.p.	špecifikácia	
17414	A - 1/2" B - 3/4"	10
17415	A - 3/4" B - 1/2"	10
17416	A - 1/4" B - 1/2"	10

KARDAN

CrV



Č.p.	špecifikácia	
17405	1/4" · 39 mm	10
17406	1/2" · 71 mm	10
17407	3/4" · 105 mm	10

JEZDEC NA „T“ VRATIDLO

CrV



Č.p.	špecifikácia	
17420	1/4"	1
17421	1/2"	1
17422	3/4"	1

„T“ VRATIDLO

CrV



Č.p.	špecifikácia	
17382	1/4" · 115 mm	1
17383	3/8" · 190 mm	1
17384	1/2" · 250 mm	1
17385	3/4" · 460 mm	1
17386	1' · 640 mm	1

"T" NADSTAVEC PREDĹŽENÝ S KÍLBOM

CrV



Č.p.	špecifikácia	
17401	1/4" · 250 mm	1
17402	1/2" · 400 mm	1



VRATIDLO KLBOVÉ - TRHÁK

FESTA

CrV



Č.p.	špecifikácia	
17380	1/2" · 350 mm	1
17381	3/4" · 500 mm	1

RUKOVĚŤ OHNUTÁ

FESTA

CrV

1/2"



Č.p.	špecifikácia	
17427	1/2" · 60 x 320 mm	1

NÁSTAVEC PREDLŽOVACÍ

FESTA

CrV



Č.p.	špecifikácia		Č.p.	špecifikácia	
17390	1/4" · 50 mm	1	17395	1/2" · 250 mm	1
17391	1/4" · 100 mm	1	17396	3/4" · 100 mm	1
17392	1/4" · 150 mm	1	17397	3/4" · 200 mm	1
17393	1/2" · 75 mm	1	17398	3/4" · 400 mm	1
17394	1/2" · 125 mm	1			

NÁSTAVEC FLEXIBILNÝ

FESTA

CrV

1/4"



Č.p.	špecifikácia	
17400	1/4" · 150 mm	1

ADAPTÉR RAČŇA 1/4" - BIT

Stahlberg

CrV



1/4" ↔ 1/4"

Č.p.	špecifikácia	
18619		5

SÚPRAVA ADAPTÉROV PRE VŔTAČKU

CrV



1/4"

3x



Č.p.	špecifikácia	
18604	1/4", 3/8", 1/2"	10

KLÍČ NA RADIÁTOROVÉ SKRUTKY

FESTA

CrV

1/2"



Č.p.	špecifikácia	
17455	pre račňu 1/2"	10

UNIVERZÁLNY KLÍČ K ROZVODNÝM SKRINIAM

FESTA

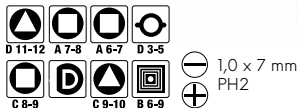

Č.p.	špecifikácia	
17456		50

FESTA®

- Kované kľúče z kvalitnej CrV ocele
- Vyrobené podľa DIN normy
- Chrómová povrchová úprava



KLÚČ OBOJSTRANNÝ OTVORENÝ

FESTA®

CrV

DIN 3110



Č.p.	špecifikácia	
17550	6 x 7 mm	10
17551	8 x 9 mm	10
17552	8 x 10 mm	10
17553	10 x 11 mm	10
17590	10 x 13 mm	10
17554	12 x 13 mm	10
17555	14 x 15 mm	10
17556	13 x 16 mm	10
17557	13 x 17 mm	10
17591	14 x 17 mm	10
17558	16 x 17 mm	10
17559	17 x 19 mm	10
17560	18 x 19 mm	10

Č.p.	špecifikácia	
17592	19 x 22 mm	10
17593	19 x 24 mm	10
17561	20 x 22 mm	10
17569	21 x 23 mm	10
17548	22 x 24 mm	10
17562	24 x 27 mm	10
17549	24 x 30 mm	10
17563	30 x 32 mm	10
17564	30 x 34 mm	10
17565	32 x 36 mm	10
17566	36 x 41 mm	10
17567	46 x 50 mm	10
17568	55 x 60 mm	3

KLÚČ OČKOPLOCHÝ

FESTA®

CrV

DIN 3113



Č.p.	špecifikácia	
17487	6 mm	10
17570	7 mm	10
17571	8 mm	10
17572	9 mm	10
17573	10 mm	10
17574	11 mm	10
17575	12 mm	10
17576	13 mm	10
17577	14 mm	10
17578	15 mm	10
17579	16 mm	10
17580	17 mm	10
17581	18 mm	10
17582	19 mm	10
17488	20 mm	10

Č.p.	špecifikácia	
17489	21 mm	10
17583	22 mm	10
17490	23 mm	10
17584	24 mm	10
17491	25 mm	10
17492	26 mm	10
17585	27 mm	10
17493	28 mm	10
17494	29 mm	10
17586	30 mm	10
17587	32 mm	10
17495	33 mm	10
17496	34 mm	10
17589	36 mm	10

KLÚČ RÁČNOVÝ KÍBOVÝ

FESTA®

CrV

72T



Č.p.	špecifikácia	
17628	8 mm	10
17622	10 mm	10
17623	13 mm	10
17624	14 mm	10
17629	15 mm	10
17630	16 mm	5

Č.p.	špecifikácia	
17625	17 mm	10
17631	18 mm	10
17626	19 mm	10
17632	21 mm	5
17633	22 mm	5

KLÚČ RÁČNOVÝ

FESTA®

CrV

72T



Č.p.	špecifikácia	
17660	6 mm	10
17676	7 mm	10
17661	8 mm	10
17662	9 mm	10
17663	10 mm	10
17664	11 mm	10
17665	12 mm	10
17666	13 mm	10
17667	14 mm	10
17668	15 mm	10

Č.p.	špecifikácia	
17669	16 mm	10
17670	17 mm	10
17671	18 mm	10
17672	19 mm	10
17674	21 mm	5
17675	22 mm	5
17677	24 mm	5
17678	27 mm	5
17679	30 mm	5
17683	32 mm	5

KLÚČ OČKOVÝ, VYHNUTÝ

FESTA

CrV

DIN 838



Č.p.	špecifikácia		Č.p.	špecifikácia	
17605	6 x 7 mm	10	17610	14 x 15 mm	10
17606	8 x 9 mm	10	17613	16 x 17 mm	10
17607	8 x 10 mm	10	17614	18 x 19 mm	10
17608	10 x 11 mm	10	17615	20 x 22 mm	10
17609	12 x 13 mm	10	17616	24 x 27 mm	10
17611	13 x 16 mm	10	17617	30 x 32 mm	10
17612	13 x 17 mm	10			

KLÚČ OBOJSTRANNÝ OTVORENÝ DIN 895

FESTA

DIN 895



Č.p.	špecifikácia		Č.p.	špecifikácia	
17460	6 x 7 mm	10	17469	17 x 19 mm	10
17461	8 x 9 mm	10	17470	18 x 19 mm	10
17462	8 x 10 mm	10	17483	19 x 22 mm	10
17463	10 x 11 mm	10	17484	19 x 24 mm	10
17481	10 x 13 mm	10	17471	20 x 22 mm	10
17464	12 x 13 mm	10	17472	24 x 27 mm	10
17465	14 x 15 mm	10	17486	21 x 23 mm	10
17466	13 x 16 mm	10	17480	28 x 30 mm	10
17467	13 x 17 mm	10	17473	30 x 32 mm	10
17482	14 x 17 mm	10	17485	36 x 41 mm	10
17468	16 x 17 mm	10			

KLÚČ OBOJSTRANNÝ OTVORENÝ

FESTA

CrV

DIN 3110



Č.p.	špecifikácia		Č.p.	špecifikácia	
17762	13 x 16 mm	10	17766	18 x 19 mm	10
17761	14 x 15 mm	10	17769	20 x 22 mm	10

KLÚČ OČKOPLOCHÝ

FESTA

CrV

DIN 3113



Č.p.	špecifikace		Č.p.	špecifikace	
17788	14 mm	10	17795	21 mm	10
17789	15 mm	10	17806	33 mm	10

KLÚČ UNIVERZÁLNY

Cr-Mo



12-13-14-15 mm

16-17-18-19 mm



Č.p.	špecifikácia	
17685	12-13-14-15-16-17-18-19 mm	1

KLÚČ NASTAVITELNÝ

FESTA

CrV



Č.p.	rozsah	dĺžka	
17197	0 - 29 mm	200 mm	1
17198	0 - 33 mm	250 mm	1
17199	0 - 38 mm	300 mm	1

KLÚČ NASTAVITELNÝ



Č.p.	rozsah	dĺžka	
17200	0 - 24 mm	200 mm	6
17201	0 - 30 mm	250 mm	6
17202	0 - 34 mm	300 mm	6

KLÚČ OBOJSTRANNÝ OTVORENÝ - SÚPRAVA

CrV

FESTA

DIN 3110



Č.p.	špecifikácia	
17506	6 ks · 6 x 7, 8 x 9, 10 x 11, 12 x 13, 14 x 15, 16 x 17	1
17508	8 ks · 6 x 7, 8 x 9, 10 x 11, 12 x 13, 14 x 15, 16 x 17, 18 x 19, 20 x 22	1

KLÚČ OČKOPLOCHÝ - SÚPRAVA

CrV

FESTA

DIN 3113



Č.p.	špecifikácia	
17526	6 ks · 10 x 10, 11 x 11, 13 x 13, 14 x 14, 16 x 16, 17 x 17	1
17528	8 ks · 8 x 8, 10 x 10, 11 x 11, 13 x 13, 14 x 14, 16 x 16, 17 x 17, 19 x 19	1

KLÚČ OČKOVÝ VYHNUTÝ - SÚPRAVA

CrV

FESTA

DIN 838

8x



Č.p.	špecifikácia	
17539	6 x 7, 8 x 9, 10 x 11, 12 x 13, 14 x 15, 16 x 17, 18 x 19, 20 x 22	1

KLÚČ OČKOPLOCHÝ - SÚPRAVA

CrV

FESTA

DIN 3113



Č.p.	špecifikácia	
17532	12 ks · 8 x 8, 9 x 9, 10 x 10, 11 x 11, 13 x 13, 14 x 14, 16 x 16, 17 x 17, 18 x 18, 19 x 19, 21 x 21, 22 x 22	10
17533	18 ks · 6 x 6, 7 x 7, 8 x 8, 9 x 9, 10 x 10, 11 x 11, 12 x 12, 13 x 13, 14 x 14, 15 x 15, 16 x 16, 17 x 17, 18 x 18, 19 x 19, 20 x 20, 21 x 21, 22 x 22, 24 x 24	1
17534	25 ks · 6 x 6, 7 x 7, 8 x 8, 9 x 9, 10 x 10, 11 x 11, 12 x 12, 13 x 13, 14 x 14, 15 x 15, 16 x 16, 17 x 17, 18 x 18, 19 x 19, 20 x 20, 21 x 21, 22 x 22, 23 x 23, 24 x 24, 25 x 25, 26 x 26, 27 x 27, 28 x 28, 30 x 30, 32 x 32	4

KLÚČ OBOJSTRANNÝ OTVORENÝ - SÚPRAVA

CrV

FESTA

DIN 3110

12x



Č.p.	špecifikácia	
17512	6 x 7, 8 x 9, 10 x 11, 12 x 13, 14 x 15, 16 x 17, 18 x 19, 20 x 22, 21 x 23, 24 x 27, 25 x 28, 30 x 32	1

KLÚČ OBOJSTRANNÝ OTVORENÝ - SÚPRAVA DIN 895

FESTA

DIN 895



Č.p.	špecifikácia	
17475	8 ks · 6 x 7, 8 x 9, 10 x 11, 12 x 13, 14 x 15, 16 x 17, 18 x 19, 20 x 22	5
17476	12 ks · 6 x 7, 8 x 9, 10 x 11, 12 x 13, 14 x 15, 16 x 17, 18 x 19, 20 x 22, 21 x 23, 24 x 27, 28 x 30, 30 x 32	3

KLÚČ RÁČŇOVÝ - SADA

FESTA

CrV

72T

7x



Č.p.	špecifikácia	
17620	8, 10, 12, 13, 14, 17, 19	5

KLÚČ RÁČŇOVÝ, KLBOVÝ - SADA

FESTA

NEW

CrV

72T

7x



Č.p.	špecifikácia	
17621	10, 12, 13, 14, 15, 17, 19	5

KLÚČ RÚRKOVÝ - SADA

FESTA

CrV

7x



Č.p.	špecifikácia	
17501	6 x 7, 8 x 9, 10 x 11, 12 x 13, 14 x 15, 16 x 17, 18 x 19	20
17640	páka na rúrkové kľúče · 135 mm	50

KLÚČ TRUBKOVÝ

FESTA

CrV



Č.p.	špecifikácia		Č.p.	špecifikácia	
17650	6 x 7 mm	10	17655	16 x 17 mm	10
17651	8 x 9 mm	10	17645	16 x 18 mm	10
17642	8 x 10 mm	10	17653	16 x 21 mm	10
17652	10 x 11 mm	10	17656	18 x 19 mm	10
17643	12 x 13 mm	10	17657	19 x 22 mm	10
17654	14 x 15 mm	10	17659	22 x 24 mm	10
17644	14 x 17 mm	10	17658	24 x 27 mm	10

KLÚČ HÁKOVÝ

FESTA

CrV



Č.p.	špecifikácia	
17680	19 - 51 mm 165 mm	5
17681	32 - 76 mm 216 mm	5
17682	51 - 121 mm 267 mm	5

RÝCHLOPÍNACIA MATICA PRE UHLOVÉ BRÚSKY

NEW

M14



Č.p.	špecifikácia	
20969		1

KLÚČ PRE UHLOVÉ BRÚSKY, NASTAVITEĽNÝ



Č.p.	špecifikácia	
20967	200 mm	15

KLÚČ NA UHLOVÉ BRÚSKY



Č.p.	špecifikácia	
20968	200 mm	1

KLÚČ MOMENTOVÝ

FESTA

Č.p.	špecifikácia	
17203	1/4" 5 - 25 Nm	1
17204	1/2" 19 - 110 Nm	1
17205	1/2" 42 - 210 Nm	1
17206	3/4" 140 - 700 Nm	1

RAČŇA LEŠENÁRSKA

FESTA

Č.p.	špecifikácia	
17451	18 mm	1
17450	19 mm	1

KLÚČ NA KOLESÁ



Č.p.	špecifikácia	
17600	17, 19, 22 mm, 13/16"	20

KLÚČ NA KOLESÁ



Č.p.	špecifikácia	
17601	17, 19, 21 mm	20

KLÚČ NA KOLESÁ SKLADACÍ



Č.p.	špecifikácia	
17602	17, 19, 21, 23 mm	5

KLÚČ TELESKOPICKÝ NA KOLESÁ



Č.p.	špecifikácia	
17603	17 x 19 mm, 21 x 23 mm	20

KLÚČ NÁSTRČNÝ KLBOVÝ



Č.p.	špecifikácia	
17261	16 mm	1
17262	21 mm	1

DRŽIAK MAGNETICKÝ

FESTA®



Č.p. špecifikace

70098

12

TELESKOP MAGNETICKÝ - LED

FESTA®

NEW

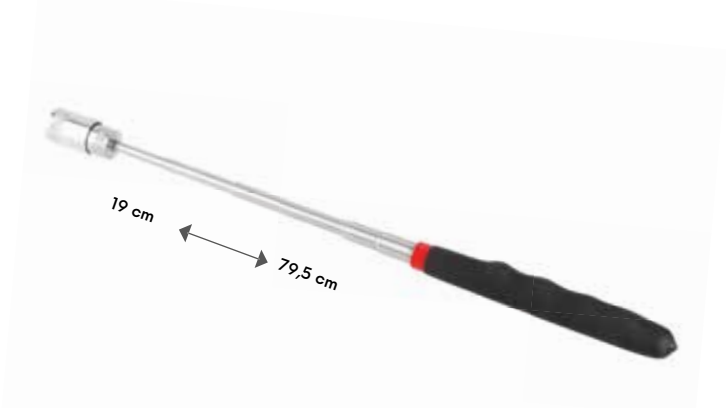

Č.p. špecifikace

13294

6

ZRKADLO INŠPEKČNÉ TELESKOPICKÉ

TELESKOP MAGNETICKÝ

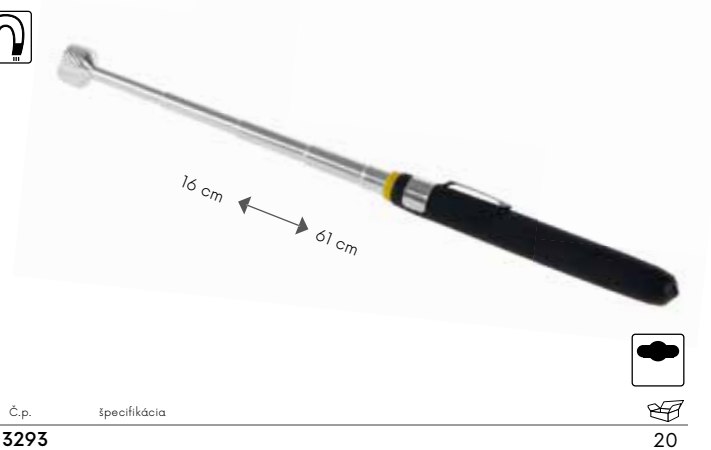
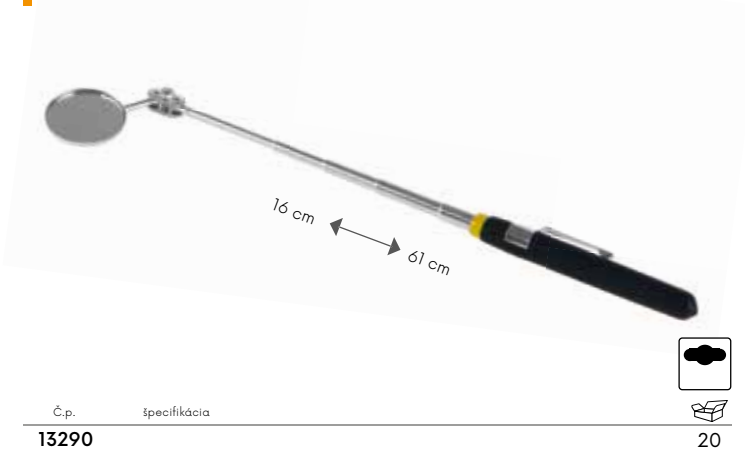

Č.p. špecifikácia

13290

20

Č.p. špecifikácia

13293

20

FESTA®

- Driek z kvalitnej S2 ocele
- Magnetické koncovky
- Ergonomická dvojkomponentná rukoväť s mäkkou TPE gumou



SKRUTKOVÁČ PLOCHÝ



Č.p.	špecifikácia	
18113	3 x 75 mm	12
18114	4 x 100 mm	12
18115	5,5 x 125 mm	12
18116	6,5 x 150 mm	12
18118	8 x 175 mm	6
18120	10 x 200 mm	6

SKRUTKOVÁČ PLOCHÝ KRÁTKY

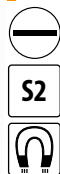

Č.p.	špecifikácia	
18124	5 x 38 mm	12
18125	6 x 38 mm	12

SKRUTKOVÁČ PHILIPS



Č.p.	špecifikácia	
18210	0 x 75 mm	12
18211	1 x 75 mm	12
18212	2 x 100 mm	12

SKRUTKOVÁČ PHILIPS KRÁTKY

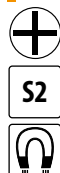

Č.p.	špecifikácia	
18215	1 x 38 mm	12
18216	2 x 38 mm	12

SKRUTKOVÁČ POZIDRIVE



Č.p.	špecifikácia	
18310	0 x 75 mm	12
18311	1 x 100 mm	12
18312	2 x 100 mm	12
18313	3 x 150 mm	6

SKRUTKOVÁČ POZIDRIVE KRÁTKY

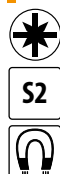

Č.p.	špecifikácia	
18321	1 x 38 mm	12
18322	2 x 38 mm	12

SKRUTKOVÁČ TORX

FESTA

S2

Č.p.	špecifikácia	
18350	T6	12
18351	T7	12
18352	T8	12
18353	T9	12
18354	T10	12
18355	T15	12



Č.p.	špecifikácia	
18356	T20	12
18357	T25	12
18358	T27	12
18359	T30	12
18360	T40	12

NÁSTRČNÝ SKRUTKOVÁČ

FESTA

CrV

Č.p.	špecifikácia	
18455	6 mm	12
18456	7 mm	12
18460	13 mm	12



SKRUTKOVÁČ ÚDEROVÝ PLOCHÝ

FESTA

CrV

Č.p.	špecifikácia	
18062	5,5 x 100 mm	12
18063	7 x 125 mm	6
18064	8 x 150 mm	8



Č.p.	špecifikácia	
18065	10 x 175 mm	6
18066	10 x 200 mm	6
18067	10 x 250 mm	6

VDE SKRUTKOVÁČ ELEKTRO PLOCHÝ

FESTA

1000 V
IEC/EN60900

Č.p.	špecifikácia		
18088	3 x 75 mm	S2	12
18089	4 x 100 mm	CrV	12
18090	5,5 x 125 mm	CrV	12
18091	6,5 x 150 mm	CrV	12
18092	8 x 175 mm	CrV	12



SKRUTKOVÁČ ÚDEROVÝ PHILIPS

FESTA

CrV

Č.p.	špecifikácia	
18070	PH 1 x 80 mm	16
18071	PH 2 x 100 mm	12
18072	PH 3 x 150 mm	6



Č.p.	špecifikácia	
18070	PH 1 x 80 mm	16
18071	PH 2 x 100 mm	12
18072	PH 3 x 150 mm	6

VDE SKRUTKOVÁČ ELEKTRO PHILIPS

FESTA

1000 V
IEC/EN60900

Č.p.	špecifikácia		
18080	PH 0 x 60 mm	S2	12
18081	PH 1 x 80 mm	CrV	12
18082	PH 2 x 100 mm	CrV	12
18083	PH 3 x 150 mm	CrV	12



SKRUTKOVÁČ ÚDEROVÝ POZIDRIVE

FESTA

CrV

Č.p.	špecifikácia	
18075	PZ 1 x 80 mm	12
18076	PZ 2 x 100 mm	12
18077	PZ 3 x 150 mm	6



Č.p.	špecifikácia	
18075	PZ 1 x 80 mm	12
18076	PZ 2 x 100 mm	12
18077	PZ 3 x 150 mm	6

VDE SKRUTKOVÁČ ELEKTRO POZIDRIVE

FESTA

1000 V
IEC/EN60900

Č.p.	špecifikácia		
18084	PZ 0 x 60 mm	S2	12
18085	PZ 1 x 80 mm	CrV	12
18086	PZ 2 x 100 mm	CrV	12
18087	PZ 3 x 150 mm	CrV	12



SADA SKRUTKOVÁČOV **FESTA**

S2

7x



S 3x75 · 5x100 · 6x175mm
 PH 0 · 1 · 2 · 3

Č.p. špecifikácia

18402 6

SADA SKRUTKOVÁČOV A BITOV **FESTA**

S2

27x



S 3 x 75 · 4x100 · 5,5x125 · 6,5 x 150mm
 PH 1 x 100 · 2 x 100mm
 adapter 1/4"

bity:

- S 4 · 5 · 6 · 7
- PH 1 · 2 · 3
- PZ 1 · 2 · 3
- T 10 · 15 · 20 · 25 · 30
- H 2 · 3 · 4 · 5 · 6

Č.p. špecifikácia

18422 27 ks 6

SADA SKRUTKOVÁČOV **FESTA**

S2

6x



S 3x75 · 5x100 · 6x150mm
 PH 0 · 1 · 2

Č.p. špecifikácia

18403 6

S 3 x 75 · 4x100 · 5,5x125 · 6,5 x 150mm
 PH 1 x 100 · 2 x 100mm
 adapter 1/4"

bity:

- S 4 · 5 · 6 · 7
- PH 1 · 2 · 3
- PZ 1 · 2 · 3
- T 10 · 15 · 20 · 25 · 30
- H 2 · 3 · 4 · 5 · 6

Č.p. špecifikácia

18422 27 ks 6

SADA SKRUTKOVÁČOV **FESTA**

S2

6x



S 3x60 · 6x100 · 6x125mm
 PZ 0 · 1 · 2

Č.p. špecifikácia

18404 6

SADA SKRUTKOVÁČOV **FESTA**

CrV

18x



S 6x38 · 5x75 · 6x100 · 8x150mm
 2,5x50 · S 3x50mm
 PH 2x38 · 1x75 · 2x100 · 3x150mm
 0x50 · 00x50mm
 T 5x50 · 6x50 · 7x50 · 8x50 · 9x50 · 10x50mm

Č.p. špecifikácia

18424 6

SADA SKRUTKOVÁČOV TORX **FESTA**

S2

5x



T 10 · 15 · 20 · 25 · 30

Č.p. špecifikácia

18340 6

SADA ÚDEROVÝCH SKRUTKOVÁČOV

FESTA

CrV

6x



⊖ S 5 · 6 · 8 mm

⊕ PH 1 · 2 · 3

Č.p. špecifikácia

18423



10

SADA ELEKTRO SKRUTKOVÁČOV

FESTA



6x



⚡ 1000 V ⚡
IEC/EN60900

⊖ S 4x100 · 5,5x125 mm · elektro skúšačka 0 - 250 V

⊕ PH 0x60 · 1x80 · 2x100 mm

Č.p. špecifikácia

18413



6

SKRUTKOVÁČ ÚDEROVÝ

FESTA

CrV

6x



⊖ S 7 x 35 · 8 x 35 · 8 x 70 mm

⊕ PH 2 x 35 · 3 x 35 · 3 x 70 mm

Č.p. špecifikácia

18411



1

SADA ELEKTRO SKRUTKOVÁČOV

FESTA



7x



⚡ 1000 V ⚡
IEC/EN60900:2004

⊖ S 4x100 · 5,5x125 · 6,5x150 mm · elektro skúšačka 0 - 250 V

⊕ PH 0x75 · 1x100 · 2x100 mm

Č.p. špecifikácia

18410



40

OTVÁRAČ

FESTA



Č.p. špecifikácia

18437



5

ELEKTRO SKÚŠAČKA

DIN VDE 0680
73/23 EEC



Č.p. špecifikácia
18426 0 - 250 V



1

SKRUTKOVÁČ PLOCHÝ



Č.p.	špecifikácia	
18101	3,5 x 75 mm	10
18102	4 x 100 mm	10
18103	5,5 x 100 mm	10
18104	5,5 x 125 mm	10
18105	6,5 x 100 mm	10
18106	6,5 x 125 mm	10
18107	8 x 160 mm	10
18108	10 x 160 mm	10

SADA SKRUTKOVÁČOV A BITOV



- S 3x75 · 4x75 · 6x100 · 8x150 mm
- PH 1x75 · 2x100 mm
- adapter 1/4"
- bity:
 - S 4 · 5 · 6 · 7 mm
 - PH 1 · 2 · 3
 - PZ 1 · 2 · 3
 - T 10 · 15 · 20

Č.p.	špecifikácia	
18418		10

SKRUTKOVÁČ PHILIPS



Č.p.	špecifikácia	
18201	0 x 75 mm	10
18202	1 x 75 mm	10
18203	2 x 100 mm	10
18204	3 x 150 mm	10

SADA SKRUTKOVÁČOV



Č.p.	špecifikácia	
18400	<ul style="list-style-type: none"> S 3x60 · 4x75 · 6x100 · 6x125 mm PH 0x60 · 1x75 · 2x100 mm 	10

SKRUTKOVÁČ POZIDRIVE



Č.p.	špecifikácia	
18301	0 x 75 mm	10
18302	1 x 75 mm	10
18303	2 x 100 mm	10
18304	3 x 150 mm	10

SADA SKRUTKOVÁČOV



Č.p.	špecifikácia	
18401	<ul style="list-style-type: none"> S 3x60 · 6x100 · 6x125 mm PH 1x75 · 2x100 mm 	50



T SKRUTKOVÁČ NA BITY S RAČŇOU

FESTRA

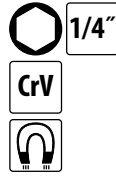

Č.p. 18608 špecifikácia



6

SKRUTKOVÁČ NA BITY

FESTRA



Č.p. 18110 špecifikácia



12

SKRUTKOVÁČ NA BITY S RAČŇOU

FESTRA

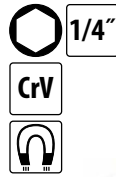

Č.p. 18433 špecifikácia



6

SKRUTKOVÁČ NA BITY + 7 BITOV

FESTRA

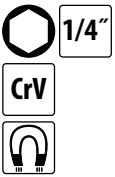

- ⊖ S 5 · 6 mm
- ⊕ PH 1 · 2 · 3
- ★ T 15 · 20

Č.p. 18425 špecifikácia



10

FLEXI SKRUTKOVÁČ NA BITY

FESTRA

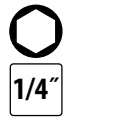

Č.p. 18451 špecifikácia



12

FLEXI SKRUTKOVÁČ NA HADICOVÉ SPONY

FESTRA



Č.p. 18450 špecifikácia



6

UHLOVÝ NADSTAVEC NA BITY 90°



Č.p. 18910 špecifikácia



25

RAČŇA NA BITY



Č.p. 18435 špecifikácia



1

SKRUTKOVÁČ RAČŇOVÝ S BITMI

FESTA

1/4" CrV 45x

1/4" → 1/4"

- ⊖ S 3 · 4 · 5 · 6 · 7 · 5 L
- ⊕ PH 1 · 2 · 3 · 1 L · 2 L
- ⊗ PZ 1 · 2 · 3 · 1 L · 2 L
- ⊙ H 2 · 2.5 · 3 · 4 · 5 · 6
- ⊛ T 10 · 15 · 20 · 25 · 27 · 30
- ⊚ SQ 0 · 1 · 2 · 3
- 1/4" 5 · 6 · 7 · 8 · 9 · 10 · 11 · 12 · 13 mm



6

Č.p. špecifikácia

18419

T SKRUTKOVÁČ + 20 NÁSTAVCOV

FESTA

1/4"



20x

- ⊖ S 3 · 4 · 5 · 6 · 8 mm
- ⊕ PH 0 · 1 · 2 · 3
- adapter + 5 · 6 · 7 · 8 · 9 · 10 · 11 · 12 · 13 mm



5

Č.p. špecifikácia

18420

SADA MINI SKRUTKOVÁČOV

FESTA

CrV



6x

- ⊖ S 1,5x50 · 2x50 · 2,5x50 mm
- ⊕ PH 000x50 · 00x50 · 0x50 mm



6

Č.p. špecifikácia

18416

SADA MINI SKRUTKOVÁČOV TORX

FESTA

CrV



7x

- ⊛ T 4 · 5 · 6 · 7 · 8 · 9 · 10x50 mm



6

Č.p. špecifikácia

18417

SKRUTKOVÁČ S MINI BITMI

FESTA

CrV

50x



- ⊖ S 1.5 · 2 · 2.5 · 3 · 3.5 mm
- ⊕ PH 000 · 00 · 0 · 1
- ⊗ PZ 0 · 1
- ⊛ T 5 · 6 · 7 · 8 · 9 · 10 · 15 · 20
- ⊙ H 0.9 · 1.3 · 2.0 · 2.5 · 3.0 · 4.0



6

Č.p. špecifikácia

18431

SADA MINI ELEKTRO SKRUTKOVÁČOV

FESTA

6x

- ⊖ S 2,4 · 3,0 mm
- ⊕ PH 0 · 1
- ⊛ T 6 · 8



10

Č.p. špecifikácia

18415

SKRUTKOVÁČE HODINÁRSKE



6x HOBBY

- ⊖ S 1,4 · 2,0 · 2,4 · 3,0 mm
- ⊕ PH 0 · 1



10

Č.p. špecifikácia

18408

SKRUTKOVÁČE HODINÁRSKE



11x HOBBY

- ⊖ S 1,0 · 1,2 · 1,4 · 1,8 · 2,4 · 3,0 mm
- ⊕ PH 00 · 0 · 1



48

Č.p. špecifikácia

18409

Stahlberg

bity - profesionálne skrutkovacie nástavce z vysoko legovanej ocele S2



VÝROBCA STAHLBERG

Značka svetového výrobcu skrutkovačích nástavcov s mnohoročnými skúsenosťami v odbore a so zákazníkmi po celom svete. Pri výrobe používa najnovšie technológie, najlepšie doteraz vyvinuté materiály a povrchové úpravy.



Technológia výroby

krížové a ploché skrutkovacie nástavce sú vyrábané špeciálnou technológiou presného kovania. Tá umožňuje dosiahnuť vysokej presnosti tvaru a súčasne zvýšenie pevnosti oproti obrábaným bitom až o 20%. Po kovaní sú bity kalené pre získanie optimálnej tvrdosti a húževnatosti.

TiN vrstva

vrstva nitrid titánu nanosená na povrch skrutkovacieho hrotu maximálne zvyšuje tvrdosť povrchu, oteruvzdornosť a trecie vlastnosti zabráňujúce vyšmyknutiu zo záberu.



Diamantové zrná

na povrchu hrotu sa doslova „zahryznú“ do hlavy vrtu či skrutky a udrží bit v zábere pre prenos maximálneho krútiaceho momentu. Sú najlepšou zárukou zotrvania v zábere. Najčastejšie sa skrutkovač bit totiž poškodí pri vyšmyknutí zo záberu. Krútiaci moment sa v tú chvíľu prenáša na minimálnu plochu, ktorá sa deformuje.









Protišmykové drážky

na pracovných plochách skrutkovačích hrotov vyrobených kovaním sú ďalšou veľmi účinnou obranou proti vyšmyknutiu hrotu zo záberu.











BIT PH DIAMANT 

    



Č.p.	špecifikácia	MOQ
18770	PH1 x 25 mm	5
18771	PH2 x 25 mm	5
18772	PH3 x 25 mm	5

BIT PZ DIAMANT 



Č.p.	špecifikácia	MOQ
18775	PZ1 x 25 mm	5
18776	PZ2 x 25 mm	5
18777	PZ3 x 25 mm	5

BIT PH 



Č.p.	špecifikácia	MOQ
18630	PH0 x 25 mm	5
18631	PH1 x 25 mm	5
18632	PH2 x 25 mm	5
18633	PH3 x 25 mm	5
18634	PH4 x 25 mm	5

BIT PZ 



Č.p.	špecifikácia	MOQ
18635	PZ0 x 25 mm	5
18636	PZ1 x 25 mm	5
18637	PZ2 x 25 mm	5
18638	PZ3 x 25 mm	5
18639	PZ4 x 25 mm	5

BIT PH 



Č.p.	špecifikácia	MOQ
18685	PH2 x 25 mm	5

BIT PZ 



Č.p.	špecifikácia	MOQ
18680	PZ2 x 25 mm	5

BIT PH 



Č.p.	špecifikácia	MOQ
18640	PH1 x 70 mm	10
18641	PH2 x 70 mm	10



BIT PZ 

   



Č.p.	špecifikácia	MOQ
18645	PZ1 x 70 mm	10
18646	PZ2 x 70 mm	10

BIT PH 



Č.p.	špecifikácia	MOQ
18760	PH0 x 25 mm	5
18761	PH1 x 25 mm	5
18762	PH2 x 25 mm	5
18763	PH3 x 25 mm	5
18764	PH4 x 25 mm	1





BIT PZ 

    



Č.p.	špecifikácia	MOQ
18765	PZ0 x 25 mm	5
18766	PZ1 x 25 mm	5
18767	PZ2 x 25 mm	5
18768	PZ3 x 25 mm	5
18769	PZ4 x 25 mm	5





BIT S 

   



Č.p.	špecifikácia	MOQ
18620	S 3 x 25 mm	5
18621	S 4 x 25 mm	5
18623	S 5 x 25 mm	5
18625	S 6 x 25 mm	5
18627	S 7 x 25 mm	5
18628	S 8 x 25 mm	5

BIT S 



Č.p.	špecifikácia	MOQ
18750	S 3 x 25 mm	5
18751	S 4 x 25 mm	5
18753	S 5 x 25 mm	5
18755	S 6 x 25 mm	5

BIT H



S2



Č.p.	špecifikácia	
18800	H 1,5 x 25 mm	5
18801	H 2,0 x 25 mm	5
18802	H 2,5 x 25 mm	5
18803	H 3,0 x 25 mm	5
18804	H 4,0 x 25 mm	5
18805	H 5,0 x 25 mm	5
18806	H 5,5 x 25 mm	5
18807	H 6,0 x 25 mm	5

BIT HTA



S2

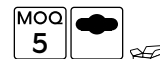

Č.p.	špecifikácia	
18810	HTα 1,5 x 25 mm	5
18811	HTα 2,0 x 25 mm	5
18812	HTα 2,5 x 25 mm	5
18813	HTα 3,0 x 25 mm	5
18814	HTα 4,0 x 25 mm	5
18815	HTα 5,0 x 25 mm	5
18816	HTα 5,5 x 25 mm	5
18817	HTα 6,0 x 25 mm	5

BIT T



S2



Č.p.	špecifikácia	
18820	T5 x 25 mm	5
18821	T6 x 25 mm	5
18822	T7 x 25 mm	5
18823	T8 x 25 mm	5
18824	T9 x 25 mm	5
18825	T10 x 25 mm	5
18826	T15 x 25 mm	5
18827	T20 x 25 mm	5
18828	T25 x 25 mm	5
18829	T27 x 25 mm	5
18830	T30 x 25 mm	5
18831	T40 x 25 mm	5
18832	T45 x 25 mm	5

BIT T



S2



Č.p.	špecifikácia		Č.p.	špecifikácia	
17980	T30 x 35 mm	3	17982	T45 x 35 mm	3
17981	T40 x 35 mm	3	17983	T50 x 35 mm	3

BIT TTA



S2



Č.p.	špecifikácia	
18835	TTα 5 x 25 mm	5
18836	TTα 6 x 25 mm	5
18837	TTα 7 x 25 mm	5
18838	TTα 8 x 25 mm	5
18839	TTα 9 x 25 mm	5
18840	TTα 10 x 25 mm	5
18841	TTα 15 x 25 mm	5
18842	TTα 20 x 25 mm	5
18843	TTα 25 x 25 mm	5
18844	TTα 27 x 25 mm	5
18845	TTα 30 x 25 mm	5
18846	TTα 40 x 25 mm	5
18847	TTα 45 x 25 mm	5

BIT T



S2



Č.p.	špecifikácia		Č.p.	špecifikácia	
17970	T20 x 75 mm	3	17974	T45 x 75 mm	3
17971	T25 x 75 mm	3	17975	T50 x 75 mm	3
			17976	T55 x 75 mm	3
			17972	T30 x 75 mm	3
			17973	T40 x 75 mm	3

BIT SD



S2



Č.p.	špecifikácia	
18855	SD 6 x 25 mm	5
18856	SD 8 x 25 mm	5

BIT TW



S2



Č.p.	špecifikácia	
18860	TW 1 x 25 mm	5
18861	TW 2 x 25 mm	5
18862	TW 3 x 25 mm	5
18863	TW 4 x 25 mm	5

BIT SQ



S2



Č.p.	špecifikácia	
18850	SQ 0 x 25 mm	5
18851	SQ 1 x 25 mm	5
18852	SQ 2 x 25 mm	5
18853	SQ 3 x 25 mm	5

BIT



S2



Č.p.	špecifikácia	
18866	5/32 x 25 mm	5
18867	3/16 x 25 mm	5

BIT TS



S2



Č.p.	špecifikácia	
18864	TS 4 x 25 mm	5
18865	TS 6 x 25 mm	5



BIT XZN

Č.p.	špecifikácia	5
18870	M4 x 25 mm	5
18871	M5 x 25 mm	5
18872	M6 x 25 mm	5
18873	M8 x 25 mm	5
18874	M10 x 25 mm	5

BIT NA SADROKARTÓN

Č.p.	špecifikácia	24
18795	PH 2 x 25 mm	24
18796	PH 2 x 55 mm	24

BIT ADAPTÉR

1/4" ↔ 1/4"

Č.p.	špecifikácia	5
18868	25 mm	5
18869	50 mm	5

ADAPTÉR RAČŇA 1/4" - BIT

1/4" ↔ 1/4"

Č.p.	špecifikácia	5
18619		5

NADSTAVEC NA BITY

Č.p.	špecifikácia	5
18600	1/4' x 60 mm	5

NADSTAVEC NA BITY

Č.p.	špecifikácia	1
18797	1/4' x 60 mm	1

NADSTAVEC NA BITY

· rýchlopínací

Č.p.	špecifikácia	5
18601	1/4' x 60 mm	5

NADSTAVEC NA BITY

· rýchlopínací

Č.p.	špecifikácia	1
18798	1/4' x 60 mm	1

NADSTAVEC NA BITY

· s dorazom

Č.p.	špecifikácia	5
18602	1/4' x 60 mm	5

NADSTAVEC NA BITY

· s dorazom

Č.p.	špecifikácia	1
18799	1/4' x 60 mm	1

NADSTAVEC NA BITY, ODPRUŽENÝ

Č.p.	špecifikácia	1
18609	1/4' x 70 mm	1

NADSTAVEC NA BITY

Č.p.	špecifikácia	25
18607	80 mm	25

ADAPTÉR 1/4"

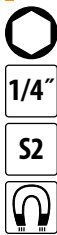

Č.p.	špecifikácia		Č.p.	špecifikácia	
18610	6 mm	5	18613	10 mm	5
18611	7 mm	5	18614	12 mm	5
18612	8 mm	5	18615	13 mm	5

ADAPTÉR - SADA



Č.p.	špecifikácia	
18618	6, 7, 8, 9, 10, 11, 12, 13 mm	10

SADA BITOV A ADAPTÉROV

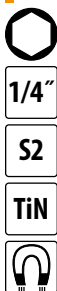

- 10x ⊕ 18630 PH0
- 10x ⊕ 18631 PH1
- 10x ⊕ 18632 PH2
- 10x ⊕ 18633 PH3
- 10x ⊕ 18635 PZ0
- 10x ⊕ 18636 PZ1
- 10x ⊕ 18637 PZ2
- 10x ⊕ 18638 PZ3
- 10x ⊕ 18761 PH1 TiN
- 10x ⊕ 18762 PH2 TiN
- 10x ⊕ 18763 PH3 TiN
- 10x ⊕ 18766 PZ1 TiN
- 10x ⊕ 18767 PZ2 TiN
- 10x ⊕ 18768 PZ3 TiN
- 10x ⊕ 18770 PH1 DIAMANT
- 10x ⊕ 18771 PH2 DIAMANT
- 10x ⊕ 18775 PZ1 DIAMANT
- 10x ⊕ 18776 PZ2 DIAMANT
- 10x ⊙ 18814 4,0HTa
- 10x ⊙ 18815 5,0HTa
- 10x ⊙ 18842 20TTa
- 10x ⊙ 18845 30TTa
- 10x ⊕ 18795 PH2 na sadrokartón
- 5x 18612 adaptér 1/4" 8mm
- 5x 18613 adaptér 1/4" 10mm
- 5x 18600 magnetický nadstavec 1/4" 60mm
- 5x 18601 magnetický nadstavec, rychloupínací 1/4" 60mm
- 5x 18602 magnetický nadstavec, s dorazom 1/4" 65mm

Č.p.	špecifikácia
18993	



SADA BITOV

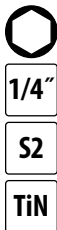

- 10x ⊕ 18631 PH1
- 10x ⊕ 18632 PH2
- 10x ⊕ 18633 PH3
- 10x ⊕ 18636 PZ1
- 10x ⊕ 18637 PZ2
- 10x ⊕ 18638 PZ3
- 10x ⊕ 18761 PH1 TiN
- 10x ⊕ 18762 PH2 TiN
- 10x ⊕ 18763 PH3 TiN
- 10x ⊕ 18766 PZ1 TiN
- 10x ⊕ 18767 PZ2 TiN
- 10x ⊕ 18768 PZ3 TiN
- 10x ⊙ 18804 H 4
- 10x ⊙ 18805 H 5
- 10x ⊙ 18825 T 10
- 10x ⊙ 18826 T 15
- 10x ⊙ 18827 T 20
- 10x ⊙ 18828 T 25
- 10x ⊙ 18830 T 30
- 10x ⊙ 18831 T 40

Č.p.	špecifikácia
18994	



SADA BITOV

FESTA



1/4"

S2



32x

· magnetický nadstavec
rýchlopínací



- ⊖ S 3 · 4 · 5 · 6
- ⊕ PH 1 · 2 · 3
- ⊛ PZ 1 · 2 · 3
- H 3 · 4 · 5 · 6
- ⊛ T 10 · 15 · 20 · 25 · 27 · 30 · 40
- ⊛ TTa 10 · 15 · 20 · 25 · 27 · 30 · 40

Č.p. špecifikácia

18905



5

SADA BITOV

FESTA



1/4"

S2



57x

· magnetický nadstavec
rýchlopínací



- ⊖ S 4 · 5 · 6
- ⊕ PH 1 · 2 · 3
- ⊛ PZ 1 · 2 · 3
- H 3 · 4 · 5 · 6
- ⊛ T 10 · 15 · 20 · 25 · 27 · 30 · 40
- ⊛ TTa 10 · 15 · 20 · 25 · 27 · 30 · 40

Č.p. špecifikácia

18906



5

SADA BITOV

FESTA



1/4"

S2

33x



- ⊙ HTa 2 · 2.5 · 3 · 4 · 5 · 6
5/32" · 9/64" · 1/8"
7/64" · 3/32" · 5/64"

⊙ SD 4 · 6 · 8 · 10

⊕ TS 6 · 8 · 10

⊕ TW 1 · 2 · 3 · 4

⊛ TTa 8 · 10 · 15 · 20 · 25 · 27 · 30 · 35 · 40
magnetický nadstavec

Č.p. špecifikácia

18900



10

SADA BITOV

FESTA



1/4"

S2

33x



⊖ S 3 · 4 · 5 · 6 · 7

⊕ PH 0 · 1 · 2 · 3

⊛ PZ 1 · 2 · 3

● H 2 · 2.5 · 3 · 4 · 5 · 6

⊛ T 10 · 15 · 20 · 25 · 30 · 40
magnetický nadstavec

Č.p. špecifikácia

18901



10

SADA BITOV

FESTA



1/4"

S2



100x



- ⊖ S 3 · 4 · 4.5 · 5 · 5.5 · 6 · 6.5 · 7 · 8
 - ⊕ PH 0 · 1 · 2 · 3
 - ⊛ PZ 0 · 1 · 2 · 3
 - ⊛ SQ 0 · 1 · 2 · 3
 - ⊛ T 8 · 10 · 15 · 20 · 25 · 27 · 30 · 40 · 45
 - ⊛ TTa 8 · 10 · 15 · 20 · 25 · 27 · 30 · 35 · 40
 - H 1.5 · 2 · 2.5 · 3 · 4 · 5 · 5.5 · 6 · 8 mm
1/16" · 5/64" · 3/32" · 7/64" · 1/8" · 9/64"
5/32" · 3/16" · 7/32" · 1/4"
 - ⊙ HTa 2 · 2.5 · 3 · 4 · 5 · 6 mm
5/64" · 3/32" · 7/64" · 1/8" · 9/64" · 5/32"
 - ⊙ SD 4 · 6 · 8 · 10
 - ⊕ TS 6 · 8 · 10
 - ⊕ TW 1 · 2 · 3 · 4
 - ⊕ 2-wing 1 · 2 · 3
 - XZN 5 · 6 · 8
- magnetický nadstavec
nadstavec „Y“
1/4" DR nadstavec na skrutkovač
1/4" bit adaptér: 25mm, 50mm

Č.p. špecifikácia

18909



10

SADA BITOV

S2

20x

- ⊖ S 4 · 5 · 6 · 7
- ⊕ PH 1 · 2 · 3
- ⊛ PZ 1 · 2 · 3
- H 4 · 5 · 6
- ⊛ T 10 · 15 · 20 · 25
- SQ 1 · 2 · 3



10

Č.p. špecifikácia
18907

SADA BITOV

CrV

TiN

10x

- ⊖ S 4 · 5 · 6 · 7
- ⊕ PH 1 · 2 · 3
- ⊛ PZ 1 · 2 · 3

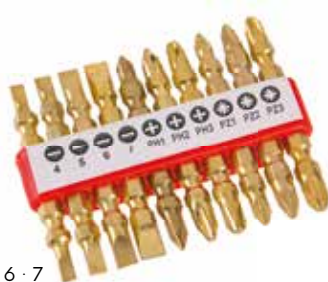

10

Č.p. špecifikácia
18440

SADA BITOV



HOBBY

7x

- ⊖ S 3 · 5 · 7
- ⊕ PH 1 · 2 · 3

magnetický nastavec na bity



20

Č.p. špecifikácia
18430



SADA BITOV A NÁSTAVCOV

1/4"

CrV



41x

- ⊖ S 3 · 4 · 4,5 · 5 · 5,5 · 6 · 7
- ⊕ PH 1 · 2 · 3
- ⊛ PZ 1 · 2 · 3
- H 2 · 3 · 4 · 5
- ⊛ T 20 · 30
- 1/4" 4 · 4,5 · 5 · 5,5 · 6 · 7 · 8 · 9 · 10
- 5/32" · 3/16" · 7/32" · 1/4" · 9/32" · 5/16" · 11/32" · 3/8" · 7/16"

magnetický skrutkovač
nastavec na bity
2 ks adaptér



10

Č.p. špecifikácia
18916

SADA BITOV A NÁSTAVCOV

CrV

1/4"



40x

- ⊖ S 3 · 3,5 · 4 · 5,5
- ⊕ PH 0 · 1 · 2 · 3
- ⊛ PZ 0 · 1 · 2 · 3
- H 3 · 4
- ⊛ T 10 · 15 · 20 · 25 · 27 · 30
- 1/4" 4 · 4,5 · 5 · 5,5 · 6 · 7 · 8 · 9 · 10 · 11 · 13

nastavec na skrutkovač 1/4"
magnetický nastavec na bity



10

Č.p. špecifikácia
18915



SADA NÁRADIA

1/4"

CrV

23x

Č.p. špecifikácia
18421



- ⊖ S 5 · 6 mm
- ⊕ PH 1 · 2
- H 3 · 4 · 5 · 6
- ⊛ T 15 · 20 · 25 · 30
- 1/4" 4 · 5 · 6 · 7 · 8 · 9 · 10 · 12 · 13 mm
- 75 mm 1/4"
- 1/4" → 1/4"



1

SADA NÁRADIA

35x

Č.p. špecifikácia
17260



- 120mm
- 125mm
- 115mm
- 150mm max. 19mm
- 9mm
- 1/4" 160mm
- 5 · 6 · 7 · 8 · 9 · 10 · 11 mm
- 1/4"
- 1/4"
- ⊖ S 4 · 6 mm
- ⊕ PH 1 · 2 · 3
- ⊛ PZ 1 · 2
- H 4 · 5 · 6



1

SADA NÁRADIA

NEW

CrV

S2

1/4"

1/2"

72T

122x



- 1/2", 1/4"
- 1/4" · 4-5-6-7-8-9mm
- 1/2" · 10-12-13-14-17-19mm
- 1/4" · 4-4.5-5-5.5-6-7-8-9-10-11-12-13-14mm
- 1/2" · 12-13-14-15-16-17-18-19-20-21-22-24mm
- 1/2", 1/4"
- 1/4" · 1/4"
- 1/4" · 150mm
- 1/2" · 254mm
- 1/2", 1/4"
- 1/2" · 16-21mm
- 1/4" · 150mm
- 1/2" · E10-E12-E14-E16-E18-E20-E22-E24
- 1/4" · S 3 · 4 · 5 · 6
- 1/4" · PH 0 · 1 · 2
- 1/4" · PZ 0 · 1 · 2
- 1/4" · S 4 · 5.5 · 6.5
- 1/4" · PH 1 · 2 · 3
- 1/4" · PZ 2 · 3
- 1/4" · H 3 · 4 · 5 · 6
- 1/4" · T 8 · 10 · 15 · 20 · 25
- 1/4" · TTA 10 · 15 · 20 · 25 · 40
- 2 · 2.5 · 3 · 4 · 5 · 6 · 7 · 8 · 10mm
- 8-9-10-11-12-13-14-15-16-17-18-19mm
- S 4x100 · 6,5x150
- PH 2x100 · 3x150
- 180mm
- 160mm
- 160mm
- 250mm
- 300g

Č.p. špecifikácia

17238



1

SADA NÁRADIA

60x



- 160 mm
- 160 mm
- 300 g
- 1/4" 45T
- 4 · 5 · 6 · 7 · 8 · 9 · 10 · 11 · 12 · 13 mm
- 1/4" 75 mm
- 1,5 · 2 · 2,5 · 3 · 4 · 5 · 6 · 8 · 10 mm
- S 3 · 4 · 5 · 6 mm
- PH 0 · 1 · 2 · 3
- PZ 0 · 1 · 2 · 3
- T 10 · 15 · 20 · 25
- H 3 · 4 · 5 · 6
- S 5x100 mm
- PH 1x100 · 2x100 mm
- S 2,5x50 mm
- PH 00x50 · 0x50 mm
- AC 100-250 V
- 200 mm max. 22 mm
- 10x11 · 12x13 · 14x15 · 16x17 mm
- 18 mm
- 2 m | 13 mm

Č.p. špecifikácia

17259



1

SADA NÁRADIA

32x



- 1/4" 5 · 6 · 7 · 8 · 9 · 10 · 11 · 12 mm
- 1/4"
- 1/4"
- AC 230 V
- PH 0, SL 3
- 9x 1,5-10 mm
- 160 mm
- S 3 · 4 · 5 · 6 mm
- PH 0 · 1 · 2 · 3
- H 4 · 5
- PH 2x100, S 6x100
- 18 mm
- 1 m
- 300 g

Č.p. špecifikácia

17247



1

SADA INBUS



CrV

9x

- H 1,5 mm
- H 2 mm
- H 2,5 mm
- H 3 mm
- H 4 mm
- H 5 mm
- H 6 mm
- H 8 mm
- H 10 mm



10

Č.p. špecifikácia

18496

SADA INBUSOV S HLAVIČKOU



CrV

9x

- H 1,5 mm
- H 2 mm
- H 2,5 mm
- H 3 mm
- H 4 mm
- H 5 mm
- H 6 mm
- H 8 mm
- H 10 mm



10

Č.p. špecifikácia

18500

SADA INBUS - PREDĹŽENÉ



CrV

9x

- H 1,5 mm
- H 2 mm
- H 2,5 mm
- H 3 mm
- H 4 mm
- H 5 mm
- H 6 mm
- H 8 mm
- H 10 mm



10

Č.p. špecifikácia

18490

SADA INBUSŮ S HLAVIČKOU



CrV

9x

- H 1,5 mm
- H 2 mm
- H 2,5 mm
- H 3 mm
- H 4 mm
- H 5 mm
- H 6 mm
- H 8 mm
- H 10 mm



10

Č.p. špecifikácia

18498

SADA INBUS S HLAVIČKOU



CrV

9x

- 1/16"
- 5/64"
- 3/32"
- 1/8"
- 5/32"
- 3/16"
- 1/4"
- 5/16"
- 3/8"



10

Č.p. špecifikácia

18493

SADA KLÚČOV TORX



CrV

9x

- T 10 mm
- T 15 mm
- T 20 mm
- T 25 mm
- T 27 mm
- T 30 mm
- T 40 mm
- T 45 mm
- T 50 mm



10

Č.p. špecifikácia

18497

SADA INBUS S HLAVIČKOU - PREDĹŽENÉ



CrV

9x

- H 1,5 mm
- H 2 mm
- H 2,5 mm
- H 3 mm
- H 4 mm
- H 5 mm
- H 6 mm
- H 8 mm
- H 10 mm



10

Č.p. špecifikácia

18492

SADA KLÚČOV TORX - PREDĹŽENÉ



CrV

9x

- T 10 mm
- T 15 mm
- T 20 mm
- T 25 mm
- T 27 mm
- T 30 mm
- T 40 mm
- T 45 mm
- T 50 mm



10

Č.p. špecifikácia

18491

KLÚČ INBUS - STANDARD

FESTA

DIN 911



CrV



Č.p.	špecifikácia		
18540	1,5 mm	14 x 45 mm	1
18541	2 mm	16 x 50 mm	1
18542	2,5 mm	18 x 56 mm	1
18543	3 mm	20 x 63 mm	1
18544	4 mm	25 x 70 mm	1
18545	5 mm	28 x 80 mm	1
18546	6 mm	32 x 90 mm	1
18547	7 mm	34 x 95 mm	1
18548	8 mm	36 x 100 mm	1
18549	9 mm	38 x 105 mm	1
18550	10 mm	40 x 112 mm	1
18551	11 mm	42 x 120 mm	1
18552	12 mm	45 x 125 mm	1
18553	13 mm	50 x 130 mm	1
18554	14 mm	56 x 140 mm	1
18557	17 mm	63 x 160 mm	1
18559	19 mm	70 x 180 mm	1
18562	22 mm	80 x 200 mm	1
18567	27 mm	100 x 250 mm	1
18572	32 mm	125 x 315 mm	1

KLÚČ INBUS S HLAVIČKOU - PREDĹŽENÝ

FESTA



CrV



Č.p.	špecifikácia		
18575	1,5 mm	15 x 75 mm	1
18576	2 mm	17 x 81 mm	1
18577	2,5 mm	18 x 87 mm	1
18578	3 mm	20 x 96 mm	1
18579	4 mm	24 x 107 mm	1
18580	5 mm	30 x 120 mm	1
18581	6 mm	33 x 136 mm	1
18582	7 mm	34 x 144 mm	1
18583	8 mm	36 x 153 mm	1
18584	9 mm	38 x 155 mm	1
18585	10 mm	40 x 171 mm	1
18586	11 mm	40 x 230 mm	1
18587	12 mm	42 x 250 mm	1
18588	13 mm	45 x 260 mm	1
18589	14 mm	56 x 280 mm	1
18593	17 mm	61 x 290 mm	1

KLÚČ TORX

FESTA



CrV



Č.p.	špecifikácia	
18466	T7	1
18468	T9	1
18476	T45	1
18477	T50	1

KLÚČ INBUS - PREDĹŽENÝ

FESTA



CrV



Č.p.	špecifikácia		
18510	1,5 mm	15 x 75 mm	1
18511	2 mm	17 x 81 mm	1
18512	2,5 mm	18 x 87 mm	1
18513	3 mm	20 x 96 mm	1
18514	4 mm	24 x 107 mm	1
18515	5 mm	30 x 120 mm	1
18516	6 mm	33 x 136 mm	1
18518	8 mm	36 x 153 mm	1
18519	9 mm	38 x 155 mm	1
18520	10 mm	40 x 171 mm	1
18521	11 mm	40 x 230 mm	1
18522	12 mm	42 x 250 mm	1
18523	13 mm	45 x 260 mm	1
18524	14 mm	56 x 280 mm	1
18527	17 mm	61 x 290 mm	1

SADA INBUS

FESTA



CrV



Č.p.	špecifikácia	
18508	1,5 · 2 · 2,5 · 3 · 4 · 5 · 6 mm	1

NÁSTRČNÝ T - KLÚČ INBUS SADA

FESTA



CrV

9x



2 mm
2,5 mm
3 mm
4 mm
5 mm
6 mm
7 mm
8 mm
10 mm



Č.p. špecifikácia

18494

6

NÁSTRČNÝ T - KLÚČ TORX SADA

FESTA



CrV

9x



T 10
T 15
T 20
T 25
T 27
T 30
T 40
T 45
T 50



Č.p. špecifikácia

18495

6

SADA INBUS



8x

HOBBY



Č.p. špecifikácia

18499 2 · 2,5 · 3 · 4 · 5 · 6 · 8 · 10 mm



1

KLÚČ NÁSTRČNÝ T - TORX

FESTA



CrV



Č.p.	špecifikácia	
17350	T 7	10
17351	T 8	10
17352	T 9	10
17353	T 10	10

Č.p.	špecifikácia	
17357	T 27	10
17359	T 40	10
17360	T 45	10
17361	T 50	10

FESTA

KLADIVÁ A ŠŪĽKY



KLADIVO

FESTA

DIN
1041



jaseňová násada

Č.p.	špecifikácia	
19081	100 g	1
19082	200 g	1
19083	300 g	1
19084	400 g	1
19085	500 g	1

Č.p.	špecifikácia	
19086	600 g	1
19088	800 g	1
19090	1000 g	1
19092	1500 g	1
19095	2000 g	1

ŠŪĽKA

FESTA

DIN
1041



jaseňová násada

Č.p.	špecifikácia		Č.p.	špecifikácia	
19096	3000 g	1	19106	6000 g	1
19097	4000 g	1	19108	8000 g	1
19098	5000 g	1	19109	10000 g	1

ŠŪĽKA

FESTA

DIN
6475



jaseňová násada

Č.p.	špecifikácia	
19074	5000 g	1
19075	6000 g	1
19076	8000 g	1
19077	10000 g	1

KLADIVO FIBERGLASS

FESTA



· násada fiberglass

Č.p.	špecifikácia		Č.p.	špecifikácia	
19021	100 g	12	19026	600 g	6
19022	200 g	12	19028	800 g	6
19023	300 g	12	19030	1000 g	6
19024	400 g	12	19031	1500 g	6
19025	500 g	12	19032	2000 g	1

ŠŪĽKA FIBERGLASS

FESTA

DIN 6475



· násada fiberglass

Č.p.	špecifikácia		Č.p.	špecifikácia	
19066	1000 g	4	19070	3000 g	4
19067	1250 g	4	19071	4000 g	4
19068	1500 g	4	19058	5000 g	4
19069	2000 g	2	19059	6000 g	2

KLADIVO

DIN 1041



· kruhový klin

Č.p.	špecifikácia		Č.p.	špecifikácia	
19001	100 g	12	19006	600 g	6
19002	200 g	12	19008	800 g	6
19003	300 g	6	19010	1000 g	6
19004	400 g	6	19015	1500 g	6
19005	500 g	6	19020	2000 g	6

ŠŪĽKA

DIN 6475



· kruhový klin

Č.p.	špecifikácia		Č.p.	špecifikácia	
19053	1000 g	6	19055	2000 g	6
19050	1250 g	6	19056	3000 g	6
19054	1500 g	6	19057	4000 g	6

ŠŪĽKA FIBERGLASS

FESTA



· násada fiberglass

Č.p.	špecifikácia	
19034	3000 g	4
19036	4000 g	4

KLADIVO OBUVNÍČKE FIBERGLASS

FESTA



· násada fiberglass

Č.p.	špecifikácia	
19064	450 g	6

KLADIVO TESÁRSKE FIBERGLASS

FESTA



· násada fiberglass

Č.p.	špecifikácia	
19061	600 g	6

KLADIVO MURÁRSKE FIBERGLASS

FESTA



· násada fiberglass

Č.p.	špecifikácia	
19151	600 g	6

KLADIVO OBUVNÍČKE MONOLIT

FESTA



Č.p.	špecifikácia	
19063	450 g	6

KLADIVO TESÁRSKE MONOLIT

FESTA



Č.p.	špecifikácia	
19062	600 g	6

KLADIVO MURÁRSKE MONOLIT

FESTA



Č.p.	špecifikácia	
19150	600 g	6

KLADIVO TESÁRSKE



Č.p.	špecifikácia	
19100	600 g	6

KLADIVO OBUVNÍČKE

FESTA



Č.p.	špecifikácia	
19065	600 g	6

KLADIVO TESÁRSKE

FESTA



Č.p.	špecifikácia	
19060	600 g	6

ŠŮLKA

FESTA



Č.p.	špecifikácia	
19051	1000 g	6
19052	1500 g	6

KLADIVO - SEKERA

FESTA



Č.p.	špecifikácia	
19303	600 g	6

KLADIVO MURÁRSKE



jaseňová násada

Č.p.	špecifikácia	
19149	44 mm	1

KLADIVO MURÁRSKE



jaseňová násada

Č.p.	špecifikácia	
19124	24 mm	1
19136	36 mm	1
19148	48 mm	1

KLADIVO ZVÁRAČSKÉ



Č.p.	špecifikácia	
19115	300 g	1

NÁSADA NA KLADIVO JASEŇOVÁ



Č.p.	špecifikácia	
61240	násada	1

NÁSADA NA KLADIVO JASEŇOVÁ



Č.p.	špecifikácia	pre	
61320	26 cm	19081	10
61321	28 cm	19082	10
61322	30 cm	19083	10
61323	31 cm	19084	10
61324	32 cm	19085	10

Č.p.	špecifikácia	pre	
61325	33 cm	19086	10
61326	35 cm	19088	10
61327	36 cm	19090	10
61328	38 cm	19092	10
61329	40 cm	19095	10

NÁSADA ŠŪLKY JASEŇOVÁ



Č.p.	špecifikácia	pre	
61330	80 cm	19074, 19075	10
61331	90 cm	19076, 19077	10

KLIN KRUHOVÝ KÓNICKÝ



Č.p.	špecifikácia	
19430	6 mm	10
19431	8 mm	10
19432	10 mm	10
19433	12 mm	10
19434	14 mm	10
19435	16 mm	10

KLIN KOVANÝ



Č.p.	špecifikácia	
19440	úzký	10
19441	střední	10
19442	široký	10
19443	široký S	10

KLIN



3x



Č.p.	špecifikácia	
19398	20 x 25 x 5	1
19399	30 x 40 x 5	1

ŠŮLKA DREVENÁ

FESTA



· bukové dřevo

Č.p.	špecifikácia		
19202	Ø 60 x 120 mm	350 g	1

ŠŮLKA DREVENÁ

FESTA



· bukové dřevo

Č.p.	špecifikácia		
19200	80 x 60 mm	520 g	1

ŠŮLKA GUMOVÁ

FESTA

· jaseňová násada



Č.p.	špecifikácia		
19245	Ø 55 mm	400 g	1
19246	Ø 60 mm	800 g	1
19247	Ø 70 mm	1000 g	1
19248	Ø 95 mm	2000 g	1
19249	Ø 115 mm	3000 g	1

ŠŮLKA GUMOVÁ

FESTA



· násada fiberglass



Č.p.	špecifikácia		
19270	Ø 55 mm		6
19271	Ø 65 mm		6
19272	Ø 90 mm		6

ŠŮLKA GUMOVÁ

FESTA



Č.p.	špecifikácia		
19255	Ø 55 mm		6
19265	Ø 65 mm		6
19290	Ø 90 mm		6

ŠŮLKA GUMOVÁ BIELA

FESTA



Č.p.	špecifikácia		
19294	Ø 65 mm		6
19295	Ø 90 mm		6

ŠŮLKA GUMOVÁ ČIERNO-BIELA



Č.p.	špecifikácia		
19254	Ø 65 mm		6

ŠŮLKA GUMOVÁ



Č.p.	špecifikácia	
19251	Ø 55 mm 400 g	12
19252	Ø 65 mm 700 g	6
19253	Ø 90 mm 1300 g	4

ŠŮLKA SILIKÓNOVÁ



Č.p.	špecifikácia	
19297	Ø 35 mm	12

ŠŮLKA MOSADZNÁ



· násada fiberglass

Č.p.	špecifikácia	
19211	Ø 30 mm 500 g	1

ŠŮLKA NYLONOVÁ



· násada fiberglass

Č.p.	špecifikácia	
19209	Ø 34 mm	6

PALIČKA S VÝMENNÝMI KONCAMI



NEW



TPU - 95 Shore A ·		PP - 97 Shore A
TPE - 90 Shore A ·		TPE - 90 Shore A
TPU - 92 Shore A ·		TPU - 92 Shore A
TPE - 90 Shore A ·		TPU - 88 Shore A

Č.p.	špecifikácia	
19208	Ø 40 mm	1

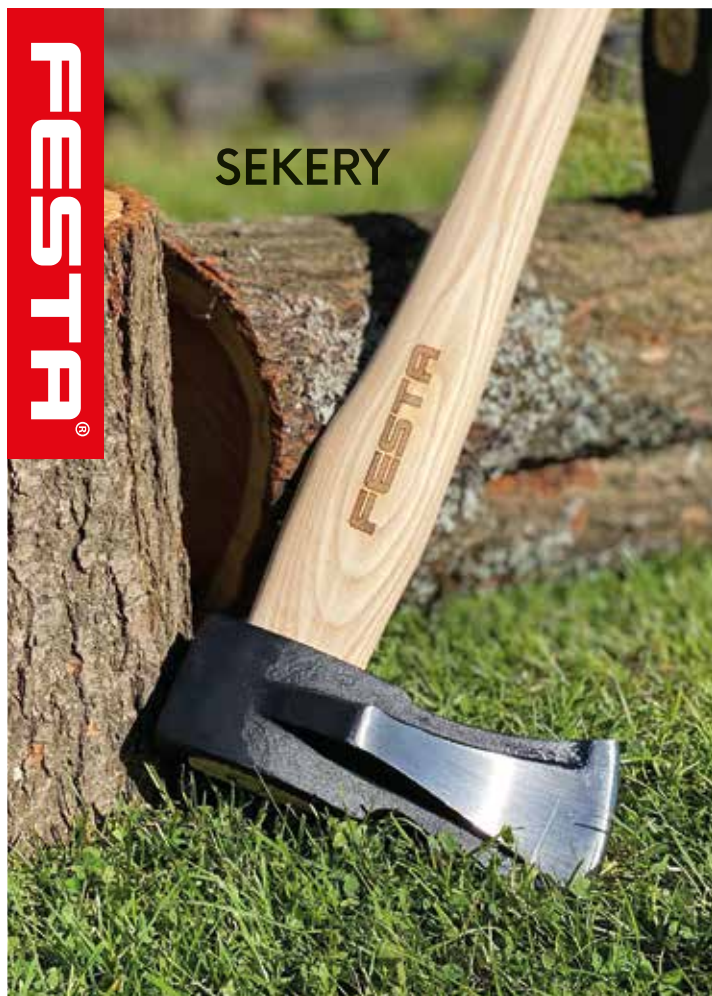

SEKERY

FESTA

SEKERA

FESTA

DIN 5131

DIN 7294



- jaseňová násada
- kruhový klin

Č.p.	špecifikácia		Č.p.	špecifikácia	
19380	600 g	1	19384	1400 g	1
19381	800 g	1	19385	1600 g	1
19382	1000 g	1	19387	2000 g	1
19383	1250 g	1			

SEKERA TESÁRSKA

FESTA



- jaseňová násada

Č.p.	špecifikácia	
19340	700 g	22

KALAČ

FESTA

DIN 5129



- jaseňová násada
- kruhový klin

Č.p.	špecifikácia	
19389	3000 g	1
19388	4000 g	1

SEKERA ŠTIEPACIA

FESTA

DIN 7294



- jaseňová násada
- kruhový klin

Č.p.	špecifikácia	
19391	2000 g	1

SEKERA

NÁSADA NA SEKERU JASEŇOVÁ



Č.p.	špecifikácia	
19306	600 g	24
19308	800 g	24
19310	1000 g	24
19312	1250 g	12
19314	1500 g	12

Č.p.	špecifikácia	pre	
61340	36 cm	19380	10
61341	40 cm	19381, 19340	10
61342	50 cm	19382	10
61343	70 cm	19383, 19384	10

Č.p.	špecifikácia	pre	
61344	80 cm	19385, 19391	10
61345	90 cm	19387	10
61346	90 cm	19388, 19389	10

SEKERA FIBERGLASS



SEKERA CAMP FIBERGLASS



· násada fiberglass

Č.p.	špecifikácia	
19326	600 g	6
19328	800 g	24
19330	1000 g	12

Č.p.	špecifikácia	
19332	1250 g	8
19335	1600 g	6
19337	2000 g	6

· násada fiberglass

Č.p.	špecifikácia	
19301	500 g	6

SEKERA ŠTIEPACIA FIBERGLASS



SEKERA ŠTIEPACIA FIBERGLASS



· násada fiberglass

Č.p.	špecifikácia	
19392	1000 g	6

Č.p.	špecifikácia	
19390	2000 g	6

· násada fiberglass

KALAČ FIBERGLASS



SEKERA FIBERGLASS



· násada fiberglass

Č.p.	špecifikácia	
19370	3000 g	4
19371	4000 g	4

· násada fiberglass

Č.p.	špecifikácia	
19344	1250 g	6

SEKERA



SEKERA ŠTIEPACIA



Č.p.	špecifikácia	
19354	600 g	6
19356	1200 g	5
19357	1800 g	1

Č.p.	špecifikácia	
19360	2700 g	6

KLIN ŠTIEPAČÍ TORZNÝ



Č.p.	váha		
19397	2000 g	55 x 210 x 45 mm	10
19465	2500 g	65 x 230 x 45 mm	10

KLIN ŠTIEPAČÍ ŠTVORRAMENNÝ



Č.p.	váha		
19469	2500 g	165 x 87 mm	10

KLIN ŠTIEPAČÍ



Č.p.	váha		
19394	1000 g	35 x 180 x 40 mm	6
19395	2000 g	40 x 255 x 55 mm	6
19396	2500 g	40 x 260 x 55 mm	10

KLIN NYLONOVÝ



Č.p.	špecifikácia	
19462	175 x 65 x 20 mm	1
19463	230 x 70 x 30 mm	1
19464	240 x 75 x 40 mm	1

FESTA®



PÁČIDLO

PÁČIDLO

14 mm

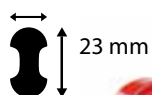

Č.p.	špecifikácia	
19424	400 mm	6
19425	600 mm	6
19426	800 mm	6
19427	1000 mm	6



Č.p.	špecifikácia	
19416	600 mm Ø 16 mm	4
19422	800 mm Ø 16 mm	4
19421	1000 mm Ø 18 mm	4

VYŤAHOVÁK PÁČIDLO

NEW



Č.p.	špecifikácia	
19423	380 x 35 x 6 mm	6

VYŤAHOVÁK PÁČIDLO



Č.p.	špecifikácia	
19415	300 mm Ø 15 mm	6

SEKÁČ PLOCHÝ

FESTA

CrV



Č.p.	špecifikácia	šírka hrotu	
19406	300 mm	25 mm	5
19407	400 mm	30 mm	5

SEKÁČ ŠPICATÝ

FESTA

CrV



Č.p.	špecifikácia	
19408	250 mm	5
19409	350 mm	5

SEKÁČ PLOCHÝ

FESTA

CrV



Č.p.	špecifikácia	šírka hrotu	
19460	300 mm	25 mm	5
19470	400 mm	30 mm	5

SEKÁČ ŠPICATÝ



Č.p.	špecifikácia	
19400	250 mm	12
19403	350 mm	6

SEKÁČ PLOCHÝ



Č.p.	špecifikácia	šírka hrotu	
19401	250 mm	19 mm	12
19404	350 mm	22 mm	6

SEKÁČ PLOCHÝ



Č.p.	špecifikácia	šírka hrotu	
19402	250 mm	50 mm	6
19405	350 mm	50 mm	6

SEKÁČ PLOCHÝ

FESTA

CrV



Č.p.	špecifikácia	šírka hrotu	
19410	200 mm	20 mm	10
19411	250 mm	25 mm	10
19412	300 mm	25 mm	10
19418	400 mm	25 mm	5
19419	500 mm	25 mm	5

SEKÁČ ZÁMOČNÍCKY PLOCHÝ

CrV



Č.p.	špecifikácia	šírka hrotu	
19436	200 mm	20 mm	15



DLÁTA

FESTA®

SADA DLÁT S BRÚSIKOM

FESTA®

CrV 5x

- 6 mm
- 10 mm
- 15 mm
- 20 mm
- 25 mm



Č.p. špecifikácia
19451

10

SADA DLÁT

FESTA®

CrV 4x

- 6 mm
- 12 mm
- 19 mm
- 25 mm



Č.p. špecifikácia
19457

10

DLÁTO

FESTA®

CrV



Č.p.	špecifikácia		Č.p.	špecifikácia	
19490	6 mm 275 mm	6	19496	18 mm 280 mm	6
19491	8 mm 275 mm	6	19497	20 mm 280 mm	6
19492	10 mm 275 mm	6	19498	22 mm 280 mm	6
19493	12 mm 275 mm	6	19499	25 mm 280 mm	6
19494	14 mm 275 mm	6	19501	32 mm 290 mm	6
19495	16 mm 275 mm	6	19502	38 mm 290 mm	6

DLÁTO STOLÁRSKE MULTIFUNKČNÉ

FESTA®

INOX



Č.p. špecifikácia
16231 20 | 80 mm



12

SADA DLÁT

4x

- 8 mm
- 12 mm
- 19 mm
- 25 mm



Č.p. špecifikácia
19450



20

SADA DLÁT

4x

- 8 mm
- 12 mm
- 19 mm
- 25 mm



Č.p. špecifikácia
19455



30

SADA SÚSTRUŽNÍCKYCH DLÁT



HOBLÍK KLOPKÁR



CrV

8x



Č.p.	špecifikácia	
19510	220 x 65 x 130 mm, nůž 48 mm	1

HOBLÍK - HLADÍK



Č.p.	špecifikácia	
19458	365 125mm	1



SADA REZBÁRSKYCH DLÁT

CrV

12x



Č.p.	špecifikácia	
19515	200 x 55 x 130 mm, nůž 39 mm	1

HOBLÍK RÍMSOVNÍK



Č.p.	špecifikácia	
19459		5



Č.p.	špecifikácia	
19520	225 x 27 x 155 mm, nůž 27 mm	1

SADA KLAMPIARSKA

7x



Č.p.	špecifikácia	
19110		5







FESTA®



SPONKOVAČKY

SPONKOVAČKA 5 V 1



-  | 6 - 14 mm
23960 - 23964
23760 - 23764,
23906 - 23914
-  | 10 - 14 mm
23965
-  | 15 mm
23966
-  | 15 mm
23967

Č.p. špecifikácia





23927



6

SPONKOVAČKA 4 V 1



-  | 6 - 14 mm
23960 - 23964
-  | 12 mm
23965
-  | 14 mm
23966
-  | 14 mm
23967

Č.p. špecifikácia



23924



12

SPONKOVAČKA 3 V 1



-  | 6 - 14 mm
23960 - 23964
-  | 14 mm
23966
-  | 14 mm
23967

Č.p. špecifikácia

23923



12

SPONKOVAČKA



-  53 | 4 - 14 mm
23904 - 23914,
23760 - 23765

Č.p. špecifikácia

23925

4 - 14 mm s aretáciou



20



ODSTRAŇOVAČ SPON



Č.p. špecifikácia

23945



25

SPONKOVAČKA



53 | 4 - 14 mm
23760 - 23765,
23904 - 23914

Č.p.	špecifikácia	
23800		20

SPONKOVAČKA

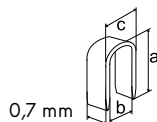
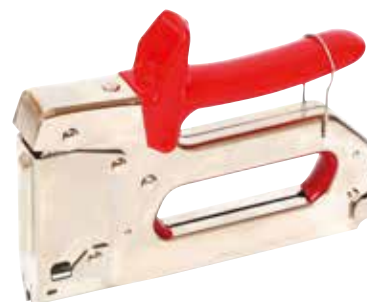

0,7 mm
53 | $a=9-11$ mm, $b=5,5$ mm, $c=6,4$ mm

Č.p.	špecifikácia	
23920		4

KLADIVO SPONKOVACIE

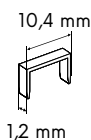

53 | 6 - 10 mm
23960 - 23962

Č.p.	špecifikácia	
23922		10

KLADIVO SPONKOVACIE

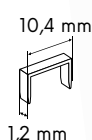

53 | 6 - 10 mm
23960 - 23962

Č.p.	špecifikácia	
23928		6

SPONY EXTRA

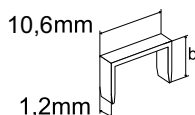

Č.p.	špecifikácia	
23960	b=6 mm, 1000 ks	50
23961	b=8 mm, 1000 ks	50
23962	b=10 mm, 1000 ks	50
23963	b=12 mm, 1000 ks	50
23964	b=14 mm, 1000 ks	50

SPONY

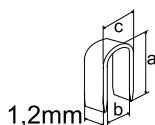

Č.p.	špecifikácia	
23965	$a=12$ mm, $b=6,5$ mm, $c=7,5$ mm, 1000 TW	50

KLINCE



Č.p.	špecifikácia	
23966	klince nails 14 mm 1000 TW	100

KLINCE



Č.p.	špecifikácia	
23967	hřeby nails 14 mm 1000 TW	100

SPONY - TYP 53

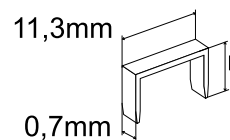

Č.p.	špecifikácia	
23904	b=4 mm 1000 ks	200
23906	b=6 mm 1000 ks	200
23908	b=8 mm 1000 ks	200
23910	b=10 mm 1000 ks	200
23912	b=12 mm 1000 ks	200
23914	b=14 mm 1000 ks	200

SPONY - TYP 53

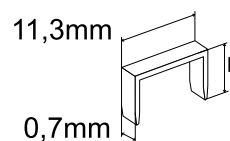

Č.p.	špecifikácia	
23760	b=4 mm 2000 ks	10
23761	b=6 mm 2000 ks	10
23762	b=8 mm 2000 ks	10
23763	b=10 mm 2000 ks	10
23764	b=12 mm 2000 ks	10

KLADIVO SPONKOVACIE



 140 | 6 - 10 mm
24535-24537,
24540-24542,
24567

Č.p. špecifikácia 
24510 20

KLADIVO SPONKOVACIE



 13 | 4 - 6 mm
24530
24533

Č.p. špecifikácia 
24511 20

SPONKOVAČKA



 140 | 6 - 14 mm
24535-24539,
24540-24543,
24567

Č.p. špecifikácia 
24515 20

SPONKOVAČKA



 140 | 6 - 8 mm
24535-24536,
24540-24541,
24567

Č.p. špecifikácia 
24516 20

SPONKOVAČKA



 13 | 4 - 10 mm
24530 - 24534

Č.p. špecifikácia 
24520 20

SPONKOVAČKA



 53 | 6 - 14 mm
24545 - 24547,
24555 - 24558,
24551 - 24552,
24568 - 24569

 8 | 15 mm
24570

Č.p. špecifikácia 
24517 20



SPONKOVAČKA

Rapid

SPONKOVAČKA

Rapid



53

| 6 - 14 mm
24545 - 24547,
24555 - 24558,
24551 - 24552,
24568 - 24569



Č.p. špecifikácia
24518

20



13

| 4 - 8 mm
24530 - 24531,
24533 - 24534



Č.p. špecifikácia
24521

20



SPONKOVAČKA

Rapid

SPONKOVAČKA

Rapid



53

| 6 - 12 mm
24545 - 24547,
24555 - 24557,
24551 - 24551,
24568 - 24569



Č.p. špecifikácia
24522

20



7

| 12 - 14 mm
24570



8

| 15 mm
24570



9

| 15 mm
24570

Č.p. špecifikácia
24522



53

| 4 - 10 mm
24550,
24545 - 24547,
24555 - 24557



Č.p. špecifikácia
24519

20

SPONY HIGH PERFORMANCE - TYP 53

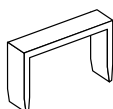

Č.p.	dĺžka	blister ks	
24550	4 mm	1620	10
24545	6 mm	2130	10
24555	6 mm	5000	10
24546	8 mm	2130	10
24556	8 mm	5000	10
24547	10 mm	2130	10
24557	10 mm	5000	10
24551	12 mm	1080	10
24558	12 mm	5000	10
24552	14 mm	1080	10
24553	20 mm	540	10

SPONY NEREZ - TYP 53 INOX



INOX

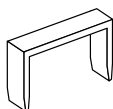

Č.p.	dĺžka	blister ks	
24568	6 mm	1080	10
24569	8 mm	1080	10

SPONY HIGH PERFORMANCE - TYP 140

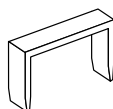

Č.p.	dĺžka	blister ks	
24535	6 mm	970	10
24540	6 mm	5000	10
24536	8 mm	970	10
24541	8 mm	5000	10
24537	10 mm	648	10
24542	10 mm	5000	10
24538	12 mm	648	10
24543	12 mm	5000	10
24539	14 mm	648	10

SPONY NEREZ - TYP 140 INOX



INOX

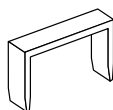

Č.p.	dĺžka	blister ks	
24567	10 mm	650	10

SPONY HIGH PERFORMANCE - TYP 13

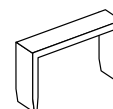

Č.p.	dĺžka	blister ks	
24530	6 mm	1650	10
24533	6 mm	5000	10
24531	8 mm	1650	10
24534	8 mm	5000	10
24532	10 mm	1100	10



SPONY HIGH PERFORMANCE - TYP 606

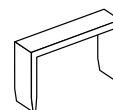

Č.p.	dĺžka	blister ks	
24560	12 mm	1200	10
24561	18 mm	600	10
24562	25 mm	600	10

SPONY HIGH PERFORMANCE - TYP 90

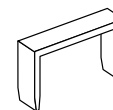

Č.p.	dĺžka	blister ks	
24580	20 mm	3000	10
24581	25 mm	3000	10
24582	30 mm	3000	10
24583	35 mm	1500	10
24584	40 mm	1500	10

SPONY HIGH PERFORMANCE - TYP 8



Č.p.	dĺžka	blister ks	
24570	15 mm	1000	10
24571	20 mm	750	10
24572	25 mm	1000	10
24573	30 mm	1000	10
24577	40 mm	2800	10
24578	50 mm	2800	10

SPONY NEREZ - TYP 8 INOX



INOX



Č.p.	dĺžka	blister ks	
24575	30 mm	4200	10

SPONY HIGH PERFORMANCE - TYP 7

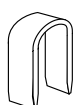

Č.p.	dĺžka	blister ks	
24565	14 mm	960	10

SPONY HIGH PERFORMANCE - TYP 9



Č.p.	dĺžka	blister ks	
24574	15 mm	1000	10



KLINCE - TYP F

NEW

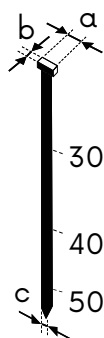

a 2,0 mm
b 1,25 mm
c 0,95 mm

SPONY

NEW

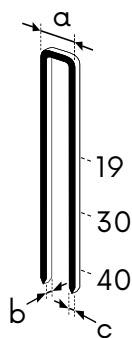

a 5,7 mm
b 1,25 mm
c 0,95 mm

pro AKU klincovačku 28070

Č.p.	špecifikácia	
23930	30 mm - 6000 ks	1
23931	40 mm - 6000 ks	1
23932	50 mm - 6000 ks	1

pro AKU klincovačku 28070

Č.p.	špecifikácia	
23934	19 mm - 3000 ks	1
23935	30 mm - 3000 ks	1
23936	40 mm - 3000 ks	1



SVORKY A ZVERÁKY

SVORKA RÝCHLOUPÍNACIA

· kovaná

FESTA

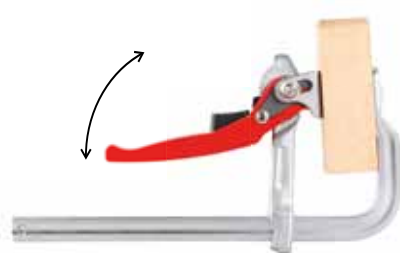

Č.p.	špecifikácia		Č.p.	špecifikácia	
23560	200 x 80 mm	1	23564	600 x 120 mm	1
23561	300 x 100 mm	1	23565	800 x 120 mm	1
23562	400 x 100 mm	1	23566	1000 x 120 mm	1
23563	500 x 120 mm	1			

SVORKA RÝCHLOUPÍNACIA

NEW



FESTA



Č.p.	špecifikácia	
23570	100 x 80 mm	1
23571	160 x 80 mm	1
23572	200 x 80 mm	1
23573	250 x 80 mm	1
23574	300 x 80 mm	1

SVORKA STOLÁRSKA



FESTA



Č.p.	špecifikácia		Č.p.	špecifikácia		Č.p.	špecifikácia	
23670	150 x 105 mm	1	23676	500 x 175 mm	1	23682	1500 x 175 mm	1
23671	200 x 105 mm	1	23677	600 x 175 mm	1	23683	1750 x 175 mm	1
23672	250 x 105 mm	1	23678	700 x 175 mm	1	23684	2000 x 175 mm	1
23673	300 x 105 mm	1	23679	800 x 175 mm	1	23685	2200 x 175 mm	1
23674	350 x 105 mm	1	23680	1000 x 175 mm	1			
23675	400 x 175 mm	1	23681	1250 x 175 mm	1			

SVORKA

DIN
5117

Č.p.	špecifikácia	
23506	300 x 120 mm	10
23507	500 x 120 mm	10
23508	800 x 120 mm	6

SVORKA



Č.p.	špecifikácia		Č.p.	špecifikácia	
23515	150 x 50 mm	50	23530	300 x 50 mm	50
23520	200 x 50 mm	50	23531	300 x 120 mm	20
23525	250 x 50 mm	50	23551	500 x 120 mm	10

SVORKA RÝCHLOUPÍNACIA

FESTA



Č.p.	špecifikácia	
23625	200 mm	6
23626	300 mm	6
23628	450 mm	6
23630	600 mm	6
23632	760 mm	6

SVORKA RÝCHLOUPÍNACIA

FESTA



Č.p.	špecifikácia	
23585	150 mm	6
23587	300 mm	6
23589	450 mm	6
23591	600 mm	6

SVORKA SO ZUBOVOU POISTKOU



· rozteč 80 mm | span 80 mm

Č.p.	špecifikácia	
23605	9' 230 mm	6

SVORKA PLASTOVÁ



Č.p.	špecifikácia	
23600	4', rozteč 40 mm	20
23601	6', rozteč 50 mm	12
23602	9', rozteč 80 mm	20

G' SVORKY SADA

3x



Č.p.	špecifikácia	
23620	25 mm, 50 mm, 75 mm	6

ZVERÁK

FESTA

· tvrdené čeľuste



Č.p.	špecifikácia	
23410	100 mm	1
23411	125 mm	1
23412	150 mm	1

ZVERÁK OTOČNÝ

· tvrdené čeľuste



Č.p.	špecifikácia	
23415	100 mm	1
23416	125 mm	1
23417	150 mm	1

ZVERÁK OTOČNÝ



10

Č.p.	špecifikácia
23407	65 mm

ZVERÁK POD VŔTAČKU



10

· tvrdené čeľuste

Č.p.	špecifikácia	
23400	18 80 mm	10
23401	22 100 mm	10
23402	24 125 mm	5

SVORKA ROHOVÁ 90°

ALU



· rozsah 0 - 65 mm

Č.p.	špecifikácia	
23420	65 mm	20

ZVERÁK MODELÁRSKY OTOČNÝ 360° STOLNÝ

ALU



Č.p.	špecifikácia	
23406	80 mm	24

STÓL PRACOVNÝ

· ideálny do pivničných kójí



Č.p.	špecifikácia	
23660		1

STÓL PRACOVNÝ MULTIFUNKČNÝ



Č.p.	špecifikácia	
23650		1

FESTA®

KLIŠTE NITOVACIE

KLIŠTE NITOVACIE

FESTA®
Cr-Mo

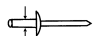

 Ø 2,4 mm
 Ø 3,2 mm
 Ø 4,0 mm
 Ø 4,8 mm

Č.p. špecifikácia
 24007 200 mm

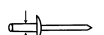

KLIŠTE NITOVACIE

FESTA®
Cr-Mo



 Ø 2,4 mm
 Ø 3,2 mm
 Ø 4,0 mm
 Ø 4,8 mm

Č.p. špecifikácia
 24010 250 mm





KLIŠTE NITOVACIE **FESTA**

Cr-Mo

INOX ALU Cu

Ø 2,4 mm
Ø 3,0 mm
Ø 3,2 mm
Ø 4,0 mm
Ø 4,8 mm

Č.p. špecifikácia
24017 280 mm

1

KLIŠTE NITOVACIE **FESTA**

Cr-Mo

INOX ALU Cu

Ø 2,4 mm
Ø 3,2 mm
Ø 4,0 mm
Ø 4,8 mm
Ø 6,4 mm

Č.p. špecifikácia
24015 530 mm

1

KLIŠTE NITOVACIE **FESTA**

Cr-Mo

ALU Cu

Ø 2,4 mm
Ø 3,0 mm
Ø 3,2 mm
Ø 4,0 mm
Ø 4,8 mm

Č.p. špecifikácia
24030 260 mm

24

KLIŠTE NITOVACIE **FESTA**

Cr-Mo

ALU Cu

nastavitelná hlava kliešťa
2 pozície

Č.p. špecifikácia
24002 260 mm

6

KLIŠTE NITOVACIE **FESTA**

Cr-Mo

ALU Cu

Ø 2,4 mm
Ø 3,2 mm
Ø 4,0 mm
Ø 4,8 mm

Č.p. špecifikácia
24006 250 mm

12

KLIŠTE NITOVACIE + NITY

Cr-Mo

ALU Cu

Ø 2,4 x 6 mm
Ø 3,2 x 6 mm
Ø 4,0 x 6 mm
Ø 4,8 x 6 mm

Č.p. špecifikácia
24005 260 mm

24

KLIŠTE NITOVACIE S OTOČNOU HLAVOU **FESTA**

Cr-Mo

ALU Cu

Č.p. špecifikácia
24020 290 mm

8

KLIŠTE NITOVACIE PEVNÉ

ALU

Č.p. špecifikácia
24001 260 mm

6

KLIŠTE NITOVACIE

ALU

Č.p. špecifikácia
24000 250 mm

24

KLIŠTE NITOVACIE PRE NITOVACIE MATICE

FESTA

Cr-Mo

- M3
- M4
- M5
- M6
- M8
- M10



Č.p. 24036
špecifikácia 330 mm



1

KLIŠTE NITOVACIE PRE NITOVACIE MATICE

FESTA

Cr-Mo

- M3
- M4
- M5
- M6



Č.p. 24035
špecifikácia 200 mm



1

HLAVICE DO NITOVACÍCH KLIŠTÍ PRE NITOVACIE MATICE

Cr-Mo

FESTA

ALU

20x

• vhodné pre 24035, 24036

Č.p.	špecifikácia	
24038	M3	1
24039	M4	1
24040	M5	1
24041	M6	1
24042	M8	1
24043	M10	1

NITOVACIE MATICE, 20 KS

Č.p.	špecifikácia	
23950	M3 x 9 mm	20
23951	M4 x 11 mm	20
23952	M5 x 12 mm	50
23953	M6 x 14 mm	50
23954	M8 x 16,5 mm	25
23955	M10 x 18 mm	20

NITY HLINÍKOVÉ TRHACIE

ALU

50x

Č.p.	špecifikácia	
23970	3,2 x 6 mm	25
23971	3,2 x 8 mm	25
23972	3,2 x 10 mm	25
23973	3,2 x 12 mm	25
23974	3,2 x 14 mm	25
23975	4,0 x 6 mm	25
23976	4,0 x 8 mm	25
23977	4,0 x 10 mm	25
23978	4,0 x 12 mm	25
23979	4,0 x 14 mm	25
23985	4,8 x 6 mm	25
23986	4,8 x 8 mm	25
23987	4,8 x 10 mm	25
23988	4,8 x 12 mm	25
23989	4,8 x 14 mm	25



KLIEŠTE SPOJOVACIE NA PROFILY PERFORAČNÉ

FESTA

Č.p. 17187
špecifikácia 350 mm



6

KLIEŠTE SPOJOVACIE NA PROFILY PERFORAČNÉ

FESTA

Č.p. 17188
špecifikácia 250 mm



6

KLIEŠTE NA HMOŽDINKY



Č.p. 17189
špecifikácia 255 mm



12

ŠTAHOVÁK NA LOŽISKÁ - DVOJRAMENNÝ

ŠTAHOVÁK NA LOŽISKÁ - TROJRAMENNÝ



Č.p.	max. priemer	hlbka	1
23734	Ø 100 mm	50-95 mm	1
23735	Ø 150 mm	100-150 mm	1
23736	Ø 200 mm	110-190 mm	1



Č.p.	max. priemer	hlbka	12
23730	Ø 100 mm	50-95 mm	12
23731	Ø 150 mm	100-150 mm	2
23732	Ø 200 mm	110-190 mm	2

ZVÁRACÍ INVERTOR TIG / MMA 160 A

FESTA®



Napätie / frekvencia:	230 V / 50 Hz
Napätie naprázdno:	55 V
Regulačný rozsah zväracích prúdov	10 - 160 A
Priemer elektródy:	1,5 - 4,0 mm
Pracovný cyklus:	TIG - 160 A / 60%, MMA - 140 A / 60%
Trieda ochrany:	IP 21
Druh zvärania:	TIG / MMA
Rozmery:	405 x 165 x 270 mm
Technológia:	Anti-stick, Arc-force, Hot start, Lift TIG
Hmotnosť:	6 kg

Č.p.	špecifikácia	
70040	Zvärací inverter TIG / MMA 160A	1
70045	Zväracie káble náhradné	1
70046	Horák TIG náhradný	1



ELEKTRÓDA RUTILOVÁ ER 117



certifikované

ELEKTRÓDA BÁZICKÁ



certifikované

Č.p.	špecifikácia	ks	
70021	Ø 2,0 x 300 mm	10 ks	1
70020	Ø 2,0 x 300 mm	2,5 kg	8
70026	Ø 2,5 x 300 mm	10 ks	1
70025	Ø 2,5 x 300 mm	2,5 kg	8
70033	Ø 3,2 x 350 mm	10 ks	1
70032	Ø 3,2 x 350 mm	5 kg	4

Č.p.	špecifikácia	ks	
70030 NEW	Ø 2,0 x 300 mm	2,5 kg	1
70031 NEW	Ø 2,0 x 300 mm	5 kg	1
70035	Ø 2,5 x 300 mm	2,5 kg	8
70036	Ø 2,5 x 300 mm	10 ks	1
70037	Ø 3,2 x 350 mm	5 kg	5
70038	Ø 3,2 x 350 mm	10 ks	1

KUKLA SAMOSTMIEVACIA ZVÁRAČSKÁ

FESTA
**CE EN
379**

LCD display



Veľkosť zorného poľa:	98 x 80 mm
Rýchlosť zatmavenia filtra:	1/25 000 s
Zatmavenia filtra:	DIN 5-8 / 9-13
UV / IR ochrana:	DIN 16
Optická trieda:	1 1 1 2
Počet senzorov:	4
Napájanie:	Solárny článok + vymeniteľná batéria CR2450
Pracovný režim:	Zváranie, brúsenie



Č.p.	špecifikácia	
70064	aktívna	1
70066	náhradné krycie plexisklo	1

KUKLA SAMOSTMIEVACIA ZVÁRAČSKÁ - CARBON

FESTA

 2x
CR2032
3V

CARBON

 7-15
shade

Č.p.	špecifikácia	
70063	aktívna	4

KUKLA SAMOSTMIEVACIA ZVÁRAČSKÁ

2x AAA

 7-15
shade

Č.p.	špecifikácia	
70060	aktívna	4

KUKLA ZVÁRAČSKÁ

 UV-IR
protection

 11
shade

Č.p.	špecifikácia	
70061		4

OKULIARE ZVÁRAČSKÉ

 UV-IR
protection

Č.p.	špecifikácia	
70062		1

SKLÍČKO NÁHRADNÉ KRYCIE DO ZVÁRAČSKEJ KUKLY

2x



Č.p.	špecifikácia	
70065	113 x 80 mm	20

KLADIVO ZVÁRAČSKÉ



Č.p.	špecifikácia	
19115	300 g	1

DRŽIAK ELEKTRODY



Č.p.	špecifikácia	
70070	300 A	1

KLIÉŠTE ZEMNIAČE



Č.p.	špecifikácia	
70075	300 A	1

MAGNET UHLOVÝ



Č.p.	špecifikácia	nosnosť	
70096	150 x 130 x 30 mm · 45°, 90°, 135°	25 kg	10

MAGNET UHLOVÝ



Č.p.	špecifikácia	nosnosť	
70090	85 x 85 mm · 45°, 90°	9 kg	10

MAGNET UHLOVÝ



Č.p.	špecifikácia	nosnosť	
70093	95 x 64 mm · 30°, 45°, 60°, 75°, 90°	9 kg	10
70094	120 x 90 mm · 30°, 45°, 60°, 75°, 90°	18 kg	10
70095	137 x 110 mm · 30°, 45°, 60°, 75°, 90°	27 kg	10

MAGNET UHLOVÝ



Č.p.	špecifikácia	nosnosť	
70091	95 x 109 x 25 mm · 45°, 90°, 135°	13 kg	10
70092	130 x 150 x 32 mm · 45°, 90°, 135°	22 kg	5

TYČ ZÁVITOVÁ NEREZOVÁ

DIN 976 INOX



4.8 · trieda pevnosti

Č.p.	špecifikácia	
55311	M 5 1 m	150
55313	M 8 1 m	50
55314	M 10 1 m	25
55315	M 12 1 m	20
55316	M 14 1 m	15
55317	M 16 1 m	15
55318	M 18 1 m	10
55319	M 20 1 m	10

TYČ ZÁVITOVÁ

DIN 975 Zn



4.8 · trieda pevnosti

Č.p.	špecifikácia	
55040	M 4 1 m	200
55050	M 5 1 m	150
55060	M 6 1 m	100
55080	M 8 1 m	50
55100	M 10 1 m	20
55120	M 12 1 m	20
55140	M 14 1 m	15
55160	M 16 1 m	15
55180	M 18 1 m	10
55200	M 20 1 m	10
55220	M 22 1 m	5
55240	M 24 1 m	5
55300	M 30 1 m	5

TYČ ZÁVITOVÁ

DIN 975



4.8 · trieda pevnosti

Č.p.	špecifikácia	
55041	M 4 1 m	200
55051	M 5 1 m	150
55101	M 10 1 m	20
55121	M 12 1 m	20
55141	M 14 1 m	15
55181	M 18 1 m	10
55201	M 20 1 m	10
55221	M 22 1 m	5
55301	M 30 1 m	5



MATICE

DIN 934

Zn



4.8 · trieda pevnosti

Č.p.	špecifikácia	
55350	M 4 100 ks	1
55351	M 5 100 ks	1
55352	M 6 100 ks	1
55353	M 8 100 ks	1
55354	M 10 100 ks	1
55355	M 12 100 ks	1
55356	M 14 100 ks	1
55357	M 16 100 ks	1
55358	M 18 100 ks	1
55359	M 20 10 ks	1
55360	M 22 10 ks	1
55361	M 24 10 ks	1
55362	M 30 10 ks	1

PODLOŽKA

DIN 440R

Zn



Č.p.	špecifikácia	
55331	M 5 100 ks	1
55332	M 6 100 ks	1
55333	M 8 100 ks	1
55334	M 10 100 ks	1
55335	M 12 100 ks	1
55336	M 14 100 ks	1
55337	M 16 100 ks	1
55339	M 20 10 ks	1
55340	M 22 10 ks	1
55341	M 24 10 ks	1
55342	M 30 10 ks	1



KOMPRESOR 6 L - BEZOLEJOVÝ

FESTA



Napätie / frekvencia:	230 V / 50Hz
Príkion:	1,2 kW (1,5HP)
Objem nádrže:	6 l
Max. tlak:	8 Bar
Otáčky:	3900 min.
Sací výkon:	180 l/min.
Plniaci výkon:	116 l/min.
Hmotnosť:	10 kg

Č.p.

35360



1



KOMPRESOR 24 L - BEZOLEJOVÝ



Výkon:	1100 W
Napájanie:	230 V / 50Hz
Beh bez záťaže:	2850 min-1
Pracovný tlak:	8 bar
Voľný prívod vzduchu:	160 l / min
Typ:	bezolejový
Kapacita zásobníka:	24 L
Hmotnosť:	23 kg

Č.p.

35361 1,1 kW, 24 l



1

KOMPRESOR 24 L



Výkon:	1500 W
Napájanie:	230 V / 50Hz
Beh bez záťaže:	2850 min-1
Pracovný tlak:	8 bar
Voľný prívod vzduchu:	200 l / min
Typ:	olejový
Kapacita zásobníka:	24 L
Hmotnosť:	24 kg

Č.p.

35362 1,5 kW, 24 l



1

KOMPRESOROVÁ SADA

FESTA
5x

- Postrekovacia pištoľ so spodnou nádržkou
- Fúkacia pištoľ s manometrom
- Postrekovacia pištoľ s hornou nádržkou
- Ofukovacia pištoľ
- Hadica s rýchlospojками



Č.p. špecifikácia
48001



KOMPRESOROVÁ SADA

FESTA
3x

- Fúkacia pištoľ s manometrom
- Ofukovacia pištoľ
- Hadica s rýchlospojками



Č.p. špecifikácia
48002



STRIEKACIA PIŠTOĽ

FESTA



Č.p. špecifikácia
48015 spodná



PIŠTOĽ NA SPODKY A DUTINY

FESTA

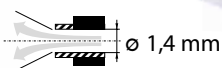
Č.p. špecifikácia
48036 spodná



STRIEKACIA PIŠTOĽ

FESTA



Č.p. 48020
špecifikácia horná



STRIEKACIA PIŠTOĽ

FESTA



Č.p. 48021 48047
špecifikácia horná náhradná tryska Ø 1,7 mm

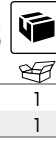

STRIEKACIA PIŠTOĽ

FESTA



Č.p. 48022 48046
špecifikácia horná náhradná tryska Ø 1,5 mm



STRIEKACIA PIŠTOĽ

FESTA



Č.p. 48003
špecifikácia



STRIEKACIA PIŠTOĽ NA FARBY A OMIETKY

NEW



- 4 - 6 Bar
- 5 l
- tryska Ø 4; 6; 8 mm

Č.p. 48037
špecifikácia



PIŠTOĽ OFUKOVACIA

FESTA



Č.p. 48005
špecifikácia krátka



PIŠTOĽ OFUKOVACIA

FESTA



Č.p. 48006
špecifikácia stredná



PIŠTOĽ OFUKOVACIA

FESTA



Č.p. 48007
špecifikácia dlhá



PIŠTOĽ FÚKACIA S MANOMETROM

FESTA

Č.p.	špecifikácia
48010	



1

HADICA S RÝCHLOSPOJKAMI

FESTA
NEW

· max. 20 Bar

Č.p.	špecifikácia		
48031	5 m	ø 9/15 mm	1
48032	10 m	ø 9/15 mm	1
48033	15 m	ø 9/15 mm	1
48034	20 m	ø 9/15 mm	1

HADICA S RÝCHLOSPOJKAMI

FESTA

Č.p.	špecifikácia	svetlosť Ø
48043	5 m 8 atm	10 mm



1

HADICA S RÝCHLOSPOJKAMI

FESTA

Č.p.	špecifikácia	svetlosť Ø	
48040	5 m 8 atm	8 mm	1
48041	10 m 8 atm	8 mm	1
48042	15 m 8 atm	8 mm	1

FILTER



· maximálny tlak 10 bar

Č.p.	špecifikácia
48008	G 1/4'



1

REGULÁTOR TLAKU S MANOMETROM



· pracovný tlak 0 - 10 bar

Č.p.	špecifikácia
48009	G 1/4'



1

TRYSKY NÁHRADNÉ

FESTA

· vhodné pre 48021

Č.p.	špecifikácia
48047	tryska Ø 1,7 mm



1

TRYSKY NÁHRADNÉ

FESTA

· vhodné pre 48022

Č.p.	špecifikácia
48046	tryska Ø 1,5 mm



1

TABUĽKA ROZMEROV RÚRKOVÝCH ZÁVITOV WHITWORTH

VEĽKOSŤ ZÁVITU G V PALCOCH	MAXIMÁLNY VONKAJŠÍ Ø ZÁVITU V MM
1/8	9,728
1/4	13,157
3/8	16,662
1/2	20,955
3/4	26,441
1	33,249

RÝCHLOSPOJKA

REDUKCIA

ŠRÚBENIE S VONKAJŠÍMI ZÁVITMI



Č.p.	špecifikácia	
48075	1/4' vonkajší	10
48076	3/8' vonkajší	10
48077	1/2' vonkajší	10
48095	1/4' vnútorný	10
48096	3/8' vnútorný	10
48097	1/2' vnútorný	10

Č.p.	špecifikácia	
48054	3/8' vonkajší x 1/4' vnútorný	10
48055	1/2' vonkajší x 3/8' vnútorný	10
48056	redukcia 3/8' vonkajší x 1/2' vnútorný	10
48057	redukcia 1/4' vonkajší x 3/8' vnútorný	10

Č.p.	špecifikácia	
48050	spojka 1/4' vonkajší x 1/4' vonkajší	10
48051	redukcia 1/4' vonkajší x 3/8' vonkaj.	10

RÝCHLOSPOJKA | HADICOVÁ VSUVKA

ADAPTÉR RÝCHLOSPOJKY | HADICOVÁ VSUVKA



Č.p.	špecifikácia	
48070	1/4' - 6 mm	10
48071	3/8' - 9 mm	10
48072	1/2' - 13 mm	10

Č.p.	špecifikácia	
48085	1/4' - 6 mm	10
48086	3/8' - 9 mm	10
48087	1/2' - 13 mm	10

ADAPTÉR RÝCHLOSPOJKY

HADICOVÁ VSUVKA

Č.p.	špecifikácia	
48080	1/4' vonkajší	10
48081	3/8' vonkajší	10
48090	3/8' vnútorný	10
48091	1/4' vnútorný	10

Č.p.	špecifikácia	
48060	Ø 6 mm - 1/8' vonkajší	10
48061	Ø 6 mm - 1/4' vonkajší	10
48062	Ø 6 mm - 3/8' vonkajší	10
48063	Ø 9 mm - 1/4' vonkajší	10
48064	Ø 9 mm - 3/8' vonkajší	10
48065	Ø 13 mm - 1/4' vonkajší	10
48066	Ø 13 mm - 3/8' vonkajší	10
48067	Ø 6 mm - 3/8' vnútorný	10
48068	Ø 9 mm - 3/8' vnútorný	10
48093	Ø 6 mm - 1/4' vnútorný	10
48094	Ø 9 mm - 1/4' vnútorný	10



OCHRANNÉ POMÔCKY

OKULIARE ZJASŇOVACIE LASEROVÝ LÚČ

CE EN
166

Laserliner®



Č.p.	špecifikácia	
26021	červené	12

OKULIARE OCHRANNÉ

CE EN
166



Č.p.	špecifikácia	
50510		10

OKULIARE OCHRANNÉ

CE EN
166





Č.p.	špecifikácia	
50514		10

OKULIARE OCHRANNÉ

CE EN
166



 nastaviteľná dĺžka straničiek

Č.p.	špecifikácia	
50511		12

OKULIARE OCHRANNÉ

CE EN
170



Č.p.	špecifikácia	
50512	tmavé	12

OKULIARE OCHRANNÉ

CE EN
166



Č.p.	špecifikácia	
50513		1

SLÚCHADLÁ OCHRANNÉ

CE EN
352

27
dB



Č.p. špecifikácia
50563

1

SLÚCHADLÁ OCHRANNÉ

CE EN
352

27
dB



Č.p. špecifikácia
50564

1

ŠTÍT OCHRANNÝ PE

CE EN
166



Č.p. špecifikácia
50556

1

PRILBA OCHRANNÁ CLIMAX

CE EN
397



Č.p.	špecifikácia	
50550	modrá	30
50551	červená	30
50553	biela	30
50554	žltá	30

ŠTÍT OCHRANNÝ S MREŽKOU

CE
EN 1731



Č.p. špecifikácia
50562

1

VESTA REFLEXNÁ

CE EN
20471



Č.p.	špecifikácia	
50570	oranžová	100
50571	žltá	100

ZÁTKY DO UŠÍ



Č.p. špecifikácia
50560

100

ZÁTKY DO UŠÍ NA ŠNÚRKE



Č.p. špecifikácia
50559

100

RESPIRÁTOR

CE EN
149



RESPIRÁTOR

CE EN
149



RÚŠKA - ÚSTENKA

50x



Č.p.	špecifikácia	
50500	FFP2 bez ventilu	30
50501	FFP1 bez ventilu	30

Č.p.	špecifikácia	
50502	FFP1 s ventilom	20
50503	FFP2 s ventilom	20

Č.p.	špecifikácia	
50505		40

MOQ
40



RUKAVICE KOŽENÉ, ZOSILNENÉ

CE EN
166



S podšívkou v dlani



RUKAVICE KOŽENÉ, ZOSILNENÉ

CE EN
388



S podšívkou v dlani



RUKAVICE KOŽENÉ

CE EN
388



Č.p.	špecifikácia	
50518	veľkosť 11"	12

Č.p.	špecifikácia	
50519	veľkosť 10,5"	12

Č.p.	špecifikácia	
50520	veľkosť 10,5"	12

RUKAVICE KOŽENÉ

CE EN
388



RUKAVICE KOŽENÉ, S TEPLOU PODŠÍVKOU

CE EN
388



BAVLNENÉ RUKAVICE S PVC TERČÍKMI

Č.p.	špecifikácia	
50521	veľkosť 10,5"	12

Č.p.	špecifikácia	
50523	veľkosť 11"	12

Č.p.	špecifikácia	
50524	veľkosť 10"	12



UKAVICE BAVLENÉ MÁČANÉ V PVC

CE EN
388



Č.p. 50525 špecifikácia veľkosť 10" - dĺžka 35 cm 12

UKAVICE POLYESTER S PVC TERČÍKMI

· S PVC terčíkmi



Č.p. 50526 špecifikácia veľkosť 10" 12

UKAVICE BAVLENÉ MÁČANÉ V LATEXE

CE EN
388



Č.p. 50522 špecifikácia veľkosť 10" 12

UKAVICE NYLONOVÉ MÁČANÉ V NITRILE

CE EN
388



Č.p. 50533 špecifikácia veľkosť 10" 12

UKAVICE NYLON MÁČANÉ V LATEXOVEJ PENE

CE EN
388



Č.p. 50537 špecifikácia veľkosť 10" 12

UKAVICE NYLON MÁČANÉ V NITRILovej PENE

CE EN
388



Č.p. 50539 špecifikácia veľkosť 10" 12

UKAVICE ZIMNÉ AKRYLOVÉ, MÁČANÉ V LATEXE

CE EN
388



Č.p. 50529 špecifikácia veľkosť 10" 12

UKAVICE ZÁHRADNÉ



Č.p. 50557 špecifikácia veľkosť 7" 12
50558 veľkosť 8" 12
50549 veľkosť 9" 12

UKAVICE BAVLENÉ

· S PVC terčíkmi

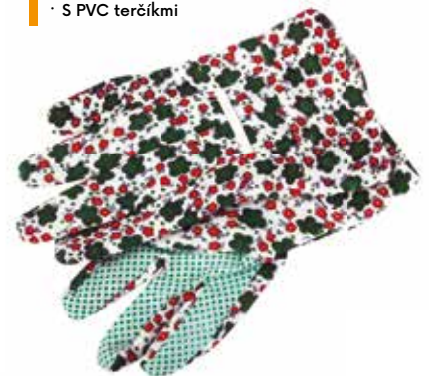

Č.p. 50531 špecifikácia veľkosť 9" 12

RUKAVICE MECHANIK – KOZIA KOŽA



Č.p.	špecifikácia	
50541	veľkosť 9"	12
50542	veľkosť 10"	12

RUKAVICE MECHANIK, NYLON - BRAVČOVINA



Č.p.	špecifikácia	
50544	veľkosť 10"	12

RUKAVICE -NYLON, MÁČANÉ V POLYURETÁNE



Č.p.	špecifikácia	
50527	veľkosť 10"	12

RUKAVICE ZVÁRAČSKÉ, KOŽENÉ



RUKAVICE LATEXOVÉ JEDNORAZOVÉ



RUKAVICE VINYLÓVÉ JEDNORAZOVÉ



Č.p.	špecifikácia	
50540	veľkosť 11"	12

Č.p.	špecifikácia	
50530		200

Č.p.	špecifikácia	
50532	číre, nepudrované	100

OCHRANNÁ KOMBINÉZA S KAPUČNOU



Č.p.	špecifikácia	
50585	veľkosť M	1
50586	veľkosť L	1
50587	veľkosť XL	1
50588	veľkosť XXL	1

ZÁSTERA NA ZVÁRANIE



Č.p.	špecifikácia	
50555	koža	1

KĽAKADLO POJAZDNÉ



Č.p. 37135 špecifikácia



OCHRANA KOLIEN

FESTA



Č.p. 37145 špecifikácia gel



OCHRANA KOLIEN

FESTA

OCHRANA KOLIEN

FESTA

OCHRANA KOLIEN

FESTA



Č.p. 37140 špecifikácia gel



Č.p. 37144 špecifikácia gel



Č.p. 37143 špecifikácia



OCHRANA KOLIEN

FESTA

OCHRANA KOLIEN

OCHRANA KOLIEN



Č.p. 37142 špecifikácia komfort



Č.p. 37139 špecifikácia neopren



Č.p. 37141 špecifikácia



TAŠKA NA NÁRADIE S KOVOVOU RUKOVÄŤOU

FESTA®

· kvalitná kovová rukoväť, polstrovaná

· popruhy so suchým zipsom pre upevnenie dlhého náradia

· pohodlný ramenný, odnímateľný popruh

· vystužená vnútorná konštrukcia

Č.p.	výška	dĺžka	hlbka
37331	280 mm	490 mm	230 mm



2



OPASOK SO SPONOU

FESTA®

Č.p.	špecifikácia
37328	145 cm



1

PUZDRO NÁRAĎOVÉ

FESTA®

· vystužené vrecká



10

Č.p.	špecifikácia
37325	

PUZDRO NÁRAĎOVÉ

FESTA®

· vystužené vrecká



12

Č.p.	špecifikácia
37326	

TAŠKA

NEW

FESTA®



Č.p.	šírka	výška	hlbka
37332	480 mm	290 mm	250 mm



1

TAŠKA

FESTA®



Č.p.	šírka	výška	hlbka
37330	610 mm	400 mm	270 mm



5

OPASOK MONTÁŽNY - SADA

FESTA®

· 14 vreciek + oko



Č.p.	dĺžka	šírka
37311	120 cm	6 cm



1

PUZDRO NÁRAĎOVÉ



· 8 vreciek



Č.p.	šírka	výška
37320	300 mm	250 mm

1

PUZDRO NÁRAĎOVÉ



· 4 vrecká



Č.p.	šírka	výška
37321	350 mm	300 mm

1

PUZDRO NA DROBNÉ NÁRADIE



PUZDRO SO SPONOU



PUZDRO UNIVERZÁLNE



Č.p.	šírka	výška
37314	150 mm	250 mm

1



Č.p.	šírka	výška
37312	10 mm	210 mm

1



Č.p.	šírka	výška
37313	85 mm	160 mm

1

OPASOK NYLONOVÝ



VESTA PRACOVNÁ



Č.p.	dĺžka	šírka
37310	120 cm	6 cm

1



Č.p.	špecifikácia
37350	

1

PÁS NÁRAĎOVÝ KOŽENÝ

FESTA®



Č.p.	špecifikácia	
37302	6 vreciek	50
37303	11 vreciek	25

PÁS NÁRAĎOVÝ KOŽENÝ



Č.p.	špecifikácia	
37300	6 vreciek	50
37301	11 vreciek	25

BRAŠNA KOŽENÁ PROFESIONÁLNA



Č.p.	výška	dĺžka	hlbka	
37342	270 mm	430 mm	180 mm	1

BRAŠNA PRE ELEKTRIKÁRA KOŽENÁ



Č.p.	výška	dĺžka	hlbka	
37341	260 mm	430 mm	200 mm	1



FESTA®

BRAŠNA KOŽENÁ S VYSTUŽENÝM DNOM



Č.p.	výška	dĺžka	hĺbka	
37340	240 mm	430 mm	150 mm	1

BRAŠNA REMESLNÍCKA S POPRUHOM



Č.p.	výška	dĺžka	hĺbka	
37344	250 mm	300 mm	130 mm	1

BRAŠNA S VYSTUŽENÝM DNOM



Č.p.	výška	dĺžka	hĺbka	
37343	240 mm	430 mm	150 mm	1

BRAŠNA PRE ELEKTRIKÁRA



Č.p.	výška	dĺžka	hĺbka	
37345	270 mm	430 mm	180 mm	1

SPONA - KOŽA "O"



Č.p.	špecifikácia	
37308		20

SPONA - KOŽA "U"



Č.p.	špecifikácia	
37309		20

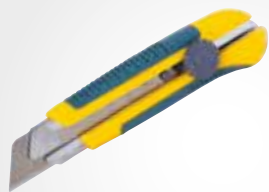

136

ODLAMOVCIE NOŽE KDS



138

ODLAMOVCIE NOŽE FESTA



144

ŠKRABKY



145

NÁHRADNÉ ČEPELE



147

NOŽE A MAČETY



152

ZVÁRAČKY, REZAČE, KLIEŠTE NA PVC RÚRKY



155

REZAČKY NA POLYSTYRÉN

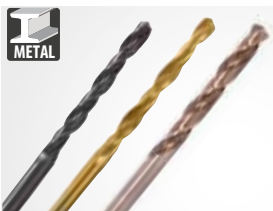

157

VRTÁKY DO KOVU



166

VYKRUŽOVÁKY, SEKÁČE, PRIEBOJNÍKY



170

DIAMANTOVÉ KORUNKY



174

VRTÁKY DO DREVA, VYKRUŽOVACIE PÍLY, FRÉZY



178

SKĽUČOVADLA

VRTÁKY, REZNÉ A BRÚSNE
NÁSTROJE

134 - 209



179

ROTAČNÉ BRÚSNE KEFY



183

BRÚSNE KOTÚČE A PAPIERE



188

RAŠPLE NA SADROKARTÓN



189

PILNÍKY A RAŠPLE



191

PÍLOVÉ KOTÚČE, PLÁTKY



194

PÍLOVÉ PLÁTKY



197

PÍLY NA DREVO, KOV A INÉ



203

DIAMANTOVÉ KOTÚČE



206

REZNÉ A BRÚSNE KOTÚČE

KDS®

Nože japonskej firmy KDS

- Vynikajúca ergonómia rúkaväti
- Vysoký výkon a životnosť britov
- Najlepšie použité materiály britov
- Nízky rezný odpor umožňujúci ľahký rez

NÔŽ ODLAMOVCÍ



KDS®

Č.p.	špecifikácia	
16002	LC405 18 mm zelený	25
16104	LC405 18 mm červený	25

Č.p.	špecifikácia	
16011	LB10 náhradné čepele	10

NÔŽ ODLAMOVCÍ

KDS®

Č.p.	špecifikácia	
16003	G11 18 mm + 2 čepele	10
16012	GB10 náhradné čepele	10

NÔŽ ODLAMOVCÍ

KDS®

Č.p.	špecifikácia	
16019	KDS/L19 18 mm + 2 čepele	10
16011	LB10 náhradné čepele	10
16012	GB10 náhradné čepele	10

NŮŽ ODLAMOVCÍ

KDS®



Č.p.	špecifikácia	
16004	H11 25 mm	10
16013	HB10 náhradné čepele	10

NŮŽ ODLAMOVCÍ

KDS®



Č.p.	špecifikácia	
16005	S14 9 mm + 2 čepele	10
16010	SB10 náhradné čepele	10

SKALPEL

KDS®



Č.p.	špecifikácia	
16006	D11 + 16 x čepeľ	10
16014	DB 48 náhradné čepele	10

ČEPELE NÁHRADNÉ KDS

KDS®

10x



Č.p.	špecifikácia	
16010	SB10 9 0,38 mm 13 segmentov	20
16011	LB10 18 0,5 mm 15 segmentov	20
16012	GB10 18 0,6 mm 15 segmentov	20
16013	HB10 25 0,7 mm 7 segmentov	10

ČEPELE NÁHRADNÉ KDS

KDS®

10x



- Špeciálna zliatina
- Dvojaké brúsenie
- Zvýšená životnosť
- Nízky rezný odpor
- Umožňujúce ľahké rezanie

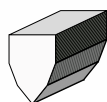

Č.p.	špecifikácia	
16016	LB10B 18 0,5 mm 8 segmentů	20
16017	HB10B 25 0,7 mm 7 segmentů	10

STOJAN NA ODLAMOVCIE NOŽE

KDS®

• osadenie stojanu 16998

- 16001 · 5 ks
- 16003 · 5 ks
- 16004 · 3 ks
- 16005 · 3 ks
- 16006 · 2 ks
- 16008 · 3 ks
- 16010 · 4 ks
- 16012 · 4 ks
- 16013 · 1 ks
- 16016 · 4 ks
- 16018 · 4 ks
- 16019 · 4 ks
- 16020 · 4 ks



• ilustračné foto

Č.p.	špecifikácia	
16999	stojan	1
16998	osadený stojan	1

FESTRA
NŮŽ ODLAMOVCÍ S KERAMICKOU ČEPELŮU
FESTRA

- 3x ostrejšie než čepeľ oceľová
- 10x dlhšia životnosť
- Žiaruvzdorná, nevodivá, nemagnetická



Č.p.	špecifikácia	
16131	18 mm	10
16066	náhradné čepeľe 18 mm, 5 ks	10

NŮŽ ODLAMOVCÍ
FESTRA



Č.p.	špecifikácia	
16110	L11 18 mm + 1 čepeľ	12

NŮŽ ODLAMOVCÍ
FESTRA

Č.p.	špecifikácia	
16100	L12 18 mm + 1 čepeľ	12

NŮŽ ODLAMOVCÍ
FESTRA

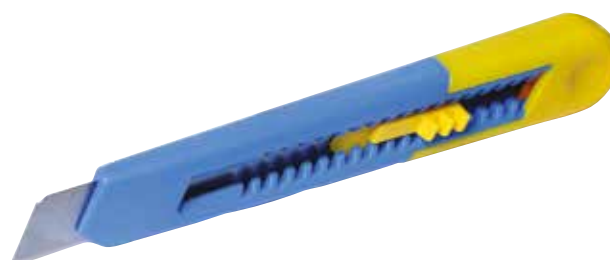
Č.p.	špecifikácia	
16105	L17 18 mm + 1 čepeľ	12

NŮŽ ODLAMOVCÍ
FESTRA

Č.p.	špecifikácia	
16125	L4 9 mm	24
16120	L8 18 mm	24

NŮŽ ODLAMOVCÍ
FESTRA

Č.p.	špecifikácia	
16115	L10 9 mm	24

NŮŽ ODLAMOVCÍ
FESTRA
ALU

Č.p.	špecifikácia	
16150	18 mm	MOQ 24
16151	18 mm bez loga FESTRA	20

NŮŽ ODLAMOVCÍ **FESTA**

NEW

ALU



Č.p. špecifikácia

16136 18 mm

1

NŮŽ ODLAMOVCÍ **FESTA**

NEW

ALU



Č.p. špecifikácia

16137 25 mm

1

NŮŽ ODLAMOVCÍ **FESTA**

+4

ALU



· Protišmykové pogumovanie

Č.p. špecifikácia

16090 18 mm

12

NŮŽ ODLAMOVCÍ **FESTA**

+4

ALU



· Protišmykové pogumovanie

Č.p. špecifikácia

16091 25 mm

6

NŮŽ ODLAMOVCÍ **FESTA**

ALU



· Protišmykové pogumovanie

Č.p. špecifikácia

16145 L25 18 mm

12

NŮŽ ODLAMOVCÍ **FESTA**

ALU



· Protišmykové pogumovanie

Č.p. špecifikácia

16144 L24 18 mm

12

NŮŽ ODLAMOVCÍ

NEW

ALU



Č.p. špecifikácia

16143 18 mm

1

NŮŽ ODLAMOVCÍ

NEW

ALU



Č.p. špecifikácia

16142 18 mm

1

NŮŽ ODLAMOVCÍ

NEW

ALU



Č.p. 16025
špecifikácia 18 mm

1

NŮŽ ODLAMOVCÍ

FESTA

ALU



Č.p. 16029
špecifikácia 18 mm

25

NŮŽ ODLAMOVCÍ

FESTA



· Protišmykové pogumovanie

Č.p. 16146
špecifikácia 18 mm

12

NŮŽ ODLAMOVCÍ

FESTA



· Protišmykové pogumovanie

Č.p. 16147
špecifikácia 25 mm

12

NŮŽ ODLAMOVCÍ

FESTA

+5



· Protišmykové pogumovanie

Č.p. 16130
špecifikácia L18 18 mm

12

NŮŽ ODLAMOVCÍ

FESTA

+5



· Protišmykové pogumovanie

Č.p. 16135
špecifikácia L20 25 mm + 5 čepeľí

6

NŮŽ ODLAMOVCÍ

FESTA



· Protišmykové pogumovanie

Č.p. 16140
špecifikácia L22 18 mm

12

NŮŽ ODLAMOVCÍ

FESTA

ALU



· Protišmykové pogumovanie

Č.p. 16034
špecifikácia 25 mm

12

NŮŽ ODLAMOVCÍ

FESTA

INOX



Č.p.	špecifikácia	
16085	9 mm	24

NŮŽ ODLAMOVCÍ

FESTA

INOX



Č.p.	špecifikácia	
16086	18 mm	24

NŮŽ BEZPEČNOSTNÝ



· samozatahovacia čepeľ

Č.p.	špecifikácia	
16057	135 mm	1

NŮŽ BEZPEČNOSTNÝ

FESTA

ALU

INOX



16074



Č.p.	špecifikácia	
16058		1
16074	náhradné čepeľe 10 ks	1

NŮŽ TURBO

FESTA

+5

ALU



Č.p.	špecifikácia	
16037		6

NŮŽ ZATVÁRACÍ

FESTA

+5

ALU



Č.p.	špecifikácia	
16023	nůž zatvárací	12
16071	náhradné čepeľe 10 ks	10

NŮŽ ZATVÁRACÍ, SADA ČEPELÍ

FESTA

ALU



Č.p.	špecifikácia	
16095	25 x čepeľ	1

NŮŽ S ARETÁCIOU

ALU

+2



FESTA

NŮŽ S ARETÁCIOU

ALU

+3



FESTA

· Protišmykové pogumovanie

Č.p. špecifikácia

16035



12

Č.p. špecifikácia

16033 NP 110



12

NŮŽ S ARETÁCIOU

ALU

+5



FESTA

NŮŽ S ARETÁCIOU

ALU



Č.p. špecifikácia

16038



12

Č.p. špecifikácia

16032 NP 109



48

NŮŽ S ARETÁCIOU

ALU



FESTA

NŮŽ

ALU



Č.p. špecifikácia

16031 NS 107 B



24

Č.p. špecifikácia

16030 NS 107



24

NŮŽ NA PODLAHOVINY



· na koberce a podlahové krytiny

Č.p. špecifikácia

16036 45 mm



12

NŮŽ HÁKOVÝ



· na koberce a podlahové krytiny

Č.p. špecifikácia

16041



12

NŮŽ ODLAMOVCÍ

ALU



Č.p.	špecifikácia	
16046	18 mm	1

NŮŽ ODLAMOVCÍ



Č.p.	špecifikácia	
16028	S 201 18 mm	24

NŮŽ ODLAMOVCÍ



Č.p.	špecifikácia	
16026	P 205 18 mm	30

NŮŽ ODLAMOVCÍ

HOBBY



Č.p.	špecifikácia	
16021	P 201 9 mm	60

NŮŽ ODLAMOVCÍ

HOBBY



Č.p.	špecifikácia	
16024	P 204 18 mm	60

NŮŽ ODLAMOVCÍ



· Protišmykové pogumovanie

Č.p.	špecifikácia	
16141	18 mm	24

MOQ
24



SADA NOŽOV

HOBBY

12x



Č.p.	špecifikácia	
16053	9 mm	12
16055	18 mm	12

SADA NOŽOV

HOBBY

3x



Č.p.	špecifikácia	
16043		24



ŠKRABKA

NEW

ALU



50 mm



Č.p.	špecifikácia	
16059	50 mm	1
16082	náhradné čepele	1

ŠKRABKA

NEW

ALU



100 mm



Č.p.	špecifikácia	
16054	100 mm	1

na použitie s 18 mm čepeľami k odlamovacím nožom

ŠKRABKA POGUMOVANÁ

FESTA



38 mm



Č.p.	špecifikácia	
16049		12
16069	náhradné čepele	1

Protišmykové pogumovanie

ŠKRABKA

FESTA



100 mm



Č.p.	špecifikácia	
16052	48 cm dĺžka	6
16070	čepeľ	25

ŠKRABKA



60 mm



Č.p.	špecifikácia	
16051		24

ŠKRABKA



55 mm



Č.p.	špecifikácia	
16050		24

SADA NA APLIKÁCIU A ODSTRÁNENIE SILIKÓNU

3x



Č.p.	špecifikácia	
16042		12

ČEPEL' NÁHRADNÁ **FESTA**

SK2

10x



- 7 segmentov
- 3x dlhšia životnosť
- dvojité brúsenie
- nízky rezný odpor

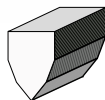

Č.p.	špecifikácia
16064	25 0,7 mm

1

ČEPEL' NÁHRADNÁ

10x



- 7 segmentov



Č.p.	špecifikácia
16068	25 0,6 mm

1

ČEPEL' NÁHRADNÁ **FESTA**

SK2

10x



- 8 segmentov
- 3x dlhšia životnosť
- dvojité brúsenie
- nízky rezný odpor

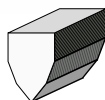

Č.p.	špecifikácia
16062	18 0,7 mm

1

ČEPEL' NÁHRADNÁ **FESTA**

SK2

10x



- 15 segmentov
- 3x dlhšia životnosť
- dvojité brúsenie
- nízky rezný odpor

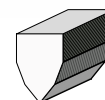

Č.p.	špecifikácia
16063	18 0,7 mm

1

ČEPEL' NÁHRADNÁ KERAMICKÁ **FESTA**

5x

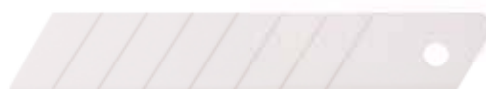

- 8 segmentov
- 3x ostrejšia než čepel' ocel'ová
- 10x dlhšia životnosť
- Žiaruvzdorná, nevodivá, nemagnetická



Č.p.	špecifikácia
16066	18 0,6 mm

10

ČEPEL' NÁHRADNÁ

10x



- 4 segmenty

10

Č.p.	špecifikácia
16067	18 0,5 mm

ČEPEL' NÁHRADNÁ

10x



- 8 segmentov



Č.p.	špecifikácia
16065	18 0,5 mm

1

ČEPEL' NÁHRADNÁ

10x



- 15 segmentov



Č.p.	špecifikácia
16081	18 0,5 mm

1

ČEPEL' NÁHRADNÁ

10x



- dvojité brúsenie

- 8 segmentov



Č.p.	špecifikácia
16078	18 0,5 mm

1

ČEPEL' NÁHRADNÁ

10x



- dvojité brúsenie

- 8 segmentov



Č.p.	špecifikácia
16077	18 0,6 mm

1

ČEPEL NÁHRADNÁ 30°

10x



ČEPEL NÁHRADNÁ

10x



· 7 segmentov



· 13 segmentov

Č.p.	špecifikácia	
16061	9 0,4 mm	1

Č.p.	špecifikácia	
16060	9 0,45 mm	10

ČEPEL NÁHRADNÁ



10x



ČEPEL NÁHRADNÁ



10x



ČEPEL NÁHRADNÁ



10x



· pre 16058

Č.p.	špecifikácia	
16074		1

Č.p.	špecifikácia	
16072	R 004	10

Č.p.	špecifikácia	
16075	R 003	10

ČEPEL NÁHRADNÁ

10x



ČEPEL NÁHRADNÁ

10x



ČEPEL NÁHRADNÁ

5x



Č.p.	špecifikácia	
16071	R 001	60

Č.p.	špecifikácia	
16073	R 002	60

Č.p.	špecifikácia	
16084	18 mm	1

ČEPEL NÁHRADNÁ

5x



ČEPEL NÁHRADNÁ



ČEPEL NÁHRADNÁ NA ŠKRABKU



Č.p.	špecifikácia	
16083	18 mm	1

· pre 34315

Č.p.	špecifikácia	
34316		1

· pre 16052

Č.p.	špecifikácia	
16070	100 mm	25

NŮŽ LOVECKÝ

FESTA

INOX

TEFLON

NYLON



- Nylonová rukoväť
- Čepel s teflónovým povrchom
- Puzdro s poistkou a klipom



Č.p.	špecifikácia
16234	21 10 cm

1

NŮŽ LOVECKÝ

FESTA

INOX

TEFLON



Č.p.	špecifikácia
16229	23 10 cm

12

DLÁTO STOLÁRSKE MULTIFUNKČNÉ

FESTA

INOX



- zosilnená čepel'

Č.p.	špecifikácia
16231	20 8 cm



12

NŮŽ TECHNICKÝ

INOX



- zosilnená čepel'

Č.p.	špecifikácia
16230	21 10 cm

12

NŮŽ

INOX



Č.p.	špecifikácia
16022	16 6,5 cm

100

NŮŽ ZAHNUTÝ NA PODLAHOVINY

FESTA

Č.p.	špecifikácia
16225	20 8,5 cm

12

NŮŽ ELEKTRIKÁRSKY

FESTA

INOX



- zosilnená čepel'

Č.p.	špecifikácia
16212	15 3,2 cm

12

NŮŽ ODIZOLOVACÍ

FESTA

Č.p.	špecifikácia
16201	Ø 8 - 27 mm

12

NÔŽ ELEKTRIKÁRSKY

INOX

FESTA



Č.p. špecifikácia
16211 20 | 8,5 cm

10

NÔŽ ELEKTRIKÁRSKY

INOX

FESTA



Č.p. špecifikácia
16210 20,5 | 9 cm

10

NÔŽ OČKOVACÍ

INOX

FESTA



Č.p. špecifikácia
16219 19 | 11 cm

24

NÔŽ VRÚBĽOVACÍ

INOX

FESTA



Č.p. špecifikácia
16218 18,5 | 10,5 cm

24

NÔŽ ŠTEPÁRSKY

INOX

FESTA



Č.p. špecifikácia
16220 18,5 | 11 cm

24

NÔŽ ZATVÁRACÍ

INOX

FESTA



Č.p. špecifikácia
16235 17,5 | 8,5 cm

24

NÔŽ ZATVÁRACÍ

INOX

FESTA



Č.p. špecifikácia
16221 21 | 12 cm

24

NÔŽ ZATVÁRACÍ

INOX

FESTA



Č.p. špecifikácia
16236 22,5 | 11 cm

24

NŮŽ ZATVÁRACÍ

FESTA



Č.p. 16209
špecifikácia 14,5 | 5,5 cm



1

NŮŽ ZATVÁRACÍ

FESTA

INOX



Č.p. 16222
špecifikácia 20 | 12 cm



24

NŮŽ ZATVÁRACÍ

FESTA

INOX

ALU



Č.p. 16223
špecifikácia 18,5 | 10,5 cm



24

NŮŽ ZATVÁRACÍ MULTIFUNKČNÝ

FESTA

INOX



· 10 funkcií

Č.p. 16226
špecifikácia 17,5 | 7 cm



24

NŮŽ ZATVÁRACÍ MULTIFUNKČNÝ

FESTA

INOX



· 5 funkcií

Č.p. 16228
špecifikácia 27 | 10,5 cm



24

NŮŽ ZATVÁRACÍ LOVECKÝ

· 3 funkciie

Č.p. 16227
špecifikácia 20,5 | 10 cm



24

NŮŽ ZATVÁRACÍ MULTIFUNKČNÝ

INOX



· 7 funkcií

Č.p. 16224
špecifikácia 17,5 | 7 cm



24

KLIESTE MULTIFUNKČNÉ

CrV

FESTA®



- 9 funkcií
- púzdro

Č.p. špecifikácia

16232

12

NŮŽ NA MINERÁLNĽU VATU

FESTA®

NŮŽ NA IZOLÁCIE

FESTA®



Č.p. špecifikácia

16198 44,5 | 33 cm

12



- na minerálnu vatú, polystyrén

Č.p. špecifikácia

16199 48 | 35 cm

10

MAČETA

TEFLON

FESTA®

MAČETA

TEFLON

FESTA®



Č.p. špecifikácia

45069 440 mm

6

Č.p. špecifikácia

44950 490 mm

4

MAČETA NEREZ

INOX

MAČETA



Č.p. špecifikácia

45083 430 mm

12

45084 600 mm

6

Č.p. špecifikácia

45081 510 mm



45082 710 mm

36

- rukoväť vyrobená z jaseňového dreva

SADA SKALPELOV

23x



Č.p. špecifikácia

16282

24

SADA SKALPELOV

13x



Č.p. špecifikácia

16281

10

BRÚSNY KAMEŇ OVÁLNY



Č.p. špecifikácia

45370

250 x 33 x 18 mm



20

BRÚSNY KAMEŇ



Č.p. špecifikácia

45045

150 x 50 x 30 mm



1

OSLA NA KOSU



Č.p. špecifikácia

45046

205 x 15 mm



100

BRÚSKA NA NOŽE A NOŽNICE



Č.p. špecifikácia

16991



20

BRÚSKA NA NOŽE A NOŽNICE



Č.p. špecifikácia

16990

Ø 50 mm



1

BRÚSKA NA NOŽE A NOŽNICE



Č.p. špecifikácia

45048



20

BRÚSKA NA NOŽE A NOŽNICE 6 V 1



Č.p. špecifikácia

45068



10

POLYFÚZNÁ ZVÁRAČKA PLASTOVÝCH RÚR

FESTA®



TEFLON

- Napätie / frekvencia
- príkon
- teplota
- nástavce
- váha

230 V / 50 Hz
750 / 1500 W
0-300 C°
Ø 20,25,32,40,50,63 mm
1,6 kg



• súčasť balenia: meter, vodováha, skrutkovač, inbus kľúč, nožnice na rúrky, 6x zvrácači nástavec, stojan, plechový kufor

č.p.

17182



1

HROTOVÁ POLYFÚZNÁ ZVÁRAČKA PLASTOVÝCH RÚR

FESTA®



TEFLON

- Napätie / frekvencia
- príkon
- teplota
- nástavce
- váha

230 V / 50 Hz
800 / 1000 W
0-300 C°
Ø 16, 20, 25, 32 mm
1 kg



• súčasť balenia: inbus, 4x zvrácači nástavec, stojan, plechový kufor

č.p.

17183



1



FESTA®

KLIEŠTE NA PVC RÚRKY

FESTA®

Ø max.
42 mm



Č.p. špecifikácia

17027		6
16315	náhradná čepeľ	1

ČEPEĽ NÁHRADNÁ PRE KLIEŠTE



· pre kliešte 17027

Č.p. špecifikácia

16315		1
-------	--	---

KLIEŠTE NA PVC RÚRKY

Ø max.
42 mm



Č.p. špecifikácia

17026		6
-------	--	---

NOŽNICE NA PVC LIŠTY A RÚRKY

FESTA®

Ø 16
mm

Ø 19
mm

Ø 25
mm

5x



· lišty, rúrky, profily

Č.p. špecifikácia

17050		8
-------	--	---

REZAČ TENKOSTENNÝCH TRUBIEK

FESTA®

ID 3-32
mm

Č.p.	špecifikácia	
16301		10
16311	Náhradné koliesko	1

REZAČ TENKOSTENNÝCH TRUBIEK

FESTA®

ID 6-64
mm

Č.p.	špecifikácia	
16304		6
16312	Náhradné koliesko	1

REZAČ TENKOSTENNÝCH TRUBIEK

ID 3-32
mm

Č.p.	špecifikácia	
16303		10
16311	Náhradné koliesko	1

REZAČ TENKOSTENNÝCH TRUBIEK

ID 3-32
mm

Č.p.	špecifikácia	
16300		10
16310	Náhradné koliesko	1

KOLIESKO NÁHRADNÉ PRE REZAČE PVC TRUBIEK

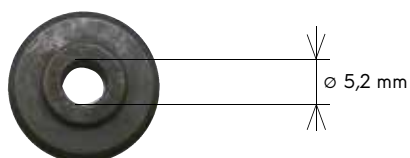

Č.p.	špecifikácia	
16310	Ø 17,5 mm x 6 m pre 16300	1
16311	Ø 18,0 mm x 4,5 mm pre 16303, 16301	1
16312	Ø 27,5 mm x 6 mm pre 16304	1

ODIHLOVAČ NA RÚRKY

ID 6-32
mm

Č.p.	špecifikácia	
16320		1

FRÉZA ODIHLOVACIA, RUČNÉ HSS

1/4"

HSS

4x



Č.p.	špecifikácia	
20360		10

ODIHLOVAČ



Č.p.	špecifikácia	
20361		1

REZAČKA POLYSTYRÉNU STRUNOVÁ

FESTA®

- Napätie / frekvencia: 230 V/50 Hz
- Príkon: 160 W
- Dĺžka rezu: 137 cm
- Výška rezu: 30 cm
- Krytie: IP44
- Uhol rezu: 0° - 90°

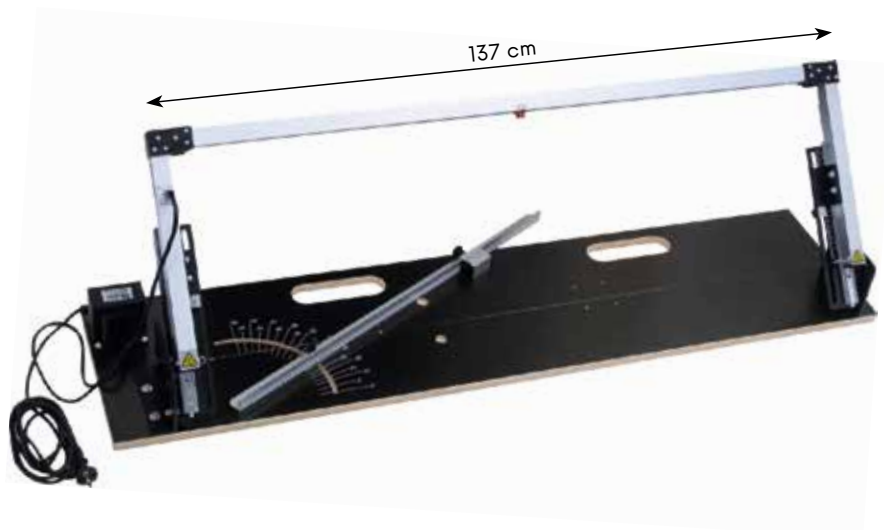
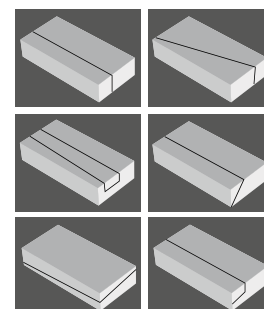

- vybavenie: Ni-Cr rezací drôt, čistiaca mosadzná kefa, inbus



Č.p.	špecifikácia	
35345	Rezačka polystyrénu 1500 x 450 mm	1
35346	Náhradná rezná struna Ni-Cr	1
35347	náhradný zdroj	1

REZAČKA POLYSTYRÉNU STRUNOVÁ

FESTA®

- Napätie / frekvencia: 230 V/50 Hz
- Príkon: 160 W
- Dĺžka rezu: 120 cm
- Výška rezu: 30 cm
- Krytie: IP44
- Uhol rezu: 0° - 90°

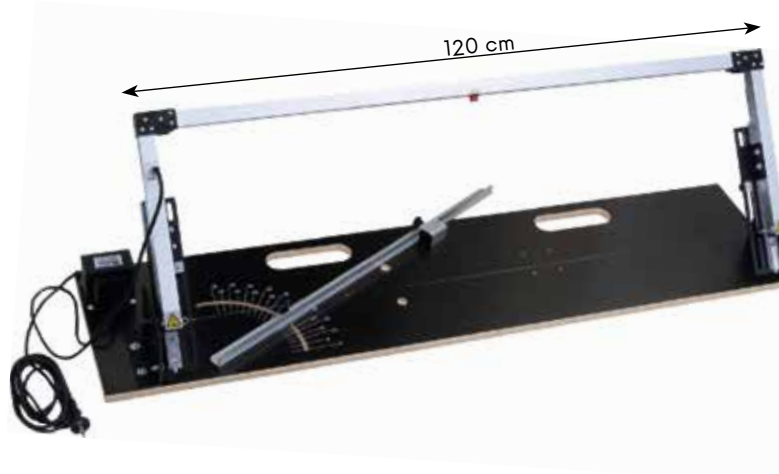
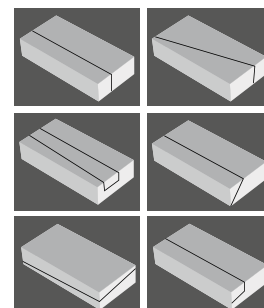

- vybavenie: Ni-Cr rezací drôt, čistiaca mosadzná kefa, inbus



Č.p.	špecifikácia	
35330	Rezačka polystyrénu 1350 x 450 mm	1
35331	Náhradná rezná struna Ni-Cr	1
35347	náhradný zdroj	1

REZAČKA POLYSTYRÉNU AKUMULÁTOROVÁ

FESTA®



- batérie
- výkon
- teplota
- dĺžka čepele

36 V, 1,5Ah Li-ion
180 W
max 350 C°
20 cm



- Vybavenie: 2 ks batérie, nabíjačka, čepeľ, čistiaca mosadzná kefa, inbus

Č.p. špecifikácia

35323



1

REZAČKA POLYSTYRÉNU ELEKTRICKÁ

FESTA®

VODIACA LIŠTA PRE REZAČKU POLYSTYRÉNU



- Napätie / frekvencia
- príkon
- teplota
- dĺžka čepele
- dĺžka privodného kábla

230 V/50 Hz
250 W
50-600 C°
25 cm
3 m



- pre 35323, 35326



- Vybavenie: čistiaca mosadzná kefa, inbus, nôž 25 a 30 cm, kufor

Č.p. špecifikácia

35326	Elektrická rezačka polystyrénu	1
35328	Náhr. nôž do rezačky polystyrénu 14 cm	1
35329	Náhr. nôž do rezačky polystyrénu 25 cm	1



Č.p.	špecifikácia	
35327	vodiaca lišta	1
35335	Náhradný nôž - 30 cm	1



1

REZAČKA POLYSTYRÉNU ELEKTRICKÁ



- regulácia teploty

Č.p. špecifikácia

35325 220 W



1

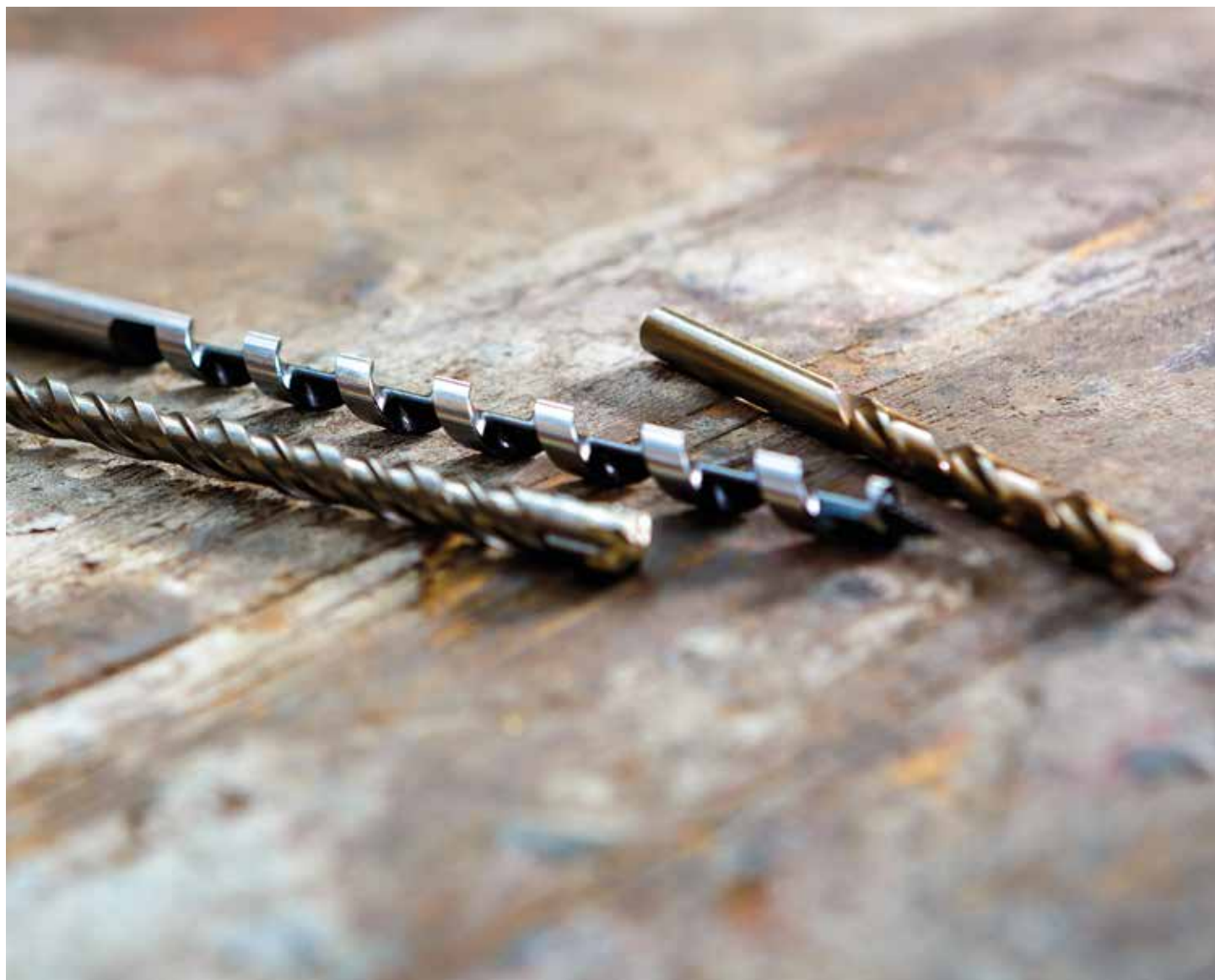

VRTÁK VYBRÚSENÝ DO KOVU HSS-G COBALT 5%

FESTA

Co 5%, W 6%
Mo 5%, Cr 4%, V 4%

HSS



DIN
338

135°



INOX  1400 MPa



Č.p.	špecifikácia		Č.p.	špecifikácia		Č.p.	špecifikácia	
22510	Ø 1,00 mm	1	22548	Ø 4,80 mm	1	22590	Ø 9,00 mm	1
22515	Ø 1,50 mm	1	22550	Ø 5,00 mm	1	22595	Ø 9,50 mm	1
22520	Ø 2,00 mm	1	22555	Ø 5,50 mm	1	22600	Ø 10,00 mm	1
22525	Ø 2,50 mm	1	22560	Ø 6,00 mm	1	22602	Ø 10,20 mm	1
22530	Ø 3,00 mm	1	22565	Ø 6,50 mm	1	22605	Ø 10,50 mm	1
22532	Ø 3,20 mm	1	22568	Ø 6,80 mm	1	22610	Ø 11,00 mm	1
22535	Ø 3,50 mm	1	22570	Ø 7,00 mm	1	22615	Ø 11,50 mm	1
22540	Ø 4,00 mm	1	22575	Ø 7,50 mm	1	22620	Ø 12,00 mm	1
22542	Ø 4,20 mm	1	22580	Ø 8,00 mm	1	22625	Ø 12,50 mm	1
22545	Ø 4,50 mm	1	22585	Ø 8,50 mm	1	22630	Ø 13,00 mm	1

VRTÁK VYBRÚSENÝ DO KOVU HSS-G W 9 %

FESTA®

W 9%, Mo 3%
Cr 4%, V 1%

HSS

DIN
338

MOQ



INOX 1100 MPa

Č.p.	špecifikácia		Č.p.	špecifikácia	
19530	Ø 1,00 mm	10	19556	Ø 3,60 mm	10
19531	Ø 1,10 mm	10	19557	Ø 3,70 mm	10
19532	Ø 1,20 mm	10	19558	Ø 3,80 mm	10
19533	Ø 1,30 mm	10	19559	Ø 3,90 mm	10
19534	Ø 1,40 mm	10	19560	Ø 4,00 mm	10
19535	Ø 1,50 mm	10	19561	Ø 4,10 mm	10
19536	Ø 1,60 mm	10	19562	Ø 4,20 mm	10
19537	Ø 1,70 mm	10	19563	Ø 4,30 mm	10
19538	Ø 1,80 mm	10	19564	Ø 4,40 mm	10
19539	Ø 1,90 mm	10	19565	Ø 4,50 mm	10
19540	Ø 2,00 mm	10	19566	Ø 4,60 mm	10
19541	Ø 2,10 mm	10	19567	Ø 4,70 mm	10
19542	Ø 2,20 mm	10	19568	Ø 4,80 mm	10
19543	Ø 2,30 mm	10	19569	Ø 4,90 mm	5
19544	Ø 2,40 mm	10	19570	Ø 5,00 mm	5
19545	Ø 2,50 mm	10	19571	Ø 5,10 mm	5
19546	Ø 2,60 mm	10	19572	Ø 5,20 mm	5
19547	Ø 2,70 mm	10	19573	Ø 5,30 mm	5
19548	Ø 2,80 mm	10	19574	Ø 5,40 mm	5
19549	Ø 2,90 mm	10	19575	Ø 5,50 mm	5
19550	Ø 3,00 mm	10	19576	Ø 5,60 mm	5
19551	Ø 3,10 mm	10	19577	Ø 5,70 mm	5
19552	Ø 3,20 mm	10	19578	Ø 5,80 mm	5
19553	Ø 3,30 mm	10	19579	Ø 5,90 mm	5
19554	Ø 3,40 mm	10	19580	Ø 6,00 mm	5
19555	Ø 3,50 mm	10	19581	Ø 6,10 mm	5

Č.p.	špecifikácia		Č.p.	špecifikácia	
19582	Ø 6,20 mm	5	19624	Ø 10,40 mm	3
19583	Ø 6,30 mm	5	19625	Ø 10,50 mm	3
19584	Ø 6,40 mm	5	19626	Ø 10,60 mm	3
19585	Ø 6,50 mm	5	19627	Ø 10,70 mm	3
19586	Ø 6,60 mm	5	19628	Ø 10,80 mm	3
19587	Ø 6,70 mm	5	19629	Ø 10,90 mm	3
19588	Ø 6,80 mm	5	19630	Ø 11,00 mm	3
19589	Ø 6,90 mm	5	19631	Ø 11,10 mm	3
19590	Ø 7,00 mm	5	19632	Ø 11,20 mm	3
19591	Ø 7,10 mm	5	19633	Ø 11,30 mm	3
19592	Ø 7,20 mm	5	19634	Ø 11,40 mm	3
19593	Ø 7,30 mm	5	19635	Ø 11,50 mm	3
19594	Ø 7,40 mm	5	19636	Ø 11,60 mm	3
19595	Ø 7,50 mm	5	19637	Ø 11,70 mm	3
19596	Ø 7,60 mm	5	19638	Ø 11,80 mm	3
19597	Ø 7,70 mm	5	19639	Ø 11,90 mm	3
19598	Ø 7,80 mm	5	19640	Ø 12,00 mm	3
19599	Ø 7,90 mm	5	19641	Ø 12,10 mm	3
19600	Ø 8,00 mm	5	19642	Ø 12,20 mm	3
19601	Ø 8,10 mm	5	19643	Ø 12,30 mm	3
19602	Ø 8,20 mm	5	19644	Ø 12,40 mm	3
19603	Ø 8,30 mm	5	19645	Ø 12,50 mm	3
19604	Ø 8,40 mm	5	19646	Ø 12,60 mm	1
19605	Ø 8,50 mm	5	19647	Ø 12,70 mm	1
19606	Ø 8,60 mm	5	19648	Ø 12,80 mm	1
19607	Ø 8,70 mm	5	19649	Ø 12,90 mm	1
19608	Ø 8,80 mm	5	19650	Ø 13,00 mm	1
19609	Ø 8,90 mm	5	19651	Ø 13,20 mm R13	1
19610	Ø 9,00 mm	5	19652	Ø 13,50 mm R13	1
19611	Ø 9,10 mm	5	19653	Ø 14,00 mm R13	1
19612	Ø 9,20 mm	5	19654	Ø 14,50 mm R13	1
19613	Ø 9,30 mm	5	19655	Ø 15,00 mm R13	1
19614	Ø 9,40 mm	5	19656	Ø 15,50 mm R13	1
19615	Ø 9,50 mm	3	19657	Ø 16,00 mm R13	1
19616	Ø 9,60 mm	3	19658	Ø 16,50 mm R13	1
19617	Ø 9,70 mm	3	19659	Ø 17,00 mm R13	1
19618	Ø 9,80 mm	3	19660	Ø 17,50 mm R13	1
19619	Ø 9,90 mm	3	19661	Ø 18,00 mm R13	1
19620	Ø 10,00 mm	3	19662	Ø 18,50 mm R13	1
19621	Ø 10,10 mm	3	19663	Ø 19,00 mm R13	1
19622	Ø 10,20 mm	3	19664	Ø 19,50 mm R13	1
19623	Ø 10,30 mm	3	19665	Ø 20,00 mm R13	1

BOX S VYBRÚSENÝMI VRTÁKMI DO KOVU HSS-G W 9 %

FESTA®

W 9%, Mo 3%
Cr 4%, V 1%

HSS

DIN
338

INOX 1100 MPa

Č.p. špecifikácia

19669



1

Č.p.	obsah sady	Č.p.	obsah sady
19530	Ø 1,00 mm 20x	19585	Ø 6,50 mm 15x
19535	Ø 1,50 mm 20x	19590	Ø 7,00 mm 15x
19540	Ø 2,00 mm 20x	19595	Ø 7,50 mm 15x
19545	Ø 2,50 mm 20x	19600	Ø 8,00 mm 15x
19550	Ø 3,00 mm 20x	19605	Ø 8,50 mm 15x
19552	Ø 3,20 mm 20x	19610	Ø 9,00 mm 15x
19555	Ø 3,50 mm 20x	19615	Ø 9,50 mm 15x
19558	Ø 3,80 mm 20x	19620	Ø 10,00 mm 15x
19560	Ø 4,00 mm 30x	19625	Ø 10,50 mm 6x
19562	Ø 4,20 mm 20x	19630	Ø 11,00 mm 6x
19565	Ø 4,50 mm 20x	19635	Ø 11,50 mm 6x
19568	Ø 4,80 mm 20x	19640	Ø 12,00 mm 6x
19570	Ø 5,00 mm 15x	19645	Ø 12,50 mm 6x
19575	Ø 5,50 mm 15x	19650	Ø 13,00 mm 6x
19580	Ø 6,00 mm 30x		

VRTÁK VYBRÚSENÝ DO KOVU

FESTA

 W 4%, Mo 3%
 Cr 4%, V 1%

HSS
**DIN
338**

MOQ

Č.p.	špecifikácia		Č.p.	špecifikácia		Č.p.	špecifikácia	
19670	Ø 0,6 mm	10	19694	Ø 3,1 mm	10	19760	Ø 9,7 mm	5
19671	Ø 0,8 mm	10	19695	Ø 3,2 mm	10	19761	Ø 9,8 mm	5
19672	Ø 0,9 mm	10	19696	Ø 3,3 mm	10	19762	Ø 9,9 mm	5
19673	Ø 1,0 mm	10	19697	Ø 3,4 mm	10	19763	Ø 10,0 mm	5
19674	Ø 1,1 mm	10	19698	Ø 3,5 mm	10	19764	Ø 10,1 mm	5
19675	Ø 1,2 mm	10	19699	Ø 3,6 mm	10	19765	Ø 10,2 mm	5
19676	Ø 1,3 mm	10	19700	Ø 3,7 mm	10	19766	Ø 10,3 mm	5
19677	Ø 1,4 mm	10	19701	Ø 3,8 mm	10	19767	Ø 10,4 mm	5
19678	Ø 1,5 mm	10	19702	Ø 3,9 mm	10	19768	Ø 10,5 mm	5
19679	Ø 1,6 mm	10	19703	Ø 4,0 mm	10	19769	Ø 10,6 mm	5
19680	Ø 1,7 mm	10	19704	Ø 4,1 mm	10	19770	Ø 10,7 mm	5
19681	Ø 1,8 mm	10	19705	Ø 4,2 mm	10	19771	Ø 10,8 mm	5
19682	Ø 1,9 mm	10	19706	Ø 4,3 mm	10	19772	Ø 11,0 mm	5
19683	Ø 2,0 mm	10	19707	Ø 4,4 mm	10	19773	Ø 11,2 mm	5
19684	Ø 2,1 mm	10	19708	Ø 4,5 mm	10	19774	Ø 11,3 mm	5
19685	Ø 2,2 mm	10	19709	Ø 4,6 mm	10	19775	Ø 11,4 mm	5
19686	Ø 2,3 mm	10	19710	Ø 4,7 mm	10	19776	Ø 11,5 mm	5
19687	Ø 2,4 mm	10	19711	Ø 4,8 mm	10	19777	Ø 11,6 mm	5
19688	Ø 2,5 mm	10	19712	Ø 4,9 mm	10	19778	Ø 11,7 mm	5
19689	Ø 2,6 mm	10	19713	Ø 5,0 mm	10	19779	Ø 11,8 mm	5
19690	Ø 2,7 mm	10	19714	Ø 5,1 mm	10	19780	Ø 11,9 mm	5
19691	Ø 2,8 mm	10	19715	Ø 5,2 mm	10	19781	Ø 12,0 mm	5
19692	Ø 2,9 mm	10	19716	Ø 5,3 mm	10	19782	Ø 12,2 mm	5
19693	Ø 3,0 mm	10	19717	Ø 5,4 mm	10	19783	Ø 12,5 mm	5
						19784	Ø 12,8 mm	5
						19785	Ø 12,9 mm	5
						19786	Ø 13,0 mm	5
						19787	Ø 13,2 mm R13	5
						19788	Ø 13,5 mm R13	5
						19789	Ø 14,0 mm R13	5
						19790	Ø 14,5 mm R13	5
						19791	Ø 15,0 mm R13	5
						19792	Ø 15,5 mm R13	5
						19793	Ø 16,0 mm R13	5
						19794	Ø 16,5 mm R13	5
						19795	Ø 17,0 mm R13	5
						19796	Ø 17,5 mm R13	5
						19797	Ø 18,0 mm R13	5
						19798	Ø 18,5 mm R13	5
						19799	Ø 19,0 mm R13	5
						19800	Ø 19,5 mm R13	5
						19801	Ø 20,0 mm R13	5

BOX S VYBRÚSENÝMI VRTÁKMI DO KOVU HSS 4341

FESTA

 W 4%, Mo 3%
 Cr 4%, V 1%

HSS
**DIN
338**

Č.p. špecifikácia

19802

Č.p.	obsah sady	Č.p.	obsah sady
19673	Ø 1,00 mm 20x	19728	Ø 6,50 mm 20x
19678	Ø 1,50 mm 20x	19733	Ø 7,00 mm 10x
19683	Ø 2,00 mm 20x	19738	Ø 7,50 mm 10x
19688	Ø 2,50 mm 20x	19743	Ø 8,00 mm 10x
19693	Ø 3,00 mm 30x	19748	Ø 8,50 mm 10x
19695	Ø 3,20 mm 30x	19753	Ø 9,00 mm 10x
19698	Ø 3,50 mm 30x	19758	Ø 9,50 mm 10x
19701	Ø 3,80 mm 30x	19763	Ø 10,00 mm 10x
19703	Ø 4,00 mm 30x	19768	Ø 10,50 mm 10x
19705	Ø 4,20 mm 30x	19772	Ø 11,00 mm 10x
19708	Ø 4,50 mm 30x	19776	Ø 11,50 mm 10x
19711	Ø 4,80 mm 30x	19781	Ø 12,00 mm 10x
19713	Ø 5,00 mm 20x	19783	Ø 12,50 mm 10x
19718	Ø 5,50 mm 20x	19786	Ø 13,00 mm 5x
19723	Ø 6,00 mm 20x		

1

VRTÁK DO KOVU HSS PREDĽŽENÝ

FESTA

W 4%, Mo 3%
Cr 4%, V 1%

HSS

DIN
338

MOQ

Č.p.	špecifikácia	10	Č.p.	špecifikácia	10
20220	Ø 2,0 mm x 85 mm	10	20255	Ø 5,5 mm x 139 mm	10
20225	Ø 2,5 mm x 95 mm	10	20260	Ø 6,0 mm x 139 mm	10
20230	Ø 3,0 mm x 100 mm	10	20270	Ø 7,0 mm x 156 mm	10
20235	Ø 3,5 mm x 110 mm	10	20280	Ø 8,0 mm x 165 mm	10
20240	Ø 4,0 mm x 119 mm	10	20290	Ø 9,0 mm x 175 mm	10
20245	Ø 4,5 mm x 126 mm	10	20296	Ø 10,0 mm x 184 mm	10
20250	Ø 5,0 mm x 132 mm	10			

VRTÁK DO KOVU HSS TIN

TiN

HSS

DIN
338

titánový povrch pre zvýšenie výkonu a životnosti

Č.p.	špecifikácia	1	Č.p.	špecifikácia	1	Č.p.	špecifikácia	1
20400	Ø 1,0 mm	1	20411	Ø 4,8 mm	1	20422	Ø 9,5 mm	1
20401	Ø 1,5 mm	1	20412	Ø 5,0 mm	1	20423	Ø 10,0 mm	1
20402	Ø 2,0 mm	1	20413	Ø 5,5 mm	1	20424	Ø 10,2 mm	1
20403	Ø 2,5 mm	1	20414	Ø 6,0 mm	1	20425	Ø 10,5 mm	1
20404	Ø 3,0 mm	1	20415	Ø 6,5 mm	1	20426	Ø 11,0 mm	1
20405	Ø 3,2 mm	1	20416	Ø 6,8 mm	1	20427	Ø 11,5 mm	1
20406	Ø 3,5 mm	1	20417	Ø 7,0 mm	1	20428	Ø 12,0 mm	1
20407	Ø 3,8 mm	1	20418	Ø 7,5 mm	1	20429	Ø 12,5 mm	1
20408	Ø 4,0 mm	1	20419	Ø 8,0 mm	1	20430	Ø 13,0 mm	1
20409	Ø 4,2 mm	1	20420	Ø 8,5 mm	1			
20410	Ø 4,5 mm	1	20421	Ø 9,0 mm	1			

VRTÁK DO KOVU HSS

HSS

DIN
338

MOQ

Č.p.	špecifikácia	10
19841	Ø 4,1 mm 5 ks	10
19842	Ø 4,2 mm 5 ks	10
19845	Ø 4,5 mm 5 ks	10
19885	Ø 8,5 mm 1 ks	10
19895	Ø 9,5 mm 1 ks	10

VRTÁKY VYBRÚSENÉ DO KOVU

W 9%, Mo 3%
Cr 4%, V 1%

FESTA

HSS

DIN
338

13x



Č.p. špecifikácia
20333 Ø 1,5 - 6,5 mm

1

VRTÁKY VYBRÚSENÉ DO KOVU

W 9%, Mo 3%
Cr 4%, V 1%

FESTA

HSS

DIN
338

19x



Č.p. špecifikácia
20334 Ø 1,0 - 10,0 mm

1

VRTÁKY VYBRÚSENÉ DO KOVU

W 9%, Mo 3%
Cr 4%, V 1%

FESTA

HSS

DIN
338

25x

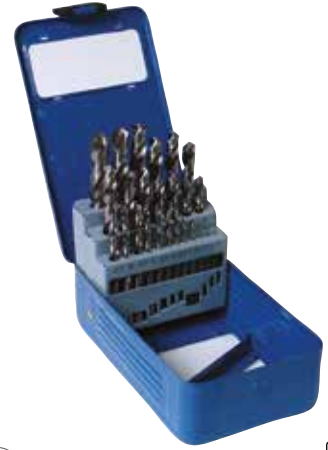

Č.p. špecifikácia
20335 Ø 1,0 - 13,0 mm

1

VRTÁKY DO KOVU

FESTA

W 4%, Mo 3%
Cr 4%, V 1%

HSS

DIN
338

13x



Č.p. špecifikácia
20336 Ø 1,5 - 6,5 mm

1

VRTÁKY DO KOVU

FESTA

W 4%, Mo 3%
Cr 4%, V 1%

HSS

DIN
338

19x



Č.p. špecifikácia
20337 Ø 1,0 - 10,0 mm

1

VRTÁKY DO KOVU

FESTA

W 4%, Mo 3%
Cr 4%, V 1%

HSS

DIN
338

25x



Č.p. špecifikácia
20338 Ø 1,0 - 13,0 mm

1

SADA VRTÁKOV

TiN

9x



Č.p. špecifikácia
20317 Ø 5, 6, 8 mm

FESTA

VRTÁKY SO ŠEŠŤHRANNOU STOPKOU

FESTA

1/4"

HSS

7x



Č.p. špecifikácia
20316 Ø 1,5-2-3-4-5-5,5-6 mm

20



10

VRTÁKY DO KOVU

HSS

DIN
338

19x



Č.p. špecifikácia
20305 Ø 1,0 - 10,0 mm



20

VRTÁKY DO KOVU

HSS

DIN
338

25x



Č.p. špecifikácia
20311 Ø 1,0 - 13,0 mm



10

VRTÁKY DO KOVU

HSS

DIN
338

13x



Č.p. špecifikácia
20300 Ø 1,5 - 6,5 mm



10

VRTÁKY DO KOVU

HSS

DIN
338

19x



Č.p. špecifikácia
20310 Ø 1 - 13 mm



10

VRTÁKY DO KOVU

HSS

DIN
338

19x



Č.p. špecifikácia
20315 Ø 1 - 10 mm



5

VRTÁKY DO KOVU

TiN

HSS

DIN
338

19x



Č.p. špecifikácia
20320 Ø 1 - 10 x 0,5 mm



5

VRTÁKY DO KOVU

HSS

DIN
338

19x



Č.p. špecifikácia
20321 Ø 1 - 10 x 0,5 mm



5

OSTRIČ VRTÁKOV



Č.p. špecifikácia
20380 pre Ø 3,5 - 10 mm

20

VRTÁK STUPŇOVÝ TiN

FESTA
TiN
HSS



Č.p.	špecifikácia	
20489	Ø 4 - 12 mm 8 stupňů	20
20490	Ø 4 - 20 mm 9 stupňů	10
20491	Ø 5 - 35 mm 13 stupňů	10
20492	Ø 7 - 40,5 mm 13 stupňů	5

VRTÁK STUPŇOVÝ HSS

HSS

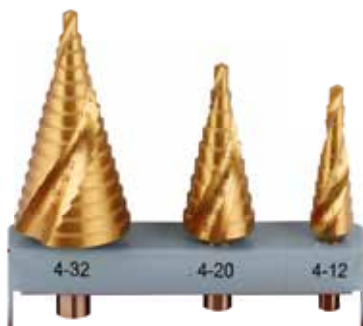

Č.p.	špecifikácia	
20487	Ø 4 - 20 mm 9 stupňů	10
20488	Ø 5 - 35 mm 13 stupňů	10
20494	Ø 4 - 32 mm 15 stupňů	10
20493	Ø 7 - 40,5 mm 13 stupňů	1

SADA STUPŇOVITÝCH VRTÁKOV

FESTA
TiN
HSS
3x

Č.p.	špecifikácia	
20495	Ø 4 - 12, 4 - 20, 4 - 32 mm	1

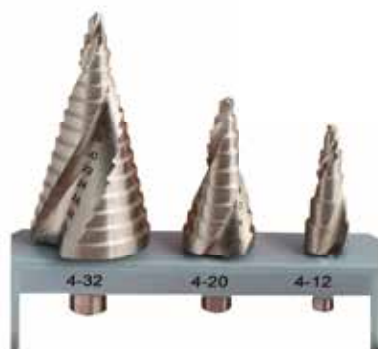
SADA STUPŇOVITÝCH VRTÁKOV

HSS
3x

Č.p.	špecifikácia	
20496	Ø 4 - 12, 4 - 20, 4 - 32 mm	1

VYKRUŽOVACIE KORUNKY HSS BI-METAL

FESTA®

NEW

HSS



Č.p.	špecifikácia	
24419	Ø 19 mm	1
24420	Ø 20 mm	1
24422	Ø 22 mm	1
24425	Ø 25 mm	1
24429	Ø 29 mm	1
24432	Ø 32 mm	1
24435	Ø 35 mm	1
24437	Ø 37 mm	1
24444	Ø 44 mm	1
24451	Ø 51 mm	1
24457	Ø 57 mm	1
24464	Ø 64 mm	1
24476	Ø 76 mm	1
24483	Ø 83 mm	1

UNÁŠAČ PRE VYKRUŽOVACIE KORUNKY

FESTA®

NEW

14 - 30 mm



Č.p.	špecifikácia	
24410		1

UNÁŠAČ PRE VYKRUŽOVACIE KORUNKY

FESTA®

NEW

32 - 152 mm



Č.p.	špecifikácia	
24411		1

VYKRUŽOVACIE KORUNKY BI-METAL - SADA

FESTA®

HSS

9x



Č.p.	špecifikácia	
24750	Ø 19, 22, 29, 38, 44, 57 mm	10



VYKRUŽOVACIE KORUNKY BI-METAL - SADA

FESTA®

HSS

13x



Č.p.	špecifikácia	
24751	Ø 19, 22, 29, 35, 38, 44, 51, 57, 64 mm	10



VYŤAHOVÁK ZALOMENÝCH SKRUTIEK - SADA

8x

FESTA

- Ø 4 mm
- Ø 4,5 mm
- Ø 6,5 mm
- Ø 7,5 mm
- Ø 11 mm
- Ø 15 mm
- Ø 19 mm
- Ø 24 mm



Č.p. špecifikácia

20387



5

VYŤAHOVÁK ZALOMENÝCH SKRUTIEK - SADA

5x

FESTA

- Ø 4 mm
- Ø 4,5 mm
- Ø 6 mm
- Ø 7,5 mm
- Ø 11 mm



Č.p. špecifikácia

20386



10

VYŤAHOVÁK ZALOMENÝCH SKRUTIEK - SADA

5x

- Ø 4 mm
- Ø 4,5 mm
- Ø 6 mm
- Ø 7,5 mm
- Ø 11 mm



Č.p. špecifikácia

20385



10

DRŽIAK NA ZÁVITOVÉ OČKÁ

DIN 225



Č.p. špecifikácia

20396

25 x 9 mm



10

FESTA

VRATIDLO RAČŇOVÉ NA ZÁVITNÍKY



VRATIDLO NASTAVITEĽNÉ

DIN 1814



Č.p. špecifikácia

20395

1 - 1/2, M3 - M12



10

Č.p. špecifikácia

20397

M3 - M8



10

ZÁVITNÍKY A ZÁVITOVÉ OČKÁ - SADA

32x

FESTA



Č.p. špecifikácia

20391

M 3, 4, 5, 6, 8, 10, 12 mm



1

VRATIDLO NASTAVITEĽNÉ

21x

FESTA



Č.p. špecifikácia

20390

M 3, 4, 5, 6, 8, 10, 12 mm



1

VRTÁK PRÍKLEPOVÝ VIDIOVÝ

FESTA®

DIN
8039

· dvojbritový vrták

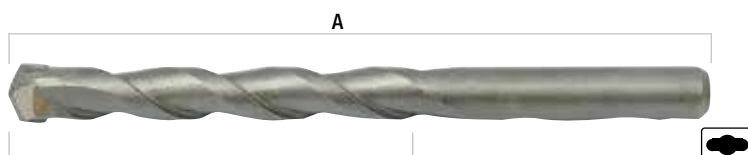

Č.p.	špecifikácia	A mm	B mm	
20673	Ø 3 mm	60	30	100
20674	Ø 4 mm	75	40	100
20675	Ø 5 mm	85	50	100
20676	Ø 6 mm	100	60	100
20677	Ø 6 mm	200	160	50
20685	Ø 6 mm	300	260	50

Č.p.	špecifikácia	A mm	B mm	
20678	Ø 8 mm	120	75	50
20686	Ø 8 mm	200	155	50
20687	Ø 8 mm	300	255	25
20688	Ø 8 mm	400	340	25
20680	Ø 10 mm	120	70	50
20690	Ø 10 mm	200	150	50
20691	Ø 10 mm	300	250	25
20692	Ø 10 mm	400	340	25
20682	Ø 12 mm	150	100	50
20694	Ø 12 mm	300	250	25
20696	Ø 12 mm	400	340	25
20684	Ø 14 mm	150	90	25
	redukce Ø 10 mm			
20697	Ø 14 mm	300	240	5
	redukce Ø 10 mm			
20698	Ø 14 mm	400	340	15
	redukce Ø 10 mm			

VRTÁK PRÍKLEPOVÝ VIDIOVÝ SDS+

FESTA®

SDS+

· dvojbritový vrták

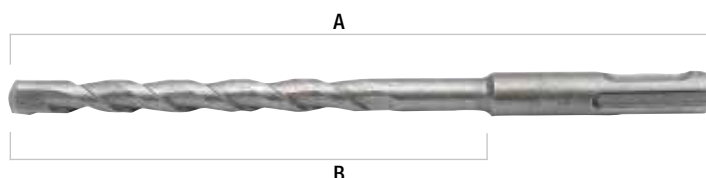

Č.p.	špecifikácia	A mm	B mm	
20855	Ø 14 mm	160	75	25

VRTÁK PRÍKLEPOVÝ VIDIOVÝ SDS+

FESTA®

SDS+

· štvorbřitový vrták so zvýšenou výkonnosťou a trvanlivosťou

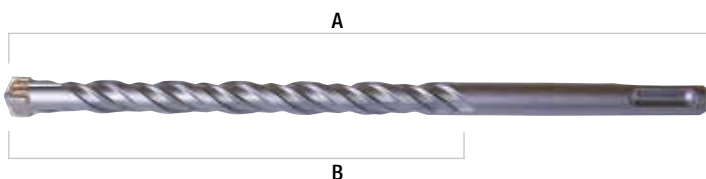

Č.p.	špecifikácia	A mm	B mm	
20748	Ø 6 mm	110	40	50
20749	Ø 6 mm	160	90	50
20750	Ø 6 mm	210	140	50
20751	Ø 6 mm	260	190	50
20861	Ø 6,5 mm	230	160	50
20862	Ø 6,5 mm	300	230	50
20752	Ø 8 mm	110	40	50
20753	Ø 8 mm	160	90	50
20754	Ø 8 mm	210	140	50
20755	Ø 8 mm	260	190	50
20825	Ø 8 mm	350	280	50
20756	Ø 10 mm	160	90	50
20757	Ø 10 mm	210	140	50
20758	Ø 10 mm	260	190	50
20759	Ø 10 mm	350	280	50
20760	Ø 10 mm	450	380	50

Č.p.	špecifikácia	A mm	B mm	
20761	Ø 10 mm	600	530	50
20762	Ø 10 mm	1000	930	50
20764	Ø 12 mm	160	80	50
20765	Ø 12 mm	210	130	50
20766	Ø 12 mm	260	180	50
20767	Ø 12 mm	350	270	50
20768	Ø 12 mm	460	380	50
20769	Ø 12 mm	600	520	25
20770	Ø 12 mm	1000	920	25
20771	Ø 14 mm	160	80	25
20772	Ø 14 mm	260	180	25
20773	Ø 14 mm	350	270	25
20774	Ø 14 mm	460	380	25
20775	Ø 14 mm	600	520	25
20776	Ø 14 mm	1000	920	30
20777	Ø 16 mm	160	80	25

Č.p.	špecifikácia	A mm	B mm	
20778	Ø 16 mm	210	130	25
20779	Ø 16 mm	260	180	25
20780	Ø 16 mm	350	270	25
20781	Ø 16 mm	460	380	25
20782	Ø 16 mm	600	520	30
20783	Ø 16 mm	1000	920	25
20784	Ø 18 mm	260	180	25
20785	Ø 18 mm	450	370	25
20786	Ø 18 mm	600	520	32
20787	Ø 18 mm	1000	920	20
20788	Ø 20 mm	450	370	20
20789	Ø 20 mm	600	520	20
20790	Ø 20 mm	800	720	25
20791	Ø 20 mm	1000	920	10
20792	Ø 22 mm	450	365	20
20793	Ø 22 mm	600	520	20
20794	Ø 22 mm	800	715	20
20795	Ø 22 mm	1000	920	10
20796	Ø 24 mm	450	365	10
20797	Ø 24 mm	600	520	20
20798	Ø 24 mm	800	715	10
20799	Ø 24 mm	1000	920	10
20870	Ø 26 mm	450	370	10
20871	Ø 26 mm	650	570	20
20872	Ø 26 mm	800	720	10
20873	Ø 26 mm	1000	920	10
20874	Ø 28 mm	450	365	10
20875	Ø 28 mm	600	565	20
20876	Ø 28 mm	800	715	10
20877	Ø 28 mm	1000	915	10
20878	Ø 30 mm	450	365	10
20879	Ø 30 mm	600	565	20
20880	Ø 30 mm	800	715	10
20881	Ø 30 mm	1000	915	10

VRTÁK PRÍKLEPOVÝ VIDIOVÝ SDS MAX

FESTA
SDS MAX

štvorbřitový vrták so zvýšenou výkonnosťou a trvanlivosťou

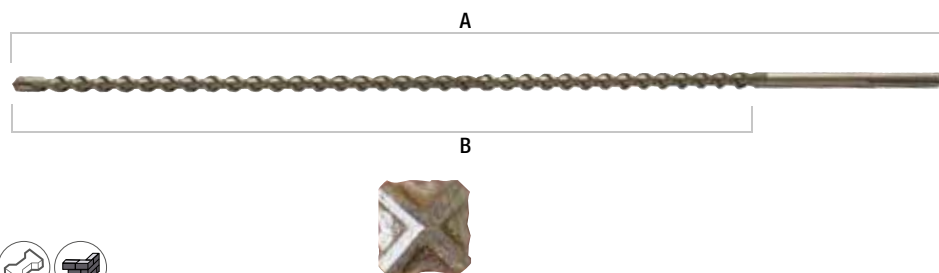

Č.p.	špecifikácia	A mm	B mm	
20510	Ø 18 mm	550	395	5
20520	Ø 18 mm	800	650	5
20511	Ø 20 mm	550	395	5
20521	Ø 20 mm	800	650	5
20512	Ø 22 mm	550	395	5
20522	Ø 22 mm	800	650	5
20513	Ø 24 mm	550	395	5
20523	Ø 24 mm	800	650	5
20514	Ø 28 mm	550	395	5
20524	Ø 28 mm	800	650	5
20515	Ø 30 mm	550	395	5
20525	Ø 30 mm	800	650	5
20516	Ø 40 mm	550	395	2
20526	Ø 40 mm	800	650	1



SADA VRTÁKOV DO MURIVA SDS +

SDS+
5x

Č.p.	špecifikácia	
20890	Ø 5, 6, 8, 10, 12 mm 160 mm	25

SADA VRTÁKOV DO MURIVA SDS +

SDS+
6x

Č.p.	špecifikácia	
20891	Ø 5, 6, 8 mm 110 mm Ø 8, 10, 12 mm 160 mm	25

STOJAN PREZENTAČNÝ



Č.p.	špecifikácia	
20999		1

SADA VRTÁKOV DO MURIVA

DIN 8039
6x

Č.p.	špecifikácia	
20895	Ø 5, 6, 8, 10, 12 mm	25

SEKÁČE A VRTÁKY SDS+

SDS+
17x

- 2 x špičák
- 3 x sekáč
- 12 x vrták



Č.p.	špecifikácia	
20952		1

SADA VRTÁKOV DO MURIVA



Č.p.	špecifikácia	
20805	5 ks Ø 4 - 10 mm	10
20820	8 ks Ø 3 - 10 mm	10

SEKÁČE A VRTÁKY SDS+

SDS+
12x

- 1 x špičák 250 mm
- 1 x dutý 22 x 250 mm
- 1 x plochý 20 x 250 mm



Č.p.	špecifikácia	
20950	Ø 5 x 110 mm Ø 6 x 110 mm Ø 8 x 160 mm Ø 10 x 160 mm Ø 12 x 160 mm Ø 14 x 210 mm Ø 16 x 210 mm Ø 18 x 310 mm Ø 20 x 450 mm	6

SEKÁČE SADA

FESTA®

SDS+

4x



Č.p. špecifikácia

20954

1

SEKÁČ PLOCHÝ, ZAHNUTÝ 15°

FESTA®

SDS+

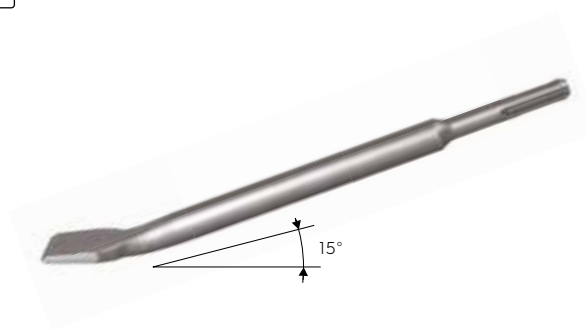

Č.p. špecifikácia

20936

40 x 250 mm

5

SEKÁČ

FESTA®

SDS
MAX

Č.p. špecifikácia

20940	25 x 280 mm
20941	40 x 280 mm
20942	75 x 280 mm
20943	25 x 400 mm
20944	40 x 400 mm
20945	25 x 600 mm
20946	50 x 600 mm

5

5

5

5

5

5

5

SEKÁČ

FESTA®

SDS+



Č.p. špecifikácia

20948	20 x 250 mm	25
20990	20 x 400 mm	25
20949	40 x 250 mm	25
20991	40 x 400 mm	25

25

25

25

25

SEKÁČ ŠPICATÝ

FESTA®

SDS
MAX

Č.p. špecifikácia

20937	Ø 18 x 280 mm	5
20938	Ø 18 x 400 mm	5
20939	Ø 18 x 600 mm	2

5

5

2

SEKÁČ ŠPICATÝ

FESTA®

SDS+



Č.p. špecifikácia

20947	250 mm	25
20992	400 mm	25

25

25

STOPKA UPÍNACIA PRE VYKRUŽOVACIE KORUNKY

FESTA®

SDS
MAX

Č.p. špecifikácia

24730 180 mm

1

DRÁŽKOVAC

FESTA®

SDS+



Č.p. špecifikácia

20956 22 x 250 mm

25

STOPKA UPÍNACIA PRE VYKRUŽOVACIE KORUNKY

FESTA®

SDS+



Č.p. špecifikácia

24731	300 mm	1
24732		1

1

1

ADAPTÉR SDS MAX NA SDS +

SDS
MAX

SDS+



Č.p. špecifikácia

20744

1

KORUNKA VYKRUŽOVACIA S SK PLÁTKAMI

SDS+

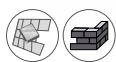

stopka upínacia pre vykrúžovacia korunky 24730, 24731 a 24732



Č.p.	špecifikácia	
24719	Ø 67 mm	1
24717	Ø 73 mm	1
24723	Ø 80 mm	1
24718	Ø 100 mm	1
24757	NEW Ø 115 mm	1
24758	NEW Ø 125 mm	1
24759	NEW Ø 150 mm	1

VYKRUŽOVÁK



Č.p.	špecifikácia	
24725	Ø 20-95mm	10

VYKRUŽOVÁK S KRYTOM



Č.p.	špecifikácia	
24726	Ø 20-95mm	1

VYKRUŽOVACIE KORUNKY - SADA

8x

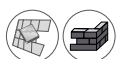

Č.p.	špecifikácia	
24747	Ø 33, 53, 67, 73, 83 mm unašeč, vrták, pilník	1

KORUNKY VYKRUŽOVACIE - SADA

6x



Č.p.	špecifikácia	
24745	Ø 33, 53, 67, 73 mm + unašeč, vrták	1

KORUNKA VYKRUŽOVACIA

FESTA

KORUNKA VYKRUŽOVACIA NA DLAŽBU - SADA

FESTA

3x



Č.p.	špecifikácia	
24735	Ø 33 mm	1
24736	Ø 43 mm	1
24737	Ø 53 mm	1
24738	Ø 67 mm	1
24739	Ø 73 mm	1
24740	Ø 83 mm	1
24741	Ø 103 mm	1



Č.p.	špecifikácia	
24746	Ø 103 mm + unašeč, vrták	1

UNÁŠAČ PRE VYKRUŽOVACIE KORUNKY

FESTA

VRTÁK PRE VYKRUŽOVACIE KORUNKY

FESTA



Č.p.	špecifikácia	
24748	Ø 33 - 83 mm	10
24743	Ø 33 - 103 mm	10

PILNÍK NA OBKLADY A DLAŽBU



Č.p.	špecifikácia	
22200	200 mm	20

KORUNKA VRTACIA DIAMANTOVÁ

FESTA

VODIČ NA VRTÁKY A VRTACIE KORUNKY

FESTA



Č.p.	špecifikácia	
24770	Ø 4 mm	1
24771	Ø 6 mm	1
24772	Ø 8 mm	1
24773	Ø 10 mm	1
24774	Ø 12 mm	1

- Pre vrtanie do skla a keramiky
- Nutné chladienie



Č.p.	špecifikácia	
24749		50

PILNÍK PLOCHÝ NA OBKLADY, DLAŽBU A MURIVO



- pre brúsenie tehál pred vloženíím stenové kotvy



Č.p.	špecifikácia	
22201	200 mm dvojí hrúbost	20



Č.p.	špecifikácia	
20379	Ø 4, 5, 6, 7, 8, 10, 12 mm	10

KORUNKA VYKRUŽOVACIA DIAMANTOVÁ

M14

Použitie bez chladenia vodou

 • keramické obklady
 • mramor
 • žula

• ukázkové video



Č.p.	špecifikácia		Č.p.	špecifikácia	
24760	Ø 6 mm M14	1	24767	Ø 45 mm M14	1
24761	Ø 8 mm M14	1	24791	Ø 50 mm M14	1
24762	Ø 10 mm M14	1	24768	Ø 53 mm M14	1
24763	Ø 12 mm M14	1	24792	Ø 60 mm M14	1
24764	Ø 14 mm M14	1	24793	Ø 65 mm M14	1
24790	Ø 20 mm M14	1	24769	Ø 68 mm M14	1
24765	Ø 28 mm M14	1	24794	Ø 75 mm M14	1
24766	Ø 35 mm M14	1	24796	Ø 83 mm NEW M14	1

KORUNKA VYKRUŽOVACIA DIAMANTOVÁ

NEW

 • keramické obklady
 • mramor
 • žula

Č.p.	špecifikácia	
24700	Ø 6 mm	1
24701	Ø 8 mm	1
24702	Ø 10 mm	1
24703	Ø 12 mm	1
24704	Ø 14 mm	1
24705	Ø 20 mm	1

KORUNKA VYKRUŽOVACIA DIAMANTOVÁ

NEW
6x

 • keramické obklady
 • mramor
 • žula

Č.p.	špecifikácia	
24798	Ø 6, 8, 10, 12, 14, 20 mm	1

KORUNKA BRÚSNA DIAMANTOVÁ

M14

Použitie bez chladenia vodou

 • keramické obklady
 • mramor
 • žula

Č.p.	špecifikácia	
24795	Ø 20 x 50 mm	1

VRTÁK NA SKLO A KERAMIKU

TiN
1/4"

Č.p.	špecifikácia	
24780	Ø 4 mm	10
24781	Ø 5 mm	40
24782	Ø 6 mm	40
24783	Ø 8 mm	40
24784	Ø 10 mm	40
24785	Ø 12 mm	40
24786	NEW Ø 14 mm	1
24787	NEW Ø 16 mm	1
24788	NEW Ø 18 mm	1
24789	NEW Ø 20 mm	1

SEKÁČE, JAMKÁRE, PRIEBOJNÍKY - SADA

FESTA



SEKÁČE, JAMKÁRE, PRIEBOJNÍKY - SADA

FESTA

CrV

12x





 2, 6, 8 mm
 10, 12, 16 mm
 Ø 1,5-3-4-5-6-8 mm

Č.p. špecifikácia

19487



4

 2 x 140, 8 x 115 mm
 12 x 152, 10 x 142 mm
 Ø 3 x 152, 6 x 152 mm

Č.p. špecifikácia

19486



10

SEKÁČE - SADA

FESTA

SEKÁČ ZÁMOČNÍCKY KRÍŽOVÝ

FESTA

CrV

3x



 10, 12, 16 mm

Č.p. špecifikácia

19485



10

Č.p. špecifikácia

19429



200 mm



1

SEKÁČ PLOCHÝ

FESTA

SEKÁČ ZÁMOČNÍCKY PLOCHÝ

CrV



Č.p. špecifikácia

Č.p.	špecifikácia		
19410	200 mm	20 mm	10
19411	250 mm	25 mm	10
19412	300 mm	25 mm	10
19418	400 mm	25 mm	5
19419	500 mm	25 mm	5



10

Č.p. špecifikácia

19436

200 mm 20 mm



15

PRIEBOJNÍKY - SADA

FESTA

CrV

6x



Č.p.	špecifikácia	
19483	Ø 3, 4, 5, 6, 7, 8 mm	5

PRIEBOJNÍKY - SADA

FESTA

CrV

6x



Č.p.	špecifikácia	
19482	Ø 3, 4, 5, 6, 8 mm	5

PRIEBOJNÍK

FESTA

CrV



Č.p.	špecifikácia	
19472	Ø 4 mm 150 mm	1
19473	Ø 5 mm 150 mm	1
19474	Ø 6 mm 150 mm	1

PRIEBOJNÍKY - SADA

FESTA

CrV

3x



Č.p.	špecifikácia	
19480	Ø 0.8, 1.5, 2.5 mm	10

JAMKÁR

FESTA

CrV



Č.p.	špecifikácia	
19477	Ø 2,5 mm	20

JAMKÁRE - SADA

FESTA

CrV

3x



Č.p.	špecifikácia	
19481	Ø 0.8, 1.5, 2.5 mm	10

JAMKÁR AUTOMATICKÝ

FESTA

CrV



Č.p.	špecifikácia	
19478	Ø 2,5 mm	20

REZAČ SKLA



Č.p.	špecifikácia	
20350	130 mm	12

VRTÁK HADOVITÝ DO DREVA

FESTA®



Č.p.	špecifikácia		Č.p.	špecifikácia	
20980	Ø 6 x 230 mm	1	20984	Ø 16 x 230 mm	1
20957	Ø 6 x 300 mm	1	20899	Ø 16 x 300 mm	1
20981	Ø 8 x 230 mm	1	20917	Ø 16 x 450 mm	1
20958	Ø 8 x 300 mm	1	20922	Ø 16 x 600 mm	1
20982	Ø 10 x 230 mm	1	20918	Ø 18 x 450 mm	1
20896	Ø 10 x 300 mm	1	20923	Ø 18 x 600 mm	1
20913	Ø 10 x 450 mm	1	20919	Ø 20 x 450 mm	1
20983	Ø 12 x 230 mm	1	20924	Ø 20 x 600 mm	1
20897	Ø 12 x 300 mm	1	20724	Ø 22 x 450 mm	1
20915	Ø 12 x 450 mm	1	20725	Ø 24 x 450 mm	1
20920	Ø 12 x 600 mm	1	20726	Ø 26 x 450 mm	1
20898	Ø 14 x 300 mm	1	20727	Ø 28 x 450 mm	1
20916	Ø 14 x 450 mm	1	20728	Ø 30 x 450 mm	1
20921	Ø 14 x 600 mm	1			



VRTÁKY HADOVITÉ DO DREVA - SÚPRAVA

FESTA®

5x



Č.p.	špecifikácia
20911	Ø 8, 10, 12, 14, 16 x 460 mm



10

VRTÁKY HADOVITÉ DO DREVA - SÚPRAVA

FESTA®

6x



Č.p.	špecifikácia
20912	Ø 6, 8, 10, 12, 16, 20 x 230 mm



10

VRTÁK DO DREVA



Č.p.	špecifikácia		Č.p.	špecifikácia		Č.p.	špecifikácia	
20729	Ø 6 x 400 mm	1	20732	Ø 12 x 400 mm	1	20734	Ø 16 x 400 mm	1
20731	Ø 8 x 400 mm	1	20738	Ø 12 x 600 mm	1	20740	Ø 16 x 600 mm	1
20736	Ø 8 x 600 mm	1	20733	Ø 14 x 400 mm	1	20735	Ø 18 x 400 mm	1
20730	Ø 10 x 400 mm	1	20739	Ø 14 x 600 mm	1	20741	Ø 18 x 600 mm	1
20737	Ø 10 x 600 mm	1						

VRTÁK DO DREVA



Č.p.	špecifikácia	
21440	Ø 4 x 75 mm	1
21441	Ø 5 x 85 mm	1
21442	Ø 6 x 90 mm	1
21443	Ø 7 x 105 mm	1
21444	Ø 8 x 115 mm	1
21445	Ø 9 x 120 mm	1
21446	Ø 10 x 120 mm	1

VRTÁKY DO DREVA - SÚPRAVA



Č.p.	špecifikácia	
20910	8 ks Ø 3, 4, 5, 6, 7, 8, 9, 10 mm	10
20905	5 ks Ø 4, 5, 6, 8, 10 mm	10



VRTÁK FRÉZOVACÍ

HSS

TiN



Č.p. 20460
špecifikácia Ø 6 mm

50

VRTÁKY FRÉZOVACIE - SADA

HSS

TiN

6x

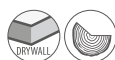

Č.p. 20450
špecifikácia Ø 3, 4, 5, 6, 6.5, 8 mm

1

VRTÁK NA KONFIRMÁTY - VYBRÚSENÝ

FESTA

HSS



1

Č.p. 20210
špecifikácia Ø 7.5, 5 mm

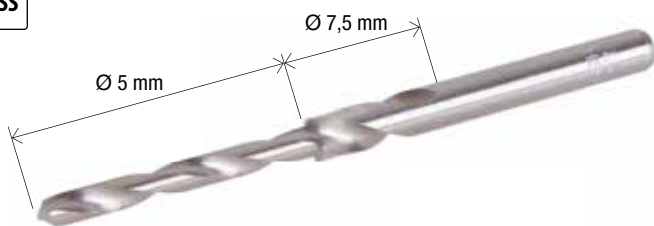

SUKOVNÍKY - SADA

5x



Č.p. 21530
špecifikácia Ø 15, 20, 25, 35 mm Ø 8 mm

1

VRTÁKY DO DREVA - SÚPRAVA

6x



Č.p. 20901
špecifikácia Ø 10, 12, 16, 18, 20, 25 mm

20

TVAROVÉ FRÉZY DO DREVA

5x



Č.p. 21450
špecifikácia Ø 8 mm

1

TVAROVÉ FRÉZY DO DREVA

12x



Č.p. 21451
špecifikácia Ø 8 mm

1

TVAROVÉ FRÉZY DO DREVA

24x



Č.p. 21452
špecifikácia Ø 8 mm

1

TVAROVÉ FRÉZY DO DREVA

35x



Č.p. 21453
špecifikácia Ø 8 mm



1

TVAROVÉ FRÉZY DO DREVA

59x



Č.p. 21454
špecifikácia Ø 8 mm



1

ROTAČNÉ RAŠPLE

5x



6 mm  12 mm

Č.p. 21541
špecifikácia



25

ROTAČNÉ BRÚSKY

5x



Č.p. 21540
špecifikácia Ø 3 mm, 6 mm



25

NADSTAVCE NA PRIAMU BRÚSKU

100x



Č.p. 24755
špecifikácia



5

NADSTAVCE NA PRIAMU BRÚSKU

150x



Č.p. 24756
špecifikácia



1

PÍLY VYKRUŽOVACIE



VYKRUŽOVACIA PÍLA NA DREVO A SADROKARTÓN



12x

Ø 19 mm
 Ø 22 mm
 Ø 25,5 mm
 Ø 36 mm
 Ø 44 mm
 Ø 51 mm
 Ø 60 mm
 Ø 67 mm
 Ø 76 mm
 Ø 82 mm
 inbus
 2x hlavička



Č.p. špecifikácia
24712 6 tpi



20



Č.p.	špecifikácia	
24715	1' Ø 67 mm 6 tpi	5
24713	1' Ø 73 mm 6 tpi	5
24714	1' Ø 102 mm 6 tpi	5
24720	1' Ø 152 mm 6 tpi	5

PÍLY VYKRUŽOVACIE



PÍLY VYKRUŽOVACIE

8x

Ø 64 mm
 Ø 73 mm
 Ø 89 mm
 Ø 102 mm
 Ø 127 mm
 inbus
 hlavička

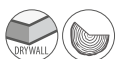

Č.p. špecifikácia
24706 6 tpi

20

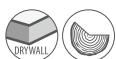

Č.p.	špecifikácia	
24721	1' Ø 26, 32, 38, 45, 50, 56, 63 mm	10
24722	2' Ø 26, 32, 38, 45, 50, 56, 63 mm	10

VYKRUŽOVÁK NASTAVITEĽNÝ

NEBOŽIECE - SADA

4x

HOBBY

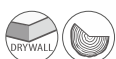

Č.p. špecifikácia
24716 Ø 30 - 120 mm



5

Č.p. špecifikácia
20381 Ø 2, 3, 4, 5 mm

20

ADAPTÉR SDS MAX NA SDS +

SDS MAX → SDS+



Č.p. špecifikácia

20744



1

ADAPTÉR SDS +

SDS+



Č.p. špecifikácia

20745



1

SKĽUČOVADLO

FESTA

1/2"



Č.p. špecifikácia

20960 1-13 mm + 2 klíče, 1/2 - 20 UNF



1

20966 náhradný klúčik



30

SKĽUČOVADLO RÝCHLOUPÍNACIE

FESTA

1/2"



Č.p. špecifikácia

20965 1,5 - 13 mm 1/2' - 20 UNF



1

SKĽUČOVADLO RÝCHLOUPÍNACIE

1/2"



Č.p. špecifikácia

20961 1,5 - 13 mm 1/2' - 20 UNF



1

NADSTAVEC NA VRTANIE 90°



Č.p. špecifikácia

20365 Ø 1,5 - 10 mm



10

SKĽUČOVADLO RÝCHLOUPÍNACIE DO AKU

1/4"



Č.p. špecifikácia

20963 Ø 1 - 6 mm



10

RAZNICA ČÍSLA



Č.p. špecifikácia

20972 6 mm



5

20973 8 mm

5

VÝSEČNÍKY

13x



Č.p. špecifikácia

24695 Ø 5, 6, 8, 10, 11, 13, 16, 19, 22, 25, 28, 32, 35 mm



5

DIEROVAČE

24690 - Ø 2,5 mm
 Ø 3 mm
 Ø 4 mm
 Ø 5 mm
 Ø 6 mm
 Ø 7 mm
 Ø 8 mm
 Ø 9 mm
 Ø 10 mm

24691 - Ø 2 mm
 Ø 2,5 mm
 Ø 3,2 mm
 Ø 4 mm
 Ø 4,8 mm
 Ø 5 mm
 Ø 6,4 mm
 Ø 8 mm
 Ø 9,5 mm
 Ø 11,1 mm
 Ø 12,7 mm
 Ø 14 mm
 Ø 15,8 mm
 Ø 19 mm
 Ø 22 mm



Č.p. špecifikácia

24690 9 ks Ø 2,5 - 10 mm



10

24691 15 ks Ø 2 - 22 mm



5

RAZNICA ABECEDY



Č.p. špecifikácia

20970 6 mm



5

20971 8 mm

5

FESTA®



KEFA MISKOVÁ, VLNITÁ, POMOSADZENÁ

M14

FESTA

KEFA MISKOVÁ, VLNITÁ, POMOSADZENÁ

M14

FESTA

KEFA MISKOVÁ, VLNITÁ, MOSADZNÁ

M14

FESTA



20mm



· pomosadzený

Č.p.	špecifikácia	úchyt	drôt	
21900	Ø 100 mm	M14	s 0,3	60
21902	Ø 125 mm	M14	s 0,3	42



10mm



· pomosadzený

Č.p.	špecifikácia	úchyt	drôt	
22001	Ø 100 mm	M14	s 0,3	60
21901	Ø 125 mm	M14	s 0,3	42



· mosadzný

Č.p.	špecifikácia	úchyt	drôt	
21920	Ø 100 mm	M14	s 0,3	60

KEFA HRNČEKOVÁ, VLNITÁ, POMOSADZENÁ

M14

FESTA

KEFA HRNČEKOVÁ, VLNITÁ, MOSADZNÁ

M14

FESTA

KEFA OKRUŽNÁ, VLNITÁ, POMOSADZENÁ

M14

FESTA

· redukčné krúžky



· pomosadzený

Č.p.	špecifikácia	úchyt	drôt	
21903	Ø 65 mm	M14	s 0,3	60
22002	Ø 75 mm	M14	s 0,3	80
21904	Ø 85 mm	M14	s 0,3	60
22003	Ø 100 mm	M14	s 0,3	36
21905	Ø 125 mm	M14	s 0,3	24
21906	Ø 150 mm	M14	s 0,3	12



· mosadzný

Č.p.	špecifikácia	úchyt	drôt	
21925	Ø 75 mm	M14	0,3 mm	80
21926	Ø 100 mm	M14	0,3 mm	36



· pomosadzený

Č.p.	špecifikácia	úchyt	drôt	
22007	Ø 100 mm	Ø 20 mm	s 0,3	60
22008	Ø 125 mm	Ø 20 mm	s 0,3	42
22009	Ø 150 mm	Ø 32,2 mm	s 0,3	32
22010	Ø 175 mm	Ø 32,2 mm	s 0,3	20
22011	Ø 200 mm	Ø 32,2 mm	s 0,3	20

KEFA HRNČEKOVÁ, COPY

M14

FESTA



· patentované



Č.p.	špecifikácia	úchyt	drôt	
22004	Ø 65 mm	M14	s 0,3	60
22005	Ø 75 mm	M14	s 0,3	24
22006	Ø 100 mm	M14	s 0,3	24
21907	Ø 125 mm	M14	s 0,3	24
21908	Ø 150 mm	M14	s 0,3	12

KEFA HRNČEKOVÁ, COPY - NEREZ

INOX

FESTA

M14



· patentované



Č.p.	špecifikácia	úchyt	drôt	
22037	Ø 65 mm	M14	s 0,5	60
22038	Ø 80 mm	M14	s 0,5	24

KEFA RADIÁLNA, COPY

M14

FESTA



· patentované



Č.p.	špecifikácia	úchyt	drôt	počet copů/	
21911	Ø 100 mm	M14	s 0,5	30	60
21912	Ø 115 mm	M14	s 0,5	32	42
21913	Ø 125 mm	M14	s 0,5	36	42
21914	Ø 150 mm	M14	s 0,5	40	32

KEFA RADIÁLNA, COPY

M14

FESTA



· patentované



Č.p.	špecifikácia	úchyt	drôt	
22012	Ø 100 mm	M14	s 0,5	60
22013	Ø 115 mm	M14	s 0,5	42
22014	Ø 125 mm	M14	s 0,5	42
22015	Ø 150 mm	M14	s 0,5	32
22016	Ø 178 mm	M14	s 0,5	20

KEFA RADIÁLNA, COPY

INOX

FESTA

M14



· patentované



Č.p.	špecifikácia	úchyt	drôt	
22039	Ø 100 mm	M14	s 0,5	60
22040	Ø 125 mm	M14	s 0,5	42

KEFA MISKOVÁ, COPY

M14

FESTA



· patentované



Č.p.	špecifikácia	úchyt	drôt	
22017	Ø 100 mm	M14	s 0,5	60
21909	Ø 115 mm	M14	s 0,5	42
21910	Ø 125 mm	M14	s 0,5	42

KEFA OKRUŽNÁ, COPY, STOPKA

FESTA



· patentované



Č.p.	špecifikácia	drôt	
22023	Ø 75 mm	s 0,5	10

KEFA HRNČEKOVÁ, COPY, STOPKA

FESTA



· patentované



Č.p.	špecifikácia	drôt	
22024	Ø 75 mm	s 0,5	12

KEFA MISKOVÁ, COPY, STOPKA

FESTA



· patentované



Č.p.	špecifikácia	drôt	
22025	Ø 75 mm	s 0,5	12

KEFA OKRUŽNÁ, VLNITÁ, POMOSADZENÁ

FESTA



pomosadený



Č.p.	špecifikácia	drôt	
22026	Ø 50 mm	s 0,3	15
22027	Ø 63 mm	s 0,3	15
22028	Ø 75 mm	s 0,3	10
22029	Ø 100 mm	s 0,3	15

KEFA HRNČEKOVÁ, VLNITÁ, POMOSADZENÁ

FESTA



pomosadený



Č.p.	špecifikácia	drôt	
22030	Ø 65 mm	s 0,3	12
22031	Ø 75 mm	s 0,3	12

KEFA KONCOVÁ, COPY, STOPKA

FESTA



patentované



Č.p.	špecifikácia	drôt	
22021	Ø 19 mm	s 0,5	30
22022	Ø 22 mm	s 0,5	25

KEFA KONCOVÁ, VLNITÁ, STOPKA

FESTA



Č.p.	špecifikácia	drôt	
22058	Ø 12 mm	s 0,3	25
22059	Ø 25 mm	s 0,3	25

KEFA KONCOVÁ, VLNITÁ, POMOSADZENÁ

FESTA



pomosadený



Č.p.	špecifikácia	drôt	
22018	Ø 12 mm	s 0,3	15
22019	Ø 17 mm	s 0,3	15
22020	Ø 25 mm	s 0,3	25

KEFA OKRUŽNÁ, NYLONOVÁ

FESTA

M14



Č.p.	špecifikácia	úchyt	drôt	
21930	Ø 125 mm	M14	1,2 mm	10
21931	Ø 150 mm	M14	1,2 mm	15

KEFA HRNČEKOVÁ, VLNITÁ, NYLONOVÁ

FESTA

M14



Č.p.	špecifikácia	úchyt	drôt	
21940	Ø 75 mm	M14	1,2 mm	1
21941	Ø 100 mm	M14	1,2 mm	1

KEFA OKRUŽNÁ, NYLONOVÁ, STOPKA

FESTA



Č.p.	špecifikácia	drôt	
21935	Ø 50 mm	1,2 mm	1
21936	Ø 75 mm	1,2 mm	1
21937	Ø 100 mm	1,2 mm	1

KEFA OKRUŽNÁ, NYLONOVÁ, STOPKA

FESTA

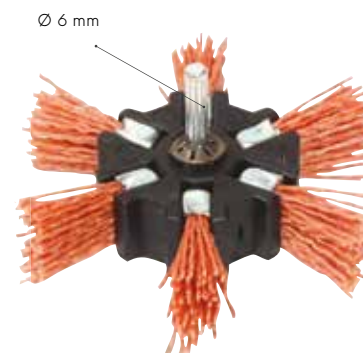

Č.p.	špecifikácia	drôt	
22032	Ø 100 mm	1,2 mm	12

ŠTETEC DRÔTENÝ



Č.p.	špecifikácia	drôt	
22158	200 mm	ocel'	1
22159	200 mm	mosaz	1

KEFA VLNITÁ



Č.p.	špecifikácia	drôt	
22035	270 mm	ocel'	24
22036	270 mm	nerez	24

KEFA OCEĽOVÁ



Č.p.	špecifikácia	rady	
22033	300 mm	4 rady	12
22034	300 mm	5 rád	12

KEFA POMOSADZENÁ



Č.p.	rady	
22078	3 rady	20

KEFA POMOSADZENÁ



Č.p.	špecifikácia	rady	
22079	300 mm	4 rady	10

KEFA OCEĽOVÁ



Č.p.	špecifikácia	rady	
22080	270 mm	5 rád	12

KEFA MOSADZNÁ



Č.p.	špecifikácia	rady	
22082	300 mm	5 rád	12

KEFY OCEĽOVÉ, POMOSADZENÉ - SADA

3x



Č.p.	rady	
22081	3 rady	10

KEFY - SADA

3x



Č.p.	špecifikácia	drôt	
22086	180 mm		12

nylon, nerez, mosadz

KOTUČ DIAMANTOVÝ LEŠTIACI Ø 100 mm, SO SUCHÝM ZIPSOM

FESTA

UNÁŠAČ BRÚSNEHO PAPIERA SO SUCHÝM ZIPSOM

FESTA



M14



- M14 | Ø 8 mm
- EVA 10 mm



Č.p.	špecifikácia	
22062	Ø 115 mm	25
22063	Ø 125 mm	25
22064	Ø 150 mm	10



- keramické obklady
- sklo
- mramor
- žula



Č.p.	hrúbosť	
22701	50	1
22702	100	1
22703	200	1
22704	400	1
22705	800	1
22706	1500	1
22707	3000	1

UNÁŠAČ PRE FÍBROVÉ KOTUČE

M14

FESTA

NORTON
MADE IN EU



Č.p.	špecifikácia	
22073	Ø 125 mm, M14	1
22074	Ø 150 mm, M14	1

UNÁŠAČ DIAMANTOVÝCH LEŠTIACICH KOTUČOV

M14



- pre uhlovú brúsku



Č.p.	špecifikácia	
22043	Ø 100 mm so suchým zipsom	1

UNÁŠAČ BRÚSNEHO PAPIERA

M14



- pre uhlovú brúsku



Č.p.	špecifikácia	
22044	Ø 125 mm M14 so suchým zipsom	15
22060	Ø 150 mm M14 so suchým zipsom	6

ADAPTÉR

NEW

M14

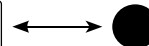

Č.p.	špecifikácia	
22087		1

UNÁŠAČ BRÚSNEHO PAPIERA KÍBVOVÝ



Č.p.	špecifikácia	
22061	Ø 125 mm so suchým zipsom Ø 8 mm	5

UNÁŠAČ BRÚSNEHO PAPIERA



Č.p.	špecifikácia	
22041	Ø 125 mm upínanie skrutkou	11
22042	Ø 125 mm so suchým zipsom	11

KOTÚČ LEŠTIACI, BARÁNOK



Č.p.	špecifikácia	
22065	Ø 125 mm so suchým zipsom	20
22066	Ø 150 mm so suchým zipsom	20

KOTÚČ LEŠTIACI, BARÁNOK S GOLIEROM



Č.p.	špecifikácia	
22068	Ø 125 mm	20
22069	Ø 150 mm	20

FILC LEŠTIACI SO SUCHÝM ZIPSOM

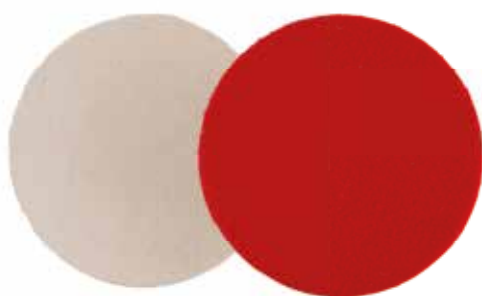

Č.p.	špecifikácia	
22070	Ø 115 mm	20
22071	Ø 125 mm so suchým zipsom	20
22072	Ø 150 mm	20

KOTÚČ NYLONOVÝ, BRÚSNY



Ø 6 mm

Č.p.	špecifikácia	
22091	Ø 50 mm P240	1
22092	Ø 75 mm P240	1
22093	Ø 100 mm P240	1

KOTÚČ NYLON S PODLOŽKOU

NEW



Č.p.	špecifikácia	
21798	Ø 125 mm Ø 22,2 mm	1

KOTÚČ NYLONOVÝ, STOPKA



Ø 6 mm



Č.p.	špecifikácia	
22088	Ø 65 mm	9
22090	Ø 100 mm	5

KOTÚČ NYLON S PODLOŽKOU



Č.p.	špecifikácia	
22083	Ø 115 mm Ø 22,2 mm	10
22084	Ø 125 mm Ø 22,2 mm	10
22085	Ø 150 mm Ø 22,2 mm	10

KOTÚČ NYLONOVÝ



Č.p.	špecifikácia	
22095	Ø 178 mm	1

KOTÚČE FIBROVÉ - Ø 125 MM

3x



Č.p.	hrubosť	
22160	P40	1
22161	P60	1
22162	P80	1
22163	P100	1
22164	P120	1

KOTÚČE FIBROVÉ - Ø 150 MM

3x



Č.p.	hrubosť	
22165	P40	1
22166	P60	1
22167	P80	1
22168	P100	1
22169	P120	1

PAPIER BRÚSNY Ø 125 MM, SO SUCHÝM ZIPSOM

3x



Č.p.	hrubosť	
22045	P40	1
22046	P60	1
22047	P80	1
22048	P100	1
22049	P120	1
22050	P150	1
22051	P180	1
22052	P220	1

PAPIER BRÚSNY Ø 150 MM, SO SUCHÝM ZIPSOM

3x



Č.p.	hrubosť	
22053	P40	1
22054	P60	1
22055	P80	1
22056	P100	1
22057	P120	1

VIBRAČNÝ VÝSEK - 94 X 94 X 94 MM

5x



Č.p.	hrubosť	
21831	P60	1
21832	P80	1
21834	P120	1

PAPIER BRÚSNY SO SUCHÝM ZIPSOM - 125 MM

3x



Č.p.	hrubosť	
22096	P40	20
22097	P60	20
22098	P80	20
22099	P120	20

NEKONEČNÝ BRÚSNÝ PÁS - 75 X 533 MM

3x



Č.p.	hrubosť	
21810	P40	20
21811	P60	20
21812	P80	20
21813	P100	20
21814	P120	20

PAPIER BRÚSNY 93 X 230 MM

5x



PAPIER BRÚSNY 115 X 280 MM

5x



Č.p.	hrubosť	počet otvorov	
21740	P40	8	20
21741	P60	8	20
21742	P80	8	20
21743	P100	8	20
21744	P120	8	20

Č.p.	hrubosť	počet otvorov	
21750	P40	10	20
21751	P60	10	20
21752	P80	10	20
21753	P100	10	20
21754	P120	10	20

PLÁTNO BRÚSNE 230 X 280 MM

10x



Č.p.	hrubosť	
21732	P40	1
21734	P60	1
21735	P80	1
21736	P100	1
21737	P120	1

PAPIER BRÚSNY VODEODOLNÝ 230 X 280 MM

10x



Č.p.	hrubosť	
21701	P60	1
21702	P80	1
21703	P100	1
21704	P120	1
21705	P150	1
21706	P180	1
21709	P240	1

PAPIER BRÚSNY 230 X 280 MM

10x



Č.p.	hrubosť	
21715	P40	1
21716	P60	1
21717	P80	1
21718	P100	1
21719	P120	1
21720	P150	1
21721	P180	1
21724	P240	1

DRŽIAK BRÚSNEHO PAPIERA 170 X 70 MM

FESTA



DRŽIAK BRÚSNEHO PAPIERA



DRŽIAK BRÚSNEHO PAPIERA 125 X 68 MM



· rýchlopínaci

Č.p.	špecifikácia	materiál	
22067	170 x 70 mm	buková rukoväť	10

Č.p.	špecifikácia		
22075	210 x 105 mm	plastový	60
22076	160 x 85 mm	plastový	60

Č.p.	špecifikácia	materiál	
22077	125 x 68 mm	guma	60

HUBA DIAMANTOVÁ BRÚSNA

FESTA

90 x 55 x 25 mm



- keramické obklady
- sklo
- mramor
- žula

Č.p.	hrubosť	
22115	P60	1
22116	P120	1
22117	P200	1

BRÚSNY LAMELOVÝ KOTUČ NA STOPKE



Č.p.	hrubosť	špecifikácia	
21850	P40		1
21851	P60		1
21852	P80	20 x 20, Ø 6 mm	1
21853	P100		1
21854	P120		1
21855	P40		1
21856	P60		1
21857	P80	30x30, Ø 6mm	1
21858	P100		1
21859	P120		1
21860	P40		1
21861	P60		1
21862	P80	60x30, Ø 6mm	1
21863	P100		1
21864	P120		1

HUBA BRÚSNA 100 X 70 X 28 MM - SKOSENÁ

FESTA

NEW



Č.p.	hrubosť	
22106	P 60	10
22107	P 80	10
22108	P 100	10
22109	P 120	10

HUBA BRÚSNA 100 X 70 X 25 MM

FESTA



Č.p.	hrubosť	
22100	P60	20
22101	P80	20
22102	P100	20
22103	P120	20
22104	P180	20
22105	P220	20

HUBA BRÚSNA 120 X 95 X 10 MM

FESTA

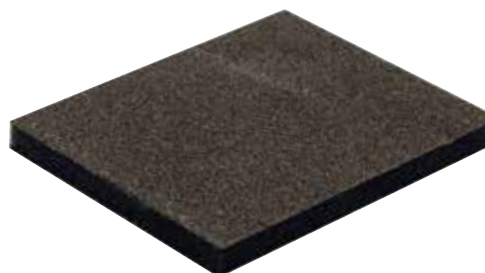

Č.p.	hrubosť	
22110	P80	20
22111	P120	20
22112	P180	20
22113	P220	20

NÁRADIE NA SADROKARTÓN



RAŠPĽA NA SADROKARTÓN



Č.p.	špecifikácia	
22120	250 x 40 mm	10

RAŠPĽA NA SADROKARTÓN



Č.p.	špecifikácia	
22121	250 x 40 mm	10
22122	140 x 40 mm	6

RAŠPĽA NA SADROKARTÓN



Č.p.	špecifikácia	
22126	155 x 40 mm	1

RAŠPĽA NA SADROKARTÓN



Č.p.	špecifikácia	
22125	Ø 250 x 40 mm	6

RAŠPĽA NA SADROKARTÓN



Č.p.	špecifikácia	
22124	Ø 250 x 16 mm	10

RAŠPĽA NA SADROKARTÓN



Č.p.	špecifikácia	
22123	60 x 40 mm	6

PÍLKA NA SADROKARTÓN

FESTA®



Č.p.	špecifikácia	
24159	150 mm	12

HOBLÍK NA SADROKARTÓN

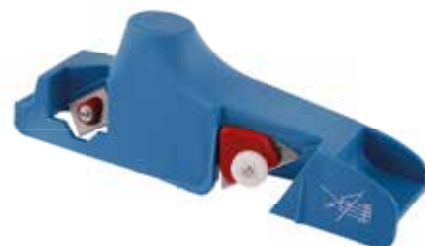

Č.p.	špecifikácia	
34315		10
34316	náhradný brit	1

PÍLKA VRTACIA NA SADROKARTÓN



Č.p.	špecifikácia	
24190	270 mm	10

RAŠPĽA NÁHRADNÁ



Č.p.	špecifikácia	
22130	250 x 40 mm	20
22129	155 x 40 mm	20
22132	140 x 40 mm	20
22133	60 x 40 mm	20
22134	Ø 16 x 250 mm	20



RAŠPLE A PILNÍKY

PILNÍK ŠTVORHRANNÝ

FESTA



Č.p.	špecifikácia	hrúbosť	
22184	250 mm	2	10

PILNÍK TROJHRANNÝ

FESTA



Č.p.	špecifikácia	hrúbosť	
22183	250 mm	2	10

PILNÍK TROJHRANNÝ NA PÍLOVÉ ZUBY

FESTA



Č.p.	špecifikácia	hrúbosť	
22178	150 mm	1	10

PILNÍKY - SADA

FESTA



5x



Č.p.	špecifikácia	hrúbosť	
22209	150 mm	2	10
22186	250 mm	2	5

PILNÍK PLOCHÝ

FESTA



Č.p.	špecifikácia	hrúbosť	
22206	150 mm	2	10
22180	250 mm	2	10

PILNÍK POLOGUĽATÝ

FESTA



Č.p.	špecifikácia	hrúbosť	
22207	150 mm	2	10
22182	250 mm	2	10

PILNÍK GUĽATÝ

FESTA



Č.p.	špecifikácia	hrúbosť	
22181	250 mm	2	10

PILNÍKY - SADA

FESTA



3x



Č.p.	špecifikácia	hrúbosť	
22208	150 mm	2	10
22185	250 mm	2	5

RAŠPĽA PLOCHÁ

FESTA



Č.p.	špecifikácia	
22202	150 mm	10
22197	300 mm	10

RAŠPĽA GULATÁ

FESTA



Č.p.	špecifikácia	
22204	150 mm	10
22205	250 mm	10
22198	300 mm	10

RAŠPĽA POLOGULATÁ

FESTA



Č.p.	špecifikácia	
22203	150 mm	6
22199	300 mm	6

RAŠPĽA - SADA

FESTA



3x



Č.p.	špecifikácia	
22195	300 mm	5

PILNÍK NA REŤAZOVÚ PÍLU

FESTA



Č.p.	špecifikácia	
22170	200 mm 3,5 mm	20
22171	200 mm 4 mm	10
22172	200 mm 4,5 mm	10

Č.p.	špecifikácia	
22173	200 mm 5 mm	10
22174	200 mm 5,5 mm	10

PILNÍKY IHLOVÉ - SADA

FESTA

10x



Č.p.	špecifikácia	
22188		20

SADA NA BRÚSENIE REŤAZÍ

FESTA



Ø 4 mm



Č.p.	špecifikácia	
22190	300 mm	5

PILNÍKY DIAMANTOVÉ - SADA

FESTA

10x



Č.p.	špecifikácia	
22189		25

FESTA®



KOTÚČ PÍLOVÝ DO DREVA S SK PLÁTKAMI

FESTA

Č.p.	špecifikácia	počet zubov	
	Ø 115 mm		
22300	Ø 115 x 22 mm	40	1
	Ø 125 mm		
22301	Ø 125 x 22 mm	40	1
	Ø 140 mm		
22302	Ø 140 x 20 mm	24	1
22303	Ø 140 x 20 mm	30	1
	Ø 150 mm		
22305	Ø 150 x 20 mm	24	1
	Ø 160 mm		
22307	Ø 160 x 20 mm	18	1
22309	Ø 160 x 20 mm	24	1
22310	Ø 160 x 20 mm	30	1
22311	Ø 160 x 20 mm	36	1
22312	Ø 160 x 20 mm	48	1
22313	Ø 160 x 20 mm	60	1
	Ø 165 mm		
22314	Ø 165 x 20 mm	24	NEW 1
	Ø 180 mm		
22315	Ø 180 x 30 mm	24	1
22317	Ø 180 x 30 mm	50	1
22318	Ø 180 x 20 mm	50	1
	Ø 190 mm		
22319	Ø 190 x 20 mm	40	1
22320	Ø 190 x 30 mm	40	1
	Ø 200 mm		
22322	Ø 200 x 30 mm	24	1
22324	Ø 200 x 30 mm	40	1
22326	Ø 200 x 30 mm	60	1
	Ø 205 mm		
22328	Ø 205 x 30 mm	40	1
22329	Ø 205 x 30 mm	60	1
	Ø 210 mm		
22332	Ø 210 x 30 mm	40	1
22333	Ø 210 x 30 mm	60	1
	Ø 250 mm		
22335	Ø 250 x 30 mm	40	1
22337	Ø 250 x 30 mm	60	1
	Ø 300 mm		
22340	Ø 300 x 30 mm	40	1
22343	Ø 300 x 30 mm	60	1
22345	Ø 300 x 30 mm	96	1
	Ø 350 mm		
22350	Ø 350 x 30 mm	40	1
22351	Ø 350 x 30 mm	54	1
	Ø 400 mm		
22355	Ø 400 x 30 mm	40	1
22357	Ø 400 x 30 mm	60	1
	Ø 500 mm		
22365	Ø 500 x 30 mm	60	1
	Ø 600 mm		
22370	Ø 600 x 30 mm	60	1

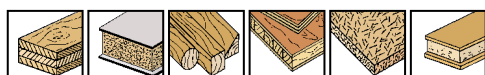

REDUKČNÝ KRÚŽOK



Č.p.	špecifikácia	
22399	Ø 20 16 mm	1
22398	Ø 30 25 mm	1

PROFESIONÁLNE PRIAMOČIARE PÍLKY

VYROBENÉ V NEMECKU TECHNOLOGIOU VYPALOVANÍM LASEROM

PÍLKA PRIAMOČIARA HSS - UCHYTENIE AEG, BOSCH, FESTO, MAKITA, METABO

	24060	50mm/1mm	0,7 mm/ 36TPI	31007	5 ks	10
	24061	50mm/1mm	1,2 mm/ 21TPI	31012	5 ks	10
	24062	50mm/1mm	2,0 mm/ 13TPI	31020	5 ks	10
	24063	75mm/1mm	3,0 mm/ 8TPI	31030	5 ks	10
	24064	100mm/1mm	1,2 mm/ 21TPI	31112	5 ks	10
	24065	100mm/1,3mm	2,0 mm/ 13TPI	31112	5 ks	10
	24066	75mm/1,45mm	2,0 mm/ 13TPI	31220	5 ks	10
	24067	120mm/1,3mm	1,8 - 2,4 mm/ 10 - 14 TPI	31220	5 ks	10
	24068	75mm/1,45mm	2,5 mm/ 10 TPI	32225	5 ks	10
	24069	75mm/1,45mm	4 mm/ 6 TPI	32240	5 ks	10
	24070	75mm/1,3mm	4 mm/ 6 TPI	32340	5 ks	10
	24071	75mm/1,3mm	4 mm/ 6 TPI	32440	5 ks	10
	24072	75mm/1,45mm	2,5 mm/ 10 TPI	32625	5 ks	10
	24073	85mm/1,45mm	3 mm/ 8 TPI	32730	5 ks	10
	24074	85mm/1,45mm	4 mm/ 6 TPI	32730	5 ks	10
	24075	75mm/1,45mm	2,5 1,2 mm/10 21 TPI	32825	5 ks	10
	24076	75mm/1,7mm	4 mm 6 TPI	32940	5 ks	10
	24077	120mm/1,3mm	4 mm 6 TPI	32040	5 ks	10
	24078	105mm/1,45mm	4 mm 6 TPI	34040	5 ks	10
	24055	55mm	karbidová		5 ks	1

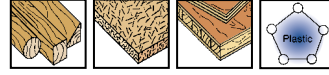
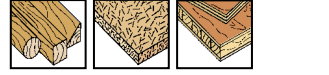
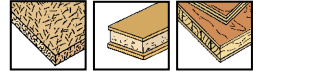
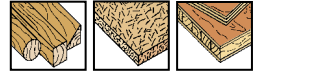
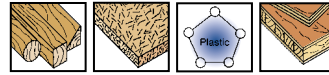
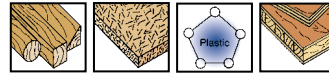
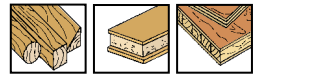
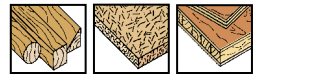
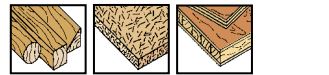
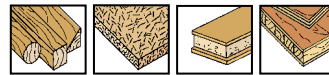
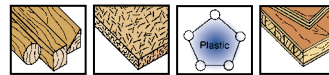
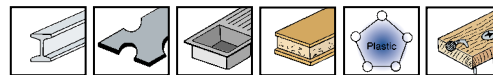
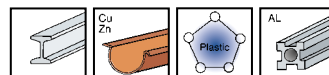
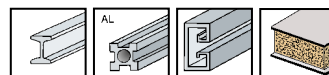
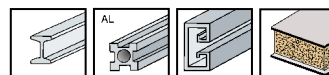
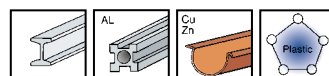
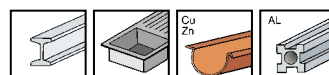
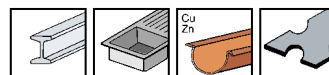
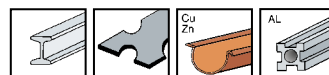

PÍLKA PRIAMOČIARA HSS - UCHYTENIE BLACK & DECKER, FERM

Číslo	Šírka	Šírka rezu	Číslo zubov	Číslo	ks	ks	Uchytienie	Uplatnenie
24080	50mm	1,0 mm	1,2 21 TPI	11012	5 ks	10		
24081	75mm	1,0 mm	3,0 8 TPI	11030	5 ks	10		
24082	75mm	1,45 mm	2,5 10 TPI	12225	5 ks	10		
24083	75mm	1,45 mm	4 6 TPI	12240	5 ks	10		
24084	75mm	1,3 mm	4 6 TPI	12340	5 ks	10		
24085	50mm	1,0 mm	2,0 13 TPI	12420	5 ks	10		
24086	75mm	1,3 mm	4,0 6 TP	12440	5 ks	10		
24087	75mm	1,45 mm	2,5 10 TPI	12625	5 ks	10		



	mäkká oceľ (S malým obsahom uhlíka)		oceľový plech		nehrdzavejúca oceľ		laminované dosky
	neželezné kovy		tvrdé a mäkké drevo		drevotrieska		plasty
	preglejka		latová preglejka		drevo s klincami		
	sendvičový materiál		dlažba a obklady		hliník		

SADA PRIAMOČIARYCH PÍLOK

5x



Č.p.	špecifikácia	ks
24045	sada	50

STOJAN PRIAMOČIARYCH PÍLOK



osadenie stojana 24098

24060	• 5 ks
24080	• 5 ks
24061	• 5 ks
24062	• 5 ks
24081	• 5 ks
24063	• 5 ks
24066	• 5 ks
24067	• 5 ks
24082	• 5 ks
24068	• 5 ks
24083	• 5 ks
24069	• 5 ks
24084	• 5 ks
24070	• 5 ks
24086	• 5 ks
24071	• 5 ks
24087	• 5 ks
24072	• 5 ks
24073	• 5 ks
24074	• 5 ks
24075	• 5 ks
24076	• 5 ks

Č.p.	špecifikácia	ks
24099	64 x 50 cm - prázdny	1
24098	64 x 50 cm - osadený	1

PÍLOVÝ PLÁTKO

FESTA®

HCS 3x

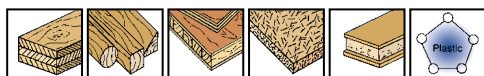

Č.p. špecifikácia
24301 150 x 19 x 1,3 mm TPI 6



PÍLOVÝ PLÁTKO

FESTA®

HCS 3x

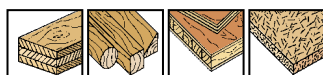

Č.p. špecifikácia
24302 225 x 19 x 1,3 mm TPI 3



PÍLOVÝ PLÁTKO

FESTA®

HCS 3x

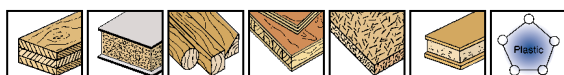

Č.p. špecifikácia
24303 200 x 19 x 1,3 mm TPI 6 - 10



PÍLOVÝ PLÁTKO

FESTA®

HCS 3x

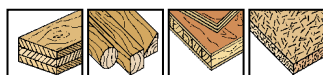

Č.p. špecifikácia
24304 240 x 19 x 1,5 mm TPI 5



PÍLOVÝ PLÁTKO

FESTA®

Bi Metal 3x

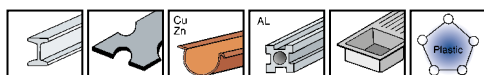

Č.p. špecifikácia
24305 150 x 19 x 1 mm TPI 24



PÍLOVÝ PLÁTKO

FESTA®

Bi Metal 3x

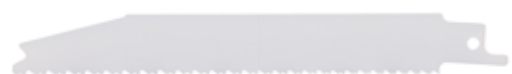
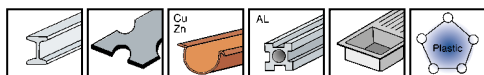

Č.p. špecifikácia
24306 150 x 19 x 1 mm TPI 9



PÍLOVÝ PLÁTKO

FESTA
Bi
Metal

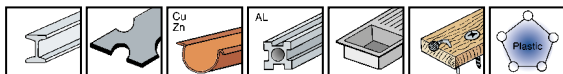
3x

Č.p.

špecifikácia

24308 225 x 19 x 1 mm TPI 10 - 14



1

PÍLOVÝ PLÁTKO

FESTA
Bi
Metal

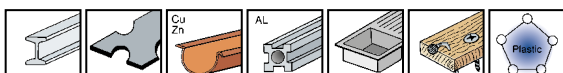
3x

Č.p.

špecifikácia

24310 150 x 22 x 1,6 mm TPI 9



1

PÍLOVÝ PLÁTKO

FESTA
Bi
Metal

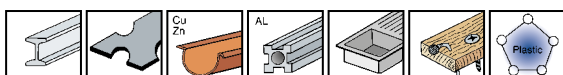
3x

Č.p.

špecifikácia

24313 225 x 22 x 1,6 mm TPI 6



1

PÍLA NA KOV HSS

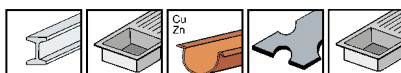
FESTA
HSS

Č.p.

špecifikácia

24050 203 x 19 x 1 mm TPI 10 - 14



25

PÍLOVÝ PLÁTKO

FESTA
TC
3x

SK zuby, dlhá životnosť

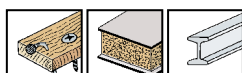

Č.p.

špecifikácia

24312 225 x 19 x 1,3 mm TPI 6 - 9



1

PÍLOVÝ PLÁTKO

FESTA
NEW
TC

Č.p.

špecifikácia

24315 305 x 50 x 1,5 mm



1

SADA PILOVÝCH PLÁTKOV

FESTA®

Bi
Metal

HCS

3x

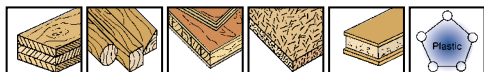

- 24301
- 24304
- 24305

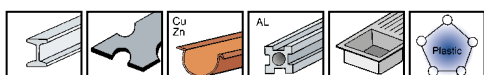
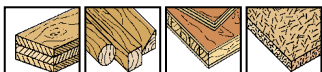

Č.p. špecifikácia

24314

1

PÍLOVÝ PLÁTOK



PÍLOVÝ PLÁTOK

FESTA®
MADE IN EU

· kalené zuby

· kalené zuby

Č.p.	špecifikácia	
24185	533 mm	1
24186	610 mm	1
24187	760 mm	1
24188	800 mm	1
24189	914 mm	1

Č.p.	špecifikácia	
24169	350 mm	10
24167	450 mm	10
24166	533 mm	10
24163	610 mm	10
24164	760 mm	10
24168	800 mm	10
24165	914 mm	10

PÍLOVÝ PLÁTOK



PÍLOVÝ PLÁTOK



Č.p.	špecifikácia	
24195	rozteč 3 mm 300 mm	1
24196	rozteč 4 mm 300 mm šikmý zub	1
24197	rozteč 5 mm 300 mm kalený zub	1
24192	pílový list do řeznické pily 450 mm	1

Č.p.	špecifikácia	
24160	rozteč 3 mm 300 mm	20
24161	rozteč 4 mm 300 mm	20
24162	rozteč 5 mm 300 mm	50

PÍLOVÝ PLÁTOK

10x



REZACIA STRUNA



Č.p.	špecifikácia	
24108	6 mm 150 mm	1

Č.p.	špecifikácia	
24120	300 mm	50

PÍLOVÝ PLÁTKO BI - METAL

FESTA



8 % COBALT



Č.p.	špecifikácia	
24180	300 mm	125

PÍLOVÝ PLÁTKO

FESTA



MOQ

Č.p.	špecifikácia		
24109	12,5 mm 300 mm	na kov	144
24118	25 mm 300 mm	na kov oboustranná	72
24119	25 mm 300 mm	na kov a dřevo	72

PÍLA NA KOV

FESTA



Č.p.	špecifikácia
24104	300 mm

6

PÍLA NA KOV

FESTA



· zesílený rám



Č.p.	špecifikácia	
24102	300 mm	6

PÍLA NA KOV

FESTA



Č.p.	špecifikácia	
24103	300 mm	6

PÍLA NA KOV



Č.p.	špecifikácia	
24153	300 mm	12

PÍLA NA KOV

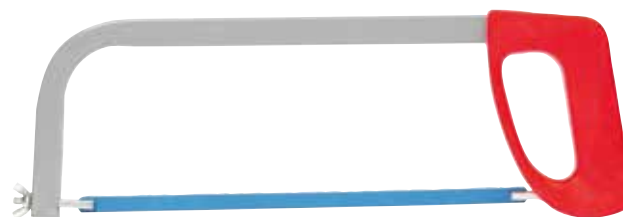

Č.p.	špecifikácia	
24100	300 mm	12

PÍLA NA KOV



Č.p. 24170
špecifikácia 300 mm

12

PÍLA NA KOV

2x

FESTA®

MADE IN EU

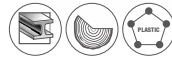

Č.p. 24126
špecifikácia 300 x 25 x 0,65 mm TPI 24 | 14

1

PÍLA NA KOV

· plátky 24108



Č.p. 24125
špecifikácia 150 mm

6

PÍLA NA KOV

· plátky 24109



Č.p. 24124
špecifikácia 260 mm

10

PÍLA

NEW



PÍLA

NEW

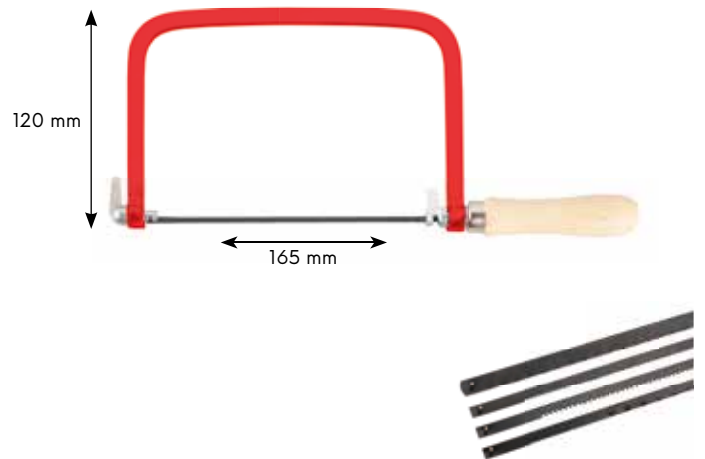

· 5x plátky

Č.p. 24121
špecifikácia 24110
pílťový plátok

1
1

Č.p. 24122
špecifikácia 24111
pílťový plátok

1
1

PÍLA CHVOSTOVKA



· 3 x brúsené a kalené zuby

Č.p.	špecifikácia	
24143	300 mm	12
24144	400 mm	12
24145	500 mm	12

PÍLA ČAPOVKA



· 3 x brúsené a kalené zuby

Č.p.	špecifikácia	
24147	300 mm	6

PÍLA DIEROVKA



· 3 x brúsené a kalené zuby

Č.p.	špecifikácia	
24149	300 mm	12

PÍLA POKOSOVÁ PROFI

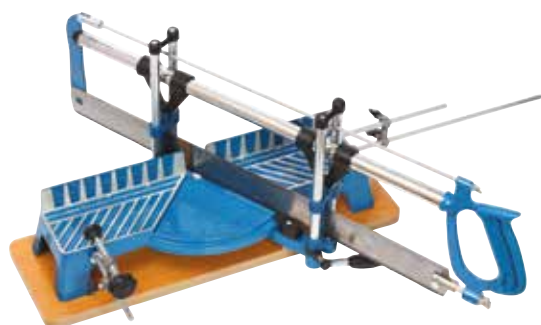

Č.p.	špecifikácia	
24130	600 mm	1
24131	600 mm, pílový plátok	1

POKOSNICA PLASTOVÁ



Č.p.	špecifikácia	
24133	300 x 140 mm	1

POKOSNICA DŘEVĚNÁ



· buk

Č.p.	špecifikácia	
24171	80 x 300 mm	10

MADE IN EU



KOSOREZ + PÍLA





Č.p.	špecifikácia	
24148	300 mm	12

PÍLA OBLÚKOVÁ

FESTA



• kalené zuby

Č.p.	špecifikácia		Č.p.	špecifikácia	
24141	450 mm	1	24136	760 mm	1
24140	533 mm	1	24142	800 mm	1
24135	610 mm	1	24137	914 mm	1

PÍLA OBLÚKOVÁ OTOČNÁ

FESTA



• kalené zuby

Č.p.	špecifikácia	
24173	350 mm	24

PÍLA ZAHRADNÁ



Č.p.	špecifikácia	
24151	300 mm	10

PÍLA ZAHRADNÁ - TULEJ



Č.p.	špecifikácia	
24154	300 mm	10

STOJAN NA REZANIE DREVA

NEW

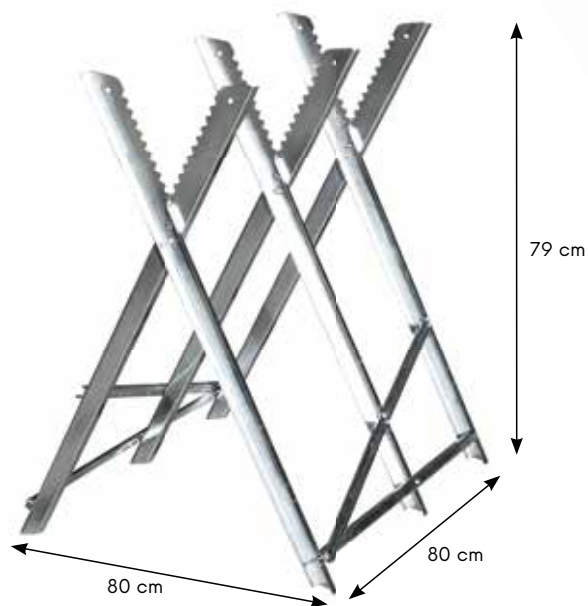

Č.p.	špecifikácia	
37570	max. 150 kg	1

PÍLA ZAHRADNÁ - OTOČNÁ

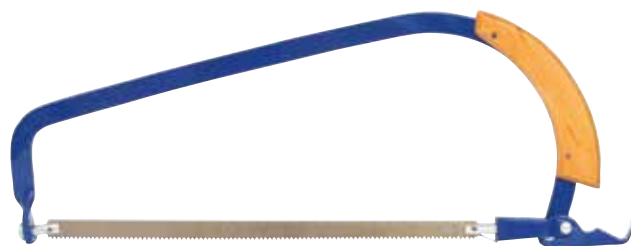

Č.p.	špecifikácia	
24150	300 mm	10

PÍLA

INOX



Č.p.	špecifikácia	
24128	450 mm plátky 24192	6

PÍLA ZATVÁRACIA



• 3 x brúsené a kalené zuby



12

Č.p. špecifikácia
45061 150 mm s krytem rukojeti

PÍLA ZATVÁRACIA



• 3 x brúsené a kalené zuby



6

Č.p. špecifikácia
45060 180 mm

PÍLA S PUZDROM



• 3 x brúsené a kalené zuby



24

Č.p. špecifikácia
45062 260 mm s puzdrom

PÍLA PROREZÁVACIA



• 3 x brúsené a kalené zuby



8

Č.p. špecifikácia
24152 350 mm 7 tpi

PÍLA TELESKOPICKÁ PROREZÁVACIA



• 3 x brúsené a kalené zuby



1

Č.p. špecifikácia
45033 230 - 490 mm

HÚSENICA S PÍLOU



Č.p.	špecifikácia	
45030	pílka 30 cm	teleskopická tyč 260 cm
45031	pílka 30 cm	

HÚSENICA



Č.p.	špecifikácia	
45032	kovová húsenica bez píly	

PÍLA NA POLYSTYREN

FESTA



Č.p.	špecifikácia	
24174	370 mm	1

PÍLA NA SADROKARTÓN

FESTA



1 2 3 · 3 x brúsené a kalené zuby



Č.p.	špecifikácia	
24159	150 mm	12

PÍLA VRTACIA NA SADROKARTÓN



Č.p.	špecifikácia	
24190	270 mm	10

PÍLA NA DUTÉ TEHLY (PORO-THERM)

FESTA



Č.p.	špecifikácia	
24181	550 mm	1

PÍLA NA PÓROBETÓN

FESTA



Č.p.	špecifikácia	
24158	22 22 SK zubů - 450 mm	5

PÍLA NA PÓROBETÓN

FESTA



Č.p.	špecifikácia	
24155	34 17 SK zubů - 630 mm	2
24156	34 34 SK zubů - 630 mm	2

PÍLA NA PÓROBETÓN

FESTA



Č.p.	špecifikácia	
24176	34 17 SK zubů - 750 mm	6
24177	34 34 SK zubů - 750 mm	6

PÍLA NA PÓROBETÓN

FESTA



· kalené zuby

Č.p.	špecifikácia	
24175	bez SK zubů - 600 mm EU	6
24178	bez SK zubů - 600 mm	6



Použitie rezných diamantových kotúčov

materiály	festa industry	plný	turbo	segment
tehla	••	••	••	••
obklady	••	•••	••	-
murivo, kameň	••	••	••	••
betón	•••	•	•••	•••
železobetón	•••	-	•••	-
strešné škridle	••	•	••	••
sklo a keramika	-	•••	-	-
mramor	•	••	•	•
žula	•••	••	•••	••
pieskovec	••	-	••	••
asfalt	-	••	-	••
kremeň	••	•	••	•

KOTUČ DIAMANTOVÝ



Č.p.	špecifikácia	
21200	Ø 115 mm 1,4 mm Ø 22,2 mm	1
21201	Ø 125 mm 1,4 mm Ø 22,2 mm	1
21204	Ø 200 mm 1,8 mm Ø 25,4 mm	1
21203	Ø 230 mm 1,8 mm Ø 22,2 mm	1



KOTUČ DIAMANTOVÝ PLNÝ



Č.p.	špecifikácia	
21210	Ø 110 mm Ø 22,2 mm	1
21211	Ø 115 mm Ø 22,2 mm	1
21212	Ø 125 mm Ø 22,2 mm	1
21215	Ø 150 mm Ø 22,2 mm	1
21218	Ø 180 mm Ø 22,2 mm	1
21219	Ø 180 mm Ø 25,4 mm	1
21220	Ø 200 mm Ø 25,4 mm	1
21223	Ø 230 mm Ø 22,2 mm	1
21224	Ø 300 mm Ø 25,4 mm	1



KOTUČ DIAMANTOVÝ SEGMENTOVÝ



Č.p.	špecifikácia	
21311	Ø 115 mm Ø 22,2 mm	1
21312	Ø 125 mm Ø 22,2 mm	1
21315	Ø 150 mm Ø 22,2 mm	1
21318	Ø 180 mm Ø 22,2 mm	1
21323	Ø 230 mm Ø 22,2 mm	1
21324	Ø 300 mm Ø 25,4 mm	1
21325	Ø 350 mm Ø 25,4 mm	1
21326	Ø 400 mm Ø 25,4 mm	1



KOTÚČ DIAMANTOVÝ TURBO

FESTO



Č.p.	špecifikácia		
21410	Ø 110 mm	Ø 22,2 mm	1
21411	Ø 115 mm	Ø 22,2 mm	1
21412	Ø 125 mm	Ø 22,2 mm	1
21415	Ø 150 mm	Ø 22,2 mm	1
21418	Ø 180 mm	Ø 22,2 mm	1
21423	Ø 230 mm	Ø 22,2 mm	1
21424	Ø 300 mm	Ø 25,4 mm	1



KOTÚČ DIAMANTOVÝ PLNÝ



Č.p.	špecifikácia		
21010	Ø 110 mm	Ø 22,2 mm	1
21011	Ø 115 mm	Ø 22,2 mm	1
21012	Ø 125 mm	Ø 22,2 mm	1
21015	Ø 150 mm	Ø 22,2 mm	1
21018	Ø 180 mm	Ø 22,2 mm	1
21023	Ø 230 mm	Ø 22,2 mm	1



KOTÚČ DIAMANTOVÝ SEGMENTOVÝ



Č.p.	špecifikácia		
21110	Ø 110 mm	Ø 22,2 mm	1
21111	Ø 115 mm	Ø 22,2 mm	1
21112	Ø 125 mm	Ø 22,2 mm	1
21115	Ø 150 mm	Ø 22,2 mm	1
21118	Ø 180 mm	Ø 22,2 mm	1
21123	Ø 230 mm	Ø 22,2 mm	1



KOTÚČ DIAMANTOVÝ TURBO



Č.p.	špecifikácia		
21130	Ø 110 mm	Ø 22,2 mm	1
21135	Ø 115 mm	Ø 22,2 mm	1
21140	Ø 125 mm	Ø 22,2 mm	1
21150	Ø 150 mm	Ø 22,2 mm	1
21180	Ø 180 mm	Ø 22,2 mm	1
21190	Ø 230 mm	Ø 22,2 mm	1



KOTÚČ DIAMANTOVÝ SEGMENTOVÝ, DVOJITÝ

FESTA

6 mm



Č.p.	špecifikácia
21195	Ø 125 x 22,2 mm

1

KOTÚČ DIAMANTOVÝ BRUSNÝ DVOJRADOVÝ

FESTA

Č.p.	špecifikácia
21430	Ø 115 mm Ø 22,2 mm
21431	Ø 125 mm Ø 22,2 mm
21432	Ø 150 mm Ø 22,2 mm

1

KOTÚČ DIAMANTOVÝ BRUSNÝ TURBO

FESTA

Č.p.	špecifikácia
21425	Ø 100 mm Ø 22,2 mm
21426	Ø 115 mm Ø 22,2 mm
21427	Ø 125 mm Ø 22,2 mm
21428	Ø 150 mm Ø 22,2 mm

1

KOTÚČ REZNÝ UNIVERZÁLNY - DIAMANTOVÝ

FESTA

Č.p.	špecifikácia
21301	Ø 125 mm Ø 22,2 mm 1,8 mm
21303	Ø 230 mm Ø 22,2 mm 1,8 mm

1

KOTÚČ REZNÝ NA KOV



Č.p.	špecifikácia	
22258	NEW Ø 115 mm Ø 22,2 mm x 0,8 mm	25
22263	Ø 115 mm Ø 22,2 mm x 1,6 mm	25
22264	Ø 115 mm Ø 22,2 mm x 2 mm	25
22259	NEW Ø 125 mm Ø 22,2 mm x 0,8 mm	25
22266	Ø 125 mm Ø 22,2 mm x 1 mm	25
22270	Ø 125 mm Ø 22,2 mm x 2 mm	25
22273	Ø 150 mm Ø 22,2 mm x 1,6 mm	25
22274	Ø 150 mm Ø 22,2 mm x 2 mm	25
22275	Ø 150 mm Ø 22,2 mm x 2,5 mm	25
22277	Ø 180 mm Ø 22,2 mm x 2 mm	25
22280	Ø 230 mm Ø 22,2 mm x 2 mm	25
22281	Ø 230 mm Ø 22,2 mm x 2,5 mm	25

KOTÚČ REZNÝ NA HLINÍK



Č.p.	špecifikácia	
22285	Ø 115 mm Ø 22,2 mm x 1 mm	1
22286	Ø 125 mm Ø 22,2 mm x 1 mm	1

KOTÚČ REZNÝ NA KOV



Č.p.	špecifikácia	
22211	Ø 115 mm Ø 22,2 mm x 1 mm	INOX 50
22212	Ø 115 mm Ø 22,2 mm x 1,2 mm	INOX 50
22225	Ø 125 mm Ø 22,2 mm x 1 mm	INOX 50
22217	Ø 125 mm Ø 22,2 mm x 1,2 mm	INOX 50
22251	Ø 115 mm Ø 22,2 mm x 1,6 mm	50
22215	Ø 115 mm Ø 22,2 mm x 2 mm	50
22216	Ø 115 mm Ø 22,2 mm x 2,5 mm	50
22252	Ø 125 mm Ø 22,2 mm x 1,6 mm	25
22218	Ø 125 mm Ø 22,2 mm x 2,5 mm	25
22219	Ø 150 mm Ø 22,2 mm x 1,2 mm	25
22253	Ø 150 mm Ø 22,2 mm x 1,6 mm	50
22220	Ø 150 mm Ø 22,2 mm x 2,5 mm	50
22254	Ø 180 mm Ø 22,2 mm x 1,6 mm	50
22222	Ø 180 mm Ø 22,2 mm x 2,5 mm	25
22255	Ø 230 mm Ø 22,2 mm x 1,6 mm	25
22224	Ø 230 mm Ø 22,2 mm x 2,5 mm	25

KOTÚČ BRUSNÝ NA KOV



Č.p.	špecifikácia	
22240	Ø 115 mm Ø 22,2 mm x 6,4 mm	25
22242	Ø 125 mm Ø 22,2 mm x 6,4 mm	25
22244	Ø 150 mm Ø 22,2 mm x 6,4 mm	25
22246	Ø 180 mm Ø 22,2 mm x 6,4 mm	25
22248	Ø 230 mm Ø 22,2 mm x 6,4 mm	25

KOTÚČ REZNÝ NA KAMENĚ



Č.p.	špecifikácia	
22294	Ø 230 mm Ø 22,2 mm x 3 mm	1

KOTÚČ REZNÝ NA KAMENĚ



Č.p.	špecifikácia	
22230	Ø 115 mm Ø 22,2 mm x 2,5 mm	50
22232	Ø 125 mm Ø 22,2 mm x 2,5 mm	50
22234	Ø 150 mm Ø 22,2 mm x 2,5 mm	25
22236	Ø 180 mm Ø 22,2 mm x 2,5 mm	25
22238	Ø 230 mm Ø 22,2 mm x 2,5 mm	25

KOTÚČ REZNÝ NA KOV - DIAMANTOVÝ



Č.p.	špecifikácia	
21306	Ø 125 mm Ø 22,2 mm 1,3 mm	1
21308	Ø 230 mm Ø 22,2 mm 1,8 mm	1

KOTÚČ REZNÝ UNIVERZÁLNY - KARBIDOVÝ



Č.p.	špecifikácia	
21192	Ø 125 mm Ø 22,2 mm	1
21194	Ø 230 mm Ø 22,2 mm	1

KOTÚČ LAMELOVÝ

FESTA®

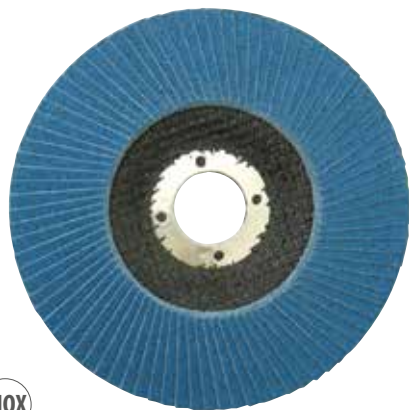

· brusný kotúč pre brúsenie nerezovej ocele

Č.p.	špecifikácia	hrúbka	
22140	Ø 115 mm Ø 22,2 mm	P40	5
22141	Ø 115 mm Ø 22,2 mm	P60	5
22142	Ø 115 mm Ø 22,2 mm	P80	5
22143	Ø 115 mm Ø 22,2 mm	P100	5
22145	Ø 125 mm Ø 22,2 mm	P40	5
22146	Ø 125 mm Ø 22,2 mm	P60	5
22147	Ø 125 mm Ø 22,2 mm	P80	5
22148	Ø 125 mm Ø 22,2 mm	P100	5
22150	Ø 150 mm Ø 22,2 mm	P40	5
22151	Ø 150 mm Ø 22,2 mm	P60	5
22155	Ø 150 mm Ø 22,2 mm	P80	5
22156	Ø 150 mm Ø 22,2 mm	P100	5



KOTÚČ LAMELOVÝ



Č.p.	špecifikácia	hrúbka	
21780	Ø 115 mm Ø 22,2 mm	P40	10
21781	Ø 115 mm Ø 22,2 mm	P60	10
21782	Ø 115 mm Ø 22,2 mm	P80	10
21783	Ø 115 mm Ø 22,2 mm	P100	10
21784	Ø 115 mm Ø 22,2 mm	P120	10
21786	Ø 125 mm Ø 22,2 mm	P40	10
21787	Ø 125 mm Ø 22,2 mm	P60	10
21788	Ø 125 mm Ø 22,2 mm	P80	10
21789	Ø 125 mm Ø 22,2 mm	P100	10
21790	Ø 125 mm Ø 22,2 mm	P120	10
21792	Ø 150 mm Ø 22,2 mm	P40	10
21793	Ø 150 mm Ø 22,2 mm	P60	10
21794	Ø 150 mm Ø 22,2 mm	P80	10
21795	Ø 150 mm Ø 22,2 mm	P100	10
21796	Ø 150 mm Ø 22,2 mm	P120	10



KOTÚČ NYLON S PODLOŽKOU



NEW



Č.p.	špecifikácia	
21798	Ø 125 mm Ø 22,2 mm	1

KOTÚČ RAŠPLOVÝ - STŘEDNĚ HRUBÝ

FESTA

NEW



Č.p.	špecifikácia			
21802	Ø 125 mm	Ø 22,2 mm	3 mm	1

KOTÚČ RAŠPLOVÝ - HRUBÝ

FESTA

NEW



Č.p.	špecifikácia			
21801	Ø 125 mm	Ø 22,2 mm	3 mm	1

KOTÚČ NA DREVO S OTVORY

FESTA



• brusný kotúč pre brúsenie dreva

Č.p.	špecifikácia			
21800	Ø 125 mm	Ø 22,2 mm		1



212

MURÁRSKE HLADÍTKA, LYŽICE, ŠPACHTLE



222

ŠKRABÁKY A BRÚSNA HLADIDLA



225

HLADÍTKA A BRÚSNE MRIEŽKY



227

HLADÍTKA PRE ÚPRAVU OMIETOK



233

MURÁRSKE NABERAČKY



234

MIEŠADLA



238

PREDLŽOVACIE KÁBLE



239

ELEKTRICKÉ A PLYNOVÉ OHRIEVAČE



240

STAVEBNÉ MIEŠAČKY



244

ZHADZOVANÍ STAVEBNEJ SUTINY



244

STAVEBNÉ KOLIESKA



245

LAMAČE DLAŽBY A NOSIČE OBRUBNÍKOV

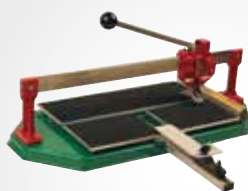

247

REZAČKY DLAŽBY



250

POMÔCKY PRE POKLADANIE DLAŽBY



253

NIVELÁCIA



257

REZAČKY NA POLYSTYRÉN



261

OMIETAČKY



263

PB HORÁKY A REGULÁTORY TLAKU



267

MURÁRSKE NÁDOBY



268

VRECIA NA SUŠ A ODPAD



269

LEPIACE A MASKOVACIE PÁSKY

STAVEBNÉ NÁRADIE 210 - 291



273

VYTLAČOVACIE PIŠTOĽE



275

PIŠTOĽE NA PU PENU



276

TEPLOVZDUŠNÉ A TAVNÉ PIŠTOĽE



278

MALIARSKÉ POTREBY



284

PE PLACHTY



286

KARABÍNY, REŤAZE A OCEĽOVÉ LANÁ



289

STAVEBNÉ SVETLÁ



290

REBRÍKY



290

DVIERKA KOMÍNOVÉ A DEBNIACE STOJKY



HLADIDLA, LYŽICE A ŠPACHTLE

HLADIDLO NEREZ 280 X 130 MM

INOX

· gumová rukoväť

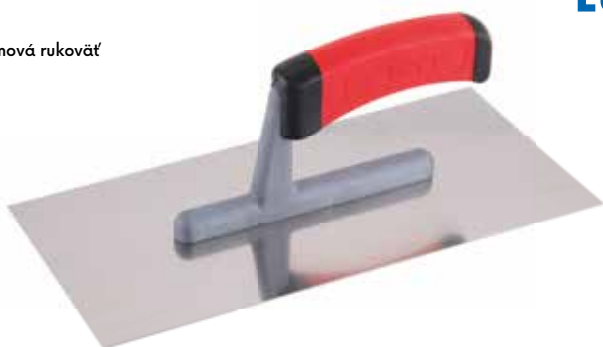

Č.p. 31140 špecifikácia rovné



10

FESTA
MADE IN EU

HLADIDLO NEREZ 280 X 130 MM

INOX

· gumová rukoväť



Č.p. 31148 špecifikácia rovné s oblými rohmi



10

FESTA
MADE IN EU

HLADIDLO NEREZ 280 X 130 MM ZUBOVÉ

INOX

· gumová rukoväť



Č.p. 31146 špecifikácia Ø 16



10



FESTA
MADE IN EU

HLADIDLO NEREZ 280 X 130 MM ZUBOVÉ

INOX

· gumová rukoväť



Č.p.	špecifikácia		Č.p.	špecifikácia	
31141	e 4	10	31144	e 10	10
31142	e 6	10	31145	e 12	10
31143	e 8	10			

FESTA
MADE IN EU

HLADIDLO NEREZ 280 X 130 MM ZUBOVÉ

INOX



Č.p.	špecifikácia	
31101	e 4	10
31111	e 6	10
31121	e 8	10

FESTA
MADE IN EU

HLADIDLO NEREZ 280 X 130 MM

INOX



Č.p. 31091 špecifikácia rovné



10

FESTA
MADE IN EU

HLADIDLO NEREZ 280 X 130 MM

INOX

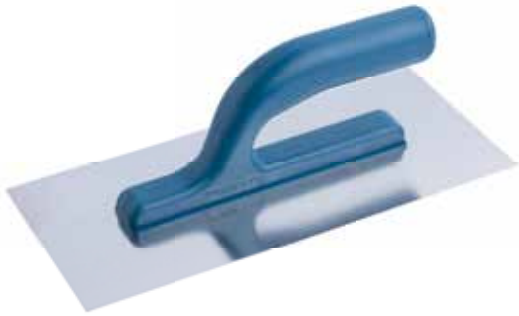

Č.p.	špecifikácia	
31011	rovné	10

HLADIDLO NEREZ 280 X 130 MM ZUBOVÉ

INOX



Č.p.	špecifikácia		Č.p.	špecifikácia	
31021	e 4	10	31051	e 10	10
31031	e 6	10	31053	e 12	10
31041	e 8	10			

HLADIDLO NEREZ 270 X 125 MM

INOX



Č.p.	špecifikácia	
31005	rovné	25

HLADIDLO NEREZ 270 X 125 MM ZUBOVÉ

INOX



Č.p.	špecifikácia		Č.p.	špecifikácia	
31006	e 4	24	31008	e 8	24
31007	e 6	24	31009	e 10	24

HLADIDLO NEREZ 360 X 130 MM

INOX



Č.p.	špecifikácia	
31151	rovné	10

HLADIDLO NEREZ 360 X 130 MM

INOX



Č.p.	špecifikácia	
31150	rovné	10

HLADIDLO NEREZ 480 X 130 MM

INOX



Č.p.	špecifikácia	
31082	rovné	10

HLADIDLO NEREZ 680 X 130 MM

INOX



Č.p.	špecifikácia	
31155	rovné	10

HLADIDLO NEREZ 500 X 130 MM

FESTA®

INOX



Č.p.	špecifikácia	
31081	rovné	10

HLADIDLO NEREZ 500 X 130 MM ZUBOVÉ

FESTA®

INOX



Č.p.	špecifikácia	
31052	e 4	10
31061	e 6	10
31062	e 8	10
31071	e 10	10
31072	e 12	10

LYŽICA NEREZ

FESTA®

INOX

· gumová rukoväť



Č.p.	špecifikácia		Č.p.	špecifikácia	
31232	120 mm	10	31234	160 mm	10
31233	140 mm	10	31235	180 mm	10

LYŽICA NEREZ

FESTA®

INOX



Č.p.	špecifikácia		Č.p.	špecifikácia	
31220	120 x 80 mm	10	31222	160 x 115 mm	10
31221	140 x 80 mm	10	31231	180 x 120 mm	10

LYŽICA NEREZ OBLÁ

FESTA®

INOX

· gumová rukoväť



Č.p.	špecifikácia	
31334	160 x 100 mm	10

LYŽICA NEREZ OBLÁ

FESTA®

INOX



Č.p.	špecifikácia	
31343	160 x 100 mm	10

LYŽICA NEREZ VYMAZÁVACIA

FESTA®

INOX

· gumová rukoväť



Č.p.	špecifikácia		Č.p.	špecifikácia	
31360	40 mm	10	31400	100 mm	10
31380	60 mm	10	31403	120 mm	10
31390	80 mm	10			

LYŽICA NEREZ VYMAZÁVACIA

FESTA®

INOX



Č.p.	špecifikácia		Č.p.	špecifikácia	
31362	40 mm	10	31392	80 mm	10
31382	60 mm	10	31402	100 mm	10
			31404	120 mm	10

LYŽICA NEREZ MAČACÍ JAZYK

FESTA

INOX

· gumová rukoväť



Č.p.	špecifikácia	
31330	140 x 50 mm	10
31340	160 x 60 mm	10

LYŽICA NEREZ MAČACÍ JAZYK

FESTA

INOX



Č.p.	špecifikácia	
31332	140 x 50 mm	10
31341	160 x 60 mm	10

LYŽICA NEREZ KÚTOVÁ

FESTA

INOX

· gumová rukoväť



Č.p.	špecifikácia	
31280	80 x 60 x 60 mm	10

LŽICE NEREZ KÚTOVÁ

FESTA

INOX



Č.p.	špecifikácia	
31281	80 x 60 x 60 mm	10

LYŽICA NEREZ ROHOVÁ

FESTA

INOX

· gumová rukoväť



Č.p.	špecifikácia	
31270	80 x 60 x 60 mm	10

LYŽICA NEREZ ROHOVÁ

FESTA

INOX



Č.p.	špecifikácia	
31271	80 x 60 x 60 mm	10

LYŽICA NEREZ POKRÝVAČSKÁ

FESTA

INOX

· gumová rukoväť



Č.p.	špecifikácia	
31320	140 x 75 mm	10

LYŽICA NEREZ POKRÝVAČSKÁ

FESTA

INOX



Č.p.	špecifikácia	
31322	140 x 75 mm	10

LŽÍCE NEREZ ZUBOVÁ S HRANOU

FESTA

INOX



Č.p.	špecifikácia		
31218	180 mm e 6		12

ŠPACHTĽA NEREZ

FESTA

INOX

- gumová rukoväť



Č.p.	špecifikácia		Č.p.	špecifikácia	
31510	40 mm	10	31513	100 mm	10
31511	60 mm	10	31514	120 mm	10
31512	80 mm	10	31515	140 mm	10

ŠPACHTĽA NEREZ

FESTA

INOX



Č.p.	špecifikácia		Č.p.	špecifikácia	
31461	40 mm	12	31491	100 mm	12
31471	60 mm	12	31467	120 mm	12
31481	80 mm	12	31468	140 mm	12

ŠPACHTĽA ŠKRABACIA NEREZ

FESTA

INOX

- gumová rukoväť



- zosilnená čepeľ

Č.p.	špecifikácia	
32173	75 mm	10

ŠPACHTĽA ŠKRABACIA NEREZ S TULEJOU

INOX



- zosilnená čepeľ
- vhodná násada 52010

Č.p.	špecifikácia	
32170	100 mm	12

ŠPACHTĽA NEREZ S BITOM

FESTA

INOX

- gumová rukoväť



Č.p.	špecifikácia	
31455	150 mm	12
31456	200 mm	12

ŠPACHTĽA NEREZ

FESTA

INOX



Č.p.	špecifikácia	
31498	150 mm	12
31499	200 mm	12
31500	100 mm	12



ŠPACHTĽA NEREZ PRE CELOPLOŠNÉ TMELENIE

FESTA
INOX

Č.p.	špecifikácia	
31555	35 cm	1
31556	45 cm	1
31557	60 cm	1

Č.p.	špecifikácia	
31558	80 cm	1
31559	100 cm	1

STIERKA NEREZ S VÝSTUŽOU

FESTA
INOX

• gumová rukoväť



Č.p.	špecifikácia	
31505	200 mm	5
31506	250 mm	5
31507	300 mm	5

STIERKA NEREZ

INOX
MADE IN EU

Č.p.	špecifikácia	
31541	250 mm	1
31551	250 mm úzka	1

STIERKA NEREZ S VÝSTUŽOU

MADE IN EU
NEW
INOX

Č.p.	špecifikácia	
31520	400 mm	1
31521	500 mm	
31522	600 mm	

STIERKA NEREZ S VÝSTUŽOU-PRÍSLUŠENSTVO

MADE IN EU
NEW

Č.p.	špecifikácia	
31523	držiak ALU	1
31524	držiak plastic	1
31525	držiak KULOGRIF	1
31526	násada drevená s kovovým vnútorným závitom - 130cm	1

ŠPACHTĽA NEREZ



INOX



Č.p.	špecifikácia	
31493	40 mm	20
31494	60 mm	20
31495	80 mm	20
31496	100 mm	20

STIERKA NEREZ FASÁDNA

FESTA

INOX



Č.p.	špecifikácia	
31552	400 mm	10
31553	600 mm	10

ŠPACHTĽA NEREZ MALIARSKA

FESTA

INOX



Č.p.	špecifikácia	
31497	63 x 195 mm	12

NŮŽ NEREZ TAPETÁRSKÝ

FESTA

INOX



Č.p.	špecifikácia	
31503	150 mm	12

ŠPACHTĽA ŠKRABACIA MALIARSKA



INOX



Č.p.	špecifikácia	
31501	100 mm	30
31502	náhradný brit	1

ŠPACHTĽA PRE SADROKARTONÁROV



Č.p.	špecifikácia	
34308	50 mm	20
34307	80 mm	12
34306	100 mm	10
34305	150 mm	12

STIERKA JAPONSKÁ

FESTA

4x

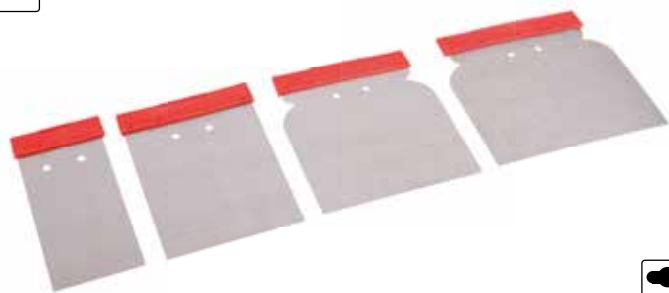

Č.p.	špecifikácia	
31452	nerez 50, 80, 100, 120 mm	10
31453	ocel' 50, 80, 100, 120 mm	10

STIERKA JAPONSKÁ, PLAST

FESTA



4x



Č.p.	špecifikácia	
31454	50, 80, 100, 120 mm	12

HLADIDLO OCEĽOVÉ

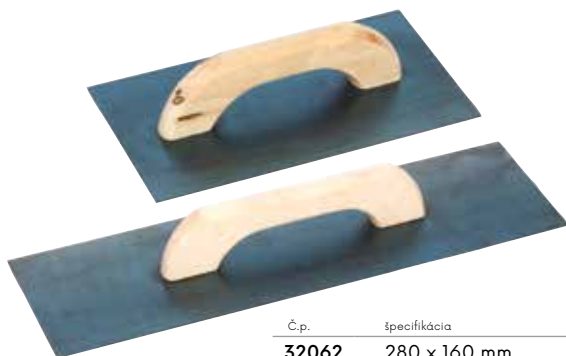

Č.p.	špecifikácia	
32062	280 x 160 mm	10
32076	400 x 100 mm	36
32060	500 x 140 mm	5

HLADIDLO OCEĽOVÉ ŠPICATÉ



Č.p.	špecifikácia	
32064	500 x 90 mm	5
32066	550 x 140 mm	5

LYŽICA OCEĽOVÁ BRÚSENÁ



Č.p.	špecifikácia	
32015	160 x 130 mm	10
32014	180 x 130 mm	10
32016	200 x 140 mm	10

LYŽICA OCEĽOVÁ



Č.p.	špecifikácia	
32001	160 x 110 mm	10
32002	160 x 130 mm	10
32003	180 x 130 mm	10
32013	200 x 140 mm	10

LYŽICA OCEĽOVÁ OBLÁ



Č.p.	špecifikácia	
32018	160 x 110 mm	10

LYŽICA OCEĽOVÁ VYMAZÁVACIA



Č.p.	špecifikácia	
32024	140 x 80 mm	12

LYŽICA OCEĽOVÁ MAČACÍ JAZYK



Č.p.	špecifikácia	
32020	140 x 65 mm	12
32021	140 x 40 mm	12

LYŽICA OCEĽOVÁ POKRÝVAČSKÁ





Č.p.	špecifikácia	
32026	140 x 85 mm	12

ŠPACHTĽA OCEĽOVÁ



FESTA



Č.p.	špecifikácia		Č.p.	špecifikácia	
32161	30 mm	10	32171	90 mm	10
32162	40 mm	10	32166	100 mm	10
32163	50 mm	10	32172	110 mm	10
32164	60 mm	10	32167	120 mm	10
32169	70 mm	10	32168	140 mm	10
32165	80 mm	10			

ŠPACHTĽA OCEĽOVÁ



Č.p.	špecifikácia		Č.p.	špecifikácia	
32176	30 mm	12	32216	80 mm	12
32186	40 mm	12	32226	100 mm	12
32196	50 mm	12	32234	125 mm	12
32206	60 mm	12			

ŠPACHTĽA ŠKRABACIA NA STENY A PODLAHY

FESTA

INOX



· zosilnená čepeľ

Č.p.	šírka	dĺžka	
32174	100 mm	500 mm	1

SADA ŠPACHTLÍ OCEĽOVÝCH

3x



Č.p.	špecifikácia	
32240	30, 50, 80 mm	10



STIERKA OCEĽOVÁ



Č.p.	špecifikácia	
31601	180 mm - rovná	1
31602	NEW 180mm A1	1
31603	NEW 180mm A2	1
31641	180 mm - e4	1

STIERKA OCEĽOVÁ



Č.p.	špecifikácia	
31655	250 mm - e4	1
31651	250 mm - rovná	1

STIERKA PLASTOVÁ ZUBOVÁ

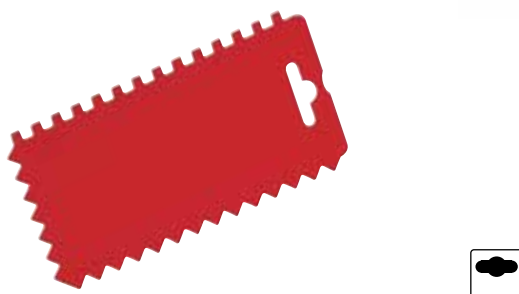

Č.p.	špecifikácia	
37101	150 x 80 mm	100
37111	170 x 115 mm	100

STIERKA PLASTOVÁ



Č.p.	špecifikácia	
37051	rovná	1
37031	zub - 4 x 6 mm	1
37041	zub - 6 x 6 mm	1

LYŽICA OCEĽOVÁ MODELOVACIA



Č.p.	špecifikácia	
32022	140 x 80 mm	12
32023	125 x 40 mm	12

ŠPÁROVAČKA JEDNOSTRANNÁ



Č.p.	špecifikácia	
32040	10 mm	20
32041	12 mm	20
32042	15 mm	20
32043	18 mm	20
32044	20 mm	20

ŠPÁROVAČKA OBOJSTRANNÁ



Č.p.	špecifikácia	
32050	10 12 mm	50
32051	10 15 mm	50
32052	10 18 mm	50
32053	15 20 mm	50

DRÁŽKOVAC NA YTONG



Č.p.	špecifikácia	
32037	600 mm	1

ŠKRABÁK NA YTONG

FESTA



· topol'

MOQ
2

Č.p.	špecifikácia
32317	450 x 95 mm

ŠKRABÁK NA YTONG - JEMNÝ ZUB

FESTA



· topol'

MOQ
2

Č.p.	špecifikácia
32312	450 x 95 mm

ŠKRABÁK NA YTONG

FESTA



· topol'

MOQ
2

Č.p.	špecifikácia
32337	260 x 95 mm

ŠKRABÁK NA YTONG

FESTA



· topol'

MOQ
2

Č.p.	špecifikácia
32327	230 x 145 mm

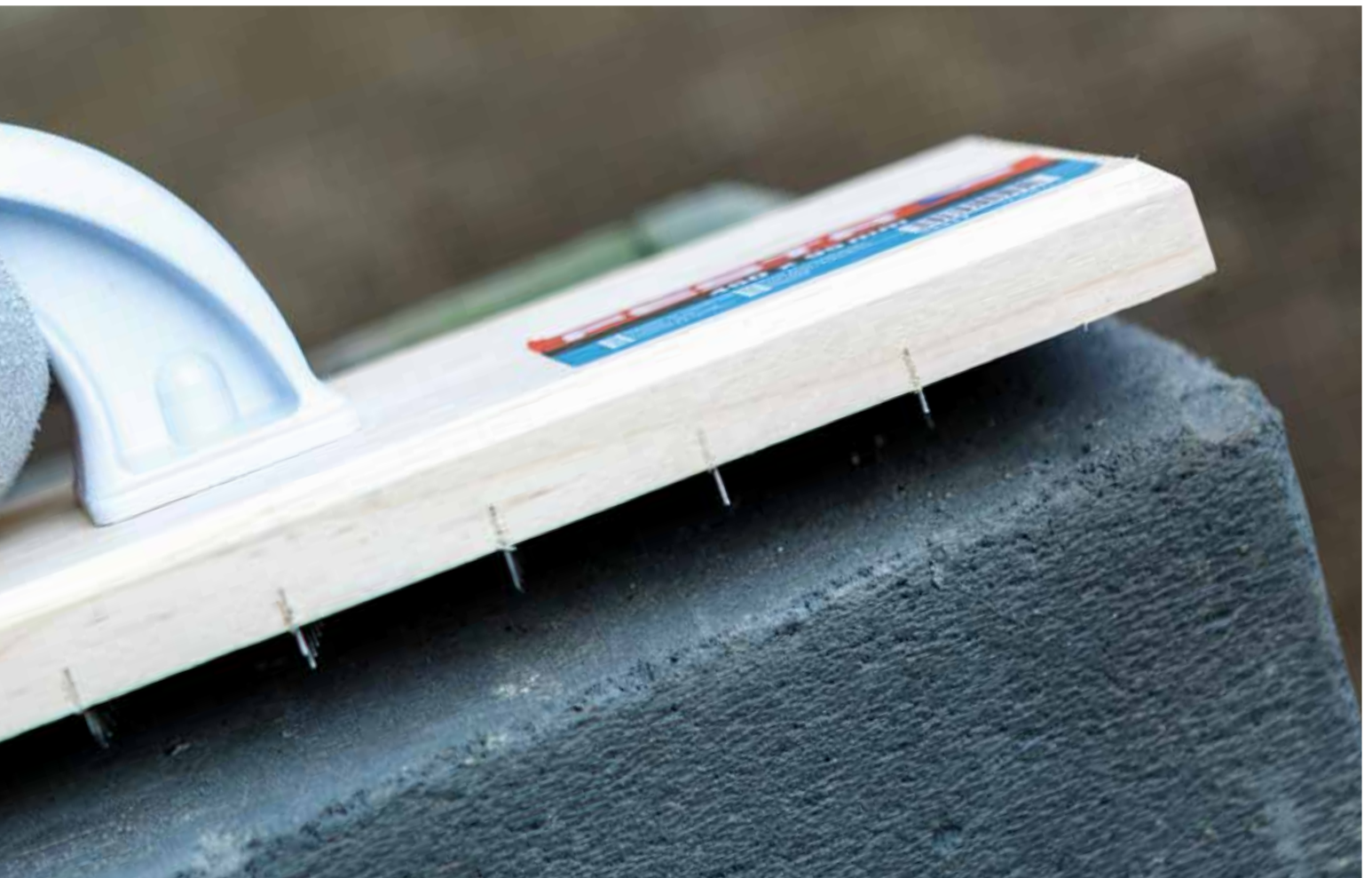

ŠKRABÁK NA STARÉ OMIETKY



MOQ
2

Č.p.	špecifikácia
32314	400 x 180 mm

2

ŠKRABÁK NA STARÉ OMIETKY



MOQ
2

Č.p.	špecifikácia
32329	270 x 130 mm

2

ŠKRABÁK NA STARÉ OMIETKY S OTVORMI



MOQ
2

Č.p.	špecifikácia
33168	380 x 160 mm

2

ŠKRABÁK NA STARÉ OMIETKY



MOQ
2

Č.p.	špecifikácia
32320	400 x 180 mm

2

HLADIDLO BRÚSNE NA POLYSTYRÉN



MOQ
2

Č.p.	špecifikácia
32418	400 x 180 mm hr. 16
32421	400 x 180 mm hr. 16 brusný papier

2
 10

HLADIDLO BRÚSNE NA POLYSTYRÉN



MOQ
2

Č.p.	špecifikácia
32318	400 x 180 mm
32319	500 x 250 mm
32321	400 x 180 mm hr. 16 brusný papier
32322	500 x 250 mm hr. 16 brusný papier

2
 2
 10
 10

HLADIDLO BRÚSNE NA POLYSTYRÉN



MOQ
2

Č.p.	špecifikácia
32324	270 x 130 mm hr. 16
32323	270 x 130 mm hr. 16 brusný papier

2
 10

HLADIDLO BRÚSNE S LEPENÝM BRUSIVOM



MOQ
2

Č.p.	špecifikácia
32330	400 x 180 mm
32331	270 x 130 mm

2
 2

ŠKRABÁK PLECHOVÝ NA KAMENNÚ MINERÁLNU VLNU

MADE IN
EU

Zn

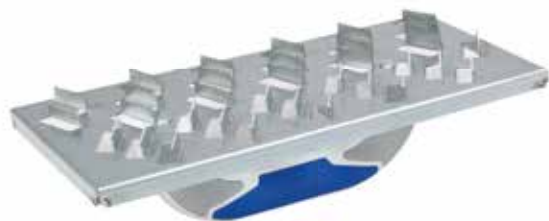
MOQ
2

Č.p.	špecifikácia
32328	285 x 145 mm

10

ŠKRABÁK PLECHOVÝ

FESTA
MADE IN
EUMOQ
2

Č.p.	špecifikácia
32325	225 x 105 mm

2

ŠKRABÁK MREŽKOVÝ

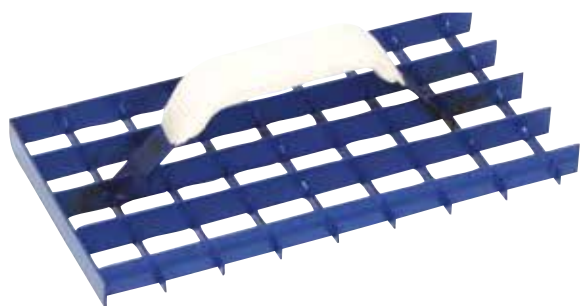
MOQ
2

Č.p.	špecifikácia
32316	280 x 150 mm

20

ŠKRABÁK MREŽKOVÝ OZUBENÝ

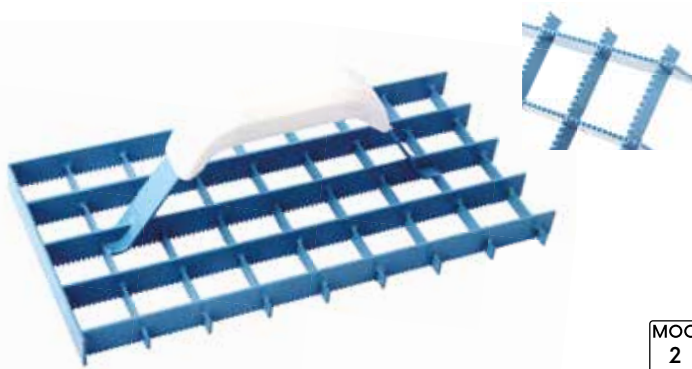
MOQ
2

Č.p.	špecifikácia
32335	290 x 145 mm

2

ŠKRABÁK

ALU



· 8 britov

MOQ
2

Č.p.	špecifikácia
32326	450 x 90 mm

20

ŠKRABÁK



· 6 britov

MOQ
2

Č.p.	špecifikácia
32315	270 x 90 mm

30

HLADIDLO PLASTOVÉ

FESTA
MADE IN
EU

Č.p.	špecifikácia
34027	400 x 180 mm

20

HLADIDLO PLASTOVÉ BEZ POVRCHU

FESTA
MADE IN
EU

Č.p.	špecifikácia	
30003	270 x 125 mm	28
30004	235 x 115 mm	35
30005	210 x 115 mm	38
30007	210 x 60 mm	44

HLADIDLO DREVENÉ

FESTA

· lipové drevo

Č.p.	špecifikácia	
34005	400 x 145 mm	40
34007	290 x 145 mm	20

HLADIDLO DREVENÉ



· topoľové drevo

Č.p.	špecifikácia	
34006	400 x 145 mm	40

HLADIDLO ABS



Č.p.	špecifikácia	
34041	280 x 140 - 2 mm	10
34051	280 x 140 - 3 mm	10
34053	280 x 140 - 3 mm zubové - e6	10

HLADIACA DOSKA NA BETÓN



Č.p.	špecifikácia	
15889	980 x 380 mm násada Ø 32 mm	1

STIERKA S GUMOU



Č.p.	špecifikácia	
15886	450 mm násada Ø 23 mm	48
15887	600 mm násada Ø 23 mm	48
15888	750 mm násada Ø 23 mm	32

ŠTAHOVACIA DOSKA



Č.p.	špecifikácia	
15885	100 x 800 mm násada Ø 32 mm	1

HLADIDLO POLYURETAN



HLADIDLO POLYSTYREN

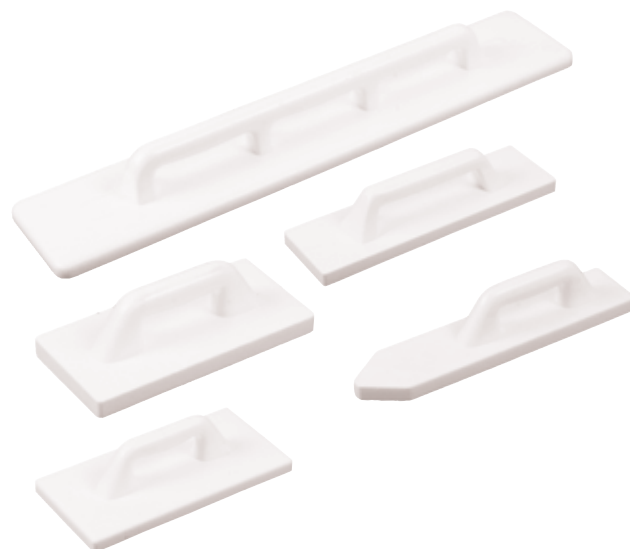

Č.p.	špecifikácia	
34122	120 x 240 mm	50
34132	140 x 280 mm	40
34142	180 x 320 mm	25
34152	200 x 360 mm	20
34121	80 x 260 mm skosené	50
34153	100 x 400 mm	30

Č.p.	špecifikácia	
34154	220 x 420 mm	15
34155	240 x 480 mm	15
34156	280 x 500 mm	10
34157	330 x 330 mm	5
34158	120 x 800 mm	5
34159	120 x 1000 mm	5
34160	120 x 1200 mm	5

Č.p.	špecifikácia	
34101	80 x 350 mm skosené	10
34061	130 x 270 mm	10
34111	170 x 320 mm	10
34071	130 x 450 mm	10
34081	140 x 750 mm	10
34091	140 x 900 mm	5

HLADIDLO POLYURETAN



HLADIDLO NA BRÚSNU MRIEŽKU

HLADIDLO NA BRÚSNU MRIEŽKU

FESTA

Č.p.	špecifikácia	
34115	140 x 280 mm	36
34116	180 x 320 mm	36
34117	200 x 360 mm	24
34118	220 x 420 mm	24
34119	240 x 480 mm	24

Č.p.	špecifikácia	
34301	230 x 105 mm	1
34304	235 x 80 mm	1

Č.p.	špecifikácia	
34200	210 x 115 mm	30
34201	240 x 105 mm	50
34202	240 x 80 mm	50

HLADIDLO NA NÁSADU NA BRÚSNU MRIEŽKU

ALU

MRIEŽKA BRÚSNA SADA

10x

MRIEŽKA BRÚSNA SADA

3x

násada 52030

Č.p.	špecifikácia	
34203	230 x 80 mm aluminium	1
52030	teleskopická násada	12

Č.p.	špecifikácia	
34271	115 x 290 mm zrn. 120	80
34272	115 x 290 mm zrn. 100	80
34273	115 x 290 mm zrn. 80	80
34274	93 x 290 mm zrn. 120	80
34275	93 x 290 mm zrn. 100	80
34276	93 x 290 mm zrn. 80	80

Č.p.	špecifikácia	
34280	115 x 290 mm zrn. 120	20
34281	115 x 290 mm zrn. 100	20
34282	115 x 290 mm zrn. 80	20
34283	93 x 290 mm zrn. 120	20
34284	93 x 290 mm zrn. 100	20
34285	93 x 290 mm zrn. 80	20

MATERIÁL POVRCH	BETÓN		OMIETKA			LEPIDLO A ŠKÁROVACIE HMOTY	FASÁDNE LEPIDLO	POUŽITIE
	HRUBÝ	POTEROVÝ	JADROVÁ	JEMNÁ VNÚTORNÁ	JEMNÁ YTONG			
ČIERNA PLSŤ (HNEDÁ, SIVÁ)				••••		••		vyrovnanie jemnej omietky, na väčšie zrno omietok
BIELA PLSŤ				••••	••••	••••		vyrovnanie jemnej omietky, na jemnejšie zrno omietok
MOLITAN JEMNÝ				••••	••••	••••		odstránenie voľného piesku, na jemný štuk (keraštuk), na umytie obkladov po spárovaní
MOLITAN HRUBÝ				••••	••••	••••		odstránenie voľného piesku, na hrubý štuk
MOLITAN RASTROVANÝ				••••	••••	••••		odstránenie voľného piesku, vďaka rastrovaniu lepšie zachytí hrubé časti štku, na umytie po spárovaní
MORSKÁ HUBA					•••	••••		umytie škárovacej hmoty
HYDRO HUBA HRUBÁ, JEMNÁ					•	••••		umytie škárovacej hmoty
HUBA				••	••••	••	••••	umytie škárovacej hmoty, dočistenie jemnej omietky, vyhladenie štukových omietok
MIKROPRYŽ							••••	zatlačenie škárovacej hmoty do škáry
GUMOVÁ PENA							••••	zatlačenie škárovacej hmoty do škáry
MIRELON		••••	•••					spracovanie betónu, zapucovanie jadra
DUREN				••••	••	••••		vyrovnanie jemnej omietky, všeobecne na dokončenie štukových omietok
DREVO	••••	••••	••••					spracovanie betónu, zapucovanie jadra
OCEĽOVÝ PLECH	••	••••		••		••••	••	glejtovanie betónu, nedostupné miesta
POLYSTYRÉN	•••	••••	•••	••		••		spracovanie betónu, zapucovanie jadra
POLYURETÁN	••••	••••	••••					spracovanie betónu, zapucovanie jadra
ABS		••		••••	••••	••••	••••	škrabanie a točenie omietky, nanášanie lepidla, omietok a štukov, ťahovanie jemné, špalety
NEREZ HLADKÉ				••••	••••	••••	••••	ťahovanie jemné, nanášanie lepidiel, omietok a štukov, ťahovanie fasádneho lepidla
NEREZ ZUBATÉ							••••	ťahovanie lepidla na obklady a dlažbu
BRÚSNE HĽADIDLO NA POLYSTYRÉN, PLASTOVÉ			••				••••	brúsenie polystyrénu, brúsenie cementového lepidla
BRÚSNE HĽADIDLO NA POLYSTYRÉN, PREGLEJKOVÉ			••				••••	brúsenie fasádneho polystyrénu, brúsenie cementového lepidla

HLADIDLO PLASTOVÉ BIELA PLŠŤ



NÁHRADNÝ POVRCH - BIELA PLŠŤ



Č.p.	špecifikácia		Č.p.	špecifikácia	
34400	280 x 140 x 8 mm	15	34450	220 x 130 x 8 mm	15
34415	250 x 130 x 8 mm	15	34445	220 x 70 x 8 mm	20

Č.p.	špecifikácia		Č.p.	špecifikácia	
34241	280 x 140 x 8 mm	1	34460	220 x 130 x 8 mm	1
34223	250 x 130 x 8 mm	1	34475	220 x 70 x 8 mm	1

HLADIDLO PLASTOVÉ PLŠŤ ČIERNA



NÁHRADNÝ POVRCH - ČIERNA PLŠŤ



Č.p.	špecifikácia		Č.p.	špecifikácia	
34401	280 x 140 x 10 mm	15	34451	220 x 130 x 10 mm	15
34416	250 x 130 x 10 mm	15	34446	220 x 70 x 10 mm	20

Č.p.	špecifikácia		Č.p.	špecifikácia	
34243	280 x 140 x 10 mm	1	34461	220 x 130 x 10 mm	1
34221	250 x 130 x 10 mm	1	34476	220 x 70 x 10 mm	1

HLADIDLO PLASTOVÉ S HRUBOU HUBOU



NÁHRADNÝ POVRCH - HRUBÁ HUBA



Č.p.	špecifikácia		Č.p.	špecifikácia	
34441	280 x 140 x 12 mm	15	34473	280 x 140 x 12 mm	1
34440	250 x 130 x 12 mm	15	34472	250 x 130 x 12 mm	1

Č.p.	špecifikácia		Č.p.	špecifikácia	
34473	280 x 140 x 12 mm	1	34472	250 x 130 x 12 mm	1

HLADIDLO PLASTOVÉ S JEMNOU HUBOU



NÁHRADNÝ POVRCH - JEMNÁ HUBA



Č.p.	špecifikácia		Č.p.	špecifikácia	
34405	280 x 140 x 18 mm	15	34480	280 x 140 x 12 mm	15
34420	250 x 130 x 18 mm	15	34481	250 x 130 x 12 mm	15
34454	220 x 130 x 18 mm	15	34482	220 x 130 x 12 mm	15
34449	220 x 70 x 18 mm	20			

Č.p.	špecifikácia		Č.p.	špecifikácia	
34262	280 x 140 x 18 mm	1	34290	280 x 140 x 12 mm	1
34227	250 x 130 x 18 mm	1	34291	250 x 130 x 12 mm	1
34465	220 x 130 x 18 mm	1	34292	220 x 130 x 12 mm	1
34474	220 x 70 x 18 mm	1			

HLADIDLO PLASTOVÉ S EXTRA JEMNOU HUBOU



Č.p.	špecifikácia	
34443	280 x 140 x 12 mm	15
34442	250 x 130 x 12 mm	15

NÁHRADNÝ POVRCH - EXTRA JEMNÁ HUBA



Č.p.	špecifikácia	
34471	280 x 140 x 12 mm	1
34470	250 x 130 x 12 mm	1

HLADIDLO PLASTOVÉ S JEMNÝM MOLITANOM



Č.p.	špecifikácia		Č.p.	špecifikácia	
34404	280 x 140 x 30 mm	10	34419	250 x 130 x 20 mm	10
34485	280 x 130 x 20 mm	10	34453	220 x 130 x 20 mm	10
34486	250 x 130 x 30 mm	10	34447	220 x 70 x 20 mm	10

NÁHRADNÝ POVRCH - JEMNÝ MOLITAN



Č.p.	špecifikácia		Č.p.	špecifikácia	
34251	280 x 140 x 30 mm	1	34224	250 x 130 x 20 mm	1
34295	280 x 130 x 20 mm	1	34464	220 x 130 x 20 mm	1
34296	250 x 130 x 30 mm	1	34477	220 x 70 x 20 mm	1

HLADIDLO PLASTOVÉ S RASTROVANÝM MOLITANOM



Č.p.	špecifikácia	
34409	280 x 140 x 30 mm	10
34425	250 x 130 x 20 mm	10

NÁHRADNÝ POVRCH - RASTROVANÝ MOLITAN



Č.p.	špecifikácia	
34253	280 x 140 x 30 mm	1
34225	250 x 130 x 20 mm	1

HLADIDLO PLASTOVÉ S HRUBÝM MOLITANOM



Č.p.	špecifikácia	
34410	280 x 140 x 30 mm	10
34426	250 x 130 x 20 mm	10

NÁHRADNÝ POVRCH - HRUBÝ MOLITAN



Č.p.	špecifikácia	
34261	280 x 140 x 30 mm	1
34226	250 x 130 x 20 mm	1

HLADIDLO PLASTOVÉ S MORSKOU HUBOU



Č.p.	špecifikácia	
34406	280 x 140 x 30 mm	10
34421	250 x 130 x 30 mm	10
34455	220 x 130 x 30 mm	10

NÁHRADNÝ POVRCH - MORSKÁ HUBA



Č.p.	špecifikácia	
34265	280 x 140 x 30 mm	1
34228	250 x 130 x 30 mm	1
34466	220 x 130 x 30 mm	1

HLADIDLO PLASTOVÉ S MORSKOU HUBOU, RASTROVANOU



Č.p.	špecifikácia	
34413	280 x 140 x 30 mm	10
34428	250 x 130 x 30 mm	10

NÁHRADNÝ POVRCH - MORSKÁ HUBA RASTROVANÁ



Č.p.	špecifikácia	
34264	280 x 140 x 30 mm	1
34233	250 x 130 x 30 mm	1

HLADIDLO PLASTOVÉ S HYDRO HUBOU HRUBOU



Č.p.	špecifikácia	
34412	280 x 140 x 30 mm	10
34424	250 x 130 x 30 mm	10
34458	220 x 130 x 30 mm	10

NÁHRADNÝ POVRCH - HYDRO HUBA HRUBÁ

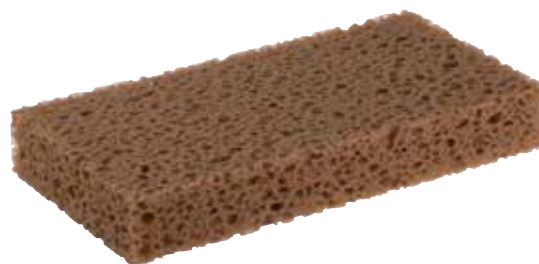

Č.p.	špecifikácia	
34238	280 x 140 x 30 mm	1
34236	250 x 130 x 30 mm	1
34469	220 x 130 x 30 mm	1

HLADIDLO PLASTOVÉ S HYDRO HUBOU, HRUBOU, RASTROVANÉ



Č.p.	špecifikácia	
34490	280 x 140 x 30 mm	10
34491	250 x 130 x 30 mm	10

NÁHRADNÝ POVRCH - HYDRO HUBA HRUBÁ, RASTROVANÁ

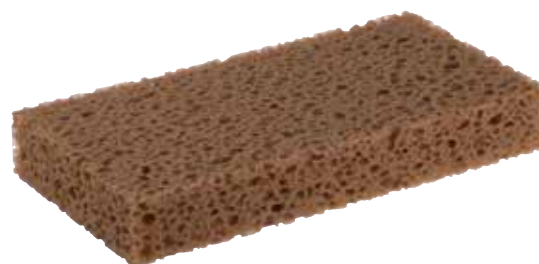

Č.p.	špecifikácia	
34298	280 x 140 x 30 mm	1
34299	250 x 130 x 30 mm	1

HLADIDLO PLASTOVÉ S HYDRO HUBOU JEMNOU

FESTA

Č.p.	špecifikácia	
34411	280 x 140 x 30 mm	10
34423	250 x 130 x 30 mm	10
34457	220 x 130 x 30 mm	10

NÁHRADNÝ POVRCH - HYDRO HUBA JEMNÁ



Č.p.	špecifikácia	
34237	280 x 140 x 30 mm	1
34235	250 x 130 x 30 mm	1
34468	220 x 130 x 30 mm	1

HLADIDLO PLASTOVÉ S GUMOVOU PENOU

FESTA

Č.p.	špecifikácia	
34402	280 x 140 x 10 mm	15
34417	250 x 130 x 10 mm	15
34452	220 x 130 x 10 mm	15

NÁHRADNÝ POVRCH - GUMOVÁ PENA



Č.p.	špecifikácia	
34231	280 x 140 x 10 mm	1
34222	250 x 130 x 10 mm	1
34462	220 x 130 x 10 mm	1

HLADIDLO PLASTOVÉ S MIKROPŘYŽOU

FESTA



Č.p.	špecifikácia	
34403	280 x 140 x 8 mm	15
34418	250 x 130 x 8 mm	15
34496	220 x 130 x 8 mm	15

NÁHRADNÝ POVRCH - MIKROPŘYŽ

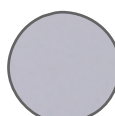

Č.p.	špecifikácia	
34232	280 x 140 x 8 mm	1
34230	250 x 130 x 8 mm	1
34463	220 x 130 x 8 mm	1

HLADIDLO PLASTOVÉ - DUREN

FESTA

Č.p.	špecifikácia	
34407	280 x 140 x 20 mm	10
34422	250 x 130 x 20 mm	10
34456	220 x 130 x 20 mm	10
34448	220 x 70 x 20 mm	10

NÁHRADNÝ POVRCH - DUREN



Č.p.	špecifikácia	
34266	280 x 140 x 20 mm	1
34267	250 x 130 x 20 mm	1
34467	220 x 130 x 20 mm	1
34478	220 x 70 x 20 mm	1

HLADIDLO PLASTOVÉ - RUVEN

FESTA®



Č.p.	špecifikácia	
34414	280 x 140 x 20 mm	10
34429	250 x 130 x 20 mm	10
34459	220 x 130 x 20 mm	10
34479	220 x 70 x 20 mm	10

NÁHRADNÝ POVRCH - RUVEN



Č.p.	špecifikácia	
34167	280 x 140 x 20 mm	1
34168	250 x 130 x 20 mm	1

HLADIDLO ŠKÁROVACIE

FESTA®



Č.p.	špecifikácia	
34033	240 x 95 mm	5

HLADIDLO PLAST BEZ POVRCHU

FESTA®



Č.p.	špecifikácia	
30003	270 x 125 mm	28
30004	235 x 115 mm	35
30005	210 x 115 mm	38
30007	210 x 60 mm	44

HLADIDLO KÚTOVÉ S HUBOU 90°

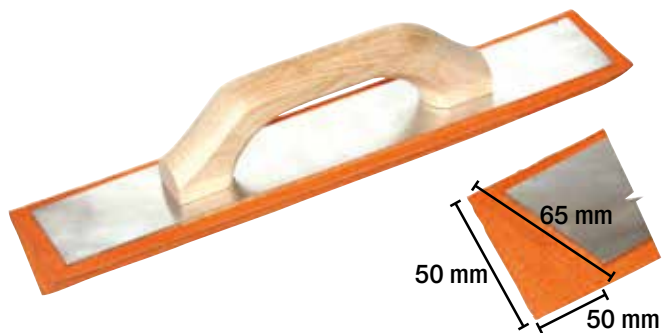

Č.p.	špecifikácia	
34500	350 mm	6

NABERAČKA MURÁRSKA S RÚČKOU, NEREZ

FESTA
INOX

Č.p.	špecifikácia	
32285	Ø 180 mm	1

NABERAČKA MURÁRSKA S RÚČKOU, POZINK

FESTA
Zn

Č.p.	špecifikácia	
32265	Ø 180 mm	10

NABERAČKA MURÁRSKA S RÚČKOU

FESTA

Č.p.	špecifikácia	
32273	Ø 160 mm	10
32285	Ø 180 mm	10
32293	Ø 215 mm	10

NABERAČKA MURÁRSKA PLASTOVÁ



Č.p.	špecifikácia	
32270	Ø 160 mm	1

NABERAČKA MURÁRSKA OCEĽ



Č.p.	špecifikácia	
32302	Ø 180 mm	1
32313	Ø 215 mm	1
32301	Ø 235 mm	1

· vhodná násada 61215

NABERAČKA MURÁRSKA OCEĽ S RÚČKOU PRE LOPATOVÚ NÁSADU

· vhodná násada 61200, 61201



Č.p.	špecifikácia	
32268	Ø 215 mm	1
32269	Ø 235 mm	1
32296	Ø 215 mm	1

NABERAČKA MURÁRSKA OCEĽ S NÁSADOU

MOQ
3

Č.p.	špecifikácia	
32295	Ø 180 mm dĺžka násady 160 cm	3
32297	Ø 215 mm dĺžka násady 160 cm	3
32298	Ø 235 mm dĺžka násady 160 cm	3

HRABLO NA BETÓN



Č.p.	špecifikácia	
60100	hrablo na betón 295 x 150 mm	24
61169	hrablo s násadou 160 cm	3
61218	násada 160 cm	5

ELEKTRICKÉ MIEŠADLO STAVEBNÝCH ZMESÍ DVOJMETĽOVÉ

FESTA®

NEW

Zn

CE



Príkon	1800 W
Napätie/frekvencia	230 V / 50 Hz
Rýchlostné stupne	2
1. stupeň (voľnobežné otáčky)	0 - 450 ot./min.
2. stupeň (voľnobežné otáčky)	0 - 790 ot./min.
Ochrana proti preťaženiu	Ano
Priemer miešacieho koša	100 mm
Dĺžka miešacej metly	570 mm
Hmotnosť	5,6 kg



Č.p.	špecifikácia	
35311	miešadlo	1
35318	náhradný uhlík	1
35319	miešadlá náhradné - pár (L+P)	1

ELEKTRICKÉ MIEŠADLO STAVEBNÝCH ZMESÍ 850 W

M14

Zn

CE



Príkon	850 W
Napätie/frekvencia	230 V / 50 Hz
Rýchlostné stupne	1
1. stupeň (voľnobežné otáčky)	0 - 500 ot./min.
2. stupeň (voľnobežné otáčky)	-
Ochrana proti preťaženiu	Ano
Závit míchací metly	M 14
Priemer miešacieho koša	120 mm
Dĺžka miešacej metly	600 mm
Hmotnosť	3,7 kg



Č.p.	špecifikácia	
35300		1
35316	náhradný uhlík	1

ELEKTRICKÉ MIEŠADLO STAVEBNÝCH ZMESÍ 1600 W

M14

Zn

CE



Príkon	1600 W
Napätie/frekvencia	230 V / 50 Hz
Rýchlostné stupne	2
1. stupeň (voľnobežné otáčky)	0 - 480 ot./min.
2. stupeň (voľnobežné otáčky)	0 - 800 ot./min.
Ochrana proti preťaženiu	Ano
Závit míchací metly	M 14
Priemer miešacieho koša	140 mm
Dĺžka miešacej metly	600 mm
Hmotnosť	4,7 kg



Č.p.	špecifikácia	
35310		1
35317	náhradný uhlík	1

MIEŠADLO S KRUHOM PRAVOTOČIVÉ

Zn

M14



Špirálová metla s tromi ramenami a krúžkom pravotočivá - pre ťažké materiály s vysokou viskozitou. Malty, betóny, cementové a vápenné omietky, spojovacie hmoty, mazaniny, epoxidové živice, živичné vrstvy- Miešací účinok odspodu nahor - metla sa ako skrutka vtahuje do materiálu.



Č.p.	špecifikácia	
35059	M14 Ø 90 x 550 mm	24
35085	M14 Ø 120 x 600 mm	12
35086	M14 Ø 140 x 600 mm	12
35087	M14 Ø 160 x 600 mm	12

MIEŠADLO S KRUHOM ĽAVOTOČIVÉ

Zn

M14



Špirálová metla s tromi ramenami a krúžkom ľavotočivá - pre riedke tekuté zmesi vo veľkom množstve. Miešaný materiál je tlačný nadol. Riedky tekutý materiál nestrieka z nádoby, usadené pigmenty farieb sa dostávajú nahor a ideálne sa premiešajú.



Č.p.	špecifikácia	
35091	M14 Ø 120 x 600 mm	12
35092	M14 Ø 140 x 600 mm	12
35093	M14 Ø 160 x 600 mm	12

MIEŠADLO S KRUHOM



Zn



Špirálová metla s dvoma ramenami - pre dôkladné rozmiešanie lepidiel na obklady, špárovacích hmôt, lepiacich mált, hotových omietok, mazaniny, stierkovacích hmôt, vyrovnávacích hmôt.

Č.p.	špecifikácia	
35038	Ø 80 x 500 mm	24
35058	Ø 100 x 500 mm	24
35023	Ø 120 x 500 mm	24

MIEŠADLO S KRUHOM

SDS+

Zn



Špirálová metla s dvoma ramenami - pre dôkladné rozmiešanie lepidiel na obklady, špárovacích hmôt, lepiacich mált, hotových omietok, mazaniny, stierkovacích hmôt, vyrovnávacích hmôt.

Č.p.	špecifikácia	
35094	Ø 80 x 500 mm	24
35095	Ø 100 x 500 mm	24
35096	Ø 120 x 500 mm	24

MIEŠADLO S KRUHOM, PREDĹŽENÁ ŠPIRÁLA



Zn



Špirálová metla s dvoma ramenami - pre dôkladné rozmiešanie lepidiel na obklady, špárovacích hmôt, lepiacich mált, hotových omietok, mazaniny, stierkovacích hmôt, vyrovnávacích hmôt.

Č.p.	špecifikácia	
35013	Ø 80 x 500 mm	24
35006	Ø 100 x 500 mm	24
35007	Ø 120 x 500 mm	24

MIEŠADLO S KRUHOM, PREDĹŽENÁ ŠPIRÁLA

SDS+

Zn



Špirálová metla s dvoma ramenami - pre dôkladné rozmiešanie lepidiel na obklady, špárovacích hmôt, lepiacich mált, hotových omietok, mazaniny, stierkovacích hmôt, vyrovnávacích hmôt.

Č.p.	špecifikácia	
35012	Ø 100 x 500 mm	24

MIEŠADLO ŠPIRÁLA DRÔT



Zn



Špirálová metla s dvoma ramenami - pre dôkladné rozmiešanie lepidiel na obklady, špárovacích hmôt, lepiacich mált, hotových omietok, mazaniny, stierkovacích hmôt, vyrovnávacích hmôt.

Č.p.	špecifikácia	
35069	Ø 60 x 500 mm	50
35078	Ø 80 x 500 mm	24
35081	Ø 100 x 500 mm	24

MIEŠADLO ŠPIRÁLA DRÔT

SDS+

Zn



Špirálová metla s dvoma ramenami - pre dôkladné rozmiešanie lepidiel na obklady, špárovacích hmôt, lepiacich mált, hotových omietok, mazaniny, stierkovacích hmôt, vyrovnávacích hmôt.

Č.p.	špecifikácia	
35070	Ø 60 x 500 mm	50
35079	Ø 80 x 500 mm	24
35082	Ø 100 x 500 mm	24

MIEŠADLO BEZ KRUHU



Zn



Špirálová metla s dvoma ramenami - pre dôkladné rozmiešanie lepidiel na obklady, špárovacích hmôt, lepiacich mált, hotových omietok, mazaniny, stierkovacích hmôt, vyrovnávacích hmôt.

Č.p.	špecifikácia	
35048	Ø 70 x 500 mm	24
35068	Ø 90 x 500 mm	24

MIEŠADLO BEZ KRUHU



Zn



Špirálová metla - pre vysoko viskózne a lepkavé materiály, ako sú stavebné lepidlá a tmely, omietky, podlahové stierky a pod. Materiál prúdi od dna k hladine.

Č.p.	špecifikácia	
35021	Ø 100 x 500 mm	24

MIEŠADLO KALICH



Zn



Klietková metla - pre materiály, kde je zavzdušnenie zmesi nežiaduce. Pre riedke vyrovnávacie hmoty, stierkové hmoty, tesniace látky, lepidlá.

Č.p.	špecifikácia	
35015	Ø 100 x 500 mm	20

MIEŠADLO VRTULE



Zn



Vrtulová metla - pre tekuté materiály, farby, laky, nástenné a disperzné klihy na lepenie tapiet, lepidlá na dlaždice.

Č.p.	špecifikácia	
35011	Ø 80 x 500 mm	50

MIEŠADLO S KRUHOM



Zn



Oblúčková metla s kruhom - pre dôkladné rozmiešanie nástenných farieb, disperzných farieb, glejov, lakov.

Č.p.	špecifikácia	
35125	Ø 60 x 400 mm	40
35126	Ø 80 x 400 mm	40
35127	Ø 100 x 600 mm	20

MIEŠADLO S KRUHOM LAKOVANÉ



Oblúčková metla s kruhom - pre dôkladné rozmiešanie nástenných farieb, disperzných farieb, glejov, lakov.

Č.p.	špecifikácia	
35103	Ø 60 x 400 mm	40
35113	Ø 80 x 400 mm	40
35123	Ø 100 x 600 mm	20

KÁBEL PREDLŽOVACÍ S NAVIJAKOM



KÁBEL PREDLŽOVACÍ



- Predlžovací prívod s navijakom 25 m - IP20
- H05VV - F 3G 1,5mm², - Vybavený tepelnou poistkou
- Výkon v navinutom stave: 1000 W max.
- Výkon v rozvinutom stave: 3000 W max.
- 4 uzemnené zásuvky s detskou poistkou



Č.p.	špecifikácia	
37760	4 zásuvky dĺžka 25 m, IP 20, 1,5 mm ²	2
37761	4 zásuvky dĺžka 50 m, IP 20, 1,5 mm ²	2

Č.p.	špecifikácia	
37730	max. 3680 W dĺžka 10 m, 1,5 mm ²	8
37731	max. 3680 W dĺžka 20 m, 1,5 mm ²	4

OHRIEVAČ ELEKTRICKÝ



napätie	230V ~50Hz
výkon	3300W
prúdové zaťaženie	14,5A
nastavenie výkonu	30/1650/3300W
teplotný rozsah	5-40°C
krytie	IP24
rozmery	27 x 25,5 x 40cm
hmotnosť	4,8 kg

- Rýchle a efektívne vykurovanie pivníc, dielní, obchodov, párty stanov, skleníkov atď.
- Nespotrebáva kyslík
- Bezpečná prevádzka, plynulá regulácia výkonu, priestorový termostat, ventilátor
- Vyhrevné teleso z nehrdzavejúcej ocele
- Možnosť letného využitia pre ventiláciu bez ohrevu · Nízka hladina hluku
- Kvalitné spracovanie, materiály, robustná oceľová konštrukcia, ľahká a bezpečná manipulácia, dlhá životnosť

Č.p. 35833
špecifikácia 3,3 kW



1

OHRIEVAČ PLYNOVÝ



plyn	G30-I3B/P
tlak plynu	0,7bar
menovité napätie	230V 50Hz
výkon motora	25W
maximálna spotreba plynu	1,11 Kg/h
maximálny tepelný výkon	15KW
maximálny objem horúceho vzduchu	300m ³ /h

- Rýchle a efektívne vykurovanie pri stavebných prácach, v dielnach, atď.
- Spotrebáva kyslík!
- Priamy ohrev vzduchu s nútenou cirkuláciou - rýchly nástup tepla
- Bezpečná prevádzka, plynulá regulácia výkonu
- Termostat a bezpečnostný ventil proti prehriatiu a úniku plynu
- Vratane príslušenstva - regulátor a prívodná plynová hadica
- Kvalitné spracovanie, materiály, robustná oceľová konštrukcia, jednoduchá a bezpečná manipulácia, dlhá životnosť

Č.p. 35845
špecifikácia 15 kW



1

OHRIEVAČ PLYNOVÝ



plyn	g30-i3b/p
tlak plynu	1,5bar
menovité napätie	230v 50hz
výkon motora	70w
maximálna spotreba plynu	2,2kg/h
maximálny tepelný výkon	30kw
maximálny objem horúceho vzduchu	750m ³ /h

- Rýchle a efektívne vykurovanie pri stavebných prácach, v dielnach, atď.
- Spotrebáva kyslík!
- Priamy ohrev vzduchu s nútenou cirkuláciou - rýchly nástup tepla
- Bezpečná prevádzka, plynulá regulácia výkonu
- Termostat a bezpečnostný ventil proti prehriatiu a úniku plynu
- Vratane príslušenstva - regulátor a prívodná plynová hadica
- Kvalitné spracovanie, materiály, robustná oceľová konštrukcia, jednoduchá a bezpečná manipulácia, dlhá životnosť

Č.p. 35850
špecifikácia 30 kW



1



Stavebné miešacky pre najnáročnejšie profesionálne použitie

Zubový veniec z liatiny s patentovaným uchytením

Nastaviteľná vôľa zubov

Vysoko kvalitná povrchová úprava

Dvojité uloženie ložísk na dne bubna

Patentovaná ochranná izolácia, kvalitatívne istenie podľa DIN EN ISO 9001

Špeciálne vyvinutý tvar bubna

Ochrana proti striekajúcej vode IP 45

Dodávané v prevedení na 230V aj 400V

PROFESIONÁLNE STAVEBNÉ MIEŠAČKY

Lescha

MIEŠAČKA STAVEBNÁ



Lescha



Č.p.	špecifikácia
35500	Star 150 - 125 230 V nožná brzda



1

MIEŠAČKA STAVEBNÁ



Lescha



Č.p.	špecifikácia
35502	EUROMIX 125 230 V
35503	EUROMIX 125 400 V



1

1

MIEŠAČKA STAVEBNÁ



Lescha



Č.p.	špecifikácia
35501	BX 135 - 125 230 V



1

MIEŠAČKA STAVEBNÁ



Lescha



Č.p.	špecifikácia
35504	ABM 135 230 V nožná brzda



1

MIEŠAČKA STAVEBNÁ



Lescha



Č.p.	špecifikácia
35505	SM 145 S - 140 230 V
35506	SM 145 S - 140 400 V
35507	SM 145 S - 140 230 V nožná brzda
35508	SM 145 S - 140 400 V nožná brzda



1

1

1

1

MIEŠAČKA STAVEBNÁ



Lescha



Č.p.	špecifikácia
35510	SM 165 S - 160 230 V nožná brzda
35511	SM 165 S - 160 400 V nožná brzda
35512	SM 165 S - 160 G benzínová



1

1



1

MIEŠAČKA STAVEBNÁ



Lescha



Č.p.	špecifikácia		
35514	SM 185 S - 180 230 V nožná brzda	1	
35515	SM 185 S - 180 400 V nožná brzda	1	

MIEŠAČKA STAVEBNÁ



Lescha



Č.p.	špecifikácia		
35516	S 180 HR - 180 230 V nožná brzda	1	
35517	S 180 HR - 180 400 V nožná brzda	1	

MIEŠAČKA STAVEBNÁ



Lescha



Č.p.	špecifikácia		
35524	LB 354 230 V 1,5 kW		1
35525	LB 354 400 V 1,5 kW		1
35527	LB 354 Honda G200		1
35532	LB 404 230 V, 1,5 kW		1
35533	LB 404 400 V, 1,5 kW		1
35539	LB 484 Robin EH17B		1
35540	LB 484 Honda GX160LX		1
35542	AT 480 400 V, 1,2 kW		1

MIEŠAČKA STAVEBNÁ



Lescha



Č.p.	špecifikácia		
35552	LHB 1000 400 V		1
35553	LHB 1000 HATZ Diesel		1
35555	LHB 1200 400 V		1

MIEŠAČKA STAVEBNÁ



Lescha



Č.p.	špecifikácia		
35518	S 230 HR - 230 230 V nožná brzda		1
35519	S 230 HR - 230 400 V nožná brzda		1



MIEŠAČKA STAVEBNÁ



130 L

špecifikácia	
objem bubna	130 l
otáčky bubna	26±Min ⁻¹
príkon	700 W
napätie	230 V / 50 Hz
stupeň krytia	IP44
materiál venca	liatinový
rozмеры	dĺžka 1170 mm
	šírka 650 mm
	výška 1280 mm
váha	53 kg

165 L

špecifikácia	
objem bubna	165 l
otáčky bubna	23±Min ⁻¹
príkon	900 W
napätie	230 V / 50 Hz
stupeň krytia	IP44
materiál venca	liatinový
rozмеры	dĺžka 1295 mm
	šírka 735 mm
	výška 1440 mm
váha	70 kg

Č.p.	špecifikácia				
37500	MIX 130Zk	230 V	rozložená		1
37501	MIX 130Z	230 V	zložená		1
37505	MK 165Bk	230 V	rozložená		1
37506	MK 165B	230 V	zložená		1

MIEŠAČKA STAVEBNÁ



· špeciálne vyrobené lopatky, hrúbka 4 mm



· kvalitné pätňé ložisko s krytom



· vypínač s bezpečnostnou krytkou



· plastový kryt pohonu, liatinový veniec

125 L

špecifikácia	
objem bubna	125 l
otáčky bubna	26±Min ⁻¹
príkon	550 W
napätie	230 V / 50 Hz
stupeň krytia	IP44
materiál venca	liatinový
rozмеры	dĺžka 1102 mm šírka 690 mm výška 1310 mm
váha	52,5 kg

Č.p.	špecifikácia		
37509	126 l 230 V	zložená	1
37510	126 l 230 V	rozložená	1

142 L

špecifikácia	
objem bubna	142 l
otáčky bubna	26±Min ⁻¹
príkon	650 W
napätie	230 V / 50 Hz
stupeň krytia	IP44
materiál venca	liatinový
rozмеры	dĺžka 1164 mm šírka 690 mm výška 1293 mm
váha	54 kg

Č.p.	špecifikácia		
37511	142 l 230 V	rozložená	1
37512	142 l 230 V	zložená	1

162 L

špecifikácia	
objem bubna	162 l
otáčky bubna	26±Min ⁻¹
príkon	650 W
napätie	230 V / 50 Hz
stupeň krytia	IP44
materiál venca	liatinový
rozмеры	dĺžka 1180 mm šírka 710 mm výška 1310 mm
váha	56 kg

Č.p.	špecifikácia		
37515	162 L 230 V	rozložená	1
37516	162 L 230 V	zložená	1

180 L

špecifikácia	
objem bubna	180 l
otáčky bubna	26±Min ⁻¹
príkon	850 W
napätie	230 V / 50 Hz
stupeň krytia	IP44
materiál venca	liatinový
rozмеры	dĺžka 1164 mm šírka 690 mm výška 1368 mm
váha	58 kg

Č.p.	špecifikácia		
37517	180 l 230 V	rozložená	1
37518	180 l 230 V	zložená	1

ZHADZOVANIE STAVEBNEJ SUTE

Lescha
MADE IN
EU



Č.p.	špecifikácia	
35603	zhoz základný priemer 50 cm, dĺžka 110 cm PE (HDPE)	1
35604	násypka zhodu stavebnej sutiny PE (HDPE)	1
35605	nosný rám pre násypku zhodu stavebnej sutiny	1



KOLIESKO STAVEBNÉ



Č.p.	špecifikácia	
37530	60 l, Ø 38 cm samonosné koliesko	1
37532	60 l, Ø 40 cm nafukovacie	1

KOLIESKO STAVEBNÉ POZINK



Zn



Č.p.	špecifikácia	
37527	80 l, Ø 40 cm nafukovacie	1
37533	80 l, Ø 38 cm samonosné koliesko	1

KORBA ČIERNA



Č.p.	špecifikácia	
37539	60 l	1

KORBA POZINK



Zn



Č.p.	špecifikácia	
37541	80 l	1

NÁHRADNÉ KOLESÁ



Č.p.	špecifikácia		
48729	typ AA 400	nafukovacie	1
48730	typ AA 380	samonosné	1
48731	typ AA 380	samonosné	1

JAPONKA STAVEBNÁ TROJKOLESOVÁ



Č.p.	špecifikácia		
37564	60 l		1

DRŽIAK DLAŽBY NASTAVITEĽNÝ



Č.p.	špecifikácia	
36310		5

NOSIČ OBRUBNÍKOV



špecifikácia 60115
 rozmer čelústí: 80-370 mm
 max. zaťaženie: 50 kg



Č.p.	špecifikácia	
60115	PRO 040	1

NOSIČ OBRUBNÍKOV



špecifikácia 60116
 rozmer čelústí: 750-1000 mm
 max. zaťaženie: 120 kg



Č.p.	špecifikácia	
60116	PRO 041	1

NOSIČ OBRUBNÍKOV



špecifikácia 60117 60118
 rozmer čelústí: 500-1000 mm 0-500 mm
 max. zaťaženie: 150 kg 150 kg



Č.p.	špecifikácia	
60117	PRO 042	1
60118	PRO 043	1

KLADIVO PRE VYROVNANIE OBRUBNÍKOV



špecifikácia	60121	60123
výška	200 mm	200 mm
šírka	70 mm	70 mm
dĺžka	870 mm	450 mm
hmotnosť	2,5 kg	2,2 kg

Č.p.	špecifikácia	
60121	870 mm	1
60123	450 mm	1

PODLOŽKA VYROVNÁVACIA POD DLAŽBU



Č.p.	špecifikácia	
37166	D10 základná	25

RUDLA



Č.p.	špecifikácia	nosnosť	
48719	kolo 260 mm bantam	250 kg	1

KOZA NA REZANIE DREVA

NEW

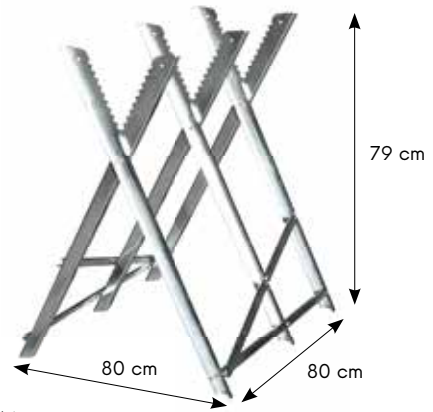

Č.p.	špecifikácia	
37570	max. 150 kg	1

KOZA SKLADACIA

2x

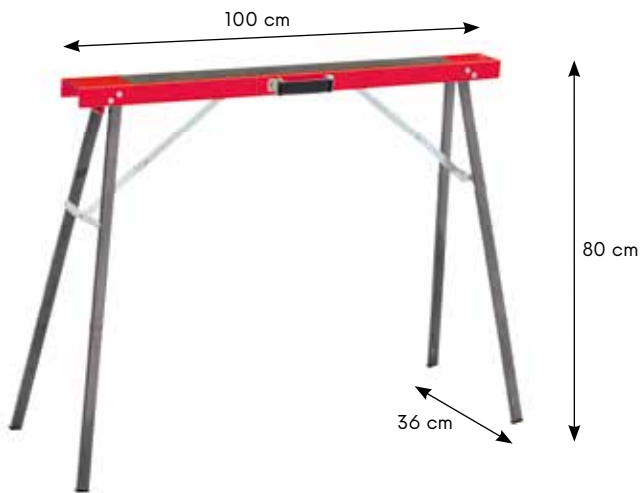

· max. nosnosť 125 kg

Č.p.	špecifikácia	
37549	pár	1

KOZA PLASTOVÁ, SKLADACIA

2x



· max. nosnosť 150 kg (300 kg v páre)

Č.p.	špecifikácia	
37560	pár	1

PODPERA STAVEBNÁ

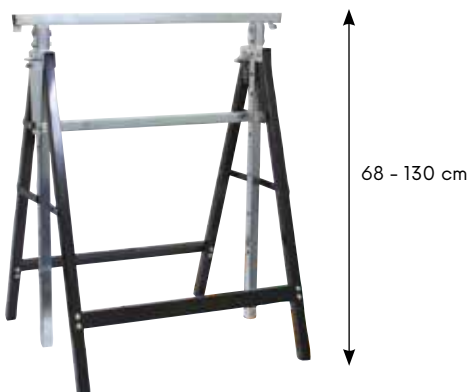

Č.p.	špecifikácia	
36300	68 - 130 cm, max. 150 kg	1

KOZA LEŠENÁRSKA



Č.p.	špecifikácia	
37545	140 cm, výška 98 - 165 cm	1
37546	120 cm, výška 98 - 165 cm	1

PROFESIONÁLNE REZAČKY OBKLADOV

- Rezačky dlažby pre najnáročnejšie profesionálne použitie
- Pojazd je riešený 9 zapúzdrenými guľčkovými ložiskami SKF
- 4 sú nastaviteľné a vymedzujú vôľu pojazdu
- Odpružené stoly
- Možno kompletizovať aj pre prácu ľavou rukou
- Zabezpečené všetky náhradné diely a servis
- Rezná kolieska z chróm volfrámovej ocele



REZAČKA DLAŽBY SUPER PRO "EVO"

NEW



SUPER PRO



- 36195 náhr. rezné koliesko - Ø 22 mm

Č.p.	špecifikácia
36191	1250 mm



REZAČKA DLAŽBY SUPER PRO



- 36195 náhr. rezné koliesko - Ø 22 mm



SUPER PRO



Č.p.	špecifikácia
36145	SUPER PRO 450 mm
36160	SUPER PRO 600 mm
36175	SUPER PRO 750 mm
36190	SUPER PRO 900 mm



REZAČKA DLAŽBY BASIC PLUS + KUFOR



PREDAJNÝ STOJAN



· ilustračné foto

Č.p.	špecifikácia	
36200	predajný stojan	1
36199	predajný stojan osadený 36160, 36175, 36190	1

· 36261 náhr. rezné koliesko - Ø 15 mm

Č.p.	špecifikácia	
36240	400 mm	1

REZAČKA DLAŽBY „X“



FESTA®

· 36138 náhr. rezné koliesko - Ø 22 mm

Č.p.	špecifikácia	
36085	600 mm	1
36087	900 mm	1
36086	1300 mm	1



REZAČKA DLAŽBY



FESTA®

· 36195 náhr. rezné koliesko - Ø 22 mm

Č.p.	špecifikácia	
36080	600 mm	1
36081	750 mm	1
36082	900 mm	1



Č.p.	špecifikácia	
36076	750 mm zložená	1
36077	900 mm zložená	1

REZAČKA DLAŽBY S VYKRUŽOVÁKOM

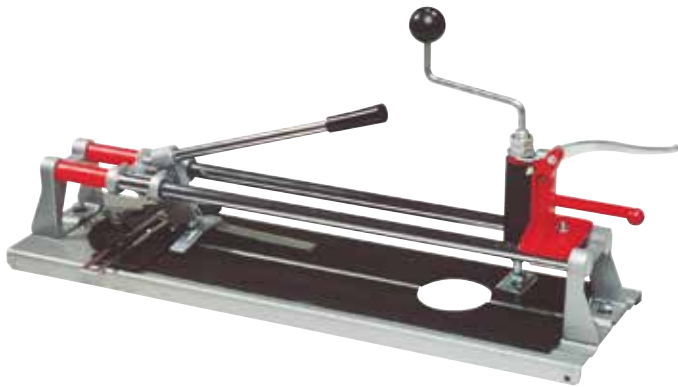

· 36128 náhr. rezné koliesko - Ø 16 mm

Č.p.	špecifikácia
36014	480 mm



4

REZAČKA DLAŽBY



· 36126 náhr. rezné koliesko - Ø 15 mm

Č.p.	špecifikácia
36024	300 mm
36034	400 mm
36035	600 mm



10
10
4

REZAČKA DLAŽBY



· 36136 náhr. rezné koliesko - Ø 22 mm

Č.p.	špecifikácia
36036	480 mm



1

REZAČKA DLAŽBY RUČNÁ



· 36136 náhr. rezné koliesko - Ø 22,2 mm

Č.p.	špecifikácia
36046	22 mm



1

NÁHRADNÉ KOLIESKO DO REZAČIEK DLAŽBY

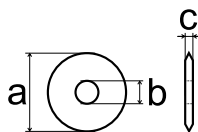

Č.p.	špecifikácia
36126	a= Ø 15 mm, b= Ø 6 mm, c= 1,5 mm
36128	a= Ø 16 mm, b= Ø 6 mm, c= 3 mm
36130	a= Ø 20 mm, b= Ø 6 mm, c= 5 mm
36136	a= Ø 22 mm, b= Ø 6 mm, c= 2 mm



1

PÍLKA PRIAMOČIARA NA OBKLADY A KERAMIKU



Č.p.	špecifikácia
24055	Karbid - BOSCH, MAKITA



1

KLIESTE NA OBKLADY

FESTA

KLIESTE NA OBKLADY

NEW

Č.p.	špecifikácia
36057	200 mm

6



Č.p.	špecifikácia
36056	

10

KLIESTE ŠTIEPACIE NA KERAMIKU



Č.p.	špecifikácia
36059	

1

KLIESTE (PAPAGÁJ)



Č.p.	špecifikácia
36058	200 mm

6

VYMÝVACIE HUBY 160 X 110 X 60 MM



37028



37029

Č.p.	špecifikácia	
37028	hydro huba	1
37029	morská huba	1

VYMÝVACIE HUBY 200 X 100 X 100 MM



37025



37026

Č.p.	špecifikácia	
37025	jemný molitan	1
37026	morská huba	1

VANIČKA VYMÝVACIA



Č.p.	špecifikácia	
37117	sada	1
90070	nádoba 25 l	1

VANIČKA VYMÝVACIA - PRÍSLUŠENSTVO



Č.p.	špecifikácia	
90072	mriežka	1
90071	valčeky kovové	1

ČISTIČ ŠPÁR



4 mm



Č.p.	špecifikácia
37012	

1

ČISTIČ ŠPÁR



37006

37007



Č.p.	špecifikácia	
37006	30 mm	20
37007	50 mm	20
37008	náhradné ostrie 30 mm	50
37009	náhradné ostrie 50 mm	50

SADA NA APLIKÁCIU A ODSTRÁNENIE SILIKÓNU

3x



Č.p.	špecifikácia
16042	

12

SADA STIEROK

4x



Č.p.	špecifikácia
37053	

48

APLIKÁTOR SILIKÓNU

FESTA



Č.p.	špecifikácia
16056	145 mm

50

STIERKA



Č.p.	špecifikácia
37054	

1

STIERKA



na škárovanie okien



Č.p.	špecifikácia
37055	na škárovanie okien

1

STIERKA DREVENÁ S GUMOU



Č.p.	špecifikácia
37011	180 mm
37021	280 mm

12

12

MAGNETY POD OBKLADY



4x

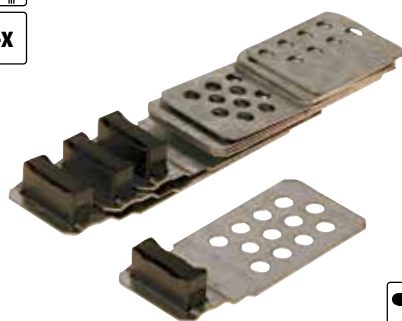

Č.p. špecifikácia

38920



1

MAGNETY NASTAVITEĽNÉ POD OBKLADY



4x



Č.p. špecifikácia

38923



24

ROŽKY STAVEBNÉ - SADA



Č.p. špecifikácia

38919



50

MONTÁŽNA SADA NA PLÁVAJÚCE PODLAHY

24x



Č.p. špecifikácia

52130



1

MONTÁŽNE KLINKY - PLAST

50x



Č.p. špecifikácia

37210

95 x 45 x 15 - 0 mm

ks / pcs

50



1

37211

70 x 30 x 8 - 0 mm

50

1

VANKÚŠIK MONTÁŽNY, ROZPÍNACÍ

· rozmery 15x17 cm
· max. výška 5 cm

Č.p. špecifikácia

37220



1

VYMEDZOVACIE PODLOŽKY

30x

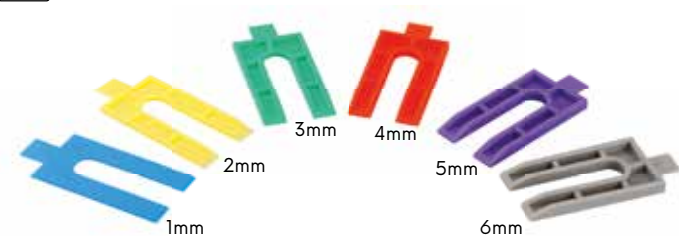

Č.p. špecifikácia

37212

1 - 6 mm, 5 ks od každej veľkosti



1

MONTÁŽNE KLINKY - DREVO



FESTA



Č.p. špecifikácia

37204

55 x 20 x 0 - 6 mm

ks

20

37203

65 x 18 x 0 - 12 mm

20

37202

80 x 25 x 3 - 10 mm

20

37201

100 x 25 x 1 - 16 mm

14

37200

150 x 25 x 1 - 25 mm

8

37205

55 x 8 x 0 - 10 mm

250



1

1

1

1

1

1

PIŠTOĽ ŠKÁROVACIA



Č.p. špecifikácia

38026

5x špička



1

VRECE ŠKÁROVACIA

MADE IN EU



Č.p. špecifikácia

38042

3x špička



1

KRÍŽIKY DIŠTANČNÉ

100x



· opakovane použiteľné

Č.p.	špecifikácia	ks	
37195	1,0 mm	100	12
37196	1,5 mm	100	12
37197	2 mm	100	12
37198	3 mm	100	12

KRÍŽIKY OBKLADAČSKÉ

FESTA



Č.p.	špecifikácia	ks		Č.p.	špecifikácia	ks	
37148	1,0 mm	200	100	37152	3 mm	150	100
37149	1,5 mm	200	100	37153	4 mm	100	100
37150	2 mm	200	100	37154	5 mm	75	100
37151	2,5 mm	200	100	37158	10 mm	30	100

KLINKY OBKLADAČSKÉ

FESTA



Č.p.	špecifikácia	ks	
37155	0 - 8 mm	30	100
37156	0 - 4 mm	100	100
37157	2,5 - 8 mm	30	100

MONTÁŽNE KLINKY - DREVO

FESTA

250x



Č.p.	špecifikácia	ks	
37205	55 x 8 x 0 - 10 mm	250	1

DIŠTANČNÝ KLIP SO ZÁVITOM

50x



Č.p.	špecifikácia	
37131	1 mm	40
37132	2 mm	40

KLOBÚČIK NIVELAČNÝ SO ZÁVITOM

50x



· opakovane použiteľné

Č.p.	špecifikácia	
37130		15



DISTANČNÍ SPONY

50x





· nivelačné klinky 37175, 37176

Č.p.	špecifikácia	ks	
37170	1 mm	50	60
37171	2 mm	50	60
37172	3 mm	50	60

DIŠTANČNÉ SPONY

100x



Č.p.	špecifikácia	ks		Č.p.	špecifikácia	ks	
37185	1 mm	100	1	37187	3 mm	100	1
37190	1,5 mm	100	1	37188	4 mm	100	1
37186	2 mm	100	1	37189	5 mm	100	1

DIŠTANČNÉ SPONY

600x



Č.p.	špecifikácia	ks	krabice	
37125	1 mm	600	38 x 28 x 19 cm	1
37126	1,5 mm	600	38 x 28 x 19 cm	1
37127	2 mm	600	38 x 28 x 19 cm	1

NIVELAČNÁ SADA



Č.p.	špecifikácia	
37173	spony 1 mm, 400 ks + klinky 200 ks	1
37174	spony 1,5 mm, 400 ks + klinky 200 ks	1

NIVELAČNÉ KLINIKY



Č.p.	špecifikácia	ks	
37175		50	40
37176		400	3



KLIŠTE NIVELAČNÉ



Č.p.	špecifikácia	
37177		1

KLIŠTE NIVELAČNÉ



Č.p.	špecifikácia	
37178		1

PÚDER 180 G

FESTA



Č.p.	špecifikácia	
37096	modrý	10
37094	svetlo modrý	10
37097	červený	10
37095	svetlo červený	10
37098	čierny	10



SADA NAVÍJAČ 30 M + PÚDER 150 G

FESTA

SADA NAVÍJAČ 30 M + PÚDER 150 G

FESTA

- 3x rýchlejší mechanizmus navíjania
- Funkcie olovnice

- 5x rýchlejší mechanizmus navíjania



Č.p.	špecifikácia	
37070		6

Č.p.	špecifikácia	
37065		6

SADA NAVÍJAČ ABS 30 M + PÚDER 180 G

NAVÍJAČ ABS 30 M



Č.p.	špecifikácia	
37069		10

Č.p.	špecifikácia	
37067		25

NAVÍJAČ PLASTOVÝ 30 M

NAVÍJAČ KOVOVÝ 30 M

ALU



Č.p.	špecifikácia	
37066		25

Č.p.	špecifikácia	
37068		25

POVRÁZOK ČERVENÝ

FESTA

POVRÁZOK ŽLTÝ

FESTA



Č.p.	špecifikácia	
38895	50 m	24
38896	100 m	24



Č.p.	špecifikácia	
38899	50 m	24
38900	100 m	24

POVRÁZOK MURÁRSKY POLYETYLÉN 50 M

FESTA

POVRÁZOK MURÁRSKY POLYETYLÉN 50 M

FESTA



Č.p.	špecifikácia	
38907	červený 1,0 mm	100
38908	červený 1,7 mm	100
38909	červený 2,0 mm	100



Č.p.	špecifikácia	
38904	žltý 1,0 mm	100
38905	žltý 1,7 mm	100
38906	žltý 2,0 mm	100

POVRÁZOK MURÁRSKY POLYETYLÉN 50 M

FESTA

POVRÁZOK MURÁRSKY POLYETYLÉN 50 M

FESTA



Č.p.	špecifikácia	
38910	oranžový 1,0 mm	100
38911	oranžový 1,7 mm	100
38912	oranžový 2,0 mm	100



Č.p.	špecifikácia	
38901	biely 1,0 mm	100
38902	biely 1,7 mm	100
38903	biely 2,0 mm	100

ŠNÚRA VOSKOVANÁ



OLOVNICA S POVRÁZKOM 15 M

FESTA

OLOVNICA

FESTA



Č.p.	dĺžka	Ø	
50920	50 m	1 mm	80



Č.p.	špecifikácia	
38916	150 g	10
38917	300 g	10
38918	500 g	10



Č.p.	špecifikácia	
38913	150 g	5
38914	300 g	5
38915	500 g	5

REZAČKA POLYSTYRÉNU STRUNOVÁ



- Napätie / frekvencia: 230 V / 50 Hz
- Príkion: 160 W
- Dĺžka rezu: 137 cm
- Výška rezu: 30 cm
- Krytie: IP44
- Uhol rezu: 0° - 90°

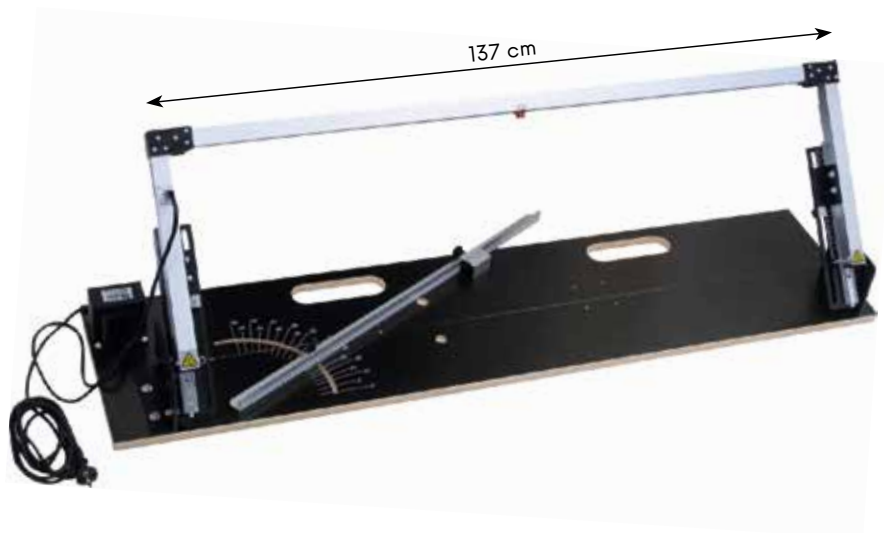

FESTA

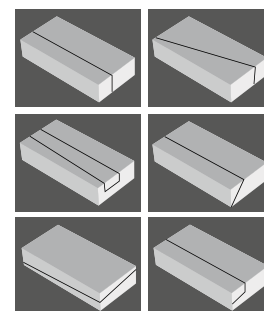

- vybavenie: Ni-Cr rezací drôt, čistiaca mosadzná kefa, inbus



Č.p.	špecifikácia	
35345	Rezačka polystyrénu 1500 x 450 mm	1
35346	Náhradná rezná struna Ni-Cr	1
35347	náhradný zdroj	1

REZAČKA POLYSTYRÉNU STRUNOVÁ



- Napätie / frekvencia: 230 V / 50 Hz
- Príkion: 160 W
- Dĺžka rezu: 120 cm
- Výška rezu: 30 cm
- Krytie: IP44
- Uhol rezu: 0° - 90°



FESTA

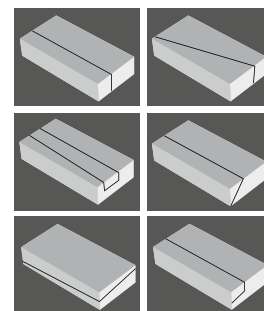

- vybavenie: Ni-Cr rezací drôt, čistiaca mosadzná kefa, inbus



Č.p.	špecifikácia	
35330	Rezačka polystyrénu 1350 x 450 mm	1
35331	Náhradná rezná struna Ni-Cr	1
35347	náhradný zdroj	1

REZAČKA POLYSTYRÉNU AKUMULÁTOROVÁ



- batéria
- výkon
- teplota
- dĺžka čepele

36 V, 1,5 Ah Li-ion
180 W
max 350 C°
20 cm

FESTA®

Li-ion
technology

- Vybavenie: 2 ks batérie, nabíjačka, čepeľ, čistiaca mosadzná kefa, inbus

Č.p. špecifikácia

35323



1

REZAČKA POLYSTYRÉNU ELEKTRICKÁ



- napätie / frekvencia
- príkon
- teplota
- dĺžka čepele
- dĺžka privodného kábla

230 V/50 Hz
250 W
50-600 C°
25 cm
3 m

FESTA®

VODIACA LIŠŤA PRE REZAČKU POLYSTYRÉNU



- pre 35323, 35326



- Vybavenie: čistiaca mosadzná kefa, inbus, nôž 25 cm, kufor

Č.p. špecifikácia



35326 Elektrická rezačka polystyrénu 1

35328 Náhr. nôž do rezačky polystyrénu 14 cm 1

35329 Náhr. nôž do rezačky polystyrénu 25 cm 1

Č.p. špecifikácia



35327 vodiaca lišta 1

35335 Náhradný nôž - 30 cm 1

REZAČKA POLYSTYRÉNU ELEKTRICKÁ



- regulácia teploty

Č.p. špecifikácia

35325 220 W



1

PODLOŽKA ZATEPLOVACIA



MOQ

Č.p.	špecifikácia	
39206	Ø 40 mm	200
39207	Ø 60 mm	100

PODLOŽKA RABICOVÁ

1000x



Č.p.	špecifikácia	
42420	Ø 30 mm	1

HMOŽDINKA FASÁDNÍ

100x



MOQ

Č.p.	špecifikácia		Č.p.	špecifikácia	
39210	Ø 10 x 100 mm	1	39218	Ø 10 x 180 mm	1
39212	Ø 10 x 120 mm	1	39217	Ø 10 x 200 mm	1
39214	Ø 10 x 140 mm	1	39219	Ø 10 x 220 mm	1
39216	Ø 10 x 160 mm	1			

FRÉZKA DO POLYSTYRÉNU



MOQ

Č.p.	špecifikácia	
24727	Ø 65 mm	1
24729	Ø 68 mm	1
24728	Ø 70 mm	1

ROH PLASTOVÝ



MOQ

Č.p.	špecifikácia	
39234	2 m	25
39238	3 m	25

ROH HLINÍKOVÝ

ALU

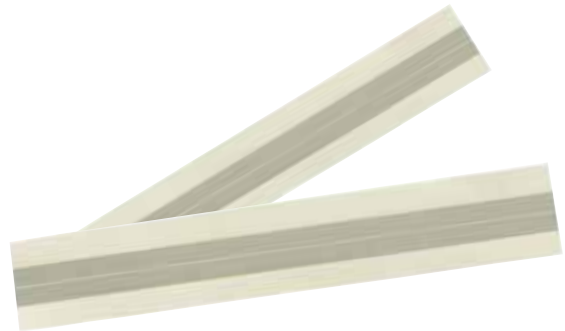

MOQ

Č.p.	špecifikácia	
39245	AL 30 m x 5 cm	1

PERLINKA

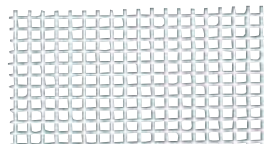

MOQ

Č.p.	špecifikácia	
42110	145 g/m ² 4 x 5 mm 1 m x 50 m	1
42112	145 g/m ² 4 x 5 mm 1 m x 10 m	1
42113	145 g/m ² 4 x 5 mm 1 m x 20 m	1

PLETIVO RABICOVÉ

Zn



MOQ

Č.p. / No.	špecifikácia	
42312	1 m 50 bm 16 x 16 mm	1

VALČEK NIVELAČNÝ



Č.p.	priemer / diameter	výška hrotov / spike height	dĺžka	
38950	Ø 69 mm	12 mm	25 cm	10
38951	Ø 69 mm	12 mm	40 cm	8
38952	Ø 122 mm	34 mm	25 mm	10
38953	Ø 122 mm	34 mm	40 cm	8
38954	Ø 122 mm	34 mm	60 mm	4

PODOŠVY S HROTI, PÁR



Č.p.	špecifikácia	
38970	hroty 25 mm	1
38971	hroty 30 mm	1

SADA PRE SADROKARTONÁROV



Č.p.	špecifikácia	
34300	sada 9 ks	10
34303	vanička	60

ZDVIHÁK SADROKARTÓNOVÝCH DOSIEK

- zdvih 153 - 344 cm
- maximálne zaťaženie 54 kg



Č.p.	špecifikácia	
26775		1

NOSIČ DOSIEK



2x



Č.p.	špecifikácia	
36312		12

NOSIČ DOSIEK



Č.p.	špecifikácia	
36308	36 x 16,5 x 7,5 cm	10

OMIETAČKA

Zn



Č.p.

37114



1

OMIETAČKA

Zn



Č.p.

37115

špecifikácia



1

SITO PREHADZOVACIE

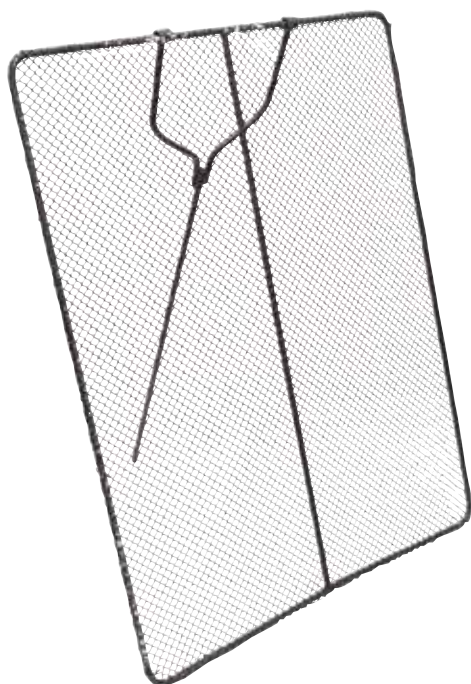

Č.p.	šírka	výška	oko sita	
37236	0,8 m	1 m	10 mm	1
37237	0,8 m	1 m	12 mm	1
37238	0,8 m	1 m	16 mm	1
37239	0,8 m	1 m	20 mm	1

SITO NA ŠTUK



Č.p.	šírka	výška	oko sita	
37216	50 mm	50 mm	2 mm	1
37217	50 mm	50 mm	3 mm	1
37218	50 mm	50 mm	4 mm	1

DREVENÝ OMIETNIK



Č.p.	dĺžka/length	hrúbka/thickness	šírka/width	
37120	200 mm	1,7 mm	20 mm	10
37119	250 mm	1,7 mm	20 mm	10

MOQ
10



10

10

SIĚŤ NA LEŠENIE



Č.p.	špecifikácia		
42120	2,5 x 20 m, 80 g/ m ²	zelená	5

VLÁKNO VÝSTUŽNÉ DO BETÓNU 0,9KG



- +/- 150 g/ 50 kg cementu
- 600 - 900 g/m² betónu alebo malty

Č.p.	špecifikácia	
42115	0,9 kg	9

KRYT OTVORU MAGNETICKÝ



Č.p.	špecifikácia	
82101	35 x 35 cm SDK	1
82104	63 x 63 cm SDK	1
82105	25 x 25 cm murivo	1
82109	63 x 63 cm murivo	1

SKOBA MURÁRSKA KOVANÁ

Zn



Č.p.	špecifikácia	
37229	14,5 cm	10

SKOBA MURÁRSKA POZINKOVANÁ

Zn



Č.p.	špecifikácia	
37231	14 cm volne	10

SKOBA MURÁRSKA KOVANÁ



Č.p.	špecifikácia	
37232	14,5 cm	5

SKOBA MURÁRSKA, SADA

6x



Č.p.	špecifikácia	
37230	16 cm	6

KRAMĽA POZINKOVANÁ

Zn



Č.p.	špecifikácia	
37233	320 x 10 mm	100
37234	320 x 12 mm	100

KRAMĽA



Č.p.	špecifikácia	
37235	250 x 12 mm	1



PB HORÁKY

PB HORÁK - SADA



· Ø 17, 22, 40 mm

Č.p. špecifikácia
69918 2 kW, 1,5 m hadica



10

PB HORÁK - SADA



· Ø 25, 35, 50 mm

Č.p. špecifikácia
69919 19,5 kW, 1,5 m hadica



10

PB HORÁK - SADA



· Ø 55 mm

Č.p. špecifikácia
69904 60 kW, 850 mm, 5 m hadica



8

SPÁJKOVACIA SÚPRAVA 3 KW

FESTA

TÜVRheinland
AK 601423580004

Č.p.	špecifikácia
69914	300 mm + 2 m hadica

5

PB HORÁK

FESTA

TÜVRheinland
AK 601423580004

Č.p.	špecifikácia
69900	Ø 35 mm, dĺžka 300 mm, bez hadice
69901	Ø 35 mm, dĺžka 300 mm + 3 m hadica

10

5

PB HORÁK

FESTA

TÜVRheinland
AK 601423580004

Č.p.	špecifikácia
69902	Ø 55 mm, dĺžka 550 mm, bez hadice

10

PB HORÁK

FESTA

TÜVRheinland
AK 601423580004

Č.p.	špecifikácia
69903	Ø 55 mm, dĺžka 550 mm + 3 m hadica

10

PB HORÁK

FESTA

TÜVRheinland
AK 601423580004

Č.p.	špecifikácia
69905	Ø 55 mm, dĺžka 850 mm, bez hadice

10

PB HORÁK

FESTA

TÜVRheinland
AK 601423580004

Č.p.	špecifikácia
69906	Ø 55 mm, dĺžka 850 mm + 3 m hadica

5

PB HORÁK - SADA S REDUKČNÝM VENTILOM

FESTA



· redukčný ventil pre pripojenie 10 a 33 kg bomby

Č.p.	špecifikácia
69917	Ø 55 mm, dĺžka 850 mm + 3 m hadica 3 m



1

HADICA PRE PB HORÁK

FESTA



Č.p.	špecifikácia
69910	3 m s koncovkami
69911	5 m s koncovkami
69912	10 m s koncovkami



20

12

8

HORÁK PLYNOVÝ NA KARTUŠI SO ZÁVITOM

FESTA



· max. teplota: 1200 °C
 · výkon: 1,7 kW
 · priemer horáka: Ø 20 mm



Č.p.	špecifikácia
69930	piezo

HORÁK PLYNOVÝ NA PREPICHOVACIU KARTUŠ

FESTA



· max. teplota: 1200 °C
 · výkon: 1,7 kW
 · priemer horáka: Ø 20 mm



Č.p.	špecifikácia
69931	piezo

REDUKČNÝ VENTIL PROPÁN BUTÁN



Č.p. špecifikácia
69923 W 21,8; G 3/8; 4 bar

1

REDUKČNÝ VENTIL PROPÁN BUTÁN



výstupný tlak	4,0 bar
menovitý prietok	16 kg h
pripojenia - vstup	W 21,8 x 1 14" LH
pripojenie - výstup	G3 8" LH

Č.p. špecifikácia
69920

25

REDUKČNÝ VENTIL PROPÁN BUTÁN



vstupný tlak	25 bar
výstupný tlak	0,5 - 4,0 bar
menovitý prietok	16 kg h
pripojenia - vstup	W 21,8 x 1 14" LH
pripojenie - výstup	G3 8" LH

Č.p. špecifikácia
69907

1



JEDNOCESTNÝ UZATVÁRACÍ VENTIL



výstup G 3/8L, pre 2 kg PB fľašu

Č.p. špecifikácia
69928

1

REGULÁTOR TLAKU



Č.p. špecifikácia
69908 30 mBar, trň
69909 30 mBar, závit G 1/4L

1

1

MISKA NA SADRU



Č.p.	špecifikácia	
37121	kónická	1

MISKA NA SADRU



Č.p.	špecifikácia	
37122	nízka	1

MISKA NA SADRU



Č.p.	špecifikácia	
33275	nízka gumová	20



VEDRO POZINKOVANÉ

Zn



Č.p.	špecifikácia	
39000	5 l	40
39001	10 l	30
39002	12 l	20
39003	15 l	20

VEDRO MURÁRSKE



Č.p.	špecifikácia	
39005	5 l	1
39010	10 l	1
39012	12 l	1
39014	15 l s lievikom	1
39020	20 l	1
39021	20 l s lievikom	1



NÁDOBA PLAST - PRUŽNÁ



Č.p.	špecifikácia	
39192	30 l	20
39193	45 l	20



MURÁRSKA NÁDOBA KRUHOVÁ



Č.p.	špecifikácia	
39045	45 l Ø 54 x 27 cm	1
39065	60 l Ø 60 x 35 cm	1
39090	90 l Ø 66 x 35 cm	1



MURÁRSKA NÁDOBA OBLŹNIKOVÁ



Č.p.	špecifikácia	
39145	45 l 71 x 40 x 21 cm	1
39165	65 l 71 x 40 x 30 cm	1
39190	85 l 77 x 48 x 30 cm	1



KLADKA MURÁRSKA Z 500



Č.p.	špecifikácia	
26780	0,5 t A s hákom	1
26781	0,5 t B s okom	1
26782	0,5 t C s hákom a chráničom	1
26783	0,5 t D s okom a chráničom	1

FÓLIE ZMRŠŤOVACIE



Č.p.	šírka	dĺžka	hrúbka	
38095	500 mm	600 m	8 µm číra	1
38097	100 mm	150 m	20 µm číra	1
38096	500 mm	200 m	23 µm čierna	1

PE VREČIA NA SŤ
TRANSPARENTNÉ

Č.p.	šírka	dĺžka	hrúbka	objem	ks	
39194	500 mm	1100 mm	0,16 mm	100 l	1	10
39196	600 mm	1200 mm	0,16 mm	110 l	1	10
39198	700 mm	1100 mm	0,16 mm	120 l	1	10
39200	500 mm	1100 mm	0,20 mm	100 l	1	10
39202	600 mm	1200 mm	0,20 mm	110 l	1	10
39204	700 mm	1100 mm	0,20 mm	120 l	1	10



PE VREČIA NA SŤ ČIERNE



Č.p.	šírka	dĺžka	hrúbka	objem	ks	
39195	500 mm	1100 mm	0,16 mm	100 l	1	10
39197	600 mm	1200 mm	0,16 mm	110 l	1	10
39199	700 mm	1100 mm	0,16 mm	120 l	1	10
39201	500 mm	1100 mm	0,20 mm	100 l	1	10
39203	600 mm	1200 mm	0,20 mm	110 l	1	10
39205	700 mm	1100 mm	0,20 mm	120 l	1	10



VREČIA NA ODPAD



Č.p.	šírka	dĺžka	hrúbka	ks	
38060	700 mm	1100 mm	0,08 mm	10	1
38063	700 mm	1100 mm	0,10 mm	3	1
38065	700 mm	1100 mm	0,20 mm	3	1



VREČIA NA ODPAD



Č.p.	šírka	dĺžka	hrúbka	ks	
38050	500 mm	600 mm	0,04 mm	25	1
38052	600 mm	800 mm	0,04 mm	25	1
38054	700 mm	1100 mm	0,04 mm	25	1



PE VREČIA NA ODPAD

5x



FÓLIA HADICA, POLOHADICA



polohadica



Č.p.	šírka	dĺžka	hrúbka	
38055	1200 mm	1000 mm	0,08 mm	5

Č.p.	šírka	hrúbka	špecifikácia	
38089	1,2 m	0,1mm	150 bm polohadica	1

ÚVÄZOK FIXAČNÝ



1000x



Č.p.	špecifikácia	
42365	1,25 100 mm	1
42366	1,25 125 mm	1
42367	1,25 140 mm	1
42368	1,25 160 mm	1

VIAZAČ VRIEC



Č.p.	špecifikácia	
50052		12
50050		1

VIAZAČ VRIEC - RÁDLOVAČKA



Č.p.	špecifikácia	
50051		2

FÓLIA VÝSTRAŽNÁ - EL. VEDENIE



Č.p.	šírka	dĺžka	
38955	22 cm	20 m	1
38956	22 cm	50 m	1

FOLIA VÝSTRAŽNÁ - VODA



Č.p.	šírka	dĺžka	
38957	22 cm	20 m	1
38958	22 cm	50 m	1

FOLIA VÝSTRAŽNÁ - PLYN



Č.p.	šírka	dĺžka	
38959	22 cm	20 m	1
38960	22 cm	50 m	1

PÁSKA ALARMUJÚCA



Č.p.	špecifikácia	dĺžka	
38944	ZÁKAZ VSTUPU, SK	80 mm 250 m	8
38945	VSTUP ZAKÁZAN, CZ	80 mm 250 m	8

PÁSKA ALARMUJÚCA



Č.p.	dĺžka	
38948	80 mm 250 m	8

PÁSKA ALARMUJÚCA

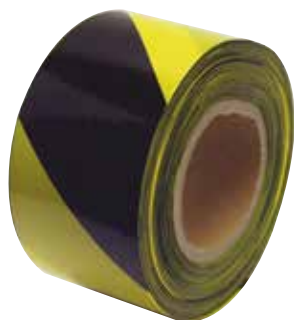

Č.p.	dĺžka	
38946	80 mm 250 m	8

PÁSKA ALARMUJÚCA - SAMOLEPIACA



Č.p.	dĺžka	špecifikácia	
38947	48 mm 33 m	pravá	48
38961	48 mm 33 m	ľavá	48

TRASOVACIA PÁSKA



Č.p.	šírka	dĺžka	hrúbka	
38949	50 mm	50 m	0,15 mm	36

BEZPEČNOSTNÁ SIEŤ

140
g/m²
UV
STABLE

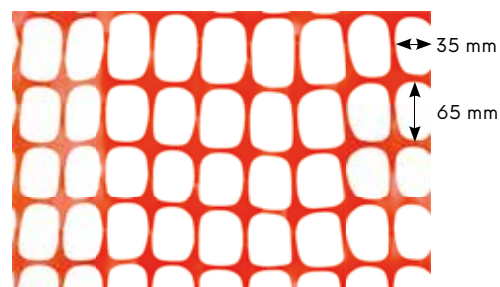

Č.p.	špecifikácia	
42190	1,2 x 50 m HDPE 140g/m ²	1

PÁSKY PVC

5x



Č.p.	šírka	dĺžka	hrúbka	
38931	19 mm	5 m	0,13 mm	100

PÁSKA PVC - ČIERNA



Č.p.	šírka	dĺžka	hrúbka	
38932	19 mm	10 m	0,13 mm	10

PÁSKA PVC



Č.p.	šírka	dĺžka	hrúbka	
38925	19 mm	10 m	0,13 mm	10

PÁSKA PVC - ČIERNA



Č.p.	šírka	dĺžka	hrúbka	
38968	19 mm	10 m	0,19 mm	10

PÁSKA TEXTIL ČIERNA



Č.p.	šírka	dĺžka	
38927	19 mm	10 m	10

PÁSKA TEXTILNÁ, KOBERCOVÁ



Č.p.	šírka	dĺžka	
38980	48 mm	10 m	24
38981	48 mm	20 m	24

PÁSKA LEPIACA OBOJSTRANNÁ S VÝSTUŽOU



Č.p.	šírka	dĺžka	
38924	50 mm	10 m	1
38964	50 mm	25 m	1

PÁSKA LEPIACA OBOJSTRANNÁ, POLYPROPYLÉN

PP
Polypropylén

Č.p.	šírka	dĺžka	
38929	50 mm	10 m	1
38966	50 mm	25 m	1

PÁSKA LEPIACA OBOJSTRANNÁ MONTÁŽNA

MADE IN
EU

Č.p.	šírka	dĺžka	
38990	19 mm	5 m	48
38991	25 mm	5 m	36

PÁSKA PROFESIONÁLNA ZOSILNENÁ, VODEODOLNÁ



Č.p.	šírka	dĺžka	
38995	48 mm	25 m	24

PÁSKA TEXTILNÁ, VODEODOLNÁ



Č.p.	šírka	dĺžka	
38965	30 mm	10 m	1
38928	50 mm	10 m	72
38934	50 mm	45 m	24

PÁSKA DUCT TAPE, VODEODOLNÁ



Č.p.	šírka	dĺžka	
37275	48 mm	50 m	24

PÁSKA FASÁDNA NA OMIETKU



Č.p.	šírka	dĺžka	
37271	38 mm	20 m	24
37270	48 mm	20 m	24
37272	48 mm	50 m	24

PÁSKA PE, VONKAJŠIA OCHRANA NA OKNÁ



po dobu 30 dní



Č.p.	šírka	dĺžka	
37273	48 mm	50 m	24

PÁSKA PROFI PAPIEROVÁ MASKOVACIA



Č.p.	šírka	dĺžka	
37263	38 mm	50 m	24
37264	48 mm	50 m	24

PÁSKA PVC MASKOVACIA



PÁSKA PAPIEROVÁ MASKOVACIA



PÁSKA BALIACA PVC



Č.p.	šírka	dĺžka	
37266	30 mm	33 m	60
37267	38 mm	33 m	48
37268	50 mm	33 m	36

Č.p.	šírka	dĺžka	
37255	19 mm	50 m	12
37256	25 mm	50 m	12
37257	30 mm	50 m	7
37258	38 mm	50 m	6
37259	50 mm	50 m	6

Č.p.	šírka	dĺžka	
38942	50 mm	50 m	72

PÁSKA POKOVOVANÁ

NEW

ALU

UV
STABLE

Č.p.	šírka	dĺžka	
38972	50 mm	50 m	1
38973	50 mm	100 m	1

FÓLIA HLINÍKOVÁ SAMOLEPIACA

ALU



Č.p.	šírka	dĺžka	
38963	48 mm	10 m	1
38943	48 mm	45 m	24

PÁSKA PROTIŠMYKOVÁ



Č.p.	šírka	dĺžka	hrúbka	
37280	25 mm	15 m	0,8 mm	72
37281	50 mm	15 m	0,8 mm	36

PÁSKA SAMOVULKANIZAČNÁ



Č.p.	šírka	dĺžka	
38930	19 mm	5 m	100

PÁSKA SADROKARTONÁRSKA SAMOLEPIACA

MADE IN
EU

Č.p.	šírka	dĺžka	
38935	50 mm	20 m	60
38937	50 mm	45 m	36
38939	50 mm	90 m	24
38940	50 mm	153 m	24

PÁSKA SKLOVLÁKNOVÁ

MADE IN
EU

Č.p.	šírka	dĺžka	
38941	50 mm	25 m	40

PÁSKA INŠTALATÉRSKA TEFLÓNOVÁ

TEFLON



Č.p.	šírka	dĺžka	hrúbka	
38969	19 mm	15 m	0,2 mm	10

PÁSKA INŠTALATÉRSKÁ TEFLÓNOVÁ

TEFLON



Č.p.	šírka	dĺžka	hrúbka	
38933	12 mm	10 m	0,075 mm	10

NÍŤ TEFLÓNOVÁ

TEFLON

· na vodo. a plyn. inštalácie



Č.p.	šírka	dĺžka	
38926	2 mm	150 m	20

ODVÍJAČ PÁSKY



Č.p.	
38985	1

VIAZACIA PÁSKA, SUCHÝ ZIPS



Č.p.	špecifikácia	
45471	12 mm x 5 m	1

PÁSKA NA SUCHÝ ZIPS, 3 KS

3x

FESTA



Č.p.	šírka	dĺžka	
37295	20 mm	150 mm	1
37296	20 mm	200 mm	1
37297	20 mm	250 mm	1

PIŠTOĽ VYTLÁČACIA ZOSILNENÁ



Č.p. 38013 špecifikácia

12

PIŠTOĽ VYTLÁČACIA



Č.p. 38001 špecifikácia

24

PIŠTOĽ VYTLÁČACIA



Č.p. 38012 špecifikácia

6

PIŠTOĽ VYTLÁČACIA

NEW



Č.p. 38024 špecifikácia

1

PIŠTOĽ VYTLÁČACIA SO SPÄTNÝM ODSKOKOM



Č.p. 38010 špecifikácia

6 hran

24

PIŠTOĽ VYTLÁČACIA



Č.p. 38025 špecifikácia

24

PIŠTOĽ VYTLÁČACIA NA CHEMICKÉ KOTVY 380 ML



Č.p. 38020 špecifikácia

12

PIŠTOĽ VYTLÁČACIA - KROKOVÁ



Č.p. 38006 špecifikácia

12

PIŠTOĽ VYTLÁČACIA

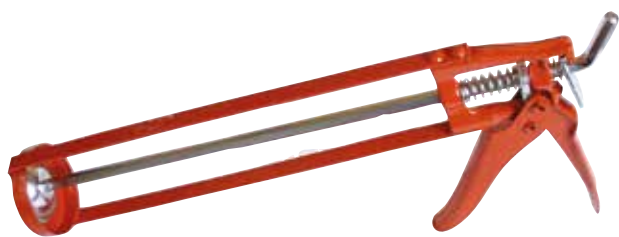

Č.p.	špecifikácia	
38002	6ti hran	24

PIŠTOĽ VYTLÁČACIA - PLASTOVÁ



Č.p.	špecifikácia	
38003	6ti hran	24

PIŠTOĽ VYTLÁČACIA



Č.p.	špecifikácia	
38007		24

PIŠTOĽ VYTLÁČACIA - PLASTOVÁ, POLOUZATVORENÁ



Č.p.	špecifikácia	
38008		24

PIŠTOĽ VYTLÁČACIA OZUBENÁ



Č.p.	špecifikácia	
38009		24

PIŠTOĽ VYTLÁČACIA



Č.p.	špecifikácia	
38000		24

PIŠTOĽ VYTLÁČACIA

FESTA

Č.p.	špecifikácia	
38005	310 ml	20
38014	špička 3 ks	100

PIŠTOĽ VYTLÁČACIA

FESTA

Č.p.	špecifikácia	
38004	600 ml	12
38014	špička 3 ks	100

PIŠTOĽ NA PU PENY S TEFLÓNOVÝM POVRCHOM

FESTA

TEFLON



20

Č.p. špecifikácia

38018

PIŠTOĽ NA PU PENY S TEFLÓNOVÝM POVRCHOM

FESTA

TEFLON



20

Č.p. špecifikácia

38017

PIŠTOĽ NA PU PENY

FESTA

TEFLON



20

Č.p. špecifikácia

38016

PIŠTOĽ NA PU PENY

FESTA

TEFLON



20

Č.p. špecifikácia

38015

PIŠTOĽ NA PU PENY

NEW



20

Č.p. špecifikácia

38031

PIŠTOĽ NA PU PENY ABS

FESTA



20

Č.p. špecifikácia

38022 ABS

PIŠTOĽ NA PU PENY



24

Č.p. špecifikácia

38021



TRYSKA NÁHRADNÁ NA PIŠTOĽ

TEFLON



PRE PIŠTOĽE 38015, 38016, 38017, 38018

Č.p. špecifikácia

38030



5

PIŠTOĽE ŠKÁROVACIA



objem 1,5 l

Č.p. špecifikácia

38026 5x špička



25

VRECE ŠKÁROVACIA



Č.p. špecifikácia

38042 3x špička



6

PIŠTOĽ TEPLOVZDUŠNÁ S REGULÁCIOU TEPLoty



FESTA



napätie / frekvencia	230V / 50Hz
príkion	2000W
poloha spínača	0 - I (350°C) - II (600°C)
príslušenstvo	nerezové nadstavce - 4 ks

Č.p. špecifikácia
35320 2000 W

1

PIŠTOĽ TEPLOVZDUŠNÁ S REGULÁCIOU TEPLoty A PRÚDU VZDUCHU



FESTA

digitálny display



napätie / frekvencia	230V / 50Hz
príkion	2000W
poloha spínača	0 - I (50°C) - II (50 - 600°C)
prúd vzduchu	250 - 500 l/min.
príslušenstvo	nerezové nadstavce - 4 ks

Č.p. špecifikácia
35322 2000 W

1



TAVNÉ PISTOLE

PIŠTOĽ TAVNÁ - BEZDRÔTOVÁ



· Ø tavné tyčinky 11,2 mm



Č.p. 89975 špecifikácia 80 W | 230 V



PIŠTOĽE TAVNÁ



· Ø tavné tyčinky 7,2 mm

Č.p. 89970 špecifikácia 15 W | 230 V



PIŠTOĽE TAVNÁ



· Ø tavné tyčinky 11,2 mm

Č.p. 89973 špecifikácia 60 W | 230 V



TYČINKY DO TAVNEJ PIŠTOĽE - ČÍRE

TYČINKY DO TAVNEJ PIŠTOĽE - ČÍRE

TYČINKY DO TAVNEJ PIŠTOĽE - FAREBNÉ



Č.p.	Ø tyčinky	dĺžka	ks	
89980	7,2 mm	100 mm	12 ks	100
89988	7,2 mm	100 mm	1 kg	25

Č.p.	Ø tyčinky	dĺžka	ks	
89985	11,2 mm	200 mm	10 ks	50
89987	11,2 mm	200 mm	1 kg	25

Č.p.	Ø tyčinky	dĺžka	ks	
89989	7,2 mm	100 mm	12 ks	100
89990	11,2 mm	200 mm	10 ks	50



ŠTETCE A VALČEKY

ŠTETEC PLOCHÝ NATUR



Č.p.	šírka	hrúbka	dĺžka	
52212	20 mm	15 mm	40 mm	12
52213	30 mm	15 mm	45 mm	12
52214	40 mm	15 mm	45 mm	12
52215	50 mm	15 mm	50 mm	12
52216	60 mm	15 mm	60 mm	12
52217	70 mm	15 mm	65 mm	12
52218	80 mm	15 mm	65 mm	12
52220	100 mm	15 mm	70 mm	12

ŠTETEC PLOCHÝ



Č.p.	šírka	hrúbka	dĺžka	
52202	20 mm	12,5 mm	38 mm	12
52203	30 mm	13 mm	38 mm	12
52204	40 mm	14 mm	44 mm	12
52205	50 mm	16 mm	44 mm	12
52206	60 mm	17 mm	52 mm	12
52208	80 mm	17 mm	52 mm	12
52207	100 mm	18 mm	52 mm	12

ŠTETEC ZÁROHOVÝ



Č.p.	šírka	hrúbka	dĺžka	
52283	25 mm	10 mm	44 mm	12
52284	38 mm	10 mm	44 mm	12
52285	50 mm	10 mm	44 mm	12
52286	62 mm	10 mm	50 mm	12
52288	76 mm	10 mm	50 mm	12

SADA ŠTETCOV - PLASTOVÁ RUKOVÄŤ

3x



Č.p.	špecifikácia	
52070	20, 30, 50 mm	50

SADA ŠTETCOV - PLASTOVÁ RUKOVÄŤ

5x



Č.p. špecifikácia

52071 15 mm, 25 mm, 40 mm, 60 mm, 80 mm

50

ŠKRABKA NA FARBY A LAKY



Č.p.

37005



12



MALIARSKA ŠTETKA PROFI



Č.p. špecifikácia

52075 Ø 90 mm



10

MALIARSKA ŠTETKA PROFI



Č.p. šírka dĺžka

52076 170 mm 80 mm



10

MALIARSKA ŠTETKA



Č.p. špecifikácia

52077 Ø 105 mm

dĺžka

70 mm



12

MALIARSKA ŠTETKA



Č.p. šírka

52078 170 mm

dĺžka

70 mm



12

TABUĽKA POUŽITIA MALIARSKYCH VALČEKOV		FARBY A LAKY												
MATERIÁL	VÝŠKA VLASU MM	DISPERZNÉ	ANTIÓROZNE	ŽIVICOVÉ	OLEJOVÉ	VODOU RIED.	POLYESTEROVÉ	POJIVOVÉ	LAZURY	LATEXOVÉ	EPOXYDOVÉ	2-KOMPO- NENTNÉ	HUSTÉ	AKRYLOVÉ
PES	20	•						•		•			•	
PES	20	•	•			•		•		•				•
PAC	18	•						•		•				
PAC	12, 13	•								•				
PAD	18, 21	•								•				
PAD	13	•	•							•				
BARÁNOK	23	•								•				
NYLON	13		•	•	•	•	•			•	•	•		
VELOUR	4		•	•			•				•	•	•	
MICROFIBRE	10					•			•	•				
MOLITAN				•		•								•



MALIARSKÉ VALČEKY

PENETRAČNÁ SÚPRAVA

MADE IN EU

PAC



č.p.

52600 polster 4



180 mm



Ø 8 mm



Ø 53 mm



18 mm



1

MALIARSKA SÚPRAVA - VESTAN

MADE IN EU

PES



č.p.

52610



180 mm



Ø 6 mm



Ø 42 mm



20 mm



25

52605

250 mm

Ø 6 mm

Ø 42 mm

20 mm

20

LAKOVACIA SÚPRAVA

MADE IN EU

- 1x valček PAD 13mm / 10 cm
- 1x valček PAC 12mm / 10 cm
- 1x valček PES 11mm / 10 cm
- držiak
- miska



č.p.

52602



10

VALČEK POLYAKRYL



PAC



Č.p.					
52331	100 mm	Ø 6 mm	Ø 17 mm	12 mm	50
52334	250 mm	Ø 8 mm	Ø 48 mm	12 mm	10

VALČEK POLYAKRYL



PAC



Č.p.					
52391	polster 5 250 mm	Ø 8 mm	Ø 54 mm	18 mm	10

VALČEK POLYAKRYL



PAC



Č.p.					
52328	polster 5 250 mm	Ø 8 mm	Ø 54 mm	18 mm	10
52456	polster 7 250 mm	Ø 8 mm	Ø 67 mm	18 mm	10

VALČEK POLYAMID



PAD



Č.p.					
52428	polster 7 250 mm	Ø 8 mm	Ø 67 mm	18 mm	10

VALČEK POLYESTER



PES



Č.p.					
52315	polster 5 180 mm	Ø 8 mm	Ø 54 mm	20 mm	10

VALČEK LAZÚROVACI - NYLON



PAD



Č.p.					
52421	100 mm	Ø 6 mm	Ø 17 mm	13 mm	50
52424	250 mm	Ø 8 mm	Ø 48 mm	13 mm	10

VALČEK POLYESTER



PES



Č.p.					
52305	180 mm	Ø 6 mm	Ø 42 mm	20 mm	10
52306	250 mm	Ø 6 mm	Ø 42 mm	20 mm	10

VALČEK LAKOVACÍ MOLITAN



Č.p.	rovný	100 mm	Ø 6 mm	Ø 35 mm	50

ROHOVÝ VALČEK POLYAKRYL



PAC



Č.p.	vrátane držiaka	Ø 6 mm	18 mm	1

TELESKOPICKÁ TYČ

ALU



Č.p.	dĺžka	ALU	50
52010	120 cm	ALU	50
52012	240 cm	ALU	25



TELESKOPICKÁ TYČ



Č.p.	dĺžka	ocel'	10
52020	300 cm	ocel'	10



TELESKOPICKÁ TYČ



Č.p.	dĺžka	fiberglass	6
52030	240 cm	fiberglass	6



MISKA



Č.p.	špecifikácia	100 mm	1
52662	150 x 270 mm	100 mm	1
52666	260 x 290 mm	180 mm	1
52671	330 x 340 mm	250 mm	1



VEDRO NA FARBU



Č.p.	objem	25	20
52694	8 l	25	
52695	12 l		20

MRIEŽKA



Č.p.	šírka	výška	
52652	230 mm	250 mm	100
52656	270 mm	290 mm	100

DRŽIAK



Č.p.	špecifikácia	
52640	5 cm Ø 6 mm	100
52645	8,5 cm Ø 6 mm x 27 mm	100

DRŽIAK



Č.p.	špecifikácia	
52630	18 cm Ø 6 mm	100
52635	25 cm Ø 6 mm	100
52620	18 cm Ø 8 mm	50
52625	25 cm Ø 8 mm	50

PÁSKA KRYCIA SAMOLEPIACA S FÓLIOU



Č.p.	šírka	dĺžka	
37243	55 cm	30 m	60
37244	110 cm	30 m	30
37245	140 cm	30 m	30
37246	180 cm	15 m	30
37290	210 cm	20 m	30
37247	240 cm	15 m	30
37291	270 cm	16 m	30

OCHRANNÁ KOMBINÉZA S KAPUCŇOU



Č.p.	špecifikácia	
50585	veľkosť M	1
50586	veľkosť L	1
50587	veľkosť XL	1
50588	veľkosť XXL	1

FÓLIA DO DVERÍ SO ZIPSOM



Č.p.	špecifikácia	
37248	1,2 x 2,2 m 100 µm páska 45 mm x 25 m	25

UNIVERZÁLNA KRYCIA FÓLIA



Č.p.	špecifikácia	hrúbka	
37250	4 x 5 m	0,007 mm	100
37251	4 x 12,5 m	0,007 mm	50
37252	2 x 50 m	0,007 mm	20

UNIVERZÁLNA KRYCIA FÓLIA



Č.p.	špecifikácia	hrúbka	
37253	4 x 5 m	0,03 mm	100

LEPENKA VLNITÁ



Č.p.	šírka	dĺžka	
54008	1 m	10 m	1

EKONOMIK **

STANDARD ***

PROFI ****



- Zdvojené zvarené lemy s polypropylénovou šnúrou
- Strieborná vrstva pre zvýšený odraz slnečného žiarenia
- ALU oká po 1 m

NEPREMOKAVÁ PLACHTA EKONOMIK

· modrá



Č.p.	špecifikácia		Č.p.	špecifikácia	
25369	2 x 2 m	50	25374	4 x 6 m	5
25370	2 x 3 m	20	25376	5 x 8 m	5
25371	3 x 4 m	10	25378	6 x 10 m	2
25372	3 x 5 m	10	25379	8 x 12 m	2
25373	4 x 5 m	10	25380	10 x 15 m	2

NEPREMOKAVÁ PLACHTA STANDARD

· modro-strieborná



70 g/m²



Č.p.	špecifikácia		Č.p.	špecifikácia	
25155	2 x 2 m	50	25025	5 x 5 m	10
25006	2 x 3 m	50	25030	5 x 6 m	10
25009	3 x 3 m	35	25040	5 x 8 m	5
25012	3 x 4 m	20	25048	6 x 8 m	5
25015	3 x 5 m	10	25060	6 x 10 m	5
25016	4 x 4 m	10	25096	8 x 12 m	2
25020	4 x 5 m	10	25150	10 x 15 m	2
25024	4 x 6 m	10	25153	15 x 20 m	1

NEPREMOKAVÁ PLACHTA STANDARD

· zelená



70 g/m²



Č.p.	špecifikácia		Č.p.	špecifikácia	
25179	2 x 2 m	50	25184	4 x 6 m	10
25180	2 x 3 m	50	25186	5 x 8 m	5
25195	2 x 8 m	20	25188	6 x 10 m	5
25181	3 x 4 m	20	25189	8 x 12 m	2
25182	3 x 5 m	10	25190	10 x 15 m	2
25183	4 x 5 m	10			

PE NEPREMOKAVÁ PLACHTA PROFI

· modro-strieborná



140 g/m²



Č.p.	špecifikácia		Č.p.	špecifikácia	
25206	2 x 3 m	25	25240	5 x 8 m	4
25212	3 x 4 m	10	25248	6 x 8 m	3
25215	3 x 5 m	8	25260	6 x 10 m	3
25220	4 x 5 m	8	25296	8 x 12 m	2
25224	4 x 6 m	8	25350	10 x 15 m	1
25230	5 x 6 m	8			

PE NEPREMOKAVÁ PLACHTA PROFÍ

· zeleno-zelená



200 g/m²



Č.p.	špecifikácia		Č.p.	špecifikácia	
25160	2 x 3 m	15	25164	4 x 6 m	3
25171	NEW 2 x 8 m	1	25167	6 x 8 m	2
25162	3 x 5 m	5	25169	8 x 12 m	1
25163	4 x 5 m	4	25170	10 x 15 m	1

PE NEPREMOKAVÁ PLACHTA OKRÚHLA

· modro-strieborná



120 g/m²



Č.p.	špecifikácia	
25003	Ø 3,6 m	15
25004	Ø 4,5 m	5
25005	Ø 5,5 m	4
25002	Ø 6,5 m	3

NEPREMOKAVÁ PLACHTA MASKOVACIA

· maskovacia



80 g/m²



Č.p.	špecifikácia	
25365	5 x 8 m	5
25366	6 x 10 m	2
25367	8 x 12 m	2
25368	10 x 15 m	2



NAPINÁK PLACHIET

4x



Č.p.	špecifikácia	
25400	20 cm	1

APLIKÁTOR ÔK DO PLACHIET



Č.p.	špecifikácia	
25410	aplikátor ôk + 25 ôk	1

OKÁ DO PE PLACHIET

10x



Č.p.	špecifikácia	
25001		1





KARABÍNY, REŤAZE A OCEĽOVÉ LANÁ

NAPÍNACIA SKRUTKA

DIN 1480

Zn





Č.p.	špecifikácia		Č.p.	špecifikácia	
50100	5 x 70 mm	10	50104	12 x 200 mm	10
50101	6 x 90 mm	10	50106	16 x 230 mm	10
50102	8 x 125 mm	10	50108	20 x 220 mm	10
50103	10 x 150 mm	10			

KARABÍNA

DIN 5299 C

Zn





Č.p.	špecifikácia		Č.p.	špecifikácia	
51204	4 mm	10	51209	9 mm	10
51205	5 mm	10	51210	10 mm	10
51206	6 mm	10	51211	11 mm	10
51207	7 mm	10	51212	12 mm	10
51208	8 mm	10			

ČLÁNOK RAPID

Zn





Č.p.	špecifikácia		Č.p.	špecifikácia	
51241	4 mm	10	51245	8 mm	10
51242	5 mm	10	51246	10 mm	10
51243	6 mm	10	51247	12 mm	10
51244	7 mm	10			

S HÁK

Zn





Č.p.	špecifikácia		Č.p.	špecifikácia	
51271	3 mm	10	51275	7 mm	10
51272	4 mm	10	51276	8 mm	10
51273	5 mm	10	51278	10 mm	10
51274	6 mm	10			

MATICA OČKOVÁ

DIN 5820

Zn





Č.p.	špecifikácia		Č.p.	špecifikácia	
51320	6 mm	10	51324	14 mm	10
51321	8 mm	10	51325	16 mm	10
51322	10 mm	10	51327	20 mm	10
51323	12 mm	10			

SKRUTKA OČKOVÁ

DIN 5820

Zn



Č.p.	špecifikácia		Č.p.	špecifikácia	
51300	6 mm	10	51305	16 mm	10
51301	8 mm	10	51306	18 mm	10
51302	10 mm	10	51307	20 mm	10
51303	12 mm	10	51308	22 mm	10
51304	14 mm	10			

SVORKA LANOVÁ

Zn



Č.p.	špecifikácia	
51280	3 mm	10
51281	5 mm	10
51282	6 mm	10
51283	8 mm	10

Č.p.	špecifikácia	
51284	10 mm	10
51286	12 mm	10
51287	14 mm	10
51288	16 mm	10

KARABÍNA OTOČNÁ

Zn



Č.p.	špecifikácia	
51220	53 mm	10
51221	67 mm	10
51222	76 mm	10

LANOVÁ SVORKA OTOČNÁ

Zn



Č.p.	špecifikácia	
51225	3,8 mm	10
51226	4,5 mm	10
51227	6,0 mm	10

REŤAZ KRÁTKE OKO

DIN 5685 A

Zn



Č.p.	veľkosť oka	dĺžka		Č.p.	veľkosť oka	dĺžka	
51402	2 x 10 mm	110 m	1	51406	6 x 24 mm	18 m	1
51403	3 x 16 mm	60 m	1	51407	7 x 50 mm	16 m	1
51404	4 x 21 mm	40 m	1	51408	8 x 32 mm	10 m	1
51405	5 x 23 mm	30 m	1	51410	10 x 39 mm	10 m	1

REŤAZ UZLOVÁ

DIN 5686

Zn



Č.p.	Ø drôtu	dĺžka		Č.p.	Ø drôtu	dĺžka	
51430	1,4 mm	150 m	1	51433	2,0 mm	118 m	1
51431	1,6 mm	150 m	1	51435	2,5 mm	70 m	1
51432	1,8 mm	150 m	1	51436	2,8 mm	50 m	1

REŤAZ DLHÉ OKO

DIN 5685 C

Zn



Č.p.	veľkosť oka	dĺžka		Č.p.	veľkosť oka	dĺžka	
51412	2 x 12 mm	80 m	1	51416	6 x 43 mm	18 m	1
51413	3 x 26 mm	60 m	1	51417	7 x 50 mm	16 m	1
51414	4 x 32 mm	38 m	1	51418	8 x 54 mm	10 m	1
51415	5 x 35 mm	32 m	1	51420	10 x 65 mm	10 m	1

REŤAZ PLASTOVÁ



Č.p.	špecifikácia	
51450	6 mm 25 m červeno-biela	1

SPOJKA LANOVÁ DVOJITÁ

DIN 5685 C

Zn



SPOJKA LANOVÁ

DIN 5685 C

Zn



Č.p.	špecifikácia	
51348	Ø 10 mm	10

Č.p.	špecifikácia		Č.p.	špecifikácia	
51338	Ø 5 mm	10	51341	Ø 10 mm	10
51340	Ø 8 mm	10			

OČNICA PRE LANÁ

Zn



Č.p.	špecifikácia	
51257	Ø 14 mm	10
51258	Ø 16 mm	10
51259	Ø 18 mm	10
51260	Ø 20 mm	10
51261	Ø 22 mm	10
51262	Ø 24 mm	10
51263	Ø 26 mm	10
51264	Ø 28 mm	10
51265	Ø 30 mm	10

LANKO OCEĽOVÉ POZINKOVANÉ

Zn



Č.p.	Ø	dĺžka	
51100	Ø 1 mm	500 m	1
51101	Ø 1,2 mm	500 m	1
51102	Ø 1,5 mm	500 m	1
51103	Ø 2 mm	200 m	1
51104	Ø 3 mm	200 m	1
51105	Ø 4 mm	100 m	1
51106	Ø 5 mm	75 m	1
51107	Ø 6 mm	75 m	1
51130	Ø 8 mm	75 m	1
51131	Ø 10 mm	50 m	1
51132	Ø 12 mm	50 m	1

LANKO OCEĽOVÉ POZINKOVANÉ V PVC OBALE

Zn



Č.p.	Ø	dĺžka	
51108	Ø 2/3 mm	200 m	1
51109	Ø 3/4 mm	100 m	1
51110	Ø 4/5 mm	75 m	1
51111	Ø 5/6 mm	50 m	1

LANKO OCEĽOVÉ NEREZOVÉ

INOX



Č.p.	Ø	dĺžka	
51120	Ø 1 mm	300 m	1
51121	Ø 1,2 mm	300 m	1
51122	Ø 1,5 mm	300 m	1
51123	Ø 2 mm	200 m	1
51124	Ø 3 mm	200 m	1
51125	Ø 4 mm	100 m	1
51126	Ø 5 mm	75 m	1
51127	Ø 6 mm	75 m	1

STOJAN NA LANKÁ A REŤAZE

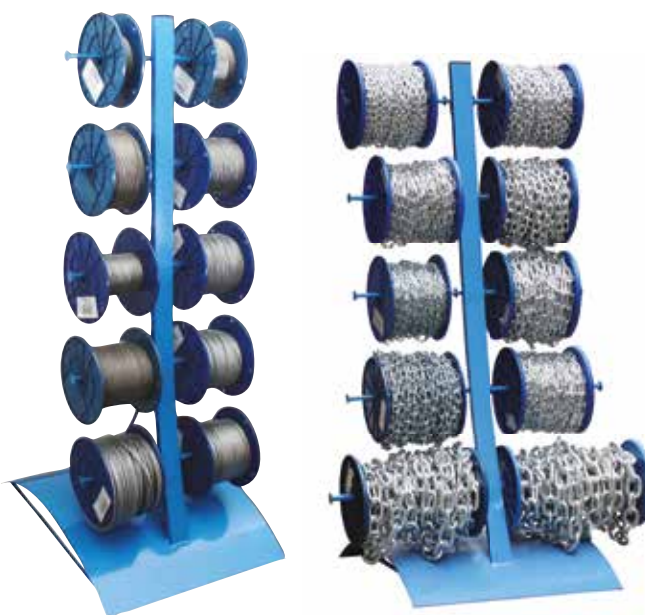

Č.p.	špecifikácia	
51196	Stojan na reťaze osadený	10
51197	Stojan na lanká osadený	10
51198	Stojan na reťaze	10
51199	Stojan na lanká	10

NAVIJAK S LANOM A HÁKOM

Zn



Č.p.	nosnosť	dĺžka lana	
26720	300 kg	8 m	1
26705	450 kg	8 m	1
26721	500 kg	8 m	1
26722	800 kg	8 m	1
26706	900 kg	8 m	1
26707	1350 kg	8 m	1

SVETLO STAVEBNÉ LED



20 W



Č.p.	špecifikácia
37611	1



SVETLO STAVEBNÉ HALOGÉNOVÉ



Č.p.	špecifikácia	
37600	120 W	1
37601	400 W	1

HALOGÉNOVÁ ŽIAROVKA



Č.p.	špecifikácia	
37604	120 W	1
37606	250 W	1
37605	400 W	1

SVETLO STAVEBNÉ LED



20 W



· maximálna výška 180 cm

Č.p.	špecifikácia	
37615	20 W	1
37616	2 x 20 W	1

SVETLO STAVEBNÉ HALOGÉNOVÉ

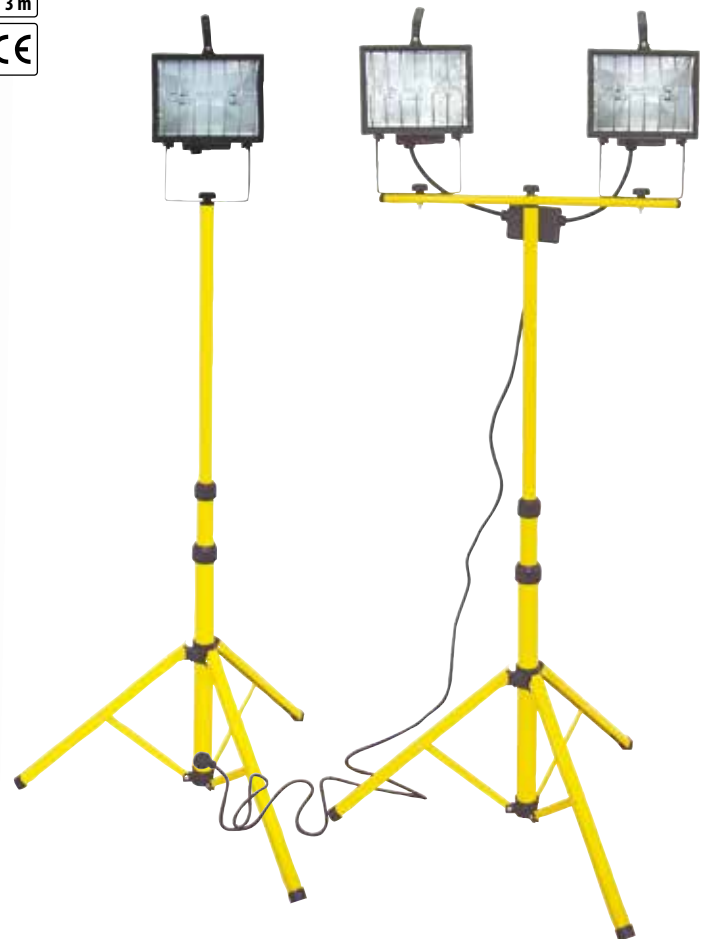

· maximálna výška 180 cm

Č.p.	špecifikácia	
37602	400 W	2
37603	2 x 400 W	2

REBRÍK TELESKOPICKÝ

ALU

CE EN
131

· max. nosnosť 150 kg

Č.p.	špecifikácia		
48410	3,2 m	11 priečok	1
48411	3,8 m	13 priečok	1

PLOŠINA PRACOVNÁ SKLADACIA

ALU



· max. nosnosť 150 kg

Č.p.	špecifikácia		
48420			1

TYČ ROZPÍNACIA, PODPERNÁ

FESTA



· max. nosnosť 40 kg

Č.p.	špecifikácia		
52060	66 - 115 cm		1
52065	160 - 290 cm		1

REBRÍK TELESKOPICKÝ SKLADACÍ

ALU

CE EN
131

· max. nosnosť 150 kg

Č.p.	špecifikácia		
48415	1,9 / 3,8 m	6/12 priečok	1

STOJKA DEBNIACA

MADE IN
EU

· 48449 klietka na debniace stojky

Č.p.	špecifikácia		
48452	160 - 290 cm		1
48453	180 - 320 cm		1
48454	200 - 360 cm		1
48455	250 - 440 cm		1
48456	260 - 380 cm		1
48457	220 - 400 cm		1

TYČ ROZPÍNACIA, PODPERNÁ



Č.p.	špecifikácia		
52050	50 - 115 cm		1
52055	115 - 290 cm		1

SKRUTKY DO DREVA, BOX

310x



ks	obsah balenia content
60	3,0 x 12 mm
50	3,0 x 16 mm
40	3,0 x 20 mm
50	3,5 x 20 mm
40	3,5 x 30 mm
25	4,0 x 30 mm
20	4,0 x 40 mm
15	5,0 x 50 mm
10	5,0 x 60 mm



Č.p.
55642

1

SKRUTKY DO DREVA + HMOŽDINKY, BOX

170x



skrutky do dreva

ks	obsah balenia content
40	3,5 x 30 mm
25	4,0 x 40 mm
12	5,0 x 50 mm
8	6,0 x 60 mm

hmoždinky

ks	obsah balenia content
40	5 x 25 mm
25	6 x 30 mm
12	8 x 40 mm
8	10 x 50 mm



Č.p.
55645

1

SKRUTKY DO DREVA, BOX

2000x



ks	obsah balenia content
350	3,0 x 16 mm
280	3,0 x 20 mm
220	3,0 x 25 mm
250	3,5 x 20 mm
240	3,5 x 25 mm
180	3,5 x 3, mm
280	4,0 x 16 mm
80	4,0 x 30 mm
40	4,0 x 40 mm
30	4,0 x 50 mm
25	5,0 x 50 mm
25	5,0 x 60 mm

Č.p. špecifikácia
55640 2000 ks



1

DVIERKA KOMÍNOVÉ PLECHOVÉ



DVIERKA KOMÍNOVÉ KOMAX



DVIERKA KOMÍNOVÉ ZINKOVANÉ



Č.p.
65062



1

Č.p. špecifikácia
65063 sivá
65064 biela



1

Č.p.
65065



1



294

WINLAND ZÁHRADNÍCKE NOŽNICE



298

ZÁHRADNÍCKE NOŽNICE



301

ZÁHRADNÉ PÍLY



302

MAČETY A ZÁHRADNÍCKE NÁRADIE



303

ZÁHRADNÍCKE NÁRADIE



305

STRUNY DO KOSAČKY



306

BRÚSKY

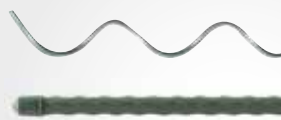

307

PARADAJKOVÉ A ZÁHRADNÉ TYČE



308

MULČOVACIE TEXTÍLIE



310

ZAVLAŽOVANIE AQUATIC, ROSA



322

VOZÍKY A DRŽIAKY NA HADICE



324

HADICOVÉ SPOJKY MOSADZ



326

HADICOVÉ SPOJKY



327

POSTREKOVAČE A KOMPRESORY



329

HRABLE



334

RÝLE, LOPATY A VIDLY



340

MOTYKY A KROMPÁČE



343

ZMETÁKY



346

ZHRŇOVAČE SNEHU



347

NÁSADY DREVENÉ, ALU A FIBERGLASS

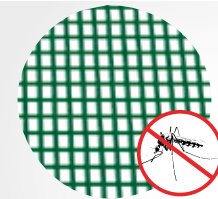

349

SIETE PROTI HMYZU

ZÁHRADNÉ NÁRADIE A PLETIVÁ

292 - 357

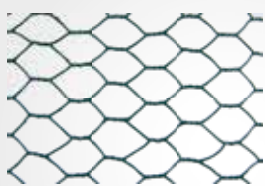

350

PLETIVÁ A VIAZACIE DRÔTY



352

KOTVIACE PÄTKY A ZEMNÉ SKRUTKY



354

TIENIACE TKANINY, TRSTINA, BAMBUS



355

GRILOVACIE NÁRADIE





ZÁHRADNÍCKE NOŽNICE

- Profesionálne záhradné nožnice
- Vysoká kvalita použitých materiálov
- Kvalitné spracovanie
- Ergonomické rukoväte

ZÁHRADNÍCKE NOŽNICE

SK5

- čepeľ HCS SK - 5, Japonská oceľ



Č.p.	špecifikácia	10
45020	205 mm	10
44980	Náhradná pružina	1

ZÁHRADNÍCKE NOŽNICE

SK5

- čepeľ HCS SK - 5, Japonská oceľ



Č.p.	špecifikácia	10
45023	205 mm	10
44980	Náhradná pružina	1

ZÁHRADNÍCKE NOŽNICE

SK5

- čepeľ HCS SK - 5, Japonská oceľ



Č.p.	špecifikácia	10
45063	215 mm	10
44981	Náhradná pružina	1

ZÁHRADNÍCKE NOŽNICE

SK5

- čepeľ HCS SK - 5, Japonská oceľ



Č.p.	špecifikácia	10
44972	215 mm	10
44981	Náhradná pružina	1

ZÁHRADNÍCKE NOŽNICE

SK5



Č.p.	špecifikácia
45099	190 mm
44983	Náhradná pružina

10
1

ZÁHRADNÍCKE NOŽNICE

SK5



Č.p.	špecifikácia
45098	220 mm
44983	Náhradná pružina

10
1

ZÁHRADNÍCKE NOŽNICE

SK5

TEFLON



Č.p.	špecifikácia
45095	200 mm
44982	Náhradná pružina

10
1

ZÁHRADNÍCKE NOŽNICE

SK5



- čepeľ HCS SK - 5, Japonská oceľ
- nylonová rukoväť

Č.p.	špecifikácia
45064	210 mm
44983	Náhradná pružina

10
1

ZÁHRADNÍCKE NOŽNICE

SK5

TEFLON

- otočná rukoväť



- čepeľ HCS SK - 5, Japonská oceľ

Č.p.	špecifikácia
45096	220 mm
44982	Náhradná pružina

6
1

ZÁHRADNÍCKE NOŽNICE

SK5

TEFLON



- čepeľ HCS SK - 5, Japonská oceľ

Č.p.	špecifikácia
45097	250 mm
44981	Náhradná pružina

10
1

ZÁHRADNÍCKE NOŽNICE

INOX



Č.p.	špecifikácia
45089	160 mm

10

ZÁHRADNÍCKE NOŽNICE

INOX



Č.p.	špecifikácia
45088	160 mm

10

ZÁHRADNÍCKE NOŽNICE PREDĽŽENÉ

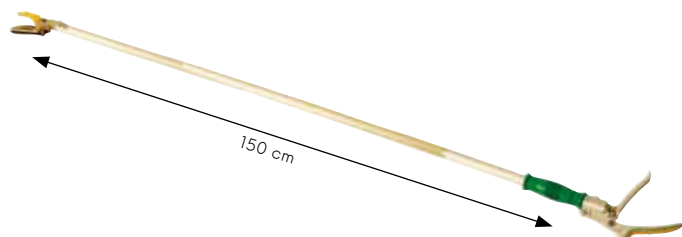

Č.p. špecifikácia
45017

10

NÁHRADNÝ BRIT



SK5

TEFLON



· pre nožnice 45095, 45027

Č.p. špecifikácia
45094

20

NOŽNICE NA KONÁRE



Ø max.
45mm

SK5

TEFLON



· čepeľ HCS SK - 5, Japonská oceľ

Č.p. špecifikácia
44991 76 cm



12

NOŽNICE NA KONÁRE TELESKOPICKÉ



Ø max.
45mm

SK5

TEFLON



· čepeľ HCS SK - 5, Japonská oceľ

Č.p. špecifikácia
44992 70 - 103 cm



10

NÁHRADNÁ PRUŽINA



Č.p.	pre nožnice	
44981	45021, 45025, 45063, 45097	1
44980	45020, 45023	1
44983	45098, 45099	1
44982	45027, 45095, 45096	1
44984	45110, 45014, 45026	1
44985	45018	1
44986	45019, 45029, 44970	1
44987	45021	1
44988	44971	1
44989	45015, 45016	1

NOŽNICE NA KONÁRE



NOŽNICE



TEFLON



Č.p. špecifikácia
44996 61 cm, vlnité ostrie



12

NOŽNICE

TEFLON



Č.p.	špecifikácia	
44997	61 cm, rovné ostrie	12

NOŽNICE NA TRÁVU OTOČNÉ 360°



Č.p.	špecifikácia	
44998		6

BRÚSIČ NA NOŽE A NOŽNICE 6 V 1



Č.p.	špecifikácia	
45068		10

BRÚSIČ NA NOŽE A NOŽNICE



Č.p.	špecifikácia	
45048		20

NOŽNICE

INOX



Č.p.	špecifikácia	
45010	190 mm	12
44984	Náhradná pružina	1

NOŽNICE

INOX



Č.p.	špecifikácia	
45014	190 mm	12
44984	Náhradná pružina	1

NOŽNICE

INOX



Č.p.	špecifikácia	
45026	150 mm	12
44985	Náhradná pružina	1

NOŽNICE ZÁHRADNÍCKE



Č.p.	špecifikácia	
45018	210 mm kované	10

ZÁHRADNÍCKE NOŽNICE

SK5

TEFLON



Č.p. špecifikácia
45019 210 mm



10

ZÁHRADNÍCKE NOŽNICE

FESTA

SK5

TEFLON

NYLON



· nylonová rukoväť
Č.p. špecifikácia
45021 200 mm



6

ZÁHRADNÍCKE NOŽNICE

ALU



Č.p. špecifikácia
45025 200 mm



12

ZÁHRADNÍCKE NOŽNICE

INOX



Č.p. špecifikácia
44970 210 mm



10

ZÁHRADNÍCKE NOŽNICE

TEFLON



Č.p. špecifikácia
45027 200 mm



10

ZÁHRADNÍCKE NOŽNICE

INOX

ALU



Č.p. špecifikácia
45029 200 mm



24

ZÁHRADNÍCKE NOŽNICE

INOX



Č.p. špecifikácia
44971 160 mm



10

ZÁHRADNÍCKE NOŽNICE



Č.p. špecifikácia
45016 180 mm



12

ZÁHRADNÍCKE NOŽNICE



Č.p. špecifikácia
45015 190 mm, rovné

12

PUZDRO NA ZÁHRADNÍCKÉ NOŽNICE



Č.p. špecifikácia
37317

1

NOŽNICE NA TRÁVU



Č.p. špecifikácia
45011 300 mm

1

NOŽNICE NA TRÁVU OTOČNÉ



Č.p. špecifikácia
45012 370 mm, otočné 180°

1



NOŽNICE NA KONÁRE



• nylonová rukoväť

Č.p. špecifikácia
44999 540 mm, oblé

12

NOŽNICE NA KONÁRE

TEFLON

FESTA



Č.p. špecifikácia
45000 750 mm, oblé

6

NOŽNICE NA KONÁRE

TEFLON

FESTA



Č.p. špecifikácia
45001 710 mm, oblé

6

NOŽNICE NA KONÁRE

FESTA

TEFLON



Č.p. špecifikácia
45002 750 mm, račňové

12

NOŽNICE NA KONÁRE TELESKOPICKÉ

FESTA

TEFLON



Č.p. špecifikácia
45003 660-900 mm, teleskopické

6

NOŽNICE

TEFLON

NYLON

Č.p. špecifikácia
44995 440 | 160 mm

12

NOŽNICE NA KONÁRE

FESTA

TEFLON



Č.p. špecifikácia
45005 580 | 230 mm, vlnité ostrie

6

NOŽNICE



Č.p. špecifikácia
45009 500 | 190 mm, vlnité ostrie

6

NOŽNICE

FESTA

TEFLON



Č.p. špecifikácia
45006 580 | 230 mm, rovné ostrie

6

NOŽNICE



Č.p. špecifikácia
45008 500 | 190 mm, rovné ostrie

6

NOŽNICE TELESKOPICKÉ

FESTA

TEFLON



Č.p. špecifikácia
45007 670-870 | 230 mm, vlnité ostrie

6

PÍLA ZATVÁRACIA



· 3 x brúsené a kalené zuby

Č.p. špecifikácia
45061 150 mm



12

PÍLA ZATVÁRACIA



· 3 x brúsené a kalené zuby

Č.p. špecifikácia
45060 180 mm



6

PÍLA S PUZDROM



· 3 x brúsené a kalené zuby

Č.p. špecifikácia
45062 260 mm



24

PÍLA PREREZÁVACIA



· 3 x brúsené a kalené zuby

Č.p. špecifikácia
24152 300 mm



12

PÍLA TELESKOPICKÁ PREREZÁVACIA



· 3 x brúsené a kalené zuby

Č.p. špecifikácia
45033 230 - 490 cm | 340 mm



1

HÚSENICA S PÍLKOU



Č.p. špecifikácia
45030 píłka 300 mm teleskopická tyč 240 cm 6
45031 píłka 300 mm 6

6
6

HÚSENICA



Č.p. špecifikácia
45032 kovová húsenica bez píľky 10

10



MAČETA

TEFLON



Č.p.	špecifikácia
45069	440 mm

6

FESTA®

MAČETA

TEFLON



Č.p.	špecifikácia
44950	490 mm

16

FESTA®

MAČETA NEREZ

INOX



Č.p.	špecifikácia
45083	430 mm
45084	600 mm

12

6

MAČETA



Č.p.	špecifikácia
45081	510 mm
45082	710 mm

36

36

· rukoväť vyrobená z jaseňového dreva

LOPATKA ŠIROKÁ NEREZ

INOX



Č.p. 45056
špecifikácia 360 mm



LOPATKA ÚZKA NEREZ

INOX



Č.p. 45057
špecifikácia 350 mm



MOTYČKA NEREZ

INOX



Č.p. 45058
špecifikácia 270 mm



VYPICHOVAČ BURINY S KOLÍSKOU, NEREZ

INOX



Č.p. 45059
špecifikácia 370 mm



LOPATKA ŠIROKÁ NYLON

NYLON



Č.p. 45065
špecifikácia 280 mm



LOPATKA ÚZKA NYLON

NYLON



Č.p. 45066
špecifikácia 310 mm



KULTIVÁTOR RUCNÝ NYLON

NYLON



Č.p. 45067
špecifikácia 290 mm



SADA NÁRADIA

HOBBY

4x



Č.p. 45035
špecifikácia 240 mm



KOLÍK SÁDZACÍ "T"



Č.p. špecifikácia
45038 280 mm

60

VYTRHÁVAČ BURINY



Č.p. špecifikácia
44955 950 mm

16

NOŽ ZA KOROV



Č.p. špecifikácia
45079 200 mm

1

NOŽ ZA KOROV



Č.p. špecifikácia
45080 200 mm „L“

1

LOPATKA SKLADACIA 3 V 1



Č.p. špecifikácia
61085 410 mm

25

SADZAČ CIBUĽOVÍN

INOX



Č.p. špecifikácia
45040 230 mm

60

ČESÁČIK NA OVOCIE



Č.p. špecifikácia
45041

75

ČESÁČIK NA OVOCIE





Č.p. špecifikácia
45039
45034 170 - 300 cm, teleskopická násada

50
5





STRUNA DO KOSAČKY



Č.p.	špecifikácia		
45500	1,3 mm x 15 m	●	30
45502	1,3 mm x 15 m	■	30
45503	1,6 mm x 15 m	★	20
45505	1,6 mm x 15 m	★	20
45506	2 mm x 15 m	●	12
45508	2 mm x 15 m	★	12
45517	2 mm x 15 m	■	10
45509	2,4 mm x 15 m	●	12
45511	2,4 mm x 15 m	★	12
45512	2,4 mm x 15 m	■	12
45518	2,4 mm x 15 m	■	10
45523	2,7 mm x 15 m	●	10
45524	2,7 mm x 15 m	★	10
45513	3 mm x 15 m	●	10
45515	3 mm x 15 m	★	10
45516	3 mm x 15 m	■	10
45519	3 mm x 15 m	■	10

STRUNA DO KOSAČKY S NYLONOVÝM STREDOM



Č.p.	špecifikácia		
45530	2 mm x 15 m	■	1
45531	2,4 mm x 15 m	■	1
45532	3 mm x 15 m	■	1
45533	3,15 mm x 15 m	■	1
45534	4 mm x 15 m	■	1

STRUNA DO KOSAČKY



Č.p.	špecifikácia		
45520	2 mm x 162 m	●	10
45521	2,4 mm x 112 m	●	10
45528	2,7 mm x 90 m	●	10
45522	3 mm x 72 m	●	10
45525	2 mm x 162 m	★	10
45526	2,4 mm x 112 m	★	10
45529	2,7 mm x 90 m	★	10
45527	3 mm x 72 m	★	10

BRÚSKA NA KOSU-OSLA



Č.p.	špecifikácia	
45046	205 x 15 mm	100

BRÚSIK OVÁLNA-OSLA



Č.p.	špecifikácia	
45370	250 x 33 x 18 mm	20

BRÚSKA-OSLA



Č.p.	špecifikácia	
45045	150 x 50 x 30 mm	50

BRÚSIČ NA NOŽE A NOŽNICE 6 V 1



Č.p.	špecifikácia	
45068		10

BRÚSIČ NA NOŽE A NOŽNICE



Č.p.	špecifikácia	
45048		20

BRÚSIČ NA NOŽE A NOŽNICE



Č.p.	špecifikácia	
16990	Ø 50 mm	50

BRÚSIČ NA NOŽE A NOŽNICE



Č.p.	špecifikácia	
16991		20

VIAZACIE PÁSKY

3x



Č.p.	špecifikácia	
45472	3 cm x 3 m, 3 ks	36

VIAZACIA PÁSKA



Č.p.	špecifikácia	
45473	3 cm x 50 m	60

VIAZACIA PÁSKA, SUCHÝ ZIPS



Č.p.	špecifikácia	
45471	12 mm x 5 m	1

DRÔT VIAZACÍ, PVC

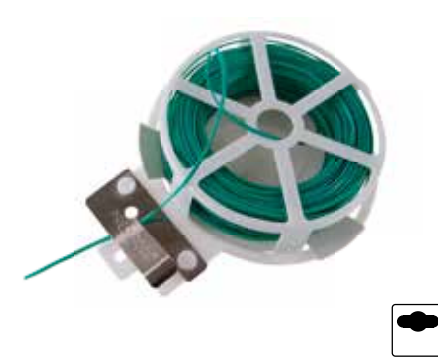

Č.p.	špecifikácia	
45043	30 m	30

DRÔT VIAZACÍ POGUMOVANÝ



Č.p.	špecifikácia	
23845	3 mm x 8 m	30
23846	4 mm x 6 m	30
23847	5 mm x 4 m	30

TYČ SKLOVLÁKNOVÁ



Č.p.	špecifikácia	
45036	180 cm Ø 7,9 mm	100

PÁSIK VIAZACÍ ZUBATÝ

50x



Č.p.	špecifikácia	
23840		20

TYČ ŠPIRÁLOVÁ K PARADAJKÁM



Č.p.	špecifikácia	
44041	1,2 m, Ø 5,5 mm komaxit - zelená	10
44042	1,5 m, Ø 6 mm komaxit - zelená	10
44043	1,8 m, Ø 6 mm komaxit - zelená	10
45049	1,8 m, Ø 7 mm komaxit - zelená	10
45044	1,8 m, Ø 7 mm komaxit - strieborná	10
44050	2,2 m, Ø 7 mm komaxit - zelená	10

SPOJKA PLASTOVÁ



Č.p.	špecifikácia	
45670	8 mm	10
45671	11 mm	10
45672	16 mm	10
45673	20 mm	10

TYČ ZÁHRADNÁ POPLASTOVANÁ



Č.p.	špecifikácia		Č.p.	špecifikácia		Č.p.	špecifikácia	
45650	90 cm Ø 8 mm	25	45655	150 cm Ø 11 mm	25	45659	180 cm Ø 16 mm	25
45651	120 cm Ø 8 mm	25	45656	180 cm Ø 11 mm	25	45660	210 cm Ø 16 mm	25
45652	150 cm Ø 8 mm	25	45661	210 cm Ø 11 mm	25	45662	150 cm Ø 20 mm	10
45653	90 cm Ø 11 mm	25	45657	120 cm Ø 16 mm	25	45663	180 cm Ø 20 mm	10
45654	120 cm Ø 11 mm	25	45658	150 cm Ø 16 mm	25	45664	210 cm Ø 20 mm	10



SIEŤ NA UHORKY

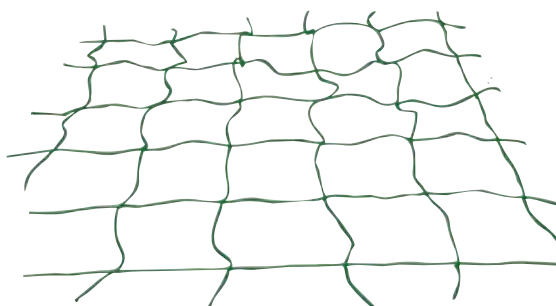

Č.p.	špecifikácia	veľkosť oka	
45560	2 x 10 m	10 x 10 cm	100

TEXTÍLIA NETKANÁ S VÝSEKMI NA VÝSADBU JAHÔD

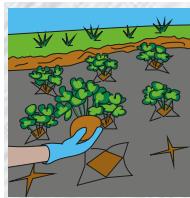
45 g/m²

Č.p.	špecifikácia	
45535	1,6 x 5 m	18

TEXTÍLIA NETKANÁ MULČOVACIA ČIERNA

50 g/m²

Č.p.	špecifikácia	
45550	1,6 x 5 m	50
45551	1,6 x 10 m	20
45564	3,2 x 10 m	20
45552	1,6 x 50 m	v rolke 1
45553	1,6 x 100 m	v rolke 1
45562	3,2 x 50 m	v rolke 1
45563	3,2 x 100 m	v rolke 1

TEXTÍLIA NETKANÁ MULČOVACIA HNEDÁ

50 g/m²

Č.p.	špecifikácia	
45556	1,6 x 5 m	50
45557	1,6 x 10 m	20
45565	3,2 x 10 m	20
45558	1,6 x 50 m	v rolke 1
45559	1,6 x 100 m	v rolke 1

TEXTÍLIA NETKANÁ BIELA

17 g/m²

Č.p.	špecifikácia	
45540	1,6 x 5 m	40
45541	1,6 x 10 m	40
45542	1,6 x 50 m	v roli 1
45543	1,6 x 100 m	v roli 1

KOLÍK KOTVIACÍ NA UPEVNENIE NETKANEJ TEXTÍLIE

10x



Č.p.	špecifikácia	
45555	11,5 cm	1

STOLIČKA ZÁHRADNÁ, SKLADACIA



• obojstranná - kľakadlo, sedátko

Č.p.	špecifikácia	
45074	58 x 48 x 28 cm	4

PODLOŽKA KĽAKACIA



Č.p.	špecifikácia	
45086	40 x 18 x 2 cm	50



KULTIVÁTOR



Č.p.	špecifikácia	
45042	160 x 132 cm	12

KULTIVÁTOR



Č.p.	špecifikácia	
44053		12
61251	160 cm násada	1

VOZÍK SYPACÍ

rozmery	
výška	111 cm
šírka	55 cm
objem zásobníka	12 l



Č.p.	špecifikácia	
45085	12 l	1

NÁDOBA PLAST - PRUŽNÁ



KÔŠ NA LÍSTIE, SKLADACIE



Č.p.	špecifikácia	
39192	30 l	20
39193	45 l	20



Č.p.	špecifikácia	
45047	55 x 70 cm, 3 držadlá	20

KÔŠ SKLADACÍ



Č.p.	špecifikácia	
45093	40 x 25 x 23 cm	20

VAK NA LÍSTIE



Č.p.	špecifikácia	
44960	200 l 60 x 60 x 55 cm	1

- PROFESIONÁLNY ZAVLAŽOVACÍ SORTIMENT
- KVALITNÉ MATERIÁLY A SPRACOVANIE
- MODERNÝ DIZAJN
- KOMPATIBILNÉ S RADOU PRODUKTU ROSA

FESTA®
AQUATIC



PIŠTOL'



FESTA®
AQUATIC



- 7 funkcií
- predná spúšť s poistkou
- ľahká regulácia prietoku

Č.p. špecifikácia

45386



12

PIŠTOL'



FESTA®
AQUATIC



- plynulá regulácia prúdu
- predná spúšť s poistkou
- ľahká regulácia prietoku

Č.p. špecifikácia

45388



12

ROZSTREKOVÁČ



FESTA®
AQUATIC



SADA S ROZSTREKOVÁČOM



FESTA®
AQUATIC



- plynulá regulácia prúdu

Č.p. špecifikácia

45389



24

- plynulá regulácia prúdu

Č.p. špecifikácia

45385

4 ks



12

SPOJKA

FESTA
AQUATIC

1/2"



Č.p. špecifikácia

45390 24



SPOJKA

FESTA
AQUATIC

3/4"



Č.p. špecifikácia

45391 24



RÝCHLOSPOJKA

FESTA
AQUATIC

1/2"



Č.p. špecifikácia

45392 24



RÝCHLOSPOJKA

FESTA
AQUATIC

3/4"



Č.p. špecifikácia

45393 24



STOP RÝCHLOSPOJKA

FESTA
AQUATIC

1/2"



Č.p. špecifikácia

45394 24



STOP RÝCHLOSPOJKA

FESTA
AQUATIC

3/4"



Č.p. špecifikácia

45395 24



ADAPTÉR

FESTA
AQUATIC

1/2"

3/4"



Č.p. špecifikácia

45396 24



ADAPTÉR

FESTA
AQUATIC

3/4"

1"



Č.p. špecifikácia

45397 24



ZAVLAŽOVAČ

- 2bar min
4bar max
- Max
27L/min
- 318m²

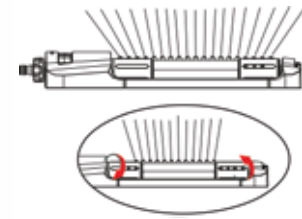

• 19 trysiek, z toho 8 vypínateľných



Č.p. špecifikácia
45398

6

ZAVLAŽOVAČ

- 4bar max
- Max
30L/min
- 360°
- R 6m
113m²

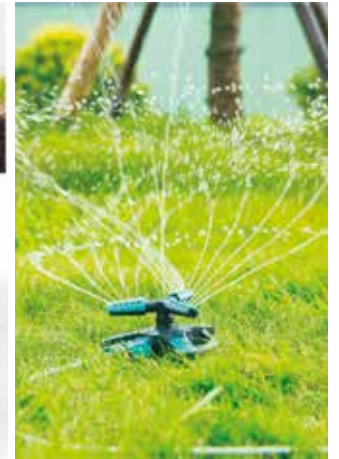

• nastaviteľné ramená s tryskami



Č.p. špecifikácia
45399

12

ROZDEĽOVAČ

- 3/4"
- 1"



• plynulá regulácia prietoku



Č.p. špecifikácia
45400 2 cestný

6

ROZDEĽOVAČ

- 3/4"
- 1"



• plynulá regulácia prietoku







Č.p. špecifikácia
45401 4 cestný

6



ROSA

Watering system

<p>PIŠTOĽ</p> <p>0,7 bar min 5,5 bar max</p>  <p> <ul style="list-style-type: none"> • 10 funkcií • predná spúšť s pojistkou </p> <p>Č.p. špecifikácia</p> <p>45124</p> <p>ROSA</p> <p>12</p>	<p>PIŠTOĽ</p> <p>0,7 bar min 5,5 bar max</p>  <p> <ul style="list-style-type: none"> • 10 funkcií • spúšť s pojistkou • ľahká regulácia prietoku </p> <p>Č.p. špecifikácia</p> <p>45125</p> <p>ROSA</p> <p>12</p>
<p>PIŠTOĽ</p> <p>0,7 bar min 5,5 bar max</p>  <p> <ul style="list-style-type: none"> • 7 funkcií • spúšť s pojistkou </p> <p>Č.p. špecifikácia</p> <p>45126</p> <p>ROSA</p> <p>12</p>	<p>PIŠTOĽ DELUX</p> <p>0,7 bar min 5,5 bar max</p>  <p> <ul style="list-style-type: none"> • 7 funkcií • spúšť s pojistkou • ľahká regulácia prietoku </p> <p>Č.p. špecifikácia</p> <p>45123 kovová</p> <p>ROSA</p> <p>12</p>
<p>PIŠTOĽ</p> <p>0,7 bar min 5,5 bar max</p>  <p> <ul style="list-style-type: none"> • 6 funkcií • spúšť s pojistkou • ľahká regulácia prietoku </p> <p>Č.p. špecifikácia</p> <p>45117</p> <p>ROSA</p> <p>12</p>	<p>PIŠTOĽ DELUX</p> <p>0,7 bar min 5,5 bar max</p>  <p> <ul style="list-style-type: none"> • 6 funkcií • spúšť s pojistkou • ľahká regulácia prietoku </p> <p>Č.p. špecifikácia</p> <p>45118 kovová hlavica</p> <p>ROSA</p> <p>12</p>

PIŠTOĽ

0,7 bar min
5,5 bar max

ROSA

- 5 funkcií
- spúšť s poistkou
- ľahká regulácia prietoku

Č.p. špecifikácia
45110

12

PIŠTOĽ

0,7 bar min
5,5 bar max

ROSA

- pištoľ ružicová
- ľahká regulácia prietoku

Č.p. špecifikácia
45116

12

PIŠTOĽ

0,7 bar min
5,5 bar max

ROSA

- kovová hlavica
- spúšť s poistkou
- ľahká regulácia prietoku

Č.p. špecifikácia
45120

12

PIŠTOĽ

0,7 bar min
5,5 bar max

ROSA

- spúšť s poistkou
- ľahká regulácia prietoku

Č.p. špecifikácia
45115

12

PIŠTOĽ

0,7 bar min
5,5 bar max

ROSA

- kovová
- spúšť s poistkou
- ľahká regulácia prietoku

Č.p. špecifikácia
45122 kovová

12

PIŠTOĽ SADA

0,7 bar min
5,5 bar max

1/2"

2x



ROSA

- spúšť s poistkou
- ľahká regulácia prietoku

Č.p. špecifikácia
45114 1/2 rýchlospojka

12

PIŠTOĽ

0,7 bar min
5,5 bar max

ROSA

- spúšť s poistkou
- ľahká regulácia prietoku

Č.p. špecifikácia
45111

12

ROZSTREKOVÁČ

0,7 bar min
5,5 bar max

ROSA

- plynulá regulácia prúdu

Č.p. špecifikácia
45113

60

ROZSTREKOVAČ

ROSA

0,7 bar min
5,5 bar max



· prúdnicový, klasické pripojenie



Č.p. špecifikácia

45112



32

PIŠTOL' SADA

ROSA

0,7 bar min
5,5 bar max



4x



· 6 funkcií
· spúšť s poistkou
· jednoduchá regulácia prietoku



Č.p. špecifikácia

45181



12

SÚPRAVA S ROZSTREKOVAČOM

ROSA

0,7 bar min
5,5 bar max



4x



· plynulá regulácia prúdu



Č.p. špecifikácia

45180



12

ROZDVOJKA - Y

ROSA

0,7 bar min
5,5 bar max



· s ventilom



Č.p. špecifikácia

45134



12

SPOJKA

ROSA

10 bar max



Č.p. špecifikácia

45140



60

SPOJKA

ROSA

10 bar max



MOQ 20



Č.p. špecifikácia

45296



MOQ 20

RÝCHLOSPOJKA

ROSA

10 bar max



Č.p. špecifikácia

45142



60

RÝCHLOSPOJKA

ROSA

10 bar max



MOQ 20



Č.p. špecifikácia

45298



MOQ 20

STOP RÝCHLOSPOJKA

ROSA



Č.p. špecifikácia
45138

60

STOP RYCHLOSPOJKA

ROSA



MOQ
20



Č.p. špecifikácia
45294

MOQ 20

SPOJKA

ROSA



Č.p. špecifikácia
45141

60

SPOJKA

ROSA



MOQ
20



Č.p. špecifikácia
45297

MOQ 20

RÝCHLOSPOJKA

ROSA



Č.p. špecifikácia
45143

60

RÝCHLOSPOJKA

ROSA



MOQ
20



Č.p. špecifikácia
45299

MOQ 20

STOP RÝCHLOSPOJKA

ROSA



Č.p. špecifikácia
45139

60

STOP RÝCHLOSPOJKA

ROSA



MOQ
20



Č.p. špecifikácia
45295

MOQ 20

ADAPTÉR

ROSA



Č.p.	špecifikácia	
45130	1/2" + 3/4"	60
45131	3/4" + 1"	60

ADAPTÉR

ROSA



MOQ
20



Č.p.	špecifikácia	
45289	1/2" + 3/4"	MOQ 20
45290	3/4" + 1"	MOQ 20

RÝCHLOSPOJKA SADA

ROSA



Č.p.	špecifikácia	
45144		60

REDUKCIA 1/2" - 3/4"

ROSA



Č.p.	špecifikácia	
45213	1/2" - 3/4"	60

SPOJOVACÍ VENTIL

ROSA



Č.p.	špecifikácia	
45135	s ventilom	60

ADAPTÉR

ROSA



Č.p.	špecifikácia	
45145		60

ADAPTÉR

ROSA



Č.p.	špecifikácia	
45132		60

ADAPTÉR

ROSA



MOQ
20



Č.p.	špecifikácia	
45291		MOQ 20

ADAPTÉR



ADAPTÉR



MOQ 20



Č.p. špecifikácia



45133

60

Č.p. špecifikácia



45292

MOQ 20

ADAPTÉR



ADAPTÉR



MOQ 20



Č.p. špecifikácia



45136

60

Č.p. špecifikácia



45293

MOQ 20

ADAPTÉR



ADAPTÉR



Č.p. špecifikácia



45137

60

Č.p. špecifikácia



45215

48

SPOJKA



RÝCHLOSPOJKA



Č.p. špecifikácia



45218

48

Č.p. špecifikácia



45219

48

REDUKCIA 3/4" - 1"

ROSA



Č.p. špecifikácia
45216

48

ADAPTÉR

ROSA



Č.p. špecifikácia
45217

48

PREDAJNÁ SADA

ROSA

225x



· obsah sady

45113	15 ks
45117	10 ks
45120	15 ks
45132	40 ks
45131	40 ks
45133	40 ks
45142	25 ks
45143	20 ks
45140	20 ks



Č.p. špecifikácia
45146

1

POSTREKOVACIA HUBICA

ROSA



· plynulá regulácia prúdu

Č.p. špecifikácia
45214

48

ZAVLAŽOVAČ IMPULZNÝ

ROSA



· impulzný

Č.p. špecifikácia
45162

24

ZAVLAŽOVAČ

ROSA



· 8 funkcií

Č.p. špecifikácia
45154

48

ZAVLAŽOVAČ

ROSA



· rotačný
· 2 ramená

Č.p. špecifikácia
45153

24

ZAVLAŽOVAČ

ROSA



· rotačný
· 3 ramená

Č.p. špecifikácia
45152

24

ZAVLAŽOVAČ VÝKYVNÝ

ROSA

0,7 bar min
5,5 bar max

ALU



· 17 trysiek

Č.p. špecifikácia

45158



6

ZAVLAŽOVAČ

ROSA

0,7 bar min
5,5 bar max

· pyramidový

Č.p. špecifikácia

45167



12

ZAVLAŽOVAČ

ROSA

0,7 bar min
5,5 bar max

· hrotový

Č.p. špecifikácia

45160



25

ZAVLAŽOVAČ

ROSA

0,7 bar min
5,5 bar max

· konvicový s ventilom

Č.p. špecifikácia

45156



12

PODSTAVEC PRE IMPULZNÝ ZAVLAŽOVAČ

ROSA

0,7 bar min
5,5 bar max

3/4"



Č.p. špecifikácia

45155



24

ZAVLAŽOVAČ IMPULZNÝ

ROSA

0,7 bar min
5,5 bar max

3/4"



· na trojnožke

Č.p. špecifikácia

45163 impulzný na trojnožke 20



20

ČASOVAČ

ROSA

0,7 bar min
5,5 bar max

3/4"



· 0 - 120 min.

Č.p. špecifikácia

45147



24

ZAVLAŽOVAČ IMPULZNÝ

ROSA

0,7 bar min
5,5 bar max

3/4"



· mosadzný

Č.p. špecifikácia

45150



12

ZAVLAŽOVAČ IMPULZNÝ

ROSA

0,7 bar min
5,5 bar max

3/4"



12

Č.p. špecifikácia
45151

ZAVLAŽOVAČ IMPULZNÝ, HROTOVÝ

ROSA

0,7 bar min
5,5 bar max

3/4"



12

Č.p. špecifikácia
45168 plastový hrot
45169 kovový hrot

12

ZAVLAŽOVAČ IMPULZNÝ, HROTOVÝ

ROSA

0,7 bar min
5,5 bar max



20

Č.p. špecifikácia
45161 plastový hrot

ZAVLAŽOVAČ ROTAČNÝ, HROTOVÝ

ROSA

0,7 bar min
5,5 bar max

3/4"



12

Č.p. špecifikácia
45164 plastový hrot

- 3 ramená
- dvojestný

HROTOVÝ PODSTAVEC

ROSA

Zn

3/4"



12

Č.p. špecifikácia
45159

HROTOVÝ PODSTAVEC

ROSA

3/4"



12

Č.p. špecifikácia
45179

VODIČ HADICE

ROSA



48

Č.p. špecifikácia
45186

ZAVLAŽOVAČ IMPULZNÝ

ROSA

1"



20

Č.p. špecifikácia
45185

ZAVLAŽOVAČ IMPULZNÝ

ROSA

3/4"



20

Č.p. špecifikácia
45184

SADA TESNENÍ



• pre položky

45110, 45111, 45118,
45120, 45121, 45123,
45125, 45126, 45130,
45131, 45132, 45134,
45135, 45152, 45153,
45154, 45155, 45156,
45162, 45177, 45178,
45180, 45196, 45197,
45198

Č.p. 45175
špecifikácia



1

TESNENIE NA SPOJKY A KONEKTORY



50x



Č.p. 45187
špecifikácia



1

DRŽIAK NA HADICU



Č.p. 45182
špecifikácia 1/2" 40 m



4

NAVÍJAČ NA HADICU



Č.p. 45176
špecifikácia



1

• vrátane hadice 1/2" 20 m

VOZÍK NA HADICU KOVOVÝ



VOZÍK NA HADICU



DRŽIAK NA HADICU



Č.p. 45183
špecifikácia 1/2" 60 m



5



Č.p. 45177
špecifikácia 1/2" 60 m



5



Č.p. 45178
špecifikácia 1/2" 60 m



5

SPRCHA

ROSA

0,7 bar min
5,5 bar max



Č.p.	špecifikácia	
45171	nastaviteľná	12

SPRCHA

ROSA

0,7 bar min
5,5 bar max



Č.p.	špecifikácia	
45170	3 nohy	6

SPRCHA - RUČNÁ

ROSA

0,7 bar min
5,5 bar max



Č.p.	špecifikácia	
45172	s ventilom	12
45173	10 funkcií	12

DRŽIAK HADÍC

ROSA



Č.p.	špecifikácia	
45174		60

HADICA ZÁHRADNÁ PRIEHLADNÁ



Č.p.	špecifikácia	
45345	1/2" 25 m	1
45349	3/4" 25 m	1
45353	1" 25 m	1

HADICA ZÁHRADNÁ NEPRIEHLADNÁ



Č.p.	špecifikácia	
45360	1/2" 25 m	1
45364	3/4" 25 m	1
45366	1" 25 m	1

ŠPIRÁLOVÁ HADICA - SADA

ROSA

0,7 bar min
5,5 bar max



Č.p.	špecifikácia	
45300	7,5 m	6
45301	15 m	8

NOSIČ HADÍC

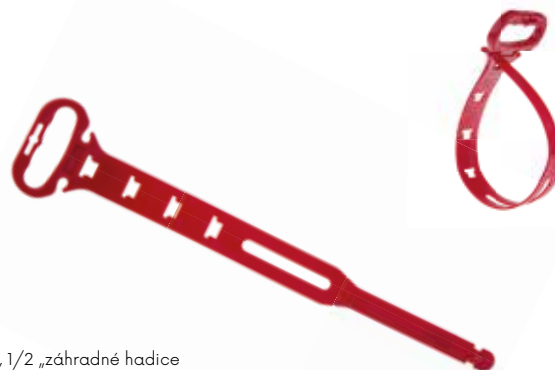

· max. 30 m, 1/2" záhradné hadice

Č.p.	špecifikácia	
45350	Max. nosnosť 20 kg	1

SPOJKA MOSADZ

ROSA



Č.p. špecifikácia

45192

48

RÝCHLOSPOJKA MOSADZ

ROSA



Č.p. špecifikácia

45194

48

STOP RÝCHLOSPOJKA MOSADZ

ROSA



Č.p. špecifikácia

45190

48

SPOJKA MOSADZ

ROSA



Č.p. špecifikácia

45193

48

RÝCHLOSPOJKA MOSADZ

ROSA



Č.p. špecifikácia

45195

48

STOP RÝCHLOSPOJKA MOSADZ

ROSA



Č.p. špecifikácia

45191

48

ADAPTÉR MOSADZ

ROSA



Č.p. špecifikácia

45196 s vnútorným závitom 1/2" + 3/4"

48

ADAPTÉR MOSADZ

ROSA



Č.p. špecifikácia

45197 s vnútorným závitom 3/4"

48

ADAPTÉR MOSADZ

ROSA



Č.p. špecifikácia

45199 s vnútorným závitom 1"

48

ADAPTÉR MOSADZ

ROSA



Č.p. špecifikácia

45198 s vnútorným závitom 3/4 + 1"

48

ADAPTÉR MOSADZ

ROSA



Č.p. špecifikácia

45200 s vonkajším závitom 3/4"

48

POSTREKOVACIA HUBICA MOSADZ

ROSA



Č.p. špecifikácia

45206 nastaviteľná

48

ADAPTÉR MOSADZ

ROSA



Č.p.	špecifikácia	
45203	medzikus pre 2 rýchlospojky	48

ADAPTÉR MOSADZ

ROSA



Č.p.	špecifikácia	
45204	medzikus pre 3 rýchlospojky	48

ADAPTÉR

MADE IN EU



Č.p.	špecifikácia	
45211	vnútorný závit 1"	25

HADICOVÁ SPOJKA



Č.p.	špecifikácia	
45220	1/2" závit 3/4"	10
45221	3/4" závit 1"	10
45222	1" závit 1"	10

HADICOVÁ KONCOVKA



Č.p.	špecifikácia	
45223	1/2" závit 3/4"	10
45224	3/4" závit 1"	10
45225	1" závit 1"	10

HADICOVÁ REDUKCIA



Č.p.	špecifikácia	
45226	1/2" - 3/4" závit 1"	10
45227	1" - 3/4" závit 1"	10
45228	1" - 1/2" závit 1"	10

ROZPRAŠOVAČ



Č.p.	špecifikácia	
45229		10

SPONA HADICOVÁ

Zn



Č.p.	priemer	
45603	16 - 25 mm	100
45604	20 - 32 mm	100
45605	25 - 40 mm	100
45606	30 - 45 mm	100
45607	32 - 50 mm	100
45608	40 - 60 mm	100
45609	50 - 70 mm	100
45610	60 - 80 mm	50
45611	70 - 90 mm	50
45612	80 - 100 mm	50
45613	90 - 110 mm	50
45614	100 - 120 mm	50
45615	110 - 130 mm	50
45616	120 - 140 mm	50
45617	130 - 150 mm	50
45618	140 - 160 mm	50
45619	150 - 170 mm	50

SPONA HADICOVÁ

INOX



Č.p.	priemer	šírka	
45623	16 - 25 mm	9 mm	100
45624	20 - 32 mm	9 mm	100
45625	25 - 40 mm	12 mm	100
45626	30 - 45 mm	12 mm	100
45627	32 - 50 mm	12 mm	100
45628	40 - 60 mm	12 mm	100
45629	50 - 70 mm	12 mm	100
45630	60 - 80 mm	12 mm	100
45631	70 - 90 mm	12 mm	100
45632	80 - 100 mm	12 mm	50
45633	90 - 110 mm	12 mm	50
45634	100 - 120 mm	12 mm	50
45635	110 - 130 mm	12 mm	50
45636	120 - 140 mm	12 mm	50
45637	130 - 150 mm	12 mm	50
45638	140 - 160 mm	12 mm	50
45639	150 - 170 mm	12 mm	50



VENTILY A ZAVLAŽOVACIE KRHLY

VENTIL ZÁHRADNÝ DVOJITÝ



Č.p.	špecifikácia	
45105		8

VENTIL ZÁHRADNÝ



Č.p.	špecifikácia	
45100	1/2"	12
45101	3/4"	10
45102	1"	6

VENTIL GULOVÝ



Č.p.	špecifikácia	
45106	1/2"	12
45107	3/4"	10
45108	1"	8

ROHÁČIK



Č.p.	špecifikácia	
45104	1/2" x 3/8"	12

KRHLA PLASTOVÁ



Č.p.	špecifikácia	
45280	2,5 l	10
45283	5 l	10
45285	10 l	10
45286	12 l	10
45287	15 l	10





POSTREKOVÁČ TLAKOVÝ ZÁHRADNÝ 12 L



max. tlak	2,5 Bar
objem	12 l
dĺžka hadice	3 m
rozmery	32 x 25 x 59 cm

Č.p.	špecifikácia	
45249	postrekovač tlakový záhradný 12 l	1
45273	pištoľ náhradná	1
45274	tlaková hadica náhradná	1

ČISTIČ VYSOKOTLAKOVÝ



napätie / frekvencia	230 V/50 Hz
príkion	1500 W
maximálny tlak	120 Bar
pracovný tlak	80 Bar
prietok vody	6 l
dĺžka hadice	5 m
krytie	IPX5
funkcie	Auto Stop

Č.p.	špecifikácia	
45270	čistič vysokotlakový	1
45271	pištoľ náhradná	1
45272	tlaková hadica náhradná	1

POSTREKOVÁČ TLAKOVÝ ZÁHRADNÝ



Č.p.	špecifikácia	
45247	12 l	1
45248	16 l	1

Č.p.	špecifikácia	
45263	náhradná hadička k postrekovaču	1
45251	náhradná sada tesnení	1
45254	náhradná tryska	1
45257	náhradná rukoväť	1
45260	náhradná tyč - 370 mm	1
45267	náhradná tyč 45 - 250 cm	1
45268	náhradná tyč 65 - 260 cm	1

POSTREKOVÁČ TLAKOVÝ ZÁHRADNÝ



Č.p.	špecifikácia	
45244	3 l	6
45245	5 l	6
45246	8 l	6

Č.p.	špecifikácia	
45262	náhradná hadička k postrekovaču	1
45250	náhradná sada tesnení	1
45253	náhradná tryska	1
45256	náhradná rukoväť	1
45261	náhradná tyč - 370 mm	1

POSTREKOVAČ RUČNÝ TLAKOVÝ

FESTA

POSTREKOVAČ RUČNÝ

MADE IN EU



Č.p.	špecifikácia	
45242	1,5 l	20
45241	2 l	20

Č.p.	špecifikácia	
45239	0,5 l	1
45240	0,7 l	1

TYČ K POSTREKOVAČU TELESKOPICKÁ

TYČ K POSTREKOVAČU TELESKOPICKÁ

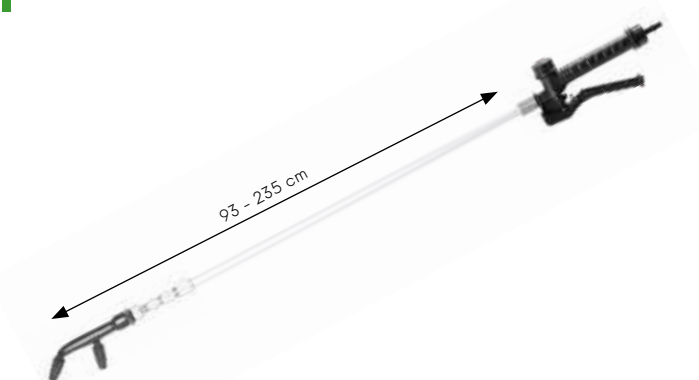

Č.p.	špecifikácia	
45267	45 - 250 cm inox	1
45268	65 - 260 cm fiberglass	1

Č.p.	špecifikácia	
45269		1

NÁHRADNÁ HADIČKA K POSTREKOVAČU

ČERPADLO PONORNÉ



Č.p.	špecifikácia	
45263	pre postrekovač 45247, 45248	1
45262	pre postrekovač 45244, 45245, 45246	1

príkon	400 W
napätie	230 V 50 Hz
typ ochrany	IPX 8
max. výtlak (výška)	5 m
max. prietok	8000 l h
veľkosť zrna	3,5 mm
max. hĺbka ponoru	7 m
max. teplota kvapaliny	35°C
pripojenie	1", G1", 1/4", G1/2"
dĺžka kábla	10 m

ZVON HERBICIDNÝ



Č.p.	veľkosť	dĺžka	šírka	výška	
45265	malý	230 mm	90 mm	130 mm	1
45266	veľký	370 mm	140 mm	200 mm	1

Č.p.	špecifikácia	
35350	400 W	1

FESTA®



HRABLE

HRABLE PLASTOVÉ



Č.p.	počet lamiel	šírka	výška	
45327	13	240 mm	200 mm	12

SET HRABLE PLASTOVÉ, HLINÍKOVÁ NÁSADA



Č.p.	počet lamiel	dĺžka	
61136	13	160 cm	3
61147	13	100 cm	3

HRABLE PLASTOVÉ



Č.p.	počet lamiel	šírka	výška	
45328	23	480 mm	280 mm	12

SET HRABLE PLASTOVÉ, HLINÍKOVÁ NÁSADA



Č.p.	počet lamiel	dĺžka	
61137	23	160 cm	3
61148	23	100 cm	3

HRABLE PLASTOVÉ



Č.p.	počet lamiel	šírka	výška	
45329	35	760 mm	310 mm	1

SET HRABLE PLASTOVÉ, HLINÍKOVÁ NÁSADA



Č.p.	počet lamiel	dĺžka	
61138	35	160 cm	3

HRABLE PLASTOVÉ

FESTA



Č.p.	počet lamiel	šírka	
45325	12	410 mm	12

SET HRABLE PLASTOVÉ, HLINÍKOVÁ NÁSADA

FESTA



Č.p.	počet lamiel	dĺžka	
61139	12	160 cm	3

MOQ
3

HRABLE PLASTOVÉ

FESTA



Č.p.	počet lamiel	šírka	
45326	18	580 mm	12

SET HRABLE PLASTOVÉ, HLINÍKOVÁ NÁSADA

FESTA



Č.p.	počet lamiel	dĺžka	
61140	18	160 cm	3

MOQ
3

ULICOVÝ ZMETÁK



Č.p.	špecifikácia	
45323	37 cm	16

SET ULICOVÝ ZMETÁK, NÁSADA



Č.p.	špecifikácia	dĺžka	
61149	37 cm	160 cm (45330)	3

MOQ
3

HRABLE KOVOVÉ NASTAVITEĽNÉ, TELESKOPICKÉ

FESTA

Zn



Č.p.	počet lamiel	rozsah	
44965	15	200 - 590 mm	12

HRABLE KOVOVÉ NASTAVITEĽNÉ

Zn



Č.p.	počet lamiel	váha	rozsah	
45050	15	1200 g	200 - 590 mm	25

HRABLE KOVOVÉ LAMELOVÉ

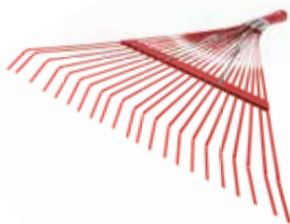

• pružinová ocel

Č.p.	šírka	počet lamiel	
45071	56 cm	22	1

HRABLE KOVOVÉ LAMELOVÉ, S NÁSADOU



MOQ
3

Č.p.	šírka	dĺžka	
61150	56 cm	160 cm	3

HRABLE KOVOVÉ LAMELOVÉ



Č.p.	šírka	počet lamiel	
45051	45 cm	22	60

HRABLE KOVOVÉ LAMELOVÉ, S NÁSADOU



MOQ
3

Č.p.	šírka	dĺžka	
61130	45 cm	160 cm	3

HRABLE KOVOVÉ DRÔTOVÉ



Č.p.	šírka	počet lamiel	
45052	45 cm	22	36

HRABLE KOVOVÉ S NÁSADOU



MOQ
3

Č.p.	šírka	dĺžka	
61131	45 cm	160 cm	3

HRABLE PLASTOVÉ



Č.p.	šírka	počet lamiel	
45320	60 cm	24	10

HRABLE PLASTOVÉ S NÁSADOU



MOQ
3

Č.p.	šírka	počet lamiel	dĺžka	
61132	60 cm	24	160 cm	3

HRABLE PLASTOVÉ



Č.p.	šírka	počet lamiel	
45055	50 cm	22	10

HRABLE PLASTOVÉ S NÁSADOU



MOQ
3

Č.p.	šírka	počet lamiel	dĺžka	
61133	50 cm	22	160 cm	3

HRABLE PLASTOVÉ



Č.p.	šířka	počet lamiel	
45321	40 cm	23	20

HRABLE PLASTOVÉ S NÁSADOU

MOQ
3

Č.p.	počet lamiel	délka	
61134	23	160 cm	3

HRABLE PLASTOVÉ



Č.p.	šířka	počet lamiel	
45054	40 cm	23	10

HRABLE PLASTOVÉ S NÁSADOU

MOQ
3

Č.p.	šířka	počet lamiel	délka	
61135	40 cm	23	160 cm	3

HRABLE PLASTOVÉ



Č.p.	šířka	počet lamiel	
45053	58 cm	16	35

HRABLE PLASTOVÉ S NÁSADOU

MOQ
3

Č.p.	šířka	počet lamiel	délka	
61141	58 cm	16	160 cm	3

HRABLE PLASTOVÉ, SO ZAROVNÁVACOU HRANOU



Č.p.	šířka	počet zubov	
45070	41 cm	14	4

HRABLE PLASTOVÉ, SO ZAROVNÁVACOU HRANOU, S NÁSADOU

MOQ
3

Č.p.	šířka	počet zubov	délka	
61142	41 cm	14	160 cm	3

HRABLE KOVOVÉ



Č.p.	šírka	počet zubov	
61030	24 cm	10	24
61031	29 cm	12	24
61032	34 cm	14	24
61033	40 cm	16	24

HRABLE KOVOVÉ S NÁSADOU



Č.p.	šírka	počet zubov	dĺžka	
61060	24 cm	10	160 cm	3
61061	29 cm	12	160 cm	3
61062	34 cm	14	160 cm	3
61063	40 cm	16	160 cm	3

MOQ
3

HRABLE VERTIKUTAČNÉ KOVOVÉ



· kladivkový lak

Č.p.	šírka	počet zubov	
61045	30 cm	12	25
61046	39 cm	14	25
61047	45 cm	16	25

HRABLE VERTIKUTAČNÉ KOVOVÉ S NÁSADOU



· kladivkový lak

Č.p.	šírka	počet zubov	dĺžka	
61143	30 cm	12	160 cm	3
61144	39 cm	14	160 cm	3
61145	45 cm	16	160 cm	3

MOQ
3

HRABLE VERTIKUTAČNÉ



Č.p.	šírka	počet zubov	
61048	35 cm	11 21	12

HRABLE VERTIKUTAČNÉ S NÁSADOU



Č.p.	šírka	počet zubov	dĺžka	
61146	35 cm	11 21	160 cm	3

MOQ
3



HRABLE KOVOVÉ S NÁSADOU, FIBERGLASS



Č.p.	šírka	počet zubov	dĺžka	
61034	34 cm	14	160 cm	3

MOQ
3

RÝLE
A
LOPATY

FESTA®

RÝĽ ŠPICATÝ MALÝ

FESTA®



· vhodný pre prácu v skleníku

Č.p.	špecifikácia	dĺžka	
61008	19 x 28 cm	85 cm	5

RÝĽ OBLÝ

FESTA®



Č.p.	špecifikácia	dĺžka	
61005	20 x 29 cm	120 cm	5

RÝĽ ŠPICATÝ

FESTA®



Č.p.	špecifikácia	dĺžka	
61006	19 x 28 cm	120 cm	5

RÝĽ OBLÝ, PREDĹŽENÝ

FESTA®



· pre postavy vyšší 180 cm

Č.p.	špecifikácia	dĺžka	
61157	20 x 29 cm	130 cm	5

RÝĽ ŠPICATÝ, PREDĹŽENÝ

FESTA®



· pre postavy vyšší 180 cm

Č.p.	špecifikácia	dĺžka	
61158	19 x 28 cm	130 cm	5

LOPATA STANDARD

FESTA®



Č.p.	špecifikácia	dĺžka	
61155	24 x 29 cm	120 cm	5

VÍDLE

FESTA®



Č.p.	špecifikácia	dĺžka	
61156	19 x 28 cm	130 cm	5

RYCIE VIDLY



RYCIE VIDLY, NÁSADA FIBERGLASS



Č.p.	špecifikácia	dĺžka	
61007	18 x 28 cm	130 cm	5



Č.p.	špecifikácia	dĺžka	
61010	18 x 30 cm	95 cm	12

RÝĽ ŠPICATÝ, NÁSADA FIBERGLASS

RÝĽ OBLÝ, NÁSADA FIBERGLASS



Č.p.	špecifikácia	dĺžka	
61029	19 x 30 cm	95 cm	12



Č.p.	špecifikácia	dĺžka	
61015	19 x 30 cm	95 cm	12

LOPATA HLINÍKOVÁ



LOPATA HLINÍKOVÁ S NÁSADOU



ALU

ALU



Č.p.	špecifikácia	
61026	26 x 29 cm	10
61025	34 x 30 cm	10

· buková násada kolienko



MOQ
3

Č.p.	špecifikácia	dĺžka	
61057	26 x 29 cm	130 cm	3
61056	34 x 30 cm	130 cm	3

LOPATA UHOĽNÁ

LOPATA UHOĽNÁ S NÁSADOU



Č.p.	špecifikácia	
61021	35 x 35 cm	10



MOQ
3

Č.p.	špecifikácia	dĺžka	
61089	35 x 35 cm	130 cm	3

LOPATA SRDCOVKA S NÁSADOU



- kladivkový lak
- buková násada kolienko

MOQ
3

Č.p.	špecifikácia	dĺžka
61050	26 x 28 cm	130 cm

3

LOPATA SRDCOVKA



- kladivkový lak

Č.p.	špecifikácia
61000	26 x 28 cm



12

LOPATA SRDCOVKA S NÁSADOU



- buková násada kolienko

MOQ
3

Č.p.	špecifikácia	dĺžka
61088	26 x 28 cm	130 cm

3

LOPATA SRDCOVKA



Č.p.	špecifikácia
61020	26 x 28 cm



12

LOPATA ŠTANDARD S NÁSADOU



- kladivkový lak
- buková násada kolienko

MOQ
3

Č.p.	špecifikácia	dĺžka
61051	24 x 29 cm	130 cm

3

LOPATA ŠTANDARD



- kladivkový lak

Č.p.	špecifikácia
61001	24 x 29 cm



12

LOPATA ŠTANDARD S NÁSADOU



- buková násada kolienko

MOQ
3

Č.p.	špecifikácia	dĺžka
61090	24 x 29 cm	130 cm
61053	24 x 29 cm	130 cm "T _n " násada

3

LOPATA ŠTANDARD



Č.p.	špecifikácia
61022	24 x 29 cm



12





LOPATA HOLŠTÝNSKA



Č.p.	špecifikácia	
61058	25 x 27 cm	12

LOPATA ÚZKA



- kladivkový lak

Č.p.	špecifikácia	
61002	19 x 27 cm	12

LOPATA ÚZKA



Č.p.	špecifikácia	
61024	19 x 27 cm	12

RÝĽ ŠPICATÝ



- kladivkový lak

Č.p.	špecifikácia	
61004	22 x 30 cm	12

LOPATA HOLŠTÝNSKA S NÁSADOU



- buková násada kolienko

MOQ
3

Č.p.	špecifikácia	dĺžka	
61059	25 x 27 cm	130 cm	3

LOPATA ÚZKA S NÁSADOU



- kladivkový lak
- buková násada kolienko

MOQ
3

Č.p.	špecifikácia	dĺžka	
61052	19 x 27 cm	130 cm	3

LOPATA ÚZKA S NÁSADOU



- buková násada kolienko

MOQ
3

Č.p.	špecifikácia	dĺžka	
61054	19 x 27 cm	130 cm	3

RÝĽ ŠPICATÝ S "T" NÁSADOU



- kladivkový lak

MOQ
3

Č.p.	špecifikácia	dĺžka	
61161	22 x 30 cm	90 cm	3

RÝĽ ŠPICATÝ S "T" NÁSADOU

MOQ
3

Č.p.	špecifikácia	dĺžka	
61097	19 x 30 cm	90 cm	3

RÝĽ ŠPICATÝ



Č.p.	špecifikácia	
61019	22 x 30 cm	12

RÝĽ KOVANÝ, ŠPICATÝ, S "T" NÁSADOU

MOQ
3

Č.p.	špecifikácia	dĺžka	
61162	22 x 25 cm	90 cm	3
61223	násada	90 cm	1

RÝĽ KOVANÝ, ŠPICATÝ



Č.p.	špecifikácia	
61013	22 x 25 cm	12

RÝĽ OBLÝ S "T" NÁSADOU

MOQ
3

Č.p.	špecifikácia	dĺžka	
61163	21 x 30 cm	90 cm	3

• kladivkový lak

RÝĽ OBLÝ



Č.p.	špecifikácia	
61003	21 x 30 cm	12

• kladivkový lak

RÝĽ OBLÝ S "T" NÁSADOU

MOQ
3

Č.p.	špecifikácia	dĺžka	
61098	21 x 30 cm	90 cm	3

RÝĽ OBLÝ



Č.p.	špecifikácia	
61018	21 x 30 cm	12





RÝĽ ŠTYCHAR



Č.p.	špecifikácia	
61014	14 x 37 cm	12

RÝĽ ŠTYCHAR S "T" NÁSADOU



Č.p.	špecifikácia	dĺžka	
61164	14 x 37 cm	90 cm	MOQ 3
61203	násada	90 cm	1

VIDLY NA SENO



Č.p.	špecifikácia	
61009	20 x 32 cm	12

VIDLY NA SENO S NÁSADOU



· buková násada kolienko

MOQ 3

Č.p.	špecifikácia	dĺžka	
61165	20 x 32 cm	90 cm	3

VIDLY RYCIE KOVANÉ



Č.p.	špecifikácia	
61012	22 x 30 cm	12

VIDLY RYCIE KOVANÉ S "T" NÁSADOU



Č.p.	špecifikácia	dĺžka	
61166	22 x 30 cm	90 cm	MOQ 3
61222	násada	90 cm	1

VIDLY RYCIE



Č.p.	špecifikácia	
61044	20 x 30 cm	12

VIDLY RYCIE S "T" NÁSADOU



Č.p.	špecifikácia	dĺžka	
61028	20 x 30 cm	90 cm	MOQ 3
61209	násada	90 cm	1

MOTYKA KOVANÁ, ŠPICATÁ, S NÁSADOU



Č.p.	špecifikácia	dĺžka	MOQ	
61111	0,4 kg	120 cm	3	3
61112	0,6 kg	120 cm	3	3
61224	násada	120 cm	1	1

MOTYKA PLOCHÁ, KOVANÁ, S NÁSADOU



Č.p.	špecifikácia	dĺžka	MOQ	
61114	0,6 kg	120 cm	3	3
61224	násada	120 cm	1	1

KROMPÁČ KOVANÝ S NÁSADOU



Č.p.	špecifikácia	dĺžka	MOQ	
61121	1,5 kg	95 cm	3	3
61042	2,5 kg	95 cm	3	3

MOQ
3

MOTYKA KOVANÁ, ŠPICATÁ

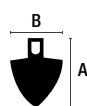

Č.p.	špecifikácia	A	B	
61035	0,4 kg	180 mm	125 mm	1
61036	0,6 kg	230 mm	160 mm	30

MOTYKA KOVANÁ, PLOCHÁ

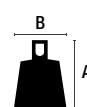

Č.p.	špecifikácia	A	B	
61038	0,6 kg	165 mm	135 mm	20

KROMPÁČ KOVANÝ



Č.p.	špecifikácia	
61120	1,5 kg	6
61040	2,5 kg	6



MOTYKA



Č.p.	špecifikácia	
61067	75 mm	1
61068	125 mm	1
61069	175 mm	1

MOTYKA S NÁSADOU



MOQ
3

Č.p.	špecifikácia	dĺžka	
61290	75 mm	120 cm	3
61291	125 mm	120 cm	3
61292	175 mm	120 cm	3

MOTYKA SRDCOVÁ



Č.p.	špecifikácia	
61070	140 mm	40

MOTYKA SRDCOVÁ S NÁSADOU



MOQ
3

Č.p.	špecifikácia	dĺžka	
61293	140 mm	120 cm	3

MOTYKA PLOCHÁ S NÁSADOU



Č.p.	špecifikácia	dĺžka	
61294	140 mm	27 cm	MOQ 3
61221	násada	27 cm	1

MOTYKA SRDCOVÁ S NÁSADOU



Č.p.	špecifikácia	dĺžka	
61295	140 mm	27 cm	MOQ 3
61221	násada	27 cm	1

MOTYKA PLEČKA S NÁSADOU



Č.p.	špecifikácia	dĺžka	
61296	175 mm	27 cm	MOQ 3
61221	násada	27 cm	1

KYPRIČ TROJ (3) HROTÝ S NÁSADOU



Č.p.	špecifikácia	dĺžka	
61297		27 cm	MOQ 3
61221	násada	27 cm	1

REKLAMNÝ STOJAN NA LOPATY A RÝLE



120 cm

80 cm



• ilustračné foto

Č.p.	špecifikácia	
61077	stojan osadený	1
61079	stojan na palete	1

DRŽIAK ZÁHRADNÉHO NÁRADIA



• ilustračné foto

Č.p.	špecifikácia	
51185	45 cm	5

DRŽIAK ZÁHRADNÉHO NÁRADIA

5x



• otočné gumové valčeky

Č.p.	špecifikácia	
51184		12

KOSÁK



Č.p.	špecifikácia	
45490	450 mm	1

KEFA OCEĽOVÁ



Č.p.	špecifikácia	
22135	6 x 19 cm bez násady	8
22137	6 x 19 cm s násadou 140 cm	MOQ 3

KEFA NYLONOVÁ



Č.p.	špecifikácia	
22136	6 x 19 cm bez násady	8
22138	6 x 19 cm s násadou 140 cm	MOQ 3

KEFA OCEĽOVÁ NA ČISTENIE ŠKÁR S NÁSADOU



Č.p.	dĺžka	
52198	140 cm	1

METLIČKA



Č.p.	špecifikácia	
52119	29 cm	24

METLIČKA S LOPATKOU



Č.p.	špecifikácia	
52168		26

METLIČKA S LOPATKOU



Č.p.	špecifikácia	
52175		26

LOPATKA PLECHOVÁ - ZOSILNENÁ



Č.p.	špecifikácia	
52176	22 x 23 cm	24

LOPATKA PLECHOVÁ

Zn

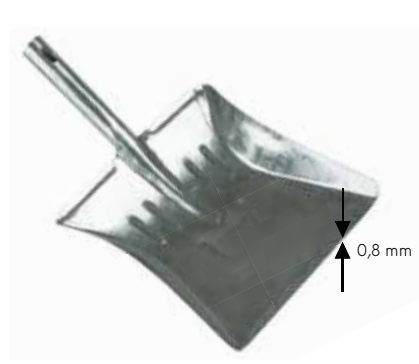

Č.p.	špecifikácia	
52175	22 x 23 cm	50

ULICOVÝ ZMETÁK S NÁSADOU

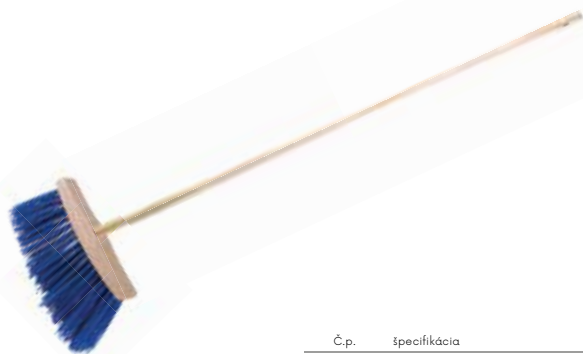

MOQ
3

Č.p.	špecifikácia			
52197	30 cm 120 cm	drevená	3	

ULICOVÝ ZMETÁK



Č.p.	špecifikácia		
52108	30 cm	hrubý závit	25
61172	násada 120 cm	hrubý závit	1

SET ULICOVÝ ZMETÁK S NÁSADOU



system click
ON - OFF



MOQ
3

Č.p.	špecifikácia	dĺžka	
61149	37 cm	160 cm	3

ULICOVÝ ZMETÁK



Č.p.	špecifikácia	
45323	37 cm	16

ULICOVÝ ZMETÁK S NÁSADOU



MOQ
3

Č.p.	špecifikácia	dĺžka	
52190	30 cm	150 cm	3
52191	40 cm	150 cm	3
52192	50 cm	150 cm	3
52193	60 cm	150 cm	3
52194	80 cm	150 cm	3

ULICOVÝ ZMETÁK

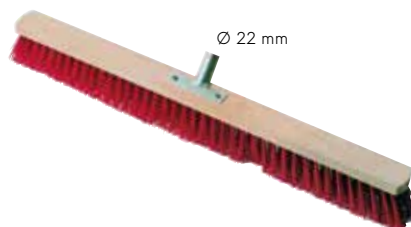

Č.p.	špecifikácia	
52101	30 cm	10
52102	40 cm	10
52103	50 cm	10
52104	60 cm	10
52105	80 cm	10

SÁLOVÝ ZMETÁK S NÁSADOU



MOQ
3

Č.p.	špecifikácia	dĺžka	
52185	40 cm	150 cm	3
52186	50 cm	150 cm	3
52187	60 cm	150 cm	3
52188	70 cm	150 cm	3
52189	80 cm	150 cm	3

SÁLOVÝ ZMETÁK



Č.p.	špecifikácia	
52160	40 cm	10
52161	50 cm	10
52162	60 cm	10
52163	70 cm	10
52164	80 cm	10

ZMETÁK



Č.p.	špecifikácia		
52114	28 cm	hrubý závit	1

ZMETÁK S NÁSADOU



MOQ
3

Č.p.	špecifikácia	dĺžka	
52116	28 cm	s násadou 130 cm	3

ZMETÁK



Č.p.	špecifikácia		
52113	30 cm	hrubý závit	26
52115	30 cm	bez závitú	26

ZMETÁK S NÁSADOU



MOQ
3

Č.p.	špecifikácia		
52196	30 cm	130 cm ALU	3
52195	30 cm	150 cm drevená	3

STIERKA S GUMOU



Č.p.	špecifikácia		
15886	450 mm	násada Ø 23 mm	48
15887	600 mm	násada Ø 23 mm	48
15888	750 mm	násada Ø 23 mm	32

ULICOVÝ ZMETÁK S NÁSADOU



Č.p.	špecifikácia		
52109	25 cm	120 cm drevená	12

NÁHRADNÝ MOP



Č.p.		
52111	30 cm	1

ČISTIACI MOP



Č.p.		
52110	30 cm	16



ZHRŇOVAČE SNEHU

ZHRŇOVAČ SNEHU

FESTA

ZHRŇOVAČ SNEHU

FESTA



Č.p.	špecifikácia	
60006	46 x 34 cm	12
60206	46 x 34 cm, zložený	1

Č.p.	špecifikácia	
60008	50 x 34 cm	12
60208	50 x 34 cm, zložený	1

ZHRŇOVAČ SNEHU

MADE IN
EU

ZHRŇOVAČ SNEHU

ALU



Č.p.	špecifikácia	
60001	48 x 40 cm	10
60201	48 x 40 cm, zložený	1

Č.p.	špecifikácia	
60012	50 x 38 cm	12
60212	50 x 38 cm, zložený	1

SEKÁČ NA ĽAD



MOQ
3

Č.p.	špecifikácia
60022	20 cm

3

SEKÁČ NA ĽAD

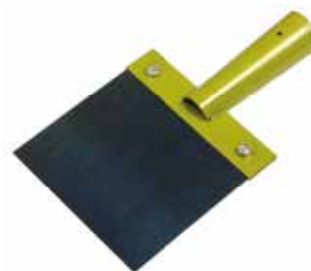

Č.p.	špecifikácia	
60018	15 cm	20
60019	20 cm	24
60020	30 cm	20
61201	násada 130 cm	10

POSYPOVÁ SOĽ



Č.p.	špecifikácia
43300	10 kg
43301	25 kg

1

1

NÁSADA NA ZMETÁK



Č.p.	špecifikácia	
61172	120 cm drevená násada s hrubým závitom	1
61192	150 cm drevená násada s hrubým závitom pro 52195	1
61193	150 cm drevená násada s hrubým závitom pro 52185 - 94	1
61194	140 cm drevená násada s hrubým závitom	1

NÁSADA NA ZMETÁK



ALU



Č.p.	špecifikácia
52125	130 cm, jemný závit
52126	130 cm, hrubý závit

1

1

NÁSADA NA ZMETÁK



Č.p.	špecifikácia		Č.p.	špecifikácia	
61171	1,2 m	1	61175	1,6 m	1
61173	1,4 m	1	61176	1,7 m	1
61174	1,5 m	1	61177	1,8 m	1

NÁSADA HLINÍKOVÁ

FESTA

ALU



Č.p.	špecifikácia
45330	161 cm
45331	100 cm

24

24

NÁSADA NA VIDLY A LOPATU - KOLIENKO



Č.p.	špecifikácia	
61200	130 cm	10

NÁSADA NA LOPATU



Č.p.	špecifikácia	
61201	130 cm, rovná	10

NÁSADA NA RÝĽ "T"



Č.p.	špecifikácia	
61208	90 cm	10

NÁSADA NA LOPATU "T"



Č.p.	špecifikácia	
61202	130 cm, rovná	10

NÁSADA NA MURÁRSKU NABERAČKU



Č.p.	špecifikácia	
61215	160 cm	10

NÁSADA NA RÝĽ "Y,"



Č.p.	špecifikácia	
61207	100 cm	10

NÁSADA NA KROMPÁČ FIBERGLASS



· na krompáč 2,5 kg 61040

Č.p.	špecifikácia	
61206	95 cm	1

NÁSADA NA KROMPÁČ



Č.p.	špecifikácia	
61204	95 cm, úzka (pre 61120)	10
61205	95 cm	10

NÁSADA NA PLASTOVÉ HRABLE



Č.p.	špecifikácia	
61195	120 cm	10

NÁSADA NA MOTYKU



Č.p.	špecifikácia	
61219	120 cm	10

NÁSADA NA HRABLE



Č.p.	špecifikácia	vhodné pre	
61250	160 cm	45051, 61048	20
61251	160 cm	45052	20
61252	160 cm	45320	20
61253	160 cm	45053	20
61254	160 cm	45054	20
61255	160 cm	45070	20
61256	160 cm	45055	20

NÁSADA NA ŽELEZNÉ HRABLE



Č.p.	špecifikácia	
61183	150 cm	10
61184	160 cm	10
61189	170 cm	10
61190	180 cm	10

PLASTOVÁ RÚČKA "Y" NA NÁSADU



Č.p.	špecifikácia	
61230		10



SIEŤ PROTI HMYZU

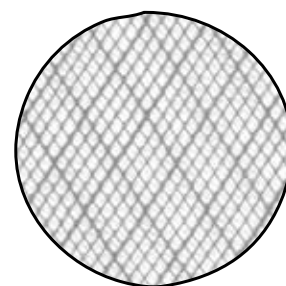

Č.p.	špecifikácia	
40100	1 x 25 m - PE biela	1
40120	1,2 x 25 m - PE biela	1

SIEŤ PROTI HMYZU

ALU

Zn

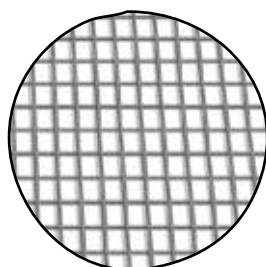

Č.p.	špecifikácia	
42101	1 x 30 m - ALUMINIUM	2
42103	1 x 30 m - galvanizovaný drôt	2

SIEŤ PROTI HMYZU

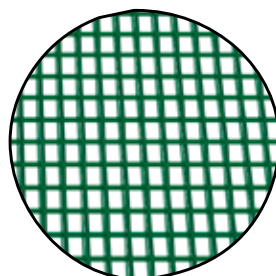

Č.p.	špecifikácia	
42102	1 x 30 m - zelený lakovaný oceľový drôt	2

DVERNÝ ZÁVES PROTI HMYZU



· variabilný rozmer 60 - 120 cm

Č.p.	špecifikácia	
40075	4 x 35 x 220 cm biela	20
40076	4 x 35 x 220 cm čierna	20

SIEŤ PROTI HMYZU - SKLOVLÁKNO

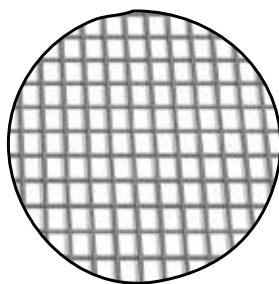

Č.p.	špecifikácia		
41083	0,8 x 30 m	biela	6
41103	1 x 30 m	biela	6
41123	1,2 x 30 m	biela	6
41153	1,5 x 30 m	biela	6

Č.p.	špecifikácia		
41082	0,8 x 30 m	biela-sivá	6
41102	1 x 30 m	biela-sivá	6
41122	1,2 x 30 m	biela-sivá	6
41152	1,5 x 30 m	biela-sivá	6

Č.p.	špecifikácia		
41050	0,5 x 30 m	sivá	6
41080	0,8 x 30 m	sivá	6
41100	1 x 30 m	sivá	6
41120	1,2 x 30 m	sivá	6
41150	1,5 x 30 m	sivá	6

Č.p.	špecifikácia		
41081	0,8 x 30 m	čierna	6
41101	1 x 30 m	čierna	6
41121	1,2 x 30 m	čierna	6
41151	1,5 x 30 m	čierna	6

OKENNÁ SIEŤ SO SUCHÝM ZIPSOM - BIELA



Č.p.	špecifikácia		
40050	150 x 130 cm	5,6 m	10
40052	150 x 180 cm	6,6 m	10
40054	150 x 90 cm	4,8 m	10
40056	220 x 75 cm 2 ks	5,8 m	10

OKENNÁ SIEŤ SO SUCHÝM ZIPSOM - ČIERNA



Č.p.	špecifikácia		
40057	150 x 130 cm	5,6 m	10
40058	150 x 180 cm	6,6 m	10
40059	150 x 90 cm	4,8 m	10

OKENNÁ SIEŤ SO SUCHÝM ZIPSOM - ŠEDÁ



Č.p.	špecifikácia		
40051	150 x 130 cm	5,6 m	10
40053	150 x 180 cm	6,6 m	10
40055	150 x 90 cm	4,8 m	10

SUCHÝ ZIPS SAMOLEPIACI PRE OKENNÉ SIETE



Č.p.	špecifikácia	
40060	9 mm 7 m	1

PLETIVO HEX

Zn



· zinkované pred spletením

Č.p.	špecifikácia	
42150	13 0,7 x 1000 mm - 50 m	1
42151	16 0,7 x 1000 mm - 50 m	1
42152	20 0,7 x 1000 mm - 50 m	1
42153	25 0,8 x 1000 mm - 50 m	1

PLETIVO HEX

Zn



Č.p.	špecifikácia	
42155	13 0,7 x 1000 mm - 50 m	1
42156	16 0,7 x 1000 mm - 50 m	1
42157	20 0,7 x 1000 mm - 50 m	1
42158	25 0,8 x 1000 mm - 50 m	1

PLETIVO HEX POPLASTOVANÉ

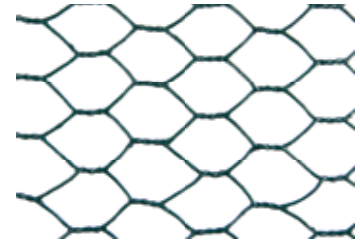

Č.p.	špecifikácia	
42160	13 1 x 1000 mm - 25 m	1
42161	16 1 x 1000 mm - 25 m	1
42162	20 1 x 1000 mm - 25 m	1
42163	25 1 x 1000 mm - 25 m	1

PLETIVO ŠTVOREC

Zn

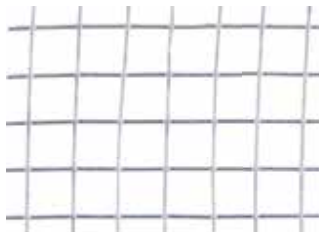

Č.p.	špecifikácia		Č.p.	špecifikácia	
42185	6 0,65 x 1000 mm - 25 m	1	42174	25 1,4 x 1000 mm - 25 m	1
42170	10 0,8 x 1000 mm - 25 m	1	42186	13 1,05 x 1000 mm - 25 m	1
42171	13 0,8 x 1000 mm - 25 m	1	42187	25 2,0 x 1000 mm - 25 m	1
42172	16 1,2 x 1000 mm - 25 m	1	42188	50 2,0 x 1000 mm - 25 m	1
42173	19 1,4 x 1000 mm - 25 m	1			

PLETIVO ŠTVOREC - POPLASTOVANÉ

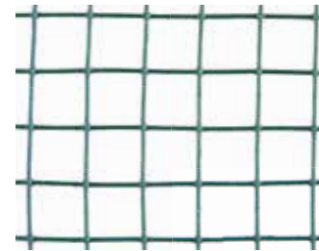

Č.p.	špecifikácia	
42180	13 1,2 x 1000 mm - 25 m	1
42181	16 1,2 x 1000 mm - 25 m	1
42182	25 2,3 x 1000 mm - 25 m	1

BEZPEČNOSTNÁ SIET'

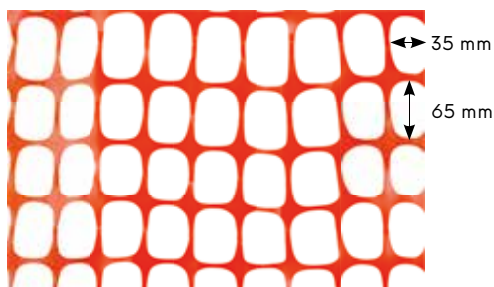
140
g/m²UV
STABLE

Č.p.	špecifikácia	
42190	1,2 x 50 m HDPE 140g/m ²	1

OKRASNÉ PLETIVO POPLASTOVANÉ



Č.p.	veľkosť oka	Ø drôtu	výška	dĺžka	
42175	15 x 9 mm	2 mm	40 cm	25 m	1
42176	15 x 9 mm	2 mm	65 cm	25 m	1
42177	15 x 9 mm	2 mm	90 cm	25 m	1
42178	15 x 9 mm	2 mm	120 cm	25 m	1
42179	15 x 9 mm	2 mm	25 cm	25 m	1

PLETIVO RABICOVÉ

Zn



Č.p.	špecifikácia	
42312	1 m 50 bm, 16 x 16 mm	1

SIET' PROTI VTÁKOM



Č.p.	špecifikácia	
45570	2 x 5 m 18 x 18 mm	45
45571	2 x 10 m 18 x 18 mm	28
45572	4 x 5 m 18 x 18 mm	24
45573	4 x 10 m 18 x 18 mm	15

MADE IN
EU

OCHRANA STROMOV PROTI OHRYZENIU

3x



· samosvorná

Č.p.	špecifikácia	
45580	Ø 11 x 80 cm	1

VIAZACÍ DRÔT

Zn



Č.p.	Ø drôtu	dĺžka drôtu	
42203	0,6 mm	30 m	50

DRÔT VIAZACÍ



Č.p.	Ø drôtu	dĺžka drôtu	povrch	
42201	0,6 mm	30 m	PVC	50
42202	0,9 mm	30 m	PVC	50

OSTNATÝ DRÔT

Zn



Č.p.	Ø drôtu	dĺžka drôtu	
42260	1,7 mm	50 m	1
42261	1,7 mm	100 m	1

VIAZACÍ DRÔT

Zn



Č.p.	Ø drôtu	dĺžka drôtu	
42207	0,8 mm	50 m	40
42208	0,8 mm	100 m	20
42209	0,9 mm	100 m	20
42240	1,0 mm	50 m	40
42210	1,0 mm	100 m	20
42211	1,2 mm	50 m	40
42212	1,2 mm	100 m	20
42213	1,4 mm	30 m	40
42214	1,4 mm	50 m	20
42217	1,8 mm	30 m	40
42218	1,8 mm	50 m	20

DRÔT VIAZACÍ



Č.p.	Ø drôtu	dĺžka drôtu	
42244	1,4 mm	50 m	20
42248	1,8 mm	50 m	20
42249	2,0 mm	50 m	20

SVORKA NAPÍNACIEHO DRÔTU

INOX



Č.p.	špecifikácia	
50040	nerez hrot, zelená	50
50041	nerez hrot, čierna	50

NAPÍNACÍ DRÔT

Zn



Č.p.	Ø drôtu	dĺžka drôtu	
42219	2,0 mm	26 m	20
42220	2,0 mm	52 m	20
42221	2,0 mm	78 m	20
42228	3,15 mm	26 m	10
42229	3,15 mm	52 m	10
42230	3,15 mm	78 m	10

DRÔT NAPÍNACÍ



Č.p.	Ø drôtu	dĺžka drôtu	
42251	2,6 mm	26 m	20
42252	2,6 mm	52 m	20
42253	2,6 mm	78 m	20
42255	3,4 mm	26 m	10
42256	3,4 mm	52 m	10
42257	3,4 mm	78 m	10

SVORKA NAPÍNACIEHO DRÔTU

10x



Č.p.	špecifikácia	
50042		10

PLOTOVÝ NAPINÁK MALÝ

Zn



Č.p.	špecifikácia	
50030	pozink malý	50
50032	PVC malý	50

PLOTOVÝ NAPINÁK VEĽKÝ

Zn



Č.p.	špecifikácia	
50031	pozink	50
50033	PVC	50

PLOTOVÝ NAPINÁK MALÝ LT

Zn



Č.p.	špecifikácia	
50037	pozink	50
50038	PVC	50

NAPÍNACIE ZARIADENIE



Č.p.	špecifikácia	
50035	2 t	6
50036	4 t	4

PÔDNÝ VRTÁK



Č.p.	Ø	A	B	
61299	110 mm	270 mm	1200 mm	1
61300	140 mm	270 mm	1200 mm	1
61301	170 mm	270 mm	1200 mm	1
61302	200 mm	270 mm	1200 mm	1

ZEMNÝ VRUT

Zn

6x

· redukcia

- Ø 24 mm
- Ø 35 mm
- Ø 40 mm
- Ø 48 mm
- Ø 55 mm



Č.p.	Ø pätky	dĺžka pätky	špecifikácia	
55450	60 mm	550 mm	1 ks + 5x redukcia	8

KOTVIACA PÄTKA STĹPIKA

Zn



Č.p.	rozmery pätky	dĺžka pätky	hrúbka materiálu	
55400	71 x 71 mm	750 mm	2 mm	1
55401	91 x 91 mm	750 mm	2 mm	1
55406	81 x 81 mm	750 mm	2 mm	1
55402	91 x 91 mm	900 mm	2 mm	1
55403	101 x 101 mm	900 mm	2 mm	1
55404	121 x 121 mm	900 mm	2 mm	1
55405	151 x 151 mm	900 mm	2 mm	1

KOTVIACA PÄTKA STĹPIKA

Zn



Č.p.	rozmery pätky	dĺžka pätky	hrúbka materiálu	
55420	71 x 71 mm	150 mm	2 mm	1
55425	81 x 81 mm	150 mm	2 mm	1
55421	91 x 91 mm	150 mm	2 mm	1
55422	101 x 101 mm	150 mm	2 mm	1
55423	121 x 121 mm	150 mm	2 mm	1
55424	151 x 151 mm	150 mm	2 mm	1

KOTVIACA PÄTKA STĹPIKA

Zn



Č.p.	rozmery pätky	dĺžka pätky	hrúbka materiálu		
55436	70 x 75 mm	110 mm	4 mm	10	Ø 18 x 200mm
55437	80 x 90 mm	130 mm	4 mm	10	

KOTVIACA PÄTKA STĹPIKA

Zn



Č.p.	rozmery pätky	dĺžka pätky	hrúbka materiálu		
55429	70 x 60 mm	100 mm	4 mm	10	Ø 18 x 200mm
55433	81 x 60 mm	100 mm	4 mm	10	
55430	91 x 60 mm	100 mm	4 mm	10	
55431	101 x 60 mm	100 mm	4 mm	10	
55432	121 x 60 mm	100 mm	4 mm	10	

ZEMNÝ VRUT "U"

Zn

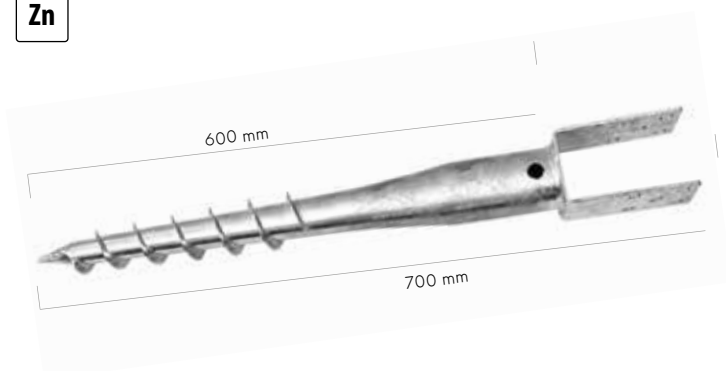

Č.p.	rozmery pätky	dĺžka pätky	hrúbka materiálu	
55455	71 x 60 mm	100 mm	4 mm	1
55452	81 x 60 mm	100 mm	4 mm	1
55456	90 x 60 mm	100 mm	4 mm	1
55453	101 x 60 mm	100 mm	4 mm	1
55457	110 x 60 mm	100 mm	4 mm	1
55454	121 x 60 mm	100 mm	4 mm	1

PÄTKA STĹPIKA S NASTAVITEĽNOU SKRUTKOU

Zn



Č.p.	rozmery pätky	výška pätky	závit	
55460	80 x 80 mm	150 mm	M16	10
55461	100 x 100 mm	150 mm	M16	10
55462	150 x 150 mm	150 mm	M24	10

BAMBUSOVÉ ZÁSTENY A TIENIACE TKANINY

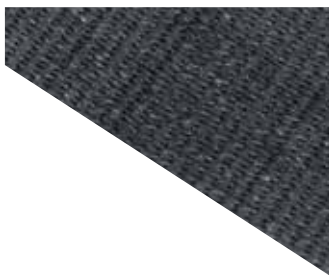
TIENIACA TKANINA HDPE 150 G / M² ANTRACIT150
g/m²

• tienenie 85%

Č.p.	špecifikácia	
45496	1 x 10 m	1
45497	1,5 x 10 m	1
45498	1,8 x 10 m	1
45499	2 x 10 m	1

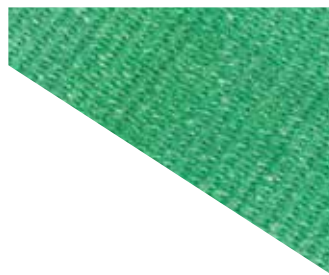
TIENIACA TKANINA HDPE 150 G / M²150
g/m²

• tienenie 85%

Č.p.	špecifikácia	
45460	1 x 10 m	1
45461	1,5 x 10 m	1
45463	1,8 x 10 m	1
45462	2 x 10 m	1

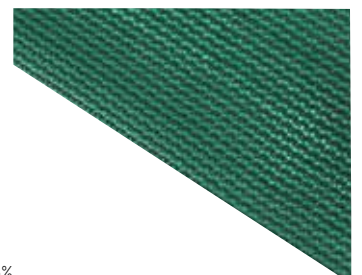
TIENIACA TKANINA HDPE 220 G / M²220
g/m²

• tienenie 95%

Č.p.	špecifikácia	
45465	1 x 10 m	1
45466	1,5 x 10 m	1
45467	2 x 10 m	1

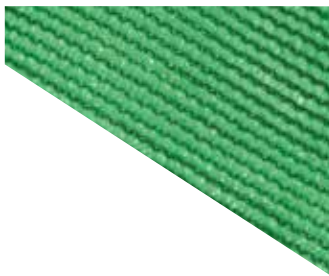
TIENIACA TKANINA HDPE 80 G / M²80
g/m²

Č.p.	špecifikácia	
45450	1 x 10 m	1
45451	1,5 x 10 m	1
45453	1,8 x 10 m	1
45452	2 x 10 m	1

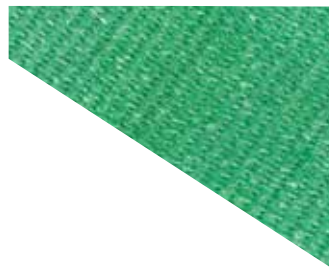
TIENIACA TKANINA HDPE 150 G / M²150
g/m²

• tienenie 85%

Č.p.	špecifikácia	
45480	1,5 x 50 m	1

TIENIACA TKANINA HDPE 220 G / M²220
g/m²

• tienenie 95%

Č.p.	špecifikácia	
45485	1,5 x 50 m	1

BAMBUS ŠTIEPANÝ



Č.p.	špecifikácia	
45410	1 x 5 m	1
45415	1,5 x 5 m	1
45420	2 x 5 m	1

ROHOŽ RÁKOSOVÁ



Č.p.	špecifikácia	
45425	1 x 5 m	5
45426	1,5 x 5 m	5
45427	2 x 5 m	5

SPONA TIENIAČEJ TKANINY

20x



Č.p.	špecifikácia	
45470		1



GRILOVANIE

SADA NÁRADIA

INOX

18x



Č.p. špecifikácia

43077



6

SADA GRILOVACIEHO NÁRADIA

INOX

3x



GRILOVACIE KLIŠTE

INOX



GRILOVACIA TÁCKA

4x



16



25

Č.p. špecifikácia
43071 380 mm

Č.p. špecifikácia
43072 360 mm

Č.p. špecifikácia
43050 300 x 200 mm

50

GRILOVACÍ ROŠT

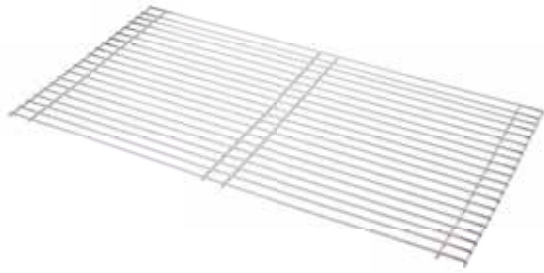

Č.p.	špecifikácia	
43058	58 x 30 mm	20
43060	60 x 40 mm	20
43068	68 x 40 mm	16

OPEKACIA MREŽKA



Č.p.	špecifikácia	
43084	330 x 290 mm	50

OPEKAČ RÝB

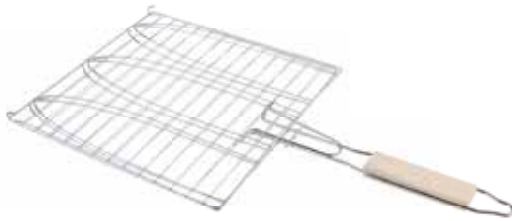

Č.p.	špecifikácia	
43082	280 x 276 mm	50

OPEKAČ RÝB



Č.p.	špecifikácia	
43083	360 x 130 mm	12

ŠAŠLÍKOVÉ IHlice

4x

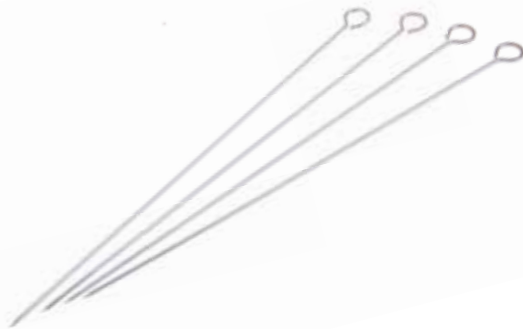

Č.p.	špecifikácia	
43086	Ø 3 x 380 mm	80

GRILOVACIA VIDLICA



Č.p.	špecifikácia	
43097	100 cm	100

· grilovacia vidlica s hygienickým atestom

GRILOVACÍ MOTOR 230V



Č.p. špecifikácia
43090



24

GRILOVACÍ MOTORČEK BATÉRIOVÝ



· batéria typ D

Č.p. špecifikácia
43089



48

KEFA NA ČISTENIE 2 V 1



Č.p. špecifikácia
43098 30 cm



10

KEFA 3 V 1



Č.p. špecifikácia
43099



40

MECHANICKÉ DÚCHADLO



Č.p. špecifikácia
43087



1



360

ZÁMKY VISIACE A ZÁMKY NA BICYKLE



364

POKLADNE A POŠTOVÉ SCHRÁNKY



366

UPÍNACIE POPRUHY



369

POVRAZY, MOTÚZY A VIAZACIE PÁSKY



371

TAVNÉ PIŠTOLE



373

DRŽIAKY A NOSIČE



375

ČISTIČE ODPADU



377

DOMÁCE POTREBY



378

SVETLÁ



381

PAPIEROVÉ PREZENTAČNÉ STOJANY



382

REGÁLOVÝ SYSTÉM SU-5



386

MURÁRSKE NÁRADIE KUBALA

ŽELEZIARSKY TOVAR

358 - 391



ZÁMKY



TREZOR S ELEKTRONICKÝM ZÁMKOM

FESTA®

NEW



4x AA

- typ zámku: elektronický, mechanický
- bezpečnostný kľúč
- rozmery 350x250x250mm
- hmotnosť 10kg



Č.p. špecifikácia

23270

1

VLOŽKA ZÁMKU MOSADZNÁ

FESTA®

VLOŽKA ZÁMKU POMOSADZENÁ



3x



3x

Č.p. špecifikácia

23001 65 mm · 175 g



12

Č.p. špecifikácia

23000 65 mm · 75 g



12

ZÁMOK VISIACI



Č.p.	špecifikácia		Č.p.	špecifikácia	
23261	25 mm	12	23264	45 mm	12
23262	32 mm	12	23265	52 mm	12
23263	38 mm	12	23266	63 mm	12

ZÁMOK VISIACI PREDĹŽENÝ



Č.p.	špecifikácia		Č.p.	špecifikácia	
23211	25 mm	12	23214	45 mm	12
23212	32 mm	12	23215	52 mm	6
23213	38 mm	12			

ZÁMOK VISIACI MOSADZNÝ POPLASTOVANÝ



Č.p.	špecifikácia	
23310	30 mm	10
23311	40 mm	10
23312	50 mm	6

ZÁMOK MOSADZNÝ ZOSILNENÝ



Č.p.	špecifikácia		Č.p.	špecifikácia	
23125	25 mm	12	23140	40 mm	12
23130	30 mm	12	23150	50 mm	12
23135	35 mm	12	23160	60 mm	12

ZÁMOK VISIACI



Č.p.	špecifikácia	
23273	50 mm	10
23274	60 mm	10
23275	70 mm	10

ZÁMOK VISIACI





Č.p.	špecifikácia		Č.p.	špecifikácia	
23220	25 mm	12	23240	40 mm	12
23225	30 mm	12	23250	50 mm	12
23232	32 mm	12	23260	60 mm	12

ZÁMOK POMOSADZENÝ

3x



Č.p.	špecifikácia		Č.p.	špecifikácia	
23020	20 mm	12	23040	40 mm	12
23025	25 mm	12	23050	50 mm	12
23030	30 mm	12	23060	60 mm	12
23035	35 mm	12			

ZÁMOK POMOSADZENÝ PREDLŽENÝ

3x



Č.p.	špecifikácia	
23070	40 mm	12

ZÁMOK VISAČI

3x



Č.p.	špecifikácia	
23010	50 mm	6

ZÁMOK VISAČI

2x



Č.p.	špecifikácia	
23005	40 mm	12
23006	50 mm	12

ZÁMOK NA BICYKEL S ČÍSELNÝM KÓDOM

FESTA®

ZÁMOK NA BICYKEL S ČÍSELNÝM KÓDOM

FESTA®



Č.p.	špecifikácia	
23288	120 cm x Ø 10 mm	1



Č.p.	špecifikácia	
23287	65 cm x Ø 10 mm	1

ZÁMOK NA BICYKEL S ÚCHYTOM

FESTA

ZÁMOK NA BICYKEL S ÚCHYTOM

2x



2x



Č.p.	špecifikácia	
23290	120 cm x Ø 8 mm	20
23291	150 cm x Ø 8 mm	20
23292	180 cm x Ø 8 mm	20

Č.p.	špecifikácia	
23296	150 cm x Ø 8 mm	25
23297	180 cm x Ø 8 mm	25

ZÁMOK NA BICYKEL

2x



Č.p.	špecifikácia	
23282	55 cm x Ø 8 mm	50
23284	65 cm x Ø 8 mm	50

ZÁVORA UZAMYKATEĽNÁ



3x



Č.p.	
51500	1

ZÁMOK VISACÍ S ČÍSELNÝM KÓDOM

VISAČKY KE KLÚČOM

FESTA

VISAČKY KE KLÚČOM

100x

100x



· zosilnený krúžok

Č.p.	špecifikácia	
23281		20

Č.p.	špecifikácia	
23391		50

Č.p.	špecifikácia	
23390		1

PETLICA

ZÁSTRČ



Č.p.	špecifikácia	
51514	100 mm	25
51515	120 mm	25
51516	140 mm	25
51517	160 mm	25

Č.p.	špecifikácia	
51510	100 mm	12
51511	120 mm	12
51512	140 mm	12
51513	160 mm	12

POKLADNE A POŠTOVÉ
SCHRÁNKY

SCHRÁNKA NA KLÚČE

2x 

Č.p.	špecifikácia	
70140	250 x 180 x 80 mm - pre 48 kľúčov	12
70141	300 x 230 x 90 mm - pre 90 kľúčov	8

POKLADŇA

2x 

Č.p.	šírka	hlbka	výška	
70120	125 mm	95 mm	60 mm	1

POKLADŇA

2x 

Č.p.	šírka	hlbka	výška	
70121	152 mm	118 mm	80 mm	30

POKLADŇA

2x 

Č.p.	šírka	hlbka	výška	
70122	200 mm	160 mm	90 mm	20

POKLADŇA

2x 

Č.p.	šírka	hlbka	výška	
70123	250 mm	180 mm	90 mm	16

POKLADŇA

2x 

Č.p.	šírka	hlbka	výška	
70124	300 mm	240 mm	90 mm	10

POKLADŇA

2x 

Č.p.	šírka	hlbka	výška	
70125	370 mm	280 mm	90 mm	7

SCHRÁNKA POŠTOVÁ PLASTOVÁ

2x 

Č.p.	farba	šírka	hlbka	výška	
70113	biela	240 mm	105 mm	345 mm	6

SCHRÁNKA POŠTOVÁ PLASTOVÁ

2x 

Č.p.	farba	šírka	hlbka	výška	
70114	hnedá	240 mm	105 mm	345 mm	6

SCHRÁNKA POŠTOVÁ



Č.p.	farba	šírka	hlbka	výška	
70101	biela	290 mm	360 mm	105 mm	5
70100	hnedá	290 mm	360 mm	105 mm	5

SCHRÁNKA POŠTOVÁ



Č.p.	farba	šírka	hlbka	výška	
70102	biela	310 mm	260 mm	90 mm	10
70103	hnedá	310 mm	260 mm	90 mm	6

SCHRÁNKA POŠTOVÁ



Č.p.	farba	šírka	výška	hlbka	
70104	biela	310 mm	360 mm	90 mm	6
70105	hnedá	310 mm	360 mm	90 mm	6

SCHRÁNKA POŠTOVÁ



Č.p.	farba	šírka	hlbka	výška	
70108	biela	370 mm	134 mm	364 mm	5

SCHRÁNKA POŠTOVÁ



Č.p.	materiál	šírka	hlbka	výška	
70107	nerez	360 mm	100 mm	520 mm	6

SCHRÁNKA POŠTOVÁ



Č.p.	materiál	šírka	hlbka	výška	
70106	nerez	360 mm	100 mm	360 mm	5

SCHRÁNKA POŠTOVÁ



Č.p.	materiál	šírka	hlbka	výška	
70109	nerez	310 mm	90 mm	260 mm	6

SCHRÁNKA POŠTOVÁ



Č.p.	materiál	šírka	hlbka	výška	
70110	nerez	310 mm	90 mm	360 mm	6



UPÍNACIE POPRUHY

POPRUHY UPÍNACIE SAMONAVÍJACIE

FESTA



2x



Č.p.	šírka	dĺžka	nosnosť	ks	
51070	18 mm	2 m	100 kg	2	8

POPRUH UPÍNACÍ SAMONAVÍJACÍ

FESTA



Č.p.	šírka	dĺžka	nosnosť	ks	
51071	25 mm	3,5 m	300 kg	1	12

POPRUH UPÍNACÍ SAMONAVÍJACÍ

FESTA



Č.p.	šírka	dĺžka	nosnosť	ks	
51072	35 mm	4 m	500 kg	1	6

POPRUHY UPÍNACIE

FESTA



Č.p.	šírka	dĺžka	nosnosť	ks	
51040	25 mm	6 m	1000 kg	1	1
51041	35 mm	8 m	2000 kg	1	1
51042	35 mm	8 m	3000 kg	1	1
51043	50 mm	10 m	5000 kg	1	1

POPRUHY UPÍNACIE

FESTA



2x



Č.p.	šírka	dĺžka	nosnosť	ks	
51060	25 mm	5 m	750 kg	2	5

POPRUH UPÍNACÍ

FESTA



Č.p.	šírka	dĺžka	nosnosť	ks	
51065	50 mm	10 m	960 kg	1	6

POPRUH UPÍNACÍ

FESTA



Č.p.	šírka	dĺžka	nosnosť	ks	
51026	75 mm	5 m	3000 kg	1	4

POPRUH UPÍNACÍ



Č.p.	šírka	dĺžka	nosnosť	ks	
51017	50 mm	6 m	480 kg	2	5
51018	50 mm	6 m	480 kg	1	10

PÁS UPÍNACÍ



Č.p.	šírka	dĺžka	špecifikácia	
51022	25 mm	5 m	s hákmi	40
51023	50 mm	5 m	s hákmi	12

PÁS UPÍNACÍ



PE



• mäččená EVA podložka

Č.p.	šírka	dĺžka	ks	
51046	38 mm	4 m	1	30

PÁS UPÍNACÍ



Č.p.	šírka	dĺžka	špecifikácia	
51030	50 mm	6 m	s hákmi	20
51034	50 mm	8 m	s hákmi	10

PÁS UPÍNACÍ

2x



Č.p.	šírka	dĺžka	ks	
51020	25 mm	2,5 m	2	100

PÁS UPÍNACÍ

PE



Č.p.	šírka	dĺžka	ks	
51045	25 mm	4 m	1	50

GUMA UPÍNACIA NASTAVITEĽNÁ

2x



Č.p.	dĺžka	Ø	ks	
51013	1,2 m	8 mm	2	30

GUMA UPÍNACIA

2x



Č.p.	dĺžka	ks	
51008	1 m	2	25

GUMA UPÍNACIA S KARABÍNAMI



Č.p.	dĺžka	ø	ks	
51009	1 m	10 mm	1	50

SADA UPÍNACÍCH POPRUHOV

8x

- 2 x 0,4 m
- 2 x 0,6 m
- 1 x 0,8 m
- 1 x 1,0 m



Č.p.	dĺžka	ø	ks	
51011	1 m	8 mm	8	10

GUMY UPÍNACIE

2x



Č.p.	dĺžka	ø	ks	
51001	80 cm	10 mm	2	50
51002	100 cm	10 mm	2	50
51003	150 cm	10 mm	2	50
51004	200 cm	10 mm	2	50

GUMY UPÍNACIE S HÁKMI

2x



Č.p.	dĺžka	ø	ks	
51007	1 m	8 mm	2	25

GUMY UPÍNACIE - PAVÚK



Č.p.	dĺžka	ø	špecifikácia	
51010	80 cm	8 mm	8 ramen	50

PRUŽNÁ UPEVŇOVACIA SIEŤ S HÁKMI



Č.p.	dĺžka	šírka	
51015	80 cm	120 cm	20

POPRUH ELASTICKÝ



Č.p.	dĺžka	ø	
51036	20 m	8 mm	10
51037	20 m	10 mm	6

HÁČIKY NA UPÍNACIE GUMY

20x



Č.p.	dĺžka	
51038	8 mm	30

KARABÍNA

ALU



MOQ
2

Č.p.	Ø	dĺžka		Č.p.	Ø	dĺžka	
51186	4 mm	40 mm	2	51202	7 mm	70 mm	2
51187	5 mm	50 mm	2	51201	8 mm	80 mm	2
51200	6 mm	60 mm	2	51203	10 mm	100 mm	2

POVRÁZOK SILÓNOVÝ



Č.p.	dĺžka	Ø	
51055	80 m	1,5 mm	50
51056	50 m	2 mm	50
51057	20 m	4 mm	50

MOTOUZ POLYPROPYLEN



Č.p.	špecifikácia	
50905	80 g	80
50906	100 g	100
50907	200 g	50

ŠPAGÁT JUTA



Č.p.	špecifikácia	
50900	80 g (61 m)	1
50901	100 g (76 m)	1
50902	200 g (153 m)	1

LANO PRIEMYSELNÉ



Č.p.	dĺžka	Ø	
50915	5 m	8 mm	1
50916	25 m	8 mm	1
50917	25 m	10 mm	1
50918	25 m	12 mm	1
50919	25 m	14 mm	1

LANO SILÓNOVÉ



Č.p.	dĺžka	Ø	
51050	50 m	8 mm	10
51051	50 m	10 mm	4

ŠPAGÁT POLYPROPYLÉN



Č.p.	špecifikácia	
50909	500 g (250 m)	1
50910	1000 g (500 m)	1
50911	5000 g (2500 m)	1

ŠNÚRA VOSKOVANÁ



Č.p.	dĺžka	Ø	
50920	50 m	1 mm	80

PÁSKY VIAZACIE S ÚCHYTM

10x



Ø 15 - 32 mm



Č.p.	dĺžka	šírka width
23865	160 mm	7,5 mm

1

PÁSKY VIAZACIE ČIERNE

50x



• EN 50146
• nylon

Č.p.	dĺžka	šírka
23810	120 mm	2,5 mm
23814	200 mm	3,6 mm
23816	250 mm	3,6 mm
23818	250 mm	4,8 mm
23820	300 mm	4,8 mm
23824	400 mm	4,8 mm
23826	500 mm	4,8 mm
23828	400 mm	7,6 mm
23830	500 mm	7,6 mm

1

VIAZACIA PÁSKA, SUCHÝ ZIPS



Č.p.	špecifikácia
45471	12 mm x 5 m

1

PÁSKY VIAZACIE FAREBNÉ

100x



• EN 50146
• nylon

Č.p.	dĺžka	šírka
23880	100 mm	2,5 mm
23882	150 mm	2,5 mm
23884	200 mm	3,6 mm



1

1

1

PÁSKY VIAZACIE BIELE

50x



• EN 50146
• nylon

Č.p.	dĺžka	šírka
23850	120 mm	2,5 mm
23854	200 mm	3,6 mm
23856	250 mm	3,6 mm
23858	250 mm	4,8 mm
23860	300 mm	4,8 mm
23864	400 mm	4,8 mm
23866	500 mm	4,8 mm
23868	400 mm	7,6 mm
23870	500 mm	7,6 mm



1

1

1

1

1

1

1

1

1

PÁSKA NA SUCHÝ ZIPS 3 KS

FESTA®

3x



Č.p.	šírka	dĺžka
37295	20 mm	150 mm
37296	20 mm	200 mm
37297	20 mm	250 mm



1

1

1

PIŠTOL' TAVNÁ - BEZDRÔTOVÁ

FESTA



Č.p. špecifikácia

89975 80 W | 230 V Ø tavné tyčinky 11,2 mm



20

PIŠTOL' TAVNÁ



Č.p. špecifikácia

89973 60 W | 230 V Ø tavné tyčinky 11,2 mm



20

PIŠTOL' TAVNÁ



Č.p. špecifikácia

89970 15 W | 230 V Ø tavné tyčinky 7,2 mm



20

TYČINKY DO TAVNEJ PIŠTOLE - ČÍRE



Č.p. Ø tyčinky dĺžka počet ks v balení

89985 11,2 mm 200 mm 10 50
89987 11,2 mm 200 mm 1 kg 25



50

TYČINKY DO TAVNEJ PIŠTOLE - ČÍRE



Č.p. Ø tyčinky dĺžka počet ks v balení

89980 7,2 mm 100 mm 12 100
89988 7,2 mm 100 mm 1 kg 25



100

TYČINKY DO TAVNEJ PIŠTOLE - FAREBNÉ



Č.p. Ø tyčinky dĺžka počet ks v balení

89990 11,2 mm 200 mm 10 50



50

TYČINKY DO TAVNEJ PIŠTOLE - FAREBNÉ



Č.p. Ø tyčinky dĺžka počet ks v balení

89989 7,2 mm 100 mm 12 100



100

PIŠTOĽ HORKOVZDUŠNÁ S REGULACÍU TEPLoty



FESTA



napätie / frekvencia	230V / 50Hz
príkion	2000W
poloha spínača	0 - I (350°C) - II (600°C)
príslušenstvo	nerezové nadstavce - 4 ks

Č.p.	špecifikácia
35320	2000 W



1

PIŠTOĽ TEPLOVZDUŠNÁ S REGULACIou TEPLoty A PRÚDU VZDUCHU



FESTA

- digitálny display



napätie / frekvencia	230V / 50Hz
príkion	2000W
poloha spínača	0 - I (50°C) - II (50 - 600°C)
prúd vzduchu	250 - 500 l/min.
príslušenstvo	nerezové nadstavce - 4 ks

Č.p.	špecifikácia
35322	2000 W



1

KÁBEL PREDLŽOVACÍ S NAVIJAKOM



- Predlžovací prívod s navijakom 25 m - IP20
- H05VV - F 3G 1,5mm², - Vybavený tepelnou poistkou |
- Výkon v navinutom stave: 1000 W max.
- Výkon v rozvinutom stave: 3000 W max.
- 4 uzemnené zásuvky s detskou poistkou



Č.p.	špecifikácia		
37760	4 zásuvky	dĺžka 25 m, IP 20, 1,5 mm ²	1
37761	4 zásuvky	dĺžka 50 m, IP 20, 1,5 mm ²	1

KÁBEL PREDLŽOVACÍ



Č.p.	špecifikácia		
37730	max. 3680 W	dĺžka 10 m, 1,5 mm ²	8
37731	max. 3680 W	dĺžka 20 m, 1,5 mm ²	4

SKLENÁRSKY DRŽIAK



SKLENÁRSKY DRŽIAK

ALU



poloha max. nosnosť
 horizontálna poloha 50 kg
 vertikálna poloha 50 kg



Č.p. špecifikácia
 36314 jednoduchý

20

Č.p. špecifikácia
 36305 jednoduchý

60

SKLENÁRSKY DRŽIAK



SKLENÁRSKY DRŽIAK

ALU



poloha max. nosnosť
 horizontálna poloha 80 kg
 vertikálna poloha 100 kg



Č.p. špecifikácia
 36313 dvojitý

20

Č.p. špecifikácia
 36306 dvojitý

20

SKLENÁRSKY DRŽIAK



SKLENÁRSKY DRŽIAK

NEW

ALU



NEW



poloha max. nosnosť
 horizontálna poloha 120 kg
 vertikálna poloha 150 kg

poloha max. nosnosť
 horizontálna poloha 80 kg
 vertikálna poloha 100 kg



Č.p. špecifikácia
 36318 trojitý

10

Č.p. špecifikácia
 36319 trojitý

10

MINCIAR ANALÓGOVÝ



Č.p. maximálna nosnosť
24260 50 kg



MINCIAR



Č.p.	maximálna nosnosť	
24212	12,5 kg	48
24225	25 kg	6
24250	50 kg	6
24255	100 kg	6
24258	150 kg	6

PINZETA S LED SVETLOM

INOX
3x LR41



Č.p. špecifikácia
50005 95 mm



SADA PINZIET NEREZ

INOX
2x



Č.p. špecifikácia
50004



PASCA NA MYŠI

2x



Č.p. špecifikácia
70221 90 x 45 mm drevená



PASCA NA MYŠI

2x



Č.p. špecifikácia
70220 97 x 47 mm plastová



ČISTIACI MOP



Č.p.
52110 30 cm



NÁHRADNÝ MOP

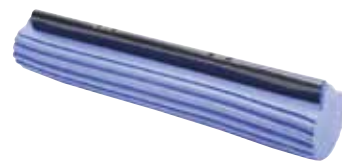

Č.p.
52111 30 cm



ČISTIČ ODPADU



· možnosť použitia s vrtačkou

Č.p.	dĺžka	Ø
50014	6 m	6 mm



ČISTIČ ODPADU



Č.p.	dĺžka	Ø
50009	3 m	5 mm



ČISTIČ ODPADU



Č.p.	dĺžka	Ø
50010	3 m	20
50011	5 m	10
50012	10 m	6
50013	15 m	4



PUMPA NA ČISTENIE ODPADU



Č.p.	dĺžka	Ø
50015	385 mm	65 mm



ELEKTRIKÁRSKA PREŤAHOVACIA PRUŽINA



Č.p.	dĺžka	Ø
51181	8 m	5 mm
51182	10 m	5 mm



ZBERAČ ODPADKOV



ZBERAČ ODPADKOV



· otočný o 90°

Č.p.	dĺžka
61235	81 cm

12
12

· max. 4 kg

Č.p.	špecifikácia
61236	



12
12

TELESKOPIKÁ TYČ

ALU



Č.p.	dĺžka	ALU	12
52010	120 cm	ALU	50
52012	240 cm	ALU	25



TELESKOPIKÁ TYČ



Č.p.	dĺžka	ocel	10
52020	300 cm	ocel	10



TELESKOPIKÁ TYČ



Č.p.	dĺžka	fiberglass	6
52030	240 cm	fiberglass	6



OLEJNIČKA



Č.p.	špecifikácia	
50020	300 ml	10

MAZNICA

- priame plnenie
- plnenie kartušou
- plnenie čerpadlom

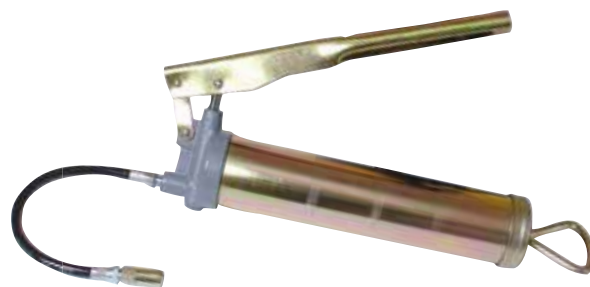

Č.p.	špecifikácia	
50022	400 ml	20

BARELOVÁ PUMPA



Č.p.	špecifikácia	
50017		10

OLEJNIČKA



Č.p.	špecifikácia	
50019	90 ml	1

POVOĽOVAČ FILTROV

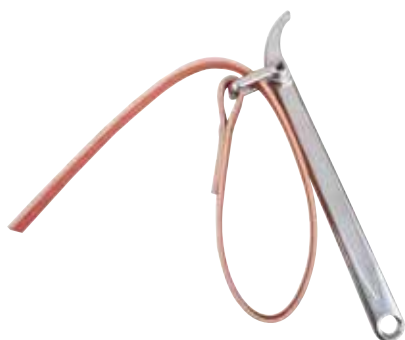

Č.p.	špecifikácia	
50021	60 x 140 mm	6

LIEVIK



Č.p.	špecifikácia	
50025	60 x 140 mm	50

HADICA PREČERPÁVACIA SO SAMONASÁVACÍM VENTILOM



Č.p.	dĺžka	ø	
50026	180 cm	15 mm	24

SVIEDIDLÁ



LED SVIETIDLO

- LED light
-
- 3x AAA

FESTA

magnety na pripavenie, napr: na kovové zárubne ai.



MOQ
12

Č.p.	špecifikácia
37645	200 mm 3 x AAA



LED ČELOVKA

- LED light
- 3x AAA
- 120 lumen

FESTA



váha	42 g
zdroj svetla	1 x 1 W white LED + 2x red LED
batérie	3 x AAA
rozmery	40 x 59 x 32 mm
doba svietenia	45 h
tok svetla	120 lumen
dosvit	60 m (100% battery)
režimy svietenia	4

5 pozícií vyklopenie

Č.p.	špecifikácia
37641	2 druhy svetla, biele a červené



LED ČELOVKA

- LED light
- 3x AAA
- 120 lumen

FESTA



Č.p.	špecifikácia
37640	120 lumen + červené svetlo



LED SVIETIDLO

FESTA

LED light

3x AA



220 lumen

mäkčené poplastovanie



130 lumen

nastaviteľná rukoväť



úchytka s háčikmi



č.p.

37650



12

LED SVIETIDLO

FESTA

ALU

LED light

2x AA

80 lumen



č.p.

špecifikácia

37630

185 mm

2 x AA



20

LED SVIETIDLO

LED light



	č.p.	37621
výkon		0,6 W
farebná teplota		700k
batérie		2xD
váha		138g
dĺžka dosvitu		30 m
svietivosť		50 lm

č.p.

špecifikácia

37621

185 mm



6

KONZOLA BIELA

MOQ
2

Č.p.	špecifikácia	
81100	100 x 75 mm	24
81101	125 x 100 mm	24
81102	150 x 125 mm	24
81103	200 x 150 mm	24
81104	250 x 200 mm	24
81105	300 x 250 mm	24
81106	350 x 300 mm	24

KONZOLA HNEDÁ

MOQ
2

Č.p.	špecifikácia	
81113	200 x 150 mm	24
81114	250 x 200 mm	24
81115	300 x 250 mm	24

REGÁLOVÁ STOJKA JEDNODUCHÁ



REGÁLOVÝ HÁK JEDNODUCHÝ



Č.p.	špecifikácia	
81053	50 cm	10
81054	80 cm	10
81055	100 cm	10
81056	150 cm	10
81057	200 cm	10



Č.p.	špecifikácia	
81070	10 cm	10
81071	15 cm	10
81072	20 cm	10
81073	25 cm	10
81074	30 cm	10
81075	35 cm	10
81076	40 cm	10
81077	50 cm	10



PAPIEROVÝ PREZentačný STOJAN FESTA



Č.p. špecifikácia
81601 60 x 40 x 175 cm - SK



1

PAPIEROVÝ PREZentačný STOJAN FESTA POWER TOOLS



Č.p. špecifikácia
81603 60 x 40 x 175 cm



1

PAPIEROVÝ PREZentačný STOJAN NA NIVELAČNÉ SYSTÉMY



Č.p. špecifikácia
37169 60 x 40 x 175 cm - SK



1



STOJAN FESTA + PRÍSLUŠENSTVO



Č. p.	špecifikácia		
81011	stojan FESTA 220 x 100 cm	1	
81011A	stojan 81011 + samolepka AQUATIC	1	
81011F	stojan 81011 + samolepka FESTA CZ	1	
81011G	stojan 81011 + samolepka FESTA GB	1	
81011H	stojan 81011 + samolepka FESTA SK	1	
81011R	stojan 81011 + samolepka ROSA	1	
81012	polica FESTA 100 x 40 cm	8	
81013	háčik 10 cm	10	
81014	háčik 16 cm	10	
81015	háčik 20 cm	10	
81035	háčik s visačkou 20 cm	10	
81016	háčik 30 cm	10	
81036	háčik s visačkou 30 cm	10	
81022	kôš na hladítka - veľký, 50 cm	1	
81023	kôš na hladítka - malý, 40 cm	1	
81024	priečka ku košu - veľká, 50 cm	1	
81025	priečka ku košu - malá, 40 cm	1	



REGÁLOVÝ SYSTÉM SU - 5



RADI VÁM UROBÍME PONUKU NA POŽADOVANÚ REGÁLOVÚ ZOSTAVU

Č.p.	špecifikácia		Č.p.	špecifikácia		Č.p.	špecifikácia	
81200	Stojka 40/2400 mm kotvená	1	81293	Záves jednoduchý 100	1	81389	Zadný panel 200 / 1250mm plný	1
81201	Stojka 80/1108 mm	1	81294	Záves jednoduchý 200	1	81390	Zadný panel 400 / 1250mm plný	1
81202	Stojka 80/1208 mm	1	81295	Záves jednoduchý 300	1	81391	Zadný panel 200 / 1250mm dierovaný	1
81203	Stojka 80/1408 mm	1	81296	Jednoháčik s hrazdou 200	1	81393	Kryt gondoly 80 / 1250mm	1
81204	Stojka 80/1608 mm	1	81297	Jednoháčik s hrazdou 300	1	81392	Zadný panel 400 / 1250mm dierovaný	1
81205	Stojka 80/1808 mm	1	81298	Zámok vitríny	1	81394	Kryt gondoly 60 / 1250mm	1
81206	Stojka 80/2000 mm	1	81299	Delítka drôtené 360mm vysoké	1	81395	Nosník závesov 1250mm	1
81207	Stojka 80/2108 mm	1	81300	Delítka drôtené 460 mm vysoké	1	81396	Polica 200 / 1250mm	1
81208	Stojka 80/2208 mm	1	81301	Delítka drôtené 560 mm vysoké	1	81439	Nosník závesov 1000 mm	1
81209	Stojka 80/2308 mm	1	81302	Delítka drôtené 560 mm nízke	1	81344	Polica 300/1000 zosilnená	1
81210	Stojka 80/2408 mm	1	81303	Konzola 300 dvojité L	1	81345	Polica 400/1000 zosilnená	1
81211	Stojka 80/2600 mm	1	81304	Konzola 300 dvojité P	1	81346	Polica 500/1000 zosilnená	1
81212	Stojka 60/1000 mm	1	81305	Konzola 400 dvojité L	1	81397	Polica 300 / 1250mm	1
81213	Stojka 60/1208 mm	1	81306	Konzola 400 dvojité P	1	81400	Polica 300 / 1250mm, zosilnená	1
81214	Stojka 60/1408 mm	1	81307	Konzola 500 dvojité L	1	81401	Polica 400 / 1250mm, zosilnená	1
81215	Stojka 60/1608 mm	1	81308	Konzola 500 dvojité P	1	81402	Polica 500 / 1250mm, zosilnená	1
81216	Stojka 60/1808 mm	1	81309	Polica polkruh 300	1	81398	Polica 400 / 1250mm	1
81217	Stojka 60/2108 mm	1	81310	Polica polkruh 400	1	81399	Polica 500 / 1250mm	1
81218	Stojka 60/2208 mm	1	81311	Polica polkruh 500	1	81404	Čelná opora nízka 1250mm, plast biely	1
81225	Stojka 30/2108 mm predná	1	81312	Šokel polkruhu 500	1	81405	Cenovková lišta, 1250mm	1
81486	Stojka 60/2000 mm	1	81313	Celo sokla polkruhu 500	1	81406	hřebeň 1250mm	1
81219	Nástavec stojky 80x30/100mm	1	81314	Držiak cenovky pol. 300 polkruh	1	81407	Držiak cenovky, 1250mm	1
81220	Nástavec stojky 80x30/400 mm	1	81315	Držiak cenovky pol. 400 polkruh	1	81408	Čelo zastrešenia, 1250mm	1
81221	Nástavec stojky 80x30/600 mm	1	81316	Držiak cenovky pol. 500 polkruh	1	81409	Doska zastrešenia, 600x1250mm	1
81222	Nástavec stojky 60x30/400 mm	1	81317	Polica polkruh 600	1	81410	Zadný panel 100/625 plný	1
81223	Stojka rohová 90st. 2100mm	1	81318	Šokel polkruhu 600	1	81411	Zadný panel 200/625 plný	1
81224	Stojka rohová 90st. 2200mm	1	81319	Celo sokla polkruhu 600	1	81412	Zadný panel 400/625 plný	1
81226	podpera 80	1	81320	Cenovka P 7,5x5 cm	1	81413	Zadný panel 400/625 dierovaný	1
81227	podpera 60	1	81321	Cenovka P 2,6x3,2 cm	1	81414	Kryt gondol 80/650	1
81228	Spojka gondoly s regálom 80	1	81322	Cenovka P 5,0x4,0 cm	1	81415	Kryt gondol 60/650	1
81229	Kotvená lišta	1	81323	Polica dierovaná 500/1000	1	81416	Nosník závesov, modul 3	1
81230	Kotvený hák	1	81324	Spojnicia stojok 80, modul 1	1	81432	Nosník závesov, 1330mm	1
81231	kotvenie ľahké	1	81325	Zadný panel 10x100cm	1	81417	police 300/625	1
81232	kotvenie vrchné	1	81326	Zadný panel 20x100cm	1	81418	police 400/625	1
81233	Výplň 400	1	81327	Zadný panel 40x100cm	1	81419	police 500/625	1
81234	Výplň 500	1	81328	Zadný panel dier. 20x100 cm EUR	1	81421	Čelná opora nízka 625, plast biely	1
81235	Výplň 600	1	81329	Zadný panel dier. 40x100 cm EUR	1	81422	Cenovková lišta 625mm	1
81236	Výplň 700	1	81330	Kryt gondol 8x100cm	1	81423	hřebeň 625mm	1
81237	Výplň 800	1	81331	Kryt gondol 6x100cm	1	81424	Držiak cenovky, 625mm	1
81238	Konzola nízka 200	1	81332	Nosník závesov 100cm	1	81425	Zadný panel 100/1330 plný	1
81239	Konzola nízka 300	1	81333	Polica sklenená 985/300 vitrína	1	81457	Čelná opora nízka 200 plast	1
81240	Konzola nízka 400	1	81334	Polica sklenená 985/400 vitrína	1	81426	Zadný panel 200/1330 plný	1
81241	Konzola nízka 500	1	81335	Polica drevená 47/98,5	1	81427	Zadný panel 400/1330 plný	1
81242	Konzola vysoká 400	1	81336	Polica drôtená 1000/500	1	81428	Zadný panel 200/1330 dierovaný S	1
81243	Konzola vysoká 500	1	81337	Polica korytová 1000x500	1	81429	Zadný panel 400/1330 dierovaný S	1
81244	Konzola vysoká 600	1	81338	Polica 200/1000	1	81430	Kryt gondol 80/1330	1
81245	Konzola vysoká 700	1	81339	Polica 300/1000	1	81431	Kryt gondol 60/1330	1
81246	Konzola nízka 300 dvojité	1	81340	Polica 400/1000	1	81433	police 300/1330	1
81247	Konzola nízka 400 dvojité	1	81341	Polica 500/1000	1	81434	police 400/1330	1
81248	Konzola nízka 300 dvojité	1	81342	Polica 400/1000 RAL7015	1	81435	police 500/1330	1
81251	Konzola RR 80	1	81343	Polica 500/1000 RAL7015	1	81436	Cenovková lišta, 1330 mm	1
81249	Konzola vysoká dvojité 500	1	81347	Rám vysokej vitríny 1000/400	1	81437	Hřebeň 1330 mm	1
81250	Nosník vys. vitríny 400/2000	1	81348	Skló rámu vysokej vitríny 1000/400	1	81438	Držiak cenovky 1330 mm	1
81252	Delítka korytovej police	1	81349	Zásuvková vložka regálová	1	81440	Polica drôtená - kôš	1
81253	Delítka nízke 300	1	81350	Podhlad kovovej police 500/100	1	81441	Polica panel 100 kútový	1
81254	Delítka nízke 400	1	81352	Čelná opora vysoká 1000 mm, sklo	1	81442	Zadný panel 400 kútový	1
81255	Delítka nízke 500	1	81353	Čelná opora vysoká, plexi	1	81443	Čelo sokla kútové 500 / 1000mm	1
81256	Delítka nízke 300 sklo	1	81354	Čelná opora nízka 1000 mm, plast	1	81444	Čelo sokla kútové 600 mm	1
81257	Delítka nízke 400 sklo	1	81355	Cenovková lišta, 1000mm	1	81445	Zadný panel kútový 400mm dierovaný	1
81258	Delítka nízke 500 sklo	1	81356	Hřebeň zásuvky regálu	1	81447	Polica 300 kútová	1
81259	Delítka vysoké 300 sklo	1	81351	Hřebeň pre vysoké delítka, 1000	1	81448	Polica 400 kútová	1
81262	Delítka vysoké 300 plexi	1	81357	Hřebeň, 1000 mm	1	81449	Polica 500 kútová	1
81263	Delítka vysoké 400 plexi	1	81403	Hřebeň pre vysoké delítka, 1250 mm	1	81450	Polica 600 kútová	1
81264	Delítka vysoké 500 plexi	1	81420	Hřebeň pre vysoké delítka, 625 mm	1	81451	Držiak cenovky 300 kútový	1
81260	Delítka vysoké 400 sklo	1	81358	Dvojdrážka dvierok vitríny	1	81452	Držiak cenovky 400 kútový	1
81261	Delítka vysoké 500 sklo	1	81359	Držiak cenovky, 1000mm	1	81453	Držiak cenovky 500 kútový	1
81265	Bok vys. vitríny 400/2000	1	81360	Dvere vys. vitríny 1000/2000	1	81454	Lišta Cenovková 300 kútová	1
81266	Bočnica zastrešenie RR 80	1	81361	Čelo zastrešenia, 1000mm	1	81455	Lišta Cenovková 400 kútová	1
81267	Bočnica zásobníka 500mm	1	81362	Doska zastrešenia, 1000mm	1	81456	Lišta Cenovková 500 kútová	1
81268	Bočnica vitríny 500	1	81363	Dvierka zásobníka	1	81458	Polica drôtená kôš U 1000/400	1
81269	Nosník hornej vitríny 500	1	81364	Dvierka vitríny posuvné	1	81459	Polica drôtená kôš U 1000/500	1
81271	Bočnica police nízka 300 plast	1	81365	Zrkadlo vitríny	1	81460	Rohové čelo sokla 90st.	1
81272	Bočnica police nízka 400 plast	1	81366	Závesový rám, modul 1	1	81461	Panel zadný rohový 100, stojka 60	1
81273	Bočnica police nízka 500 plast	1	81367	Závesová tyč	1	81462	Panel zadný rohový 200, stojka 60	1
81274	Bočnica vysoká sklo 300/250	1	81370	Kôš drôtený šikmý	1	81463	Panel zadný rohový 400, stojka 80	1
81275	Poistka Bočnica	1	81371	Pult s plnou doskou 1000mm	1	81466	Panel zadný rohový 100, stojka 80	1
81276	Bočnica vysoká sklo 500/250	1	81372	Sokel pultu SU 5 1000mm	1	81467	Panel zadný rohový 400, stojka 60	1
81277	Bočnica police vysoká 400	1	81373	Pult presklený 1000mm	1	81468	Polica rohová 90st. 400mm	1
81278	Bočnica police vysoká 500	1	81374	Pult s nerez doskou 1000mm	1	81469	Polica rohová 90st. 500mm	1
81270	Nosník zastrešenie RR 80	1	81375	Pult s plnou doskou 600mm	1	81470	Držiak cenovky rohový 90st. 400mm	1
81279	Nosník zastrešenie	1	81376	Polica do pultu 600mm	1	81471	Držiak cenovky rohový 90st. 500mm	1
81280	Bočnica zastrešenie ľavá	1	81377	Pult presklený 600mm	1	81472	Cenovková lišta rohová 90st. 400mm	1
81281	Bočnica zastrešenie pravá	1	81378	Polica do pultu 1000mm	1	81473	Cenovková lišta rohová 90st. 500mm	1
81282	Závesové rameno	1	81379	Poliečka pultu dlhá	1			
81284	Rameno dvojité 400/10	1	81380	Segment pultu vysoký 90st.	1			
81285	Rameno dvojité 300/8	1	81381	Dvojdrážka pultu 1000mm, pár	1			
81286	Rameno jednoduché 350	1	81382	Dvierka posuvné, pult 1000mm, pár	1			
81287	Rameno jednoduché 500	1	81383	Zásuvka pod dosku	1			
81288	Rameno jednoduché 250	1	81384	Polica drôtená RDE 1000 / 360mm	1			
81289	Záves dvojité 100	1	81385	Polica drôtená RDE 1000 / 460mm	1			
81290	Záves dvojité 200	1	81386	Polica drôtená RDE 1000 / 560mm	1			
81291	Záves dvojité 300	1	81387	Cenovková lišta RDE 1000 mm	1			
81292	Záves 130 V	1	81388	Zadný panel 100 / 1250mm plný	1			

TRADE KONZOLA

· kompatibilné so stojanom FESTA

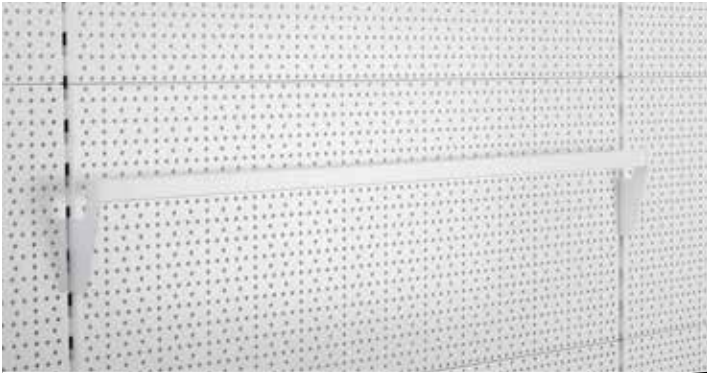

Č.p.	špecifikácia
81150	1000 × 50 × 135 mm



TRADE KONZOLA

· kompatibilné so stojanom FESTA

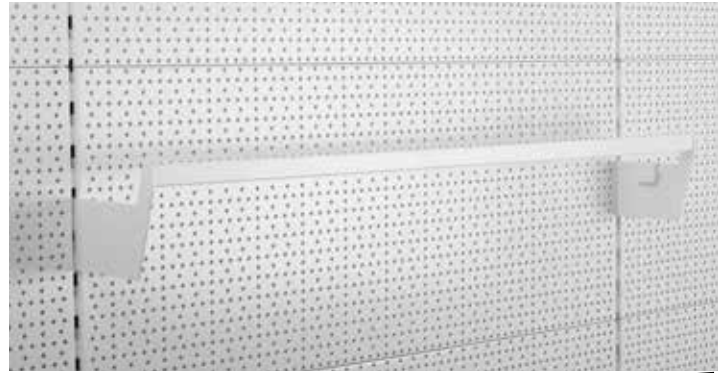

Č.p.	špecifikácia
81151	1000 × 150 × 135 mm



TRADE KONZOLA

· kompatibilné so stojanom FESTA

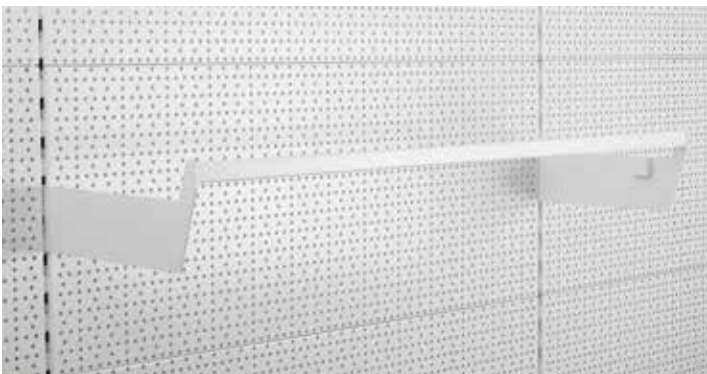

Č.p.	špecifikácia
81152	1000 × 350 × 135 mm

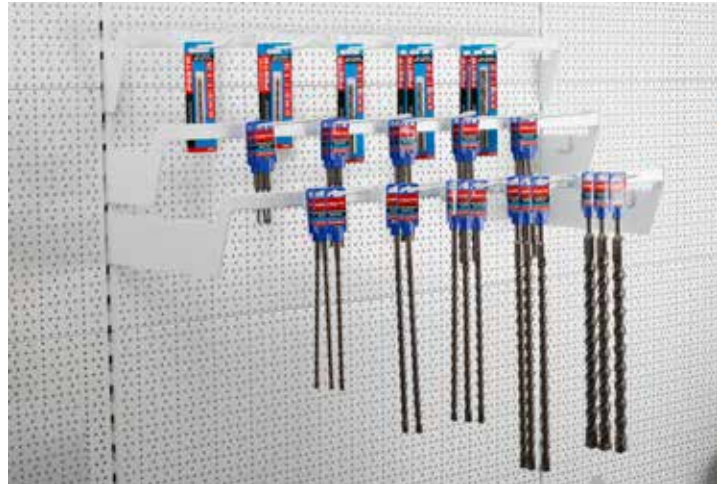

DRŽIAK CENOVKOVEJ LIŠTY

· kompatibilné so stojanom FESTA



Č.p.	špecifikácia
81155	1000 × 80 × 100 mm



RÁM PRE REZNÉ KOTUČE

· kompatibilné so stojanom FESTA

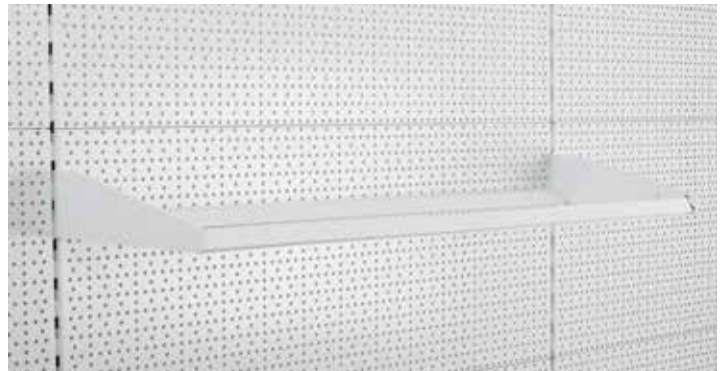

Č.p.	špecifikácia
81170	1000 × 450 × 85 mm



HÁK PRE REZNÉ KOTUČE

· kompatibilné so stojanom FESTA

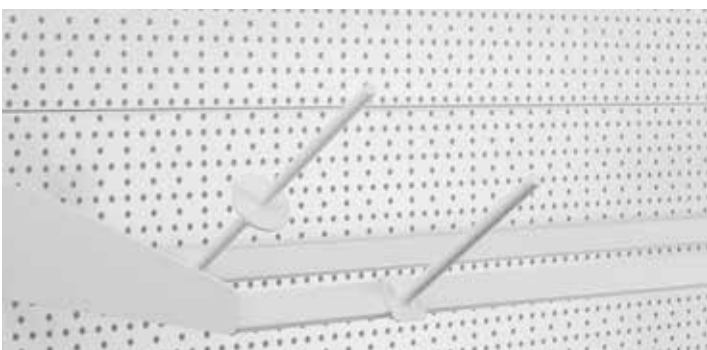

Č.p.	špecifikácia
81186	150 mm
81185	250 mm



HÁK PRE AKU NÁRADIE

· kompatibilné so stojanom FESTA



Č.p.	špecifikácia
81189	



DRŽIAK NA PÍLY

· kompatibilné so stojanom FESTA

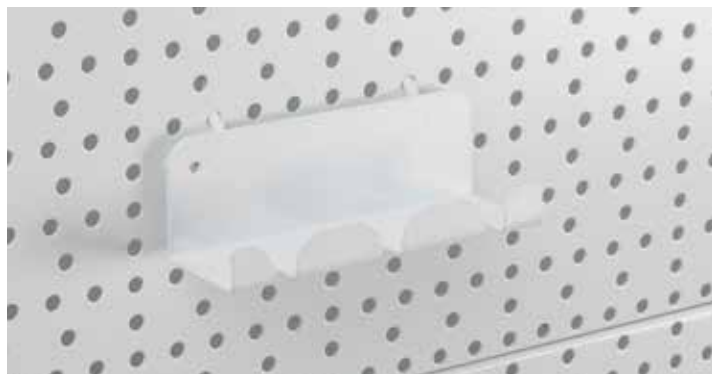

Č.p. špecifikácia

81190



1

POLICE PRE KOTUČE

· kompatibilné so stojanom FESTA



Č.p. špecifikácia

81191 220 x 220 x 200 mm



1

KOŠ ZÁVESNÝ

· kompatibilné so stojanom FESTA

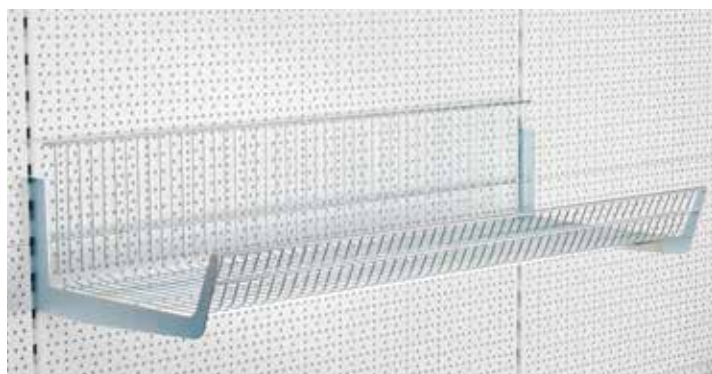

Č.p. špecifikácia

81160 1000 x 470 x 180 mm



1

HÁK DVOJITÝ NA HRAZDU

· kompatibilné so stojanom FESTA

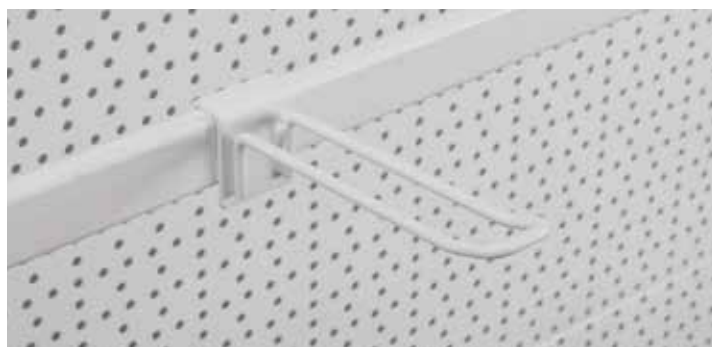

Č.p. špecifikácia

81175 120 mm



1

81178 180 mm

1



DELÍTKO

· kompatibilné so stojanom FESTA



Č.p. špecifikácia

81165 470 x 180 mm



1

HÁK JEDNODUCHÝ NA HRAZDU

· kompatibilné so stojanom FESTA



Č.p. špecifikácia

81180 120 mm



1

HLADÍTKO NEREZ

Kubala

INOX



Č.p.	špecifikácia		
33100	130 x 270 mm	hladké, 2 zaoblené rohy	1

HLADÍTKO NEREZ

Kubala

INOX



Č.p.	špecifikácia		
33102	130 x 270 mm	hladké, G-1 rúčka	1

HLADÍTKO NEREZ

Kubala

INOX



Č.p.	špecifikácia		
33105	130 x 350 mm	hladké, G-8 rúčka	1

HLADÍTKO NEREZ

Kubala

INOX



Č.p.	špecifikácia		
33107	110 x 270 mm	rohové	1

HLADÍTKO NEREZ

Kubala

INOX



Č.p.	špecifikácia		
33110	130 x 270 mm	hladké, G-11 rúčka	1

HLADÍTKO NEREZ

Kubala

INOX



Č.p.	špecifikácia		
33112	130 x 270 mm	zub 6 x 6, G-11 rúčka	1
33113	130 x 270 mm	zub 8 x 8, G-11 rúčka	1
33114	130 x 270 mm	zub 10 x 10, G-11 rúčka	1

HLADÍTKO NEREZ

Kubala

INOX



Č.p.	špecifikácia		
33120	130 x 480 mm	hladké, G-12 rúčka	1

HLADÍTKO NEREZ

Kubala

INOX



Č.p.	špecifikácia		
33123	130 x 480 mm	zub 8 x 8, G-12 rúčka	1
33124	130 x 480 mm	zub 10 x 10, G-12 rúčka	1

HLADÍTKO NEREZ OBLÉ ROHY



INOX



Č.p.	špecifikácia	
33127	130 x 480 mm 2 zaoblené rohy	10

HLADÍTKO NEREZ " BENÁTSKE "



INOX



Č.p.	špecifikácia	
33131	80 x 200 mm G-1 rúčka	10
33132	75 x 95 x 240 mm trapezové G-1 rúčka	10

HLADÍTKO NEREZ



INOX



Č.p.	špecifikácia	
33135	130 x 270 mm šikmé zuby 8 mm, G-1 rúčka	10

HLADÍTKO NEREZ



INOX



Č.p.	špecifikácia	
33137	130 x 270 mm zub polkruhový, G-1 rúčka	10

LYŽICA NEREZ VYMAZÁVACIA



INOX



Č.p.	špecifikácia	
33140	50 mm	20
33141	60 mm	20
33142	80 mm	20
33143	100 mm	20

HLADÍTKO PLASTOVÉ ABS



Č.p.	špecifikácia	
33150	130 x 240 mm	12

HLADÍTKO PLASTOVÉ

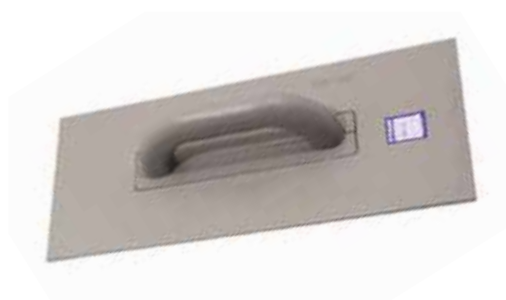

Č.p.	špecifikácia	
33151	180 x 400 mm	1
33152	130 x 600 mm	1

HLADÍTKO PLASTOVÉ



Č.p.	špecifikácia	
33154	130 x 270 mm G-17 rúčka	12

ŠKRABÁK PLECHOVÝ NA KAMENNÚ MINERÁLNŤ VLNŤ

Kubala

Zn

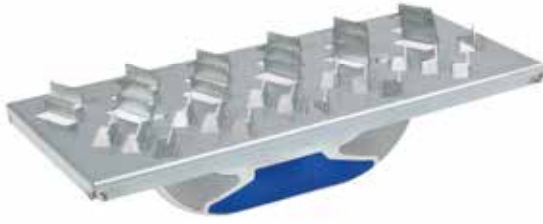
MOQ
2

Č.p.	špecifikácia	
32328	285 x 145 mm	10

HLADÍTKO NA BRŮSNU MRIEŽKU

Kubala



Č.p.	špecifikácia	
33160	105 x 210 mm s podkladovou gumou	20

HLADÍTKO BRŮSNE

Kubala

INOX

MOQ
2

Č.p.	špecifikácia	
33162	130 x 270 mm	20
33163	180 x 400 mm	10
33164	160 x 380 mm	10

HLADÍTKO BRŮSNE PLASTOVÉ

Kubala

MOQ
2

Č.p.	špecifikácia	
33165	165 x 365 mm	10

HLADÍTKO BRŮSNE

Kubala

INOX

MOQ
2

Č.p.	špecifikácia	
33166	130 x 600 mm	2

HLADÍTKO BRŮSNE

Kubala

MOQ
2

Č.p.	špecifikácia	
33167	130 x 270 mm G-17 rúčka	20
33168	160 x 380 mm G-17 rúčka	10
33170	180 x 400 mm G-17 rúčka	10

HLADÍTKO BRŮSNE S OTVORMI

Kubala

MOQ
2

Č.p.	špecifikácia	
33169	160 x 380 mm dierkované, G-16 rúčka	10

ŠKRABÁK PLASTOVÝ S KLINCAMI

Kubala

MOQ
2

Č.p.	
33173	2

STIERKA NEREZ



INOX



Č.p.	špecifikácia	
33200	40 mm	20
33201	60 mm	20
33202	80 mm	20
33203	100 mm	20

STIERKA NEREZ



INOX



Č.p.	špecifikácia	
33205	130 x 90 mm	20

STIERKA NEREZ



INOX



Č.p.	špecifikácia	
33206	130 x 37 mm	20

STIERKA NEREZ



INOX



Č.p.	špecifikácia	
33207	150 mm s bitom PH2	30

STIERKA NEREZ



INOX



Č.p.	špecifikácia	
33208	350 x 90 mm	10

STIERKA NEREZ



INOX



Č.p.	špecifikácia	
33209	335 x 37 mm	20

STIERKA NEREZ



INOX



Č.p.	špecifikácia	
33210	150 mm G-15 rúčka	10
33211	250 mm G-15 rúčka	10
33212	350 mm G-15 rúčka	10

STIERKA NEREZ FASÁDNÁ



INOX



Č.p.	špecifikácia	
33215	600 mm AL uchytenie, G-14 rúčka	10

STIERKA PLASTOVÁ



Č.p.	špecifikácia		
33220	145 mm s gumou		10

STIERKA PLASTOVÁ



Č.p.	špecifikácia		
33221	245 mm s gumou		10

HLADÍTKO PLASTOVÉ, GUMA POD UHLOM



Č.p.	špecifikácia		
33155	95 x 240 mm s podkladovou gumou		5

SÚPRAVA PRE OBKLADAČOV



Č.p.	špecifikácia		
33250			1

VEDRO OBDĹŽNIKOVÉ



Č.p.	špecifikácia		
33254	16 l mriežka, kolieska		1
33255	20 l mriežka, kolieska		1

SÚPRAVA PRE OBKLADAČOV MINI



Č.p.	špecifikácia		
33252			1

DIELY PRE VYMÝVACIE SADY



Č.p.	špecifikácia		
33257	trojité valčeky do vedra		1

DIELY PRE VYMÝVACIE SADY



Č.p.	špecifikácia		
33256	valčeky do vedra		1
33258	valčeky do vedra		1

DIŠŤANČNÉ SPONY SMART LEVEL



100x



· nivelačné klinky 37175, 33246



Č.p.	špecifikácia	
33247	1 mm	15
33248	2 mm	15
33249	3 mm	15

NIVELAČNÉ KLINKY



50x



Č.p.	špecifikácia	
33246	Smart Level	15

NABERAČKA PLASTOVÁ



MISKA NA SADRU GUMOVÁ



STIERKA GUMOVÁ



Č.p.	špecifikácia	
33270	175 mm	20

Č.p.	špecifikácia	
33275	0,5 l	20

Č.p.	špecifikácia	
33280	200 mm	10
37010	135 mm	20

NIVELAČNÝ VALČEK



ŠKRABÁK NA FARBY CIDLINKA



Č.p.	špecifikácia	
33289	85 x 230 mm	15

Č.p.	špecifikácia	
33285	60 mm	1
33286	náhradné ostrie 60 mm	1

VRTÁK DO PÓROBETÓNU



POKOSNICA PLASTOVÁ



Č.p.	špecifikácia	
33291	60 mm	1
33292	80 mm	1
33293	120 mm	1

Č.p.	špecifikácia	
33298	250 x 80 x 50 mm	1
33299	300 x 115 x 65 mm	1





AUTODOPLŇKY

392 - 403



HYDRAULICKÝ ZDVIHÁK, JEDNOPIESTOVÝ



- Nastaviteľný skrutku umožňuje jemné nastavenie výšky a maximálny zdvih
- Dvojitý bezpečnostný prepúšťací ventil
- Veľká vrúbkovaná dosadacia plocha pre bezpečné podopretie
- Široká základňa zaisťuje stabilitu a odolnosť
- Všetky silne namáhané body sú zosilnené pre zvýšenie odolnosti a životnosti



Č.p.	špecifikácia	nosnosť	min výška	zdvih	jemné nastavenie výšky	špecifikácia základne	váha	
26800	Hydraulický zdvihák	2 000 kg	181 mm	116 mm	48 mm	88 x 92 mm	2,6 kg	1
26801	Hydraulický zdvihák	3 000 kg	194 mm	118 mm	60 mm	92 x 100 mm	3,3 kg	1
26802	Hydraulický zdvihák	5 000 kg	216 mm	127 mm	70 mm	96 x 112 mm	4,5 kg	1
26803	Hydraulický zdvihák	8 000 kg	230 mm	147 mm	80 mm	103 x 118 mm	5,7 kg	1
26804	Hydraulický zdvihák	10 000 kg	230 mm	150 mm	80 mm	110 x 123 mm	6,8 kg	1
26805	Hydraulický zdvihák	12 000 kg	230 mm	155 mm	80 mm	116 x 134 mm	7,3 kg	1
26806	Hydraulický zdvihák	15 000 kg	230 mm	150 mm	80 mm	133 x 136 mm	8,4 kg	1
26807	Hydraulický zdvihák	20 000 kg	242 mm	150 mm	60 mm	144 x 152 mm	11 kg	1

HYDRAULICKÝ ZDVIHÁK, DVOJPIESTOVÝ



- Nastaviteľný skrutku umožňuje jemné nastavenie výšky a maximálny zdvih.
- Dvojitý bezpečnostný prepúšťací ventil.
- Veľká vrúbkovaná dosadacia plocha pre bezpečné podopretie.
- Široká základňa zaisťuje stabilitu a odolnosť.
- Všetky silne namáhané body sú zosilnené pre zvýšenie odolnosti a životnosti.



Č.p.	špecifikácia	nosnosť	min výška	zdvih	jemné nastavenie výšky	váha	
26815	Hydraulický zdvihák teleskopický	2 000 kg	150 mm	160 mm	60 mm	4,7 kg	1
26816	Hydraulický zdvihák teleskopický	4 000 kg	160 mm	170 mm	60 mm	6,4 kg	1
26817	Hydraulický zdvihák teleskopický	6 000 kg	215 mm	270 mm	-	8,9 kg	1
26819	Hydraulický zdvihák teleskopický	10 000 kg	228 mm	284 mm	89 mm	10,2 kg	1

NOŽNICOVÝ ZDVIHÁK



Č.p.	špecifikácia	nosnosť	min výška	max výška	váha	
26844	nožnicový zdvihák	1 000 kg	88 mm	380 mm	2,5 kg	1
26845	nožnicový zdvihák	2 000 kg	120 mm	395 mm	3,5 kg	1

HYDRAULICKÝ POJAZDNÝ ZDVIHÁK



Č.p.	špecifikácia	nosnosť	min výška	max výška	váha	
26820	Hydraul. zdvihák pojazdný, prenosný	2 000 kg	130 mm	345 mm	9,6 kg	1
26826	Hydraul. zdvihák pojazdný, nízky profil, 360 ° otoč. madlo	2 000 kg	89 mm	359 mm	14,2 kg	1
26824	Hydraul. zdvihák pojazdný, dielenský, nožný pedál	3 000 kg	145 mm	500 mm	37,2 kg	1
26825	Hydraul. zdvihák pojazdný, dielenský, nízky profil, profi	2 500 kg	85 mm	455 mm	34,8 kg	1

HYDRAULICKÝ POJAZDNÝ ZDVIHÁK, HLINÍKOVÝ, NÍZKOPROFILOVÝ



Č.p.	špecifikácia	nosnosť	min výška	max výška	
26840		2 000 kg	100 mm	465 mm	1

HYDRAULICKÝ POJAZDNÝ ZDVIHÁK + PODPERY



· ovládacia tyč otočná o 360°



Č.p.	špecifikácia	nosnosť	min výška	max výška	váha	
26829	Hydraulický zdvihák pojazdný 2ks nastaviteľné podpery	2 000 kg	130 mm	350 mm	10,5 kg	1
		2 000 kg	275 mm	420 mm	5 kg (pair)	

NASTAVITEĽNÁ PODPERA

- 1ks = 1pár
- Hrebeň pre presné nastavenie výšky s dvojitém zaistením
- Masívna oceľová rukoväť
- Veľká dosadacia plocha, silná konštrukcia rámu
- Liatinová podperná časť



Č.p.	špecifikácia	nosnosť	min výška	max výška	váha	
26857	Nastaviteľná podpera - pár; s poistkou	2 000 kg	275 mm	420 mm	4,8 kg	1
26858	Nastaviteľná podpera - pár; s poistkou	3 000 kg	285 mm	425 mm	6,3 kg	1
26859	Nastaviteľná podpera - pár; s poistkou	6 000 kg	393 mm	593 mm	13 kg	1
26853	Nastaviteľná podpera - pár	12 000 kg	465 mm	715 mm	28 kg	1

HYDRAULICKÝ ŽERIAVOVÝ ZDVIHÁK, SKLADACÍ

- Pre zdvíhanie a ukladanie agregátov pri ich montáži a demontáži
- Nosné rameno má niekoľko polôh vysunutia a podľa toho sa tiež riadi nosnosť žerjavu
- Konštrukcia v sklopnom prevedení umožňuje, aby žerjav zaberá mimo prevádzky malý priestor



Č.p.	špecifikácia	nosnosť	min výška	max výška	váha	
26862	Hydraulický žeriový zdvihák, skladací	2 000 kg	0	2360 mm	88 kg	1

OPORNÝ DRŽIAK MOTORY

· Kyvadlové zavesenie ramena držiaka v závislosti od sklonu kapoty, zaisťuje vždy vyvážené a stabilné upevnenie motora



Č.p.	špecifikácia	nosnosť	dĺžka	rozsah	váha	
26871	Oporný držiak motora	500 kg	1500 mm	150 mm	20,3 kg	1

HYDRAULICKÝ ZDVIHÁK PREVODOVKY

· Jednoduchá montáž a demontáž agregátov (motorov, prevodoviek, náprav a pod.)



Č.p.	špecifikácia	nosnosť	dĺžka	rozsah	váha	
26880	Hydraulický zdvihák prevodovky	500 kg	1100 mm	1900 mm	30,0 kg	1
26881	Nástavec pre automatické prevodovky	500 kg	1100 mm	1900 mm	15,0 kg	1

ROZPÍNACÍ SÚPRAVA

· Hydraulické zariadenie pre opravovanie karosérií vozidiel
 · Skladá sa z hydraulického rozpínacieho valca a 14-tich dielov príslušenstvo
 · Široký rozsah využitia pri opravách karosérií osobných, dodávkových a nákladných vozidiel predovšetkým v miestach, kde nie je možnosť napojenia na zdroje energie
 · Zariadenie možno využiť pre rozpínanie, stláčanie, zdvíhanie a natáhanie vo vertikálnych i horizontálnych smeroch
 · Jednoduché prenášanie v plastovom kufri



Č.p.	špecifikácia	nosnosť	hydraulický zdvih	váha	
26886	rozpínací súprava	4 000 kg	125 mm	17,0 kg	1
26888	rozpínací súprava	10 000 kg	135 mm	32,0 kg	1

STOJAN NA MOTOR

- Pojazdny stojan pre upevnenie a prácu na demontovaných motoroch
- Univerzálne upínacie jednotka umožňuje ako upnutie motora, tak jeho otáčania



Č.p.	špecifikácia	nosnosť	váha	
26920	Stojan na motor polohovateľný, pojazdný	450 kg	20 kg	1
26921	Stojan na motor polohovateľný, pojazdný	560 kg	27 kg	1
26922	Stojan na motor polohovateľný, pojazdný, skladací	675 kg	35 kg	1

RUČNÝ LANOVÝ NAVIJAK

Zn

- Kvalitný pozinkovaný navijak s odolným oceľovým lanom



Č.p.	špecifikácia	Ø Priemer lana	Max.zátěž	Dĺžka lana	
26705	Ručný lanový navijak	4,0mm	450 kg	10 m	1
26706	Ručný lanový navijak	5,0mm	900 kg	10 m	1
26707	Ručný lanový navijak	6,0mm	1350 kg	10 m	1
26720	Ručný lanový navijak	4,0mm	300 kg	10 m	1
26721	Ručný lanový navijak	4,0mm	500 kg	10 m	1
26722	Ručný lanový navijak	5,0mm	800 kg	10 m	1

REŤAZOVÝ ZDVIHÁK



Č.p.	špecifikácia	Závaž	Min. výška	Zdvih	Počet kladiek	Hrúbka reťaze	Váha	
26700	reťazový zdvihák	500 kg	280 mm	3 000 mm	1	6 mm	7,5 kg	1
26701	reťazový zdvihák	1 000 kg	300 mm	3 000 mm	1	6 mm	9 kg	1
26702	reťazový zdvihák	2 000 kg	380 mm	3 000 mm	2	6 mm	12 kg	1

STLAČOVACIE PRUŽÍN

- 26897 - pre demontáž pružín typu mopherson priamo na vozidle.
- 26943 - pre demontáž pružín typu mopherson mimo vozidla masívne ocelové profily pre väčšiu stabilitu.

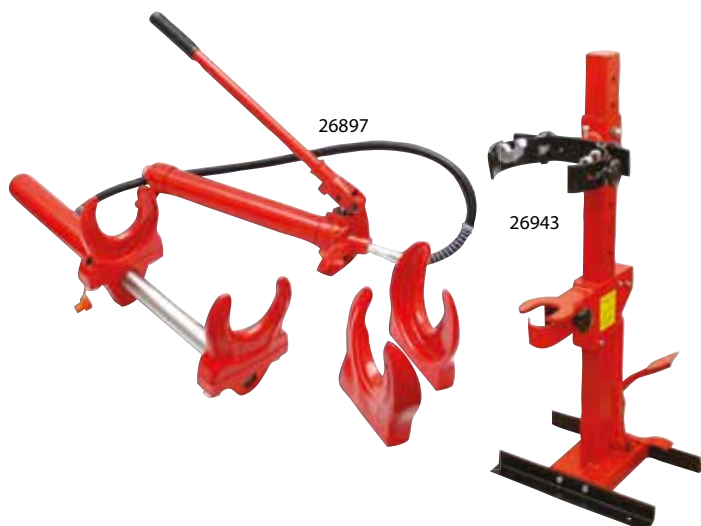

Č.p.	špecifikácia	Záťaž	Ø Stlač. pružiny	Rozpätie stlačenie	Váha	
26897	Stlačovač pružín prenosný	1 000 kg	100-200 mm	150 mm	24,5 kg	1
26943	Stlačovač pružín	1 000 kg	400 mm	210-570 mm	35 kg	1

HYDRAULICKÝ LIS



Č.p.	špecifikácia	Rozsah	Max.zátěž	Váha	
26940	Hydraulický lis	0 - 610 mm	12 000 kg	43 kg	1
26941	Hydraulický lis	0 - 880 mm	20 000 kg	75 kg	1

HYDRAULICKÁ OHÝBAČKA RÚROK

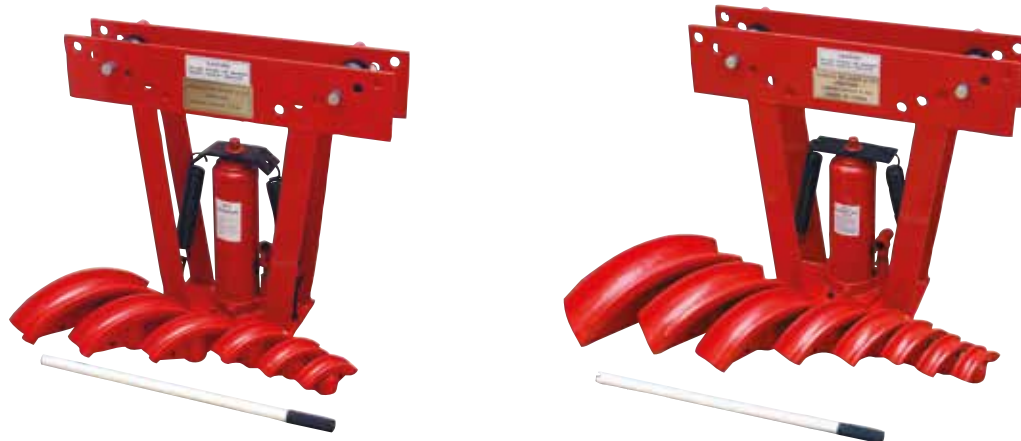

Č.p.	špecifikácia	Záťaž	Zdvih	Ohýbacie koléná	Váha	
26895		12 000 kg	232 mm	1 2", 3 4", 1", 1-1 4", 1-1 2", 2"	36 kg	1
26896		16 000 kg	238 mm	1 2", 3 4", 1", 1-1 4", 1-1 2", 2", 2-1 2", 3"	65 kg	1

HYDRAULICKÝ VÁLEC

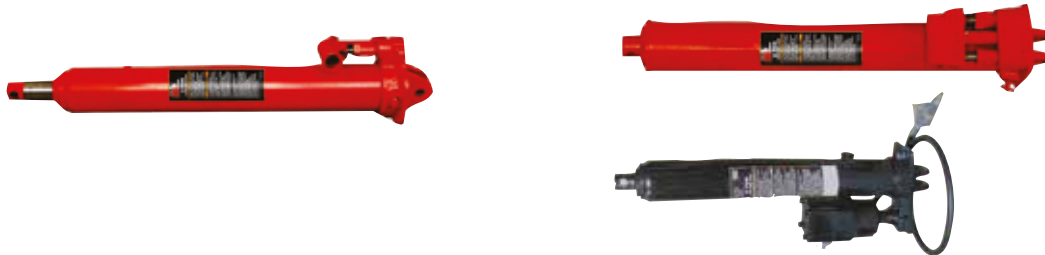

Č.p.	špecifikácia	Záťaž	Min.dĺžka (mm)	Max.dĺžka (mm)	Váha	
26911	Hydraulický válec, jednoduchá pumpa	5 000 kg	620	1100	12 kg	2
26912	Hydraulický válec, jednoduchá pumpa	8 000 kg	620	1100	13 kg	2
26914	Hydraulický válec, dvojitá pumpa	5 000 kg	620	1100	12 kg	2
26915	Hydraulický válec, dvojitá pumpa	8 000 kg	620	1100	14 kg	2



UMÝVAČKA SÚČIASTOK

· Pre bežné umývanie predmetov (súčiastky, diely strojov a pod.)



Č.p.	špecifikácia	Objem vane	Objem čistiackej kvapaliny	Prietok	Max. teplota čistiackej kvapaliny	Váha	
26961	Myčka súčastiek	90 l	45 l	10-12 l/min.	50°C	25 kg	1
26963	Myčka súčastiek	180 l	150 l	20 l/min	50°C	42 kg	1



SCEDZOVAČEJ NÁDOBA NA OLEJ



Č.p.	Objem	Max.tlak	Váha	
26953	90 l	0,2 MPa	22 kg	1

ODSÁVAČKA VYJAZDENÉHO OLEJA

- Olej sa z motora vypúšťa do vypúšťacej vaničky, odkiaľ steká do zásobníka
- Nádoba je navyše vybavená pneumatickou odsávačkou
- Vyprázdňovanie zásobníka sa vykonáva pneumaticky jeho pripojením na stlačený vzduch



Č.p.	Objem	Max.tlak	Váha	
26954	90 l	0,5 MPa	28 kg	1

ŠTAHOVÁK NA LOŽISKÁ - DVOJRAMENNÉ



Č.p.	max. priemer	hĺbka	
23734	Ø 100 mm	50-95 mm	1
23735	Ø 150 mm	100-150 mm	1
23736	Ø 200 mm	110-190 mm	1

ŠTAHOVÁK NA LOŽISKÁ - TROJRAMENNÝ



Č.p.	max. priemer	hĺbka	
23730	Ø 100 mm	50-95 mm	12
23731	Ø 150 mm	100-150 mm	2
23732	Ø 200 mm	110-190 mm	2

HYDRAULICKÝ ŠTAHOVÁK

- Sada s hydraulickým sťahovák na ložiská, náboje kolies, ozubené kolesá
- Obsahuje hydraulický skrutku, strmeň, separátor, ťažné skrutky + predĺženie
- V kovovom kufri



Č.p.	špecifikácia	Závaž	Váha	
26891	Univerzální sada hydraulických sťahováků	12 000 kg	18 kg	1

PIESKOVACÍ KABÍNA 220 L



NÁHRADNÉ DIELY K PIESKOVACIE KABÍNE

Č.p.	špecifikácia	
26973	rukavice	1
26974	trysky	1
26975	fólie 53,5 x 26 cm	1
26976	plexisklo 60 x 30 cm	1
26977	sklo 60 x 30 cm	1

Č.p.	Spotreba vzduchu	Vonkajšie rozmery	Vnútorné rozmery	Max.tlak	Váha	
26972	420-710 l/min.	1500 x 830 x 630 mm	600 x 840 x 630 mm	8 bar	38 kg	1



VOZÍK NA NÁRADIE

FESTA®



Č.p.	Pojazdy zásuviek	Zásuvky	Celkové rozmery	
26986	kluzné	7	680 x 460 x 1020 mm	1

VOZÍK NA NÁRADIE

· hornú skrinku možno uložiť do spodného vozíka



Č.p.	špecifikácia	Pojazdy zásuviek	Zásuvky	Vnútorné rozmery zásuviek ŠxHxV	Celkové rozmery	Celková váha	
26985	horná skrinka	kluzné	3	151,5 x 225 x 40 mm	600 x 260 x 340 mm	11,5 kg	1
			2	511 x 225 x 40 mm			
	spodná skrinka	kluzné	1	511 x 225 x 85 mm	616 x 330 x 742 mm	16,4 kg	
			2	511 x 308 x 85 mm			

MAGNETICKÁ MISKA



NAPÍNACIE ZARIADENIE



Č.p.	špecifikácia		Č.p.	špecifikácia	
26996	200 x 20 mm	1	50035	2 t	6
			50036	4 t	4

POJAZDNÉ KĽAKADLO



Č.p. 37135  1

MONTÁŽNE LEHÁTKO

· Čalúnené pojazdné ležadlo



Č.p. 26936 Špecifikácia 930 x 440 x 105 mm  1

MONTÁŽNE LEHÁTKO

· Plastové pojazdné ležadlo s čalúneným opierkou hlavy
· Priehradky po stranách na odkladanie náradia



Č.p. 26934 Špecifikácia 1030 x 450 x 105 mm  1

MONTÁŽNE LEHÁTKO

· Čalúnené pojazdné ležadlo s naklápacie opierkou hlavy a postrannými odkladacími priehradkami na náradie



Č.p. 26938 Špecifikácia 1030 x 440 x 105 mm  1

MONTÁŽNE SEDÁTKO

· Čalúnené pojazdné sedátko s plastovou odkladacou priehradkou



Č.p. 26988 Špecifikácia 360 x 365 x 365 mm   1

STOJAN NA MOTORY - MODEL



Č.p. 26979  1

ZDVIHÁK MOTOCYKLOV - MODEL



Č.p. 26997  1

HYDRAULICKÝ MINI ŽERIAV - MODEL



Č.p. 26998  1

číslo položky	str.	číslo položky	str.	číslo položky	str.	číslo položky	str.	číslo položky	str.	číslo položky	str.
10002	4 B	12050	9 B	13284	32 B	13462	11 B	14380	13 B	15535	18 B
10003	4 B	12110	9 B	13285	35 B	13463	11 B	14399	13 B	15540	18 B
10005	4 B	12120	9 B	13290	70 C	13464	11 B	14410	14 B	15615	18 B
10008	4 B	12130	9 B	13293	70 C	13465	11 B	14411	14 B	15620	18 B
10025	4 B	12150	9 B	13294	70 C	13466	11 B	14420	13 B	15625	18 B
10033	4 B	12210	9 B	13295	37 B	13467	11 B	14421	13 B	15630	18 B
10035	4 B	12220	9 B	13296	37 B	13468	11 B	14425	14 B	15710	18 B
10043	4 B	12230	9 B	13350	36 B	13469	11 B	14430	14 B	15715	18 B
10045	4 B	12250	9 B	13351	36 B	13470	11 B	14435	14 B	15720	18 B
10048	4 B	12433	9 B	13352	36 B	13471	11 B	14440	14 B	15725	18 B
10110	5 B	12435	9 B	13353	36 B	13472	11 B	14450	13 B	15730	18 B
10120	5 B	13010	10 B	13354	36 B	13473	11 B	14451	13 B	15735	18 B
10130	5 B	13020	10 B	13355	36 B	13500	8 B	14455	14 B	15740	18 B
10330	5 B	13021	10 B	13360	36 B	13501	8 B	14456	14 B	15810	19 B
10332	5 B	13022	10 B	13361	36 B	13502	8 B	14457	14 B	15812	19 B
10334	5 B	13023	10 B	13362	36 B	13503	8 B	14458	14 B	15815	19 B
10336	5 B	13030	10 B	13363	36 B	13504	8 B	14471	14 B	15818	19 B
10430	5 B	13111	10 B	13364	36 B	13505	8 B	14472	14 B	15820	19 B
10450	5 B	13120	10 B	13365	36 B	13506	8 B	14473	14 B	15825	19 B
10490	5 B	13205	35 B	13399	11 B	13507	8 B	14474	14 B	15830	19 B
10996	5 B	13210	10 B	13400	11 B	13508	8 B	14480	10 B	15850	19 B
10998	5 B	13211	10 B	13401	11 B	13509	8 B	14490	14 B	15853	19 B
10999	5 B	13212	35 B	13402	11 B	13510	8 B	14491	14 B	15855	19 B
11002	7 B	13214	34 B	13403	11 B	13511	8 B	14492	14 B	15860	19 B
11003	7 B	13216	34 B	13404	11 B	13512	8 B	14493	14 B	15870	19 B
11005	7 B	13217	34 B	13405	11 B	13513	8 B	14494	14 B	15880	19 B
11006	7 B	13218	34 B	13406	11 B	13514	8 B	15003	16 B	15885	225 E
11007	7 B	13219	34 B	13407	11 B	13515	8 B	15004	16 B	15886	225 E
11008	7 B	13220	10 B	13408	11 B	13516	8 B	15005	16 B	15886	345 F
11082	7 B	13222	34 B	13409	11 B	13517	8 B	15006	16 B	15887	225 E
11083	7 B	13223	34 B	13410	11 B	13518	8 B	15008	16 B	15887	345 F
11085	7 B	13224	34 B	13411	11 B	13519	8 B	15010	16 B	15888	225 E
11102	7 B	13225	34 B	13412	11 B	13520	8 B	15012	16 B	15888	345 F
11103	7 B	13226	34 B	13413	11 B	13521	8 B	15015	16 B	15889	225 E
11105	7 B	13227	34 B	13414	11 B	13522	8 B	15018	16 B	15904	20 B
11106	7 B	13228	34 B	13415	11 B	13523	8 B	15020	16 B	15906	20 B
11107	7 B	13229	34 B	13416	11 B	13524	8 B	15033	15 B	15908	20 B
11110	7 B	13230	34 B	13417	11 B	13525	8 B	15034	15 B	15910	20 B
11200	7 B	13231	34 B	13418	11 B	13526	8 B	15035	15 B	15912	20 B
11201	7 B	13235	34 B	13419	11 B	13527	8 B	15036	15 B	15915	20 B
11202	7 B	13236	34 B	13420	11 B	13528	8 B	15037	15 B	15920	20 B
11204	7 B	13237	34 B	13421	11 B	13529	8 B	15039	15 B	15954	20 B
11205	7 B	13238	34 B	13422	11 B	13530	8 B	15103	16 B	15956	20 B
11206	7 B	13240	33 B	13423	11 B	13531	8 B	15104	16 B	15958	20 B
11207	7 B	13241	33 B	13424	11 B	13532	8 B	15105	16 B	15960	20 B
11208	7 B	13242	33 B	13425	11 B	13533	8 B	15106	16 B	15962	20 B
11209	7 B	13243	33 B	13426	11 B	13534	8 B	15108	16 B	15965	20 B
11210	7 B	13244	33 B	13427	11 B	14001	12 B	15110	16 B	15970	20 B
11220	6 B	13245	33 B	13428	11 B	14002	12 B	15112	16 B	15980	22 B
11221	6 B	13249	36 B	13429	11 B	14003	12 B	15115	16 B	15981	22 B
11226	6 B	13250	36 B	13430	11 B	14004	12 B	15118	16 B	15983	9 B
11239	6 B	13251	36 B	13431	11 B	14006	12 B	15120	16 B	15985	9 B
11259	6 B	13252	36 B	13432	11 B	14007	12 B	15204	17 B	15988	9 B
11260	6 B	13253	36 B	13433	11 B	14008	12 B	15205	17 B	15989	9 B
11311	8 B	13254	36 B	13434	11 B	14009	12 B	15206	17 B	15990	22 B
11312	8 B	13255	37 B	13435	11 B	14010	10 B	15208	17 B	15991	22 B
11313	8 B	13256	37 B	13436	11 B	14011	10 B	15210	17 B	15992	22 B
11314	8 B	13257	37 B	13437	11 B	14012	10 B	15212	17 B	15993	22 B
11323	6 B	13258	37 B	13438	11 B	14013	12 B	15215	17 B	15996	19 B
11325	6 B	13259	37 B	13439	11 B	14015	10 B	15218	17 B	15997	19 B
11327	6 B	13260	33 B	13440	11 B	14017	10 B	15220	17 B	15998	19 B
11333	7 B	13261	33 B	13441	11 B	14019	10 B	15230	17 B	15999	19 B
11335	7 B	13262	32 B	13442	11 B	14025	14 B	15235	17 B	16002	136 D
11337	7 B	13263	32 B	13443	11 B	14030	10 B	15310	17 B	16003	136 D
11338	7 B	13264	32 B	13444	11 B	14035	12 B	15315	17 B	16004	137 D
11343	6 B	13265	32 B	13445	11 B	14040	12 B	15318	17 B	16005	137 D
11345	6 B	13266	32 B	13446	11 B	14045	12 B	15320	17 B	16006	137 D
11347	6 B	13268	32 B	13447	11 B	14060	13 B	15325	17 B	16010	137 D
11353	6 B	13269	32 B	13448	11 B	14070	13 B	15330	17 B	16010	137 D
11355	6 B	13270	32 B	13449	11 B	14075	13 B	15335	17 B	16011	136 D
11356	6 B	13271	32 B	13450	11 B	14080	12 B	15340	17 B	16011	136 D
11358	6 B	13272	32 B	13451	11 B	14090	14 B	15415	18 B	16011	137 D
11360	6 B	13273	33 B	13452	11 B	14091	14 B	15418	18 B	16012	136 D
11410	8 B	13274	33 B	13453	11 B	14220	13 B	15420	18 B	16012	136 D
11416	7 B	13275	33 B	13454	11 B	14225	13 B	15425	18 B	16012	137 D
11420	8 B	13276	33 B	13455	11 B	14230	13 B	15430	18 B	16013	137 D
11425	8 B	13277	33 B	13456	11 B	14235	13 B	15510	18 B	16013	137 D
11444	8 B	13278	32 B	13457	11 B	14240	13 B	15515	18 B	16014	137 D
11445	8 B	13279	32 B	13458	11 B	14250	13 B	15518	18 B	16016	137 D
12010	9 B	13280	32 B	13459	11 B	14350	13 B	15520	18 B	16017	137 D
12020	9 B	13281	35 B	13460	11 B	14360	13 B	15525	18 B	16019	136 D
12030	9 B	13282	35 B	13461	11 B	14370	13 B	15530	18 B	16021	143 D

REGISTER POLOŽIEK



číslo položky	str.	číslo položky	str.	číslo položky	str.	číslo položky	str.	číslo položky	str.	číslo položky	str.
16022	147 D	16147	140 D	17026	153 D	17128	42 C	17259	85 C	17422	63 C
16023	141 D	16150	138 D	17027	153 D	17130	42 C	17260	84 C	17427	64 C
16024	143 D	16151	138 D	17028	47 C	17133	42 C	17261	69 C	17450	69 C
16025	140 D	16198	150 D	17029	47 C	17135	42 C	17262	69 C	17451	69 C
16026	143 D	16199	150 D	17033	44 C	17137	42 C	17292	59 C	17455	64 C
16028	143 D	16201	147 D	17034	46 C	17138	42 C	17294	59 C	17456	64 C
16029	140 D	16209	149 D	17035	46 C	17140	40 C	17295	59 C	17460	66 C
16030	142 D	16210	148 D	17036	46 C	17141	40 C	17296	59 C	17461	66 C
16031	142 D	16211	148 D	17038	47 C	17142	40 C	17297	59 C	17462	66 C
16032	142 D	16212	147 D	17039	47 C	17145	40 C	17298	59 C	17463	66 C
16033	142 D	16218	148 D	17040	43 C	17146	40 C	17299	59 C	17464	66 C
16034	140 D	16219	148 D	17041	43 C	17148	40 C	17300	46 C	17465	66 C
16035	142 D	16220	148 D	17042	43 C	17155	49 C	17301	46 C	17466	66 C
16036	142 D	16221	148 D	17043	43 C	17156	49 C	17302	46 C	17467	66 C
16037	141 D	16222	149 D	17044	43 C	17158	50 C	17304	46 C	17468	66 C
16038	142 D	16223	149 D	17045	43 C	17159	50 C	17305	46 C	17469	66 C
16041	142 D	16224	149 D	17046	47 C	17160	50 C	17308	60 C	17470	66 C
16042	144 D	16225	147 D	17048	47 C	17165	49 C	17309	60 C	17471	66 C
16042	251 E	16226	149 D	17050	50 C	17167	49 C	17310	60 C	17472	66 C
16043	143 D	16227	149 D	17050	153 D	17169	49 C	17311	60 C	17473	66 C
16046	143 D	16228	149 D	17051	47 C	17170	49 C	17312	60 C	17475	67 C
16049	144 D	16229	147 D	17052	47 C	17175	49 C	17313	60 C	17476	67 C
16050	144 D	16230	147 D	17053	47 C	17177	49 C	17314	60 C	17480	66 C
16051	144 D	16231	99 C	17054	47 C	17180	42 C	17315	60 C	17481	66 C
16052	144 D	16231	147 D	17055	47 C	17181	42 C	17316	60 C	17482	66 C
16053	143 D	16232	42 C	17056	47 C	17182	152 D	17317	60 C	17483	66 C
16054	144 D	16232	150 D	17057	47 C	17183	152 D	17318	60 C	17484	66 C
16055	143 D	16234	147 D	17058	47 C	17185	50 C	17319	60 C	17485	66 C
16056	251 E	16235	148 D	17059	44 C	17186	49 C	17320	60 C	17486	66 C
16057	141 D	16236	148 D	17060	44 C	17187	113 C	17321	60 C	17487	65 C
16058	141 D	16281	151 D	17061	44 C	17188	113 C	17322	60 C	17488	65 C
16059	144 D	16282	151 D	17062	44 C	17189	113 C	17324	60 C	17489	65 C
16060	146 D	16300	154 D	17063	45 C	17190	43 C	17327	60 C	17490	65 C
16061	146 D	16301	154 D	17064	45 C	17191	43 C	17330	60 C	17491	65 C
16062	145 D	16303	154 D	17065	45 C	17192	43 C	17332	60 C	17492	65 C
16063	145 D	16304	154 D	17066	45 C	17193	43 C	17333	60 C	17493	65 C
16064	145 D	16310	154 D	17067	45 C	17197	66 C	17334	60 C	17494	65 C
16065	145 D	16310	154 D	17068	45 C	17198	66 C	17335	55 C	17495	65 C
16066	138 D	16311	154 D	17069	45 C	17199	66 C	17336	55 C	17496	65 C
16066	145 D	16311	154 D	17070	45 C	17200	66 C	17337	55 C	17501	68 C
16067	145 D	16311	154 D	17071	45 C	17201	66 C	17338	55 C	17506	67 C
16068	145 D	16312	154 D	17072	45 C	17202	66 C	17345	54 C	17508	67 C
16069	144 D	16312	154 D	17075	45 C	17203	69 C	17346	54 C	17512	67 C
16070	144 D	16315	153 D	17076	45 C	17204	69 C	17350	88 C	17526	67 C
16070	146 D	16315	153 D	17077	45 C	17205	69 C	17351	88 C	17528	67 C
16071	141 D	16320	154 D	17079	44 C	17206	69 C	17352	88 C	17532	67 C
16071	146 D	16401	50 C	17080	44 C	17208	55 C	17353	88 C	17533	67 C
16072	146 D	16405	50 C	17081	44 C	17210	51 C	17357	88 C	17534	67 C
16073	146 D	16406	50 C	17082	44 C	17211	51 C	17359	88 C	17539	67 C
16074	141 D	16407	50 C	17083	46 C	17212	52 C	17360	88 C	17548	65 C
16074	146 D	16408	50 C	17084	44 C	17213	52 C	17361	88 C	17549	65 C
16075	146 D	16420	50 C	17085	44 C	17214	52 C	17380	64 C	17550	65 C
16077	145 D	16990	151 D	17086	44 C	17215	52 C	17381	64 C	17551	65 C
16078	145 D	16990	306 F	17089	48 C	17216	53 C	17382	63 C	17552	65 C
16081	145 D	16991	151 D	17090	48 C	17217	53 C	17383	63 C	17553	65 C
16082	144 D	16991	306 F	17091	48 C	17218	53 C	17384	63 C	17554	65 C
16083	146 D	16998	137 D	17092	48 C	17219	53 C	17385	63 C	17555	65 C
16084	146 D	16999	137 D	17093	48 C	17220	55 C	17386	63 C	17556	65 C
16085	141 D	17001	41 C	17094	41 C	17222	55 C	17390	64 C	17557	65 C
16086	141 D	17002	41 C	17095	41 C	17224	55 C	17391	64 C	17558	65 C
16090	139 D	17003	41 C	17096	41 C	17225	54 C	17392	64 C	17559	65 C
16091	139 D	17004	41 C	17097	41 C	17226	54 C	17393	64 C	17560	65 C
16095	141 D	17005	41 C	17098	41 C	17227	54 C	17394	64 C	17561	65 C
16100	138 D	17006	41 C	17099	41 C	17229	56 C	17395	64 C	17562	65 C
16104	136 D	17007	41 C	17100	41 C	17230	57 C	17396	64 C	17563	65 C
16105	138 D	17008	41 C	17101	40 C	17231	57 C	17397	64 C	17564	65 C
16110	138 D	17009	41 C	17102	40 C	17233	57 C	17398	64 C	17565	65 C
16115	138 D	17010	41 C	17103	40 C	17234	57 C	17400	64 C	17566	65 C
16120	138 D	17011	41 C	17104	40 C	17235	58 C	17401	63 C	17567	65 C
16125	138 D	17012	44 C	17105	40 C	17236	58 C	17402	63 C	17568	65 C
16130	140 D	17013	44 C	17108	41 C	17237	58 C	17405	63 C	17569	65 C
16131	138 D	17014	44 C	17109	43 C	17238	56 C	17406	63 C	17570	65 C
16135	140 D	17015	46 C	17110	41 C	17238	85 C	17407	63 C	17571	65 C
16136	139 D	17016	46 C	17111	48 C	17240	59 C	17410	63 C	17572	65 C
16137	139 D	17017	46 C	17112	48 C	17241	59 C	17411	63 C	17573	65 C
16140	140 D	17019	46 C	17116	48 C	17242	59 C	17412	63 C	17574	65 C
16141	143 D	17020	47 C	17117	48 C	17243	59 C	17413	63 C	17575	65 C
16142	139 D	17021	47 C	17121	48 C	17244	59 C	17414	63 C	17576	65 C
16143	139 D	17022	47 C	17122	48 C	17245	56 C	17415	63 C	17577	65 C
16144	139 D	17023	46 C	17125	42 C	17247	85 C	17416	63 C	17578	65 C
16145	139 D	17024	41 C	17126	42 C	17250	55 C	17420	63 C	17579	65 C
16146	140 D	17025	43 C	17127	42 C	17255	55 C	17421	63 C	17580	65 C

číslo položky	str.	číslo položky	str.	číslo položky	str.	číslo položky	str.	číslo položky	str.	číslo položky	str.
17581	65 C	17762	66 C	17902	61 C	18212	71 C	18519	87 C	18750	79 C
17582	65 C	17766	66 C	17904	61 C	18215	71 C	18520	87 C	18751	79 C
17583	65 C	17769	66 C	17905	61 C	18216	71 C	18521	87 C	18753	79 C
17584	65 C	17788	66 C	17907	61 C	18301	75 C	18522	87 C	18755	79 C
17585	65 C	17789	66 C	17910	61 C	18302	75 C	18523	87 C	18760	79 C
17586	65 C	17795	66 C	17912	61 C	18303	75 C	18524	87 C	18761	79 C
17587	65 C	17806	66 C	17913	61 C	18304	75 C	18527	87 C	18762	79 C
17589	65 C	17810	60 C	17914	61 C	18310	71 C	18540	87 C	18763	79 C
17590	65 C	17811	60 C	17916	61 C	18311	71 C	18541	87 C	18764	79 C
17591	65 C	17820	60 C	17921	61 C	18312	71 C	18542	87 C	18765	79 C
17592	65 C	17821	60 C	17922	61 C	18313	71 C	18543	87 C	18766	79 C
17593	65 C	17822	60 C	17924	61 C	18321	71 C	18544	87 C	18767	79 C
17600	69 C	17823	60 C	17925	61 C	18322	71 C	18545	87 C	18768	79 C
17601	69 C	17824	60 C	17926	61 C	18340	73 C	18546	87 C	18769	79 C
17602	69 C	17825	60 C	17927	61 C	18350	72 C	18547	87 C	18770	79 C
17603	69 C	17826	60 C	17930	61 C	18351	72 C	18548	87 C	18771	79 C
17605	66 C	17827	60 C	17931	61 C	18352	72 C	18549	87 C	18772	79 C
17606	66 C	17828	60 C	17932	61 C	18353	72 C	18550	87 C	18775	79 C
17607	66 C	17829	60 C	17933	61 C	18354	72 C	18551	87 C	18776	79 C
17608	66 C	17830	60 C	17934	61 C	18355	72 C	18552	87 C	18777	79 C
17609	66 C	17831	60 C	17935	61 C	18356	72 C	18553	87 C	18795	81 C
17610	66 C	17832	60 C	17943	61 C	18357	72 C	18554	87 C	18796	81 C
17611	66 C	17835	61 C	17944	61 C	18358	72 C	18557	87 C	18797	81 C
17612	66 C	17836	61 C	17970	80 C	18359	72 C	18559	87 C	18798	81 C
17613	66 C	17837	61 C	17971	80 C	18360	72 C	18562	87 C	18799	81 C
17614	66 C	17838	61 C	17972	80 C	18400	75 C	18567	87 C	18800	80 C
17615	66 C	17839	61 C	17973	80 C	18401	75 C	18572	87 C	18801	80 C
17616	66 C	17840	61 C	17974	80 C	18402	73 C	18575	87 C	18802	80 C
17617	66 C	17841	61 C	17975	80 C	18403	73 C	18576	87 C	18803	80 C
17620	68 C	17842	61 C	17976	80 C	18404	73 C	18577	87 C	18804	80 C
17621	68 C	17843	61 C	17980	80 C	18408	77 C	18578	87 C	18805	80 C
17622	65 C	17844	61 C	17981	80 C	18409	77 C	18579	87 C	18806	80 C
17623	65 C	17845	61 C	17982	80 C	18410	74 C	18580	87 C	18807	80 C
17624	65 C	17846	61 C	17983	80 C	18411	74 C	18581	87 C	18810	80 C
17625	65 C	17847	61 C	18062	72 C	18413	74 C	18582	87 C	18811	80 C
17626	65 C	17848	61 C	18063	72 C	18415	77 C	18583	87 C	18812	80 C
17628	65 C	17849	61 C	18064	72 C	18416	77 C	18584	87 C	18813	80 C
17629	65 C	17850	61 C	18065	72 C	18417	77 C	18585	87 C	18814	80 C
17630	65 C	17851	61 C	18066	72 C	18418	75 C	18586	87 C	18815	80 C
17631	65 C	17852	61 C	18067	72 C	18419	77 C	18587	87 C	18816	80 C
17632	65 C	17853	61 C	18070	72 C	18420	77 C	18588	87 C	18817	80 C
17633	65 C	17854	61 C	18071	72 C	18421	84 C	18589	87 C	18820	80 C
17640	68 C	17855	61 C	18072	72 C	18422	73 C	18593	87 C	18821	80 C
17642	68 C	17856	61 C	18075	72 C	18423	74 C	18600	81 C	18822	80 C
17643	68 C	17860	60 C	18076	72 C	18424	73 C	18601	81 C	18823	80 C
17644	68 C	17861	60 C	18077	72 C	18425	76 C	18602	81 C	18824	80 C
17645	68 C	17862	60 C	18080	72 C	18426	74 C	18603	59 C	18825	80 C
17650	68 C	17863	60 C	18081	72 C	18430	84 C	18604	64 C	18826	80 C
17651	68 C	17864	60 C	18082	72 C	18431	77 C	18607	81 C	18827	80 C
17652	68 C	17865	60 C	18083	72 C	18433	76 C	18608	76 C	18828	80 C
17653	68 C	17866	60 C	18084	72 C	18435	76 C	18609	81 C	18829	80 C
17654	68 C	17867	60 C	18085	72 C	18437	74 C	18610	82 C	18830	80 C
17655	68 C	17868	60 C	18086	72 C	18440	84 C	18611	82 C	18831	80 C
17656	68 C	17869	60 C	18087	72 C	18450	76 C	18612	82 C	18832	80 C
17657	68 C	17870	60 C	18088	72 C	18451	76 C	18613	82 C	18835	80 C
17658	68 C	17871	60 C	18089	72 C	18455	72 C	18614	82 C	18836	80 C
17659	68 C	17872	60 C	18090	72 C	18456	72 C	18615	82 C	18837	80 C
17660	65 C	17873	60 C	18091	72 C	18460	72 C	18618	82 C	18838	80 C
17661	65 C	17874	60 C	18092	72 C	18466	87 C	18619	64 C	18839	80 C
17662	65 C	17875	60 C	18101	75 C	18468	87 C	18619	81 C	18840	80 C
17663	65 C	17876	60 C	18102	75 C	18476	87 C	18620	79 C	18841	80 C
17664	65 C	17877	60 C	18103	75 C	18477	87 C	18621	79 C	18842	80 C
17665	65 C	17878	60 C	18104	75 C	18490	86 C	18623	79 C	18843	80 C
17666	65 C	17879	60 C	18105	75 C	18491	86 C	18625	79 C	18844	80 C
17667	65 C	17880	60 C	18106	75 C	18492	86 C	18627	79 C	18845	80 C
17668	65 C	17881	60 C	18107	75 C	18493	86 C	18628	79 C	18846	80 C
17669	65 C	17882	60 C	18108	75 C	18494	88 C	18630	79 C	18847	80 C
17670	65 C	17883	60 C	18110	76 C	18495	88 C	18631	79 C	18850	80 C
17671	65 C	17884	60 C	18113	71 C	18496	86 C	18632	79 C	18851	80 C
17672	65 C	17885	60 C	18114	71 C	18497	86 C	18633	79 C	18852	80 C
17674	65 C	17886	60 C	18115	71 C	18498	86 C	18634	79 C	18853	80 C
17675	65 C	17887	60 C	18116	71 C	18499	88 C	18635	79 C	18855	80 C
17676	65 C	17888	60 C	18118	71 C	18500	86 C	18636	79 C	18856	80 C
17677	65 C	17889	60 C	18120	71 C	18508	87 C	18637	79 C	18860	80 C
17678	65 C	17890	60 C	18124	71 C	18510	87 C	18638	79 C	18861	80 C
17679	65 C	17891	60 C	18125	71 C	18511	87 C	18639	79 C	18862	80 C
17680	68 C	17892	60 C	18201	75 C	18512	87 C	18640	79 C	18863	80 C
17681	68 C	17895	61 C	18202	75 C	18513	87 C	18641	79 C	18864	80 C
17682	68 C	17896	61 C	18203	75 C	18514	87 C	18645	79 C	18865	80 C
17683	65 C	17897	61 C	18204	75 C	18515	87 C	18646	79 C	18866	80 C
17685	66 C	17898	61 C	18210	71 C	18516	87 C	18680	79 C	18867	80 C
17761	66 C	17900	61 C	18211	71 C	18518	87 C	18685	79 C	18868	81 C

REGISTER POLOŽIEK



číslo položky	str.	číslo položky	str.	číslo položky	str.	číslo položky	str.	číslo položky	str.	číslo položky	str.
18869	81 C	19061	90 C	19360	96 C	19481	173 D	19577	158 D	19645	158 D
18870	81 C	19062	91 C	19370	96 C	19482	173 D	19578	158 D	19646	158 D
18871	81 C	19063	91 C	19371	96 C	19483	173 D	19579	158 D	19647	158 D
18872	81 C	19064	90 C	19380	95 C	19485	172 D	19580	158 D	19648	158 D
18873	81 C	19065	91 C	19381	95 C	19486	172 D	19580	158 D	19649	158 D
18874	81 C	19066	90 C	19382	95 C	19487	172 D	19581	158 D	19650	158 D
18900	83 C	19067	90 C	19383	95 C	19490	99 C	19582	158 D	19650	158 D
18901	83 C	19068	90 C	19384	95 C	19491	99 C	19583	158 D	19651	158 D
18905	83 C	19069	90 C	19385	95 C	19492	99 C	19584	158 D	19652	158 D
18906	83 C	19070	90 C	19387	95 C	19493	99 C	19585	158 D	19653	158 D
18907	84 C	19071	90 C	19388	95 C	19494	99 C	19585	158 D	19654	158 D
18909	83 C	19074	89 C	19389	95 C	19495	99 C	19586	158 D	19655	158 D
18910	76 C	19075	89 C	19390	96 C	19496	99 C	19587	158 D	19656	158 D
18915	84 C	19076	89 C	19391	95 C	19497	99 C	19588	158 D	19657	158 D
18916	84 C	19077	89 C	19392	96 C	19498	99 C	19589	158 D	19658	158 D
18920	62 C	19081	89 C	19394	97 C	19499	99 C	19590	158 D	19659	158 D
18921	62 C	19082	89 C	19395	97 C	19501	99 C	19590	158 D	19660	158 D
18922	62 C	19083	89 C	19396	97 C	19502	99 C	19591	158 D	19661	158 D
18925	62 C	19084	89 C	19397	97 C	19510	100 C	19592	158 D	19662	158 D
18926	62 C	19085	89 C	19398	92 C	19515	100 C	19593	158 D	19663	158 D
18927	62 C	19086	89 C	19399	92 C	19520	100 C	19594	158 D	19664	158 D
18928	62 C	19088	89 C	19400	98 C	19530	158 D	19595	158 D	19665	158 D
18929	62 C	19090	89 C	19401	98 C	19530	158 D	19595	158 D	19669	158 D
18930	62 C	19092	89 C	19402	98 C	19531	158 D	19596	158 D	19670	159 D
18931	62 C	19095	89 C	19403	98 C	19532	158 D	19597	158 D	19671	159 D
18934	62 C	19096	89 C	19404	98 C	19533	158 D	19598	158 D	19672	159 D
18935	62 C	19097	89 C	19405	98 C	19534	158 D	19599	158 D	19673	159 D
18937	62 C	19098	89 C	19406	98 C	19535	158 D	19600	158 D	19673	159 D
18939	62 C	19100	91 C	19407	98 C	19535	158 D	19600	158 D	19674	159 D
18944	62 C	19106	89 C	19408	98 C	19536	158 D	19601	158 D	19675	159 D
18945	62 C	19108	89 C	19409	98 C	19537	158 D	19602	158 D	19676	159 D
18948	62 C	19109	89 C	19410	98 C	19538	158 D	19603	158 D	19677	159 D
18950	62 C	19110	100 C	19410	172 D	19539	158 D	19604	158 D	19678	159 D
18951	62 C	19115	92 C	19411	98 C	19540	158 D	19605	158 D	19678	159 D
18954	62 C	19115	116 C	19411	172 D	19540	158 D	19605	158 D	19679	159 D
18955	62 C	19124	92 C	19412	98 C	19541	158 D	19606	158 D	19680	159 D
18956	62 C	19136	92 C	19412	172 D	19542	158 D	19607	158 D	19681	159 D
18957	62 C	19148	92 C	19415	97 C	19543	158 D	19608	158 D	19682	159 D
18960	62 C	19149	92 C	19416	97 C	19544	158 D	19609	158 D	19683	159 D
18961	62 C	19150	91 C	19418	98 C	19545	158 D	19610	158 D	19683	159 D
18963	62 C	19151	90 C	19418	172 D	19545	158 D	19610	158 D	19684	159 D
18967	62 C	19200	93 C	19419	98 C	19546	158 D	19611	158 D	19685	159 D
18968	62 C	19202	93 C	19419	172 D	19547	158 D	19612	158 D	19686	159 D
18969	62 C	19208	94 C	19421	97 C	19548	158 D	19613	158 D	19687	159 D
18970	62 C	19209	94 C	19422	97 C	19549	158 D	19614	158 D	19688	159 D
18971	62 C	19211	94 C	19423	97 C	19550	158 D	19615	158 D	19688	159 D
18972	62 C	19245	93 C	19424	97 C	19550	158 D	19615	158 D	19689	159 D
18993	82 C	19246	93 C	19425	97 C	19551	158 D	19616	158 D	19690	159 D
18994	82 C	19247	93 C	19426	97 C	19552	158 D	19617	158 D	19691	159 D
19001	90 C	19248	93 C	19427	97 C	19552	158 D	19618	158 D	19692	159 D
19002	90 C	19249	93 C	19429	172 D	19553	158 D	19619	158 D	19693	159 D
19003	90 C	19251	94 C	19430	92 C	19554	158 D	19620	158 D	19693	159 D
19004	90 C	19252	94 C	19431	92 C	19555	158 D	19620	158 D	19694	159 D
19005	90 C	19253	94 C	19432	92 C	19555	158 D	19621	158 D	19695	159 D
19006	90 C	19254	93 C	19433	92 C	19556	158 D	19622	158 D	19695	159 D
19008	90 C	19255	93 C	19434	92 C	19557	158 D	19623	158 D	19696	159 D
19010	90 C	19265	93 C	19435	92 C	19558	158 D	19624	158 D	19697	159 D
19015	90 C	19270	93 C	19436	98 C	19558	158 D	19625	158 D	19698	159 D
19020	90 C	19271	93 C	19436	172 D	19559	158 D	19625	158 D	19698	159 D
19021	90 C	19272	93 C	19440	92 C	19560	158 D	19626	158 D	19699	159 D
19022	90 C	19290	93 C	19441	92 C	19560	158 D	19627	158 D	19700	159 D
19023	90 C	19294	93 C	19442	92 C	19561	158 D	19628	158 D	19701	159 D
19024	90 C	19295	93 C	19443	92 C	19562	158 D	19629	158 D	19701	159 D
19025	90 C	19297	94 C	19450	99 C	19562	158 D	19630	158 D	19702	159 D
19026	90 C	19301	96 C	19451	99 C	19563	158 D	19630	158 D	19703	159 D
19028	90 C	19303	91 C	19455	99 C	19564	158 D	19631	158 D	19703	159 D
19030	90 C	19306	95 C	19457	99 C	19565	158 D	19632	158 D	19704	159 D
19031	90 C	19308	95 C	19458	100 C	19565	158 D	19633	158 D	19705	159 D
19032	90 C	19310	95 C	19459	100 C	19566	158 D	19634	158 D	19705	159 D
19034	90 C	19312	95 C	19460	98 C	19567	158 D	19635	158 D	19706	159 D
19036	90 C	19314	95 C	19462	97 C	19568	158 D	19635	158 D	19707	159 D
19050	90 C	19326	96 C	19463	97 C	19568	158 D	19636	158 D	19708	159 D
19051	91 C	19328	96 C	19464	97 C	19569	158 D	19637	158 D	19708	159 D
19052	91 C	19330	96 C	19465	97 C	19570	158 D	19638	158 D	19709	159 D
19053	90 C	19332	96 C	19469	97 C	19570	158 D	19639	158 D	19710	159 D
19054	90 C	19335	96 C	19470	98 C	19571	158 D	19640	158 D	19711	159 D
19055	90 C	19337	96 C	19472	173 D	19572	158 D	19640	158 D	19711	159 D
19056	90 C	19340	95 C	19473	173 D	19573	158 D	19641	158 D	19712	159 D
19057	90 C	19344	96 C	19474	173 D	19574	158 D	19642	158 D	19713	159 D
19058	90 C	19354	96 C	19477	173 D	19575	158 D	19643	158 D	19713	159 D
19059	90 C	19356	96 C	19478	173 D	19575	158 D	19644	158 D	19714	159 D
19060	91 C	19357	96 C	19480	173 D	19576	158 D	19645	158 D	19715	159 D

číslo položky	str.	číslo položky	str.	číslo položky	str.	číslo položky	str.	číslo položky	str.	číslo položky	str.
19716	159 D	19783	159 D	20411	160 D	20740	174 D	20905	174 D	21211	203 D
19717	159 D	19784	159 D	20412	160 D	20741	174 D	20910	174 D	21212	203 D
19718	159 D	19785	159 D	20413	160 D	20744	168 D	20911	174 D	21215	203 D
19718	159 D	19786	159 D	20414	160 D	20744	178 D	20912	174 D	21218	203 D
19719	159 D	19786	159 D	20415	160 D	20745	178 D	20913	174 D	21219	203 D
19720	159 D	19787	159 D	20416	160 D	20748	166 D	20915	174 D	21220	203 D
19721	159 D	19788	159 D	20417	160 D	20749	166 D	20916	174 D	21223	203 D
19722	159 D	19789	159 D	20418	160 D	20750	166 D	20917	174 D	21224	203 D
19723	159 D	19790	159 D	20419	160 D	20751	166 D	20918	174 D	21301	205 D
19723	159 D	19791	159 D	20420	160 D	20752	166 D	20919	174 D	21303	205 D
19724	159 D	19792	159 D	20421	160 D	20753	166 D	20920	174 D	21306	207 D
19725	159 D	19793	159 D	20422	160 D	20754	166 D	20921	174 D	21308	207 D
19726	159 D	19794	159 D	20423	160 D	20755	166 D	20922	174 D	21311	203 D
19727	159 D	19795	159 D	20424	160 D	20756	166 D	20923	174 D	21312	203 D
19728	159 D	19796	159 D	20425	160 D	20757	166 D	20924	174 D	21315	203 D
19728	159 D	19797	159 D	20426	160 D	20758	166 D	20936	168 D	21318	203 D
19729	159 D	19798	159 D	20427	160 D	20759	166 D	20937	168 D	21323	203 D
19730	159 D	19799	159 D	20428	160 D	20760	166 D	20938	168 D	21324	203 D
19731	159 D	19800	159 D	20429	160 D	20761	166 D	20939	168 D	21325	203 D
19732	159 D	19801	159 D	20430	160 D	20762	166 D	20940	168 D	21326	203 D
19733	159 D	19802	159 D	20450	175 D	20764	166 D	20941	168 D	21410	204 D
19733	159 D	19841	160 D	20460	175 D	20765	166 D	20942	168 D	21411	204 D
19734	159 D	19842	160 D	20487	163 D	20766	166 D	20943	168 D	21412	204 D
19735	159 D	19845	160 D	20488	163 D	20767	166 D	20944	168 D	21415	204 D
19736	159 D	19885	160 D	20489	163 D	20768	166 D	20945	168 D	21418	204 D
19737	159 D	19895	160 D	20490	163 D	20769	166 D	20946	168 D	21423	204 D
19738	159 D	20210	175 D	20491	163 D	20770	166 D	20947	168 D	21424	204 D
19738	159 D	20220	160 D	20492	163 D	20771	166 D	20948	168 D	21425	205 D
19739	159 D	20225	160 D	20493	163 D	20772	166 D	20949	168 D	21426	205 D
19740	159 D	20230	160 D	20494	163 D	20773	166 D	20950	167 D	21427	205 D
19741	159 D	20235	160 D	20495	163 D	20774	166 D	20952	167 D	21428	205 D
19742	159 D	20240	160 D	20496	163 D	20775	166 D	20954	168 D	21430	205 D
19743	159 D	20245	160 D	20510	167 D	20776	166 D	20956	168 D	21431	205 D
19743	159 D	20250	160 D	20511	167 D	20777	166 D	20957	174 D	21432	205 D
19744	159 D	20255	160 D	20512	167 D	20778	166 D	20958	174 D	21440	174 D
19745	159 D	20260	160 D	20513	167 D	20779	166 D	20960	178 D	21441	174 D
19746	159 D	20270	160 D	20514	167 D	20780	166 D	20961	178 D	21442	174 D
19747	159 D	20280	160 D	20515	167 D	20781	166 D	20963	178 D	21443	174 D
19748	159 D	20290	160 D	20516	167 D	20782	166 D	20965	178 D	21444	174 D
19748	159 D	20296	160 D	20520	167 D	20783	166 D	20966	178 D	21445	174 D
19749	159 D	20300	162 D	20521	167 D	20784	166 D	20967	68 C	21446	174 D
19750	159 D	20305	162 D	20522	167 D	20785	166 D	20968	68 C	21450	175 D
19751	159 D	20310	162 D	20523	167 D	20786	166 D	20969	68 C	21451	175 D
19752	159 D	20311	162 D	20524	167 D	20787	166 D	20970	178 D	21452	175 D
19753	159 D	20315	162 D	20525	167 D	20788	166 D	20971	178 D	21453	176 D
19753	159 D	20316	161 D	20526	167 D	20789	166 D	20972	178 D	21454	176 D
19754	159 D	20317	161 D	20673	166 D	20790	166 D	20973	178 D	21530	175 D
19755	159 D	20320	162 D	20674	166 D	20791	166 D	20980	174 D	21540	176 D
19756	159 D	20321	162 D	20675	166 D	20792	166 D	20981	174 D	21541	176 D
19757	159 D	20333	161 D	20676	166 D	20793	166 D	20982	174 D	21701	186 D
19758	159 D	20334	161 D	20677	166 D	20794	166 D	20983	174 D	21702	186 D
19758	159 D	20335	161 D	20678	166 D	20795	166 D	20984	174 D	21703	186 D
19759	159 D	20336	161 D	20680	166 D	20796	166 D	20990	168 D	21704	186 D
19760	159 D	20337	161 D	20682	166 D	20797	166 D	20991	168 D	21705	186 D
19761	159 D	20338	161 D	20684	166 D	20798	166 D	20992	168 D	21706	186 D
19762	159 D	20350	173 D	20685	166 D	20799	166 D	20999	167 D	21709	186 D
19763	159 D	20360	154 D	20686	166 D	20805	167 D	21010	204 D	21715	186 D
19763	159 D	20361	154 D	20687	166 D	20820	167 D	21011	204 D	21716	186 D
19764	159 D	20363	49 C	20688	166 D	20825	166 D	21012	204 D	21717	186 D
19765	159 D	20365	178 D	20690	166 D	20855	166 D	21015	204 D	21718	186 D
19766	159 D	20379	170 D	20691	166 D	20861	166 D	21018	204 D	21719	186 D
19767	159 D	20380	162 D	20692	166 D	20862	166 D	21023	204 D	21720	186 D
19768	159 D	20381	177 D	20694	166 D	20870	166 D	21110	204 D	21721	186 D
19768	159 D	20385	165 D	20696	166 D	20871	166 D	21111	204 D	21724	186 D
19769	159 D	20386	165 D	20697	166 D	20872	166 D	21112	204 D	21732	186 D
19770	159 D	20387	165 D	20698	166 D	20873	166 D	21115	204 D	21734	186 D
19771	159 D	20390	165 D	20724	174 D	20874	166 D	21118	204 D	21735	186 D
19772	159 D	20391	165 D	20725	174 D	20875	166 D	21123	204 D	21736	186 D
19772	159 D	20395	165 D	20726	174 D	20876	166 D	21130	204 D	21737	186 D
19773	159 D	20396	165 D	20727	174 D	20877	166 D	21135	204 D	21740	186 D
19774	159 D	20397	165 D	20728	174 D	20878	166 D	21140	204 D	21741	186 D
19775	159 D	20400	160 D	20729	174 D	20879	166 D	21150	204 D	21742	186 D
19776	159 D	20401	160 D	20730	174 D	20880	166 D	21180	204 D	21743	186 D
19776	159 D	20402	160 D	20731	174 D	20881	166 D	21190	204 D	21744	186 D
19777	159 D	20403	160 D	20732	174 D	20890	167 D	21192	207 D	21750	186 D
19778	159 D	20404	160 D	20733	174 D	20891	167 D	21194	207 D	21751	186 D
19779	159 D	20405	160 D	20734	174 D	20895	167 D	21195	205 D	21752	186 D
19780	159 D	20406	160 D	20735	174 D	20896	174 D	21200	203 D	21753	186 D
19781	159 D	20407	160 D	20736	174 D	20897	174 D	21201	203 D	21754	186 D
19781	159 D	20408	160 D	20737	174 D	20898	174 D	21203	203 D	21780	208 D
19782	159 D	20409	160 D	20738	174 D	20899	174 D	21204	203 D	21781	208 D
19783	159 D	20410	160 D	20739	174 D	20901	175 D	21210	203 D	21782	208 D

REGISTER POLOŽIEK



číslo položky	str.	číslo položky	str.	číslo položky	str.	číslo položky	str.	číslo položky	str.	číslo položky	str.
21783	208 D	22018	181 D	22102	187 D	22207	189 D	22515	157 D	23291	363 G
21784	208 D	22019	181 D	22103	187 D	22208	189 D	22520	157 D	23292	363 G
21786	208 D	22020	181 D	22104	187 D	22209	189 D	22525	157 D	23296	363 G
21787	208 D	22021	181 D	22105	187 D	22211	206 D	22530	157 D	23297	363 G
21788	208 D	22022	181 D	22106	187 D	22212	206 D	22532	157 D	23310	361 G
21789	208 D	22023	180 D	22107	187 D	22215	206 D	22535	157 D	23311	361 G
21790	208 D	22024	180 D	22108	187 D	22216	206 D	22540	157 D	23312	361 G
21792	208 D	22025	180 D	22109	187 D	22217	206 D	22542	157 D	23390	363 G
21793	208 D	22026	181 D	22110	187 D	22218	206 D	22545	157 D	23391	363 G
21794	208 D	22027	181 D	22111	187 D	22219	206 D	22548	157 D	23400	109 C
21795	208 D	22028	181 D	22112	187 D	22220	206 D	22550	157 D	23401	109 C
21796	208 D	22029	181 D	22113	187 D	22222	206 D	22555	157 D	23402	109 C
21798	184 D	22030	181 D	22115	187 D	22224	206 D	22560	157 D	23406	109 C
21798	208 D	22031	181 D	22116	187 D	22225	206 D	22565	157 D	23407	109 C
21800	209 D	22032	181 D	22117	187 D	22230	207 D	22568	157 D	23410	108 C
21801	209 D	22033	182 D	22120	188 D	22232	207 D	22570	157 D	23411	108 C
21802	209 D	22034	182 D	22121	188 D	22234	207 D	22575	157 D	23412	108 C
21810	185 D	22035	182 D	22122	188 D	22236	207 D	22580	157 D	23415	108 C
21811	185 D	22036	182 D	22123	188 D	22238	207 D	22585	157 D	23416	108 C
21812	185 D	22037	180 D	22124	188 D	22240	206 D	22590	157 D	23417	108 C
21813	185 D	22038	180 D	22125	188 D	22242	206 D	22595	157 D	23420	109 C
21814	185 D	22039	180 D	22126	188 D	22244	206 D	22600	157 D	23506	108 C
21831	185 D	22040	180 D	22129	188 D	22246	206 D	22602	157 D	23507	108 C
21832	185 D	22041	183 D	22130	188 D	22248	206 D	22605	157 D	23508	108 C
21834	185 D	22042	183 D	22132	188 D	22251	206 D	22610	157 D	23515	108 C
21850	187 D	22043	183 D	22133	188 D	22252	206 D	22615	157 D	23520	108 C
21851	187 D	22044	183 D	22134	188 D	22253	206 D	22620	157 D	23525	108 C
21852	187 D	22045	185 D	22135	343 F	22254	206 D	22625	157 D	23530	108 C
21853	187 D	22046	185 D	22136	343 F	22255	206 D	22630	157 D	23531	108 C
21854	187 D	22047	185 D	22137	343 F	22258	206 D	22701	183 D	23551	108 C
21855	187 D	22048	185 D	22138	343 F	22259	206 D	22702	183 D	23560	107 C
21856	187 D	22049	185 D	22140	208 D	22263	206 D	22703	183 D	23561	107 C
21857	187 D	22050	185 D	22141	208 D	22264	206 D	22704	183 D	23562	107 C
21858	187 D	22051	185 D	22142	208 D	22266	206 D	22705	183 D	23563	107 C
21859	187 D	22052	185 D	22143	208 D	22270	206 D	22706	183 D	23564	107 C
21860	187 D	22053	185 D	22145	208 D	22273	206 D	22707	183 D	23565	107 C
21861	187 D	22054	185 D	22146	208 D	22274	206 D	23000	360 G	23566	107 C
21862	187 D	22055	185 D	22147	208 D	22275	206 D	23001	360 G	23570	107 C
21863	187 D	22056	185 D	22148	208 D	22277	206 D	23005	362 G	23571	107 C
21864	187 D	22057	185 D	22150	208 D	22280	206 D	23006	362 G	23572	107 C
21900	179 D	22058	181 D	22151	208 D	22281	206 D	23010	362 G	23573	107 C
21901	179 D	22059	181 D	22155	208 D	22285	206 D	23020	362 G	23574	107 C
21902	179 D	22060	183 D	22156	208 D	22286	206 D	23025	362 G	23585	108 C
21903	179 D	22061	183 D	22158	182 D	22294	207 D	23030	362 G	23587	108 C
21904	179 D	22062	183 D	22159	182 D	22300	191 D	23035	362 G	23589	108 C
21905	179 D	22063	183 D	22160	185 D	22301	191 D	23040	362 G	23591	108 C
21906	179 D	22064	183 D	22161	185 D	22302	191 D	23050	362 G	23600	108 C
21907	180 D	22065	184 D	22162	185 D	22303	191 D	23060	362 G	23601	108 C
21908	180 D	22066	184 D	22163	185 D	22305	191 D	23070	362 G	23602	108 C
21909	180 D	22067	186 D	22164	185 D	22307	191 D	23125	361 G	23605	108 C
21910	180 D	22068	184 D	22165	185 D	22309	191 D	23130	361 G	23620	108 C
21911	180 D	22069	184 D	22166	185 D	22310	191 D	23135	361 G	23625	108 C
21912	180 D	22070	184 D	22167	185 D	22311	191 D	23140	361 G	23626	108 C
21913	180 D	22071	184 D	22168	185 D	22312	191 D	23150	361 G	23628	108 C
21914	180 D	22072	184 D	22169	185 D	22313	191 D	23160	361 G	23630	108 C
21920	179 D	22073	183 D	22170	190 D	22314	191 D	23211	361 G	23632	108 C
21925	179 D	22074	183 D	22171	190 D	22315	191 D	23212	361 G	23650	109 C
21926	179 D	22075	186 D	22172	190 D	22317	191 D	23213	361 G	23660	109 C
21930	181 D	22076	186 D	22173	190 D	22318	191 D	23214	361 G	23670	107 C
21931	181 D	22077	186 D	22174	190 D	22319	191 D	23215	361 G	23671	107 C
21935	181 D	22078	182 D	22178	189 D	22320	191 D	23220	361 G	23672	107 C
21936	181 D	22079	182 D	22180	189 D	22322	191 D	23225	361 G	23673	107 C
21937	181 D	22080	182 D	22181	189 D	22324	191 D	23232	361 G	23674	107 C
21940	181 D	22081	182 D	22182	189 D	22326	191 D	23240	361 G	23675	107 C
21941	181 D	22082	182 D	22183	189 D	22328	191 D	23250	361 G	23676	107 C
22001	179 D	22083	184 D	22184	189 D	22329	191 D	23260	361 G	23677	107 C
22002	179 D	22084	184 D	22185	189 D	22332	191 D	23261	361 G	23678	107 C
22003	179 D	22085	184 D	22186	189 D	22333	191 D	23262	361 G	23679	107 C
22004	180 D	22086	182 D	22188	190 D	22335	191 D	23263	361 G	23680	107 C
22005	180 D	22087	183 D	22189	190 D	22337	191 D	23264	361 G	23681	107 C
22006	180 D	22088	184 D	22190	190 D	22340	191 D	23265	361 G	23682	107 C
22007	179 D	22090	184 D	22195	190 D	22343	191 D	23266	361 G	23683	107 C
22008	179 D	22091	184 D	22197	190 D	22345	191 D	23270	360 G	23684	107 C
22009	179 D	22092	184 D	22198	190 D	22350	191 D	23273	361 G	23685	107 C
22010	179 D	22093	184 D	22199	190 D	22351	191 D	23274	361 G	23730	113 C
22011	179 D	22095	184 D	22200	170 D	22355	191 D	23275	361 G	23730	401 H
22012	180 D	22096	185 D	22201	170 D	22357	191 D	23281	363 G	23731	113 C
22013	180 D	22097	185 D	22202	190 D	22365	191 D	23282	363 G	23731	401 H
22014	180 D	22098	185 D	22203	190 D	22370	191 D	23284	363 G	23732	113 C
22015	180 D	22099	185 D	22204	190 D	22398	191 D	23287	362 G	23732	401 H
22016	180 D	22100	187 D	22205	190 D	22399	191 D	23288	362 G	23734	113 C
22017	180 D	22101	187 D	22206	189 D	22510	157 D	23290	363 G	23734	401 H

číslo položky	str.	číslo položky	str.	číslo položky	str.	číslo položky	str.	číslo položky	str.	číslo položky	str.
23735	113 C	23987	112 C	24144	199 D	24511	103 C	24731	168 D	25170	285 E
23735	401 H	23988	112 C	24145	199 D	24515	103 C	24732	168 D	25171	285 E
23736	113 C	23989	112 C	24147	199 D	24516	103 C	24735	170 D	25179	284 E
23736	401 H	24000	111 C	24148	199 D	24517	103 C	24736	170 D	25180	284 E
23760	102 C	24001	111 C	24149	199 D	24518	104 C	24737	170 D	25181	284 E
23761	102 C	24002	111 C	24150	200 D	24519	104 C	24738	170 D	25182	284 E
23762	102 C	24005	111 C	24151	200 D	24520	103 C	24739	170 D	25183	284 E
23763	102 C	24006	111 C	24152	201 D	24521	104 C	24740	170 D	25184	284 E
23764	102 C	24007	110 C	24152	301 F	24522	104 C	24741	170 D	25186	284 E
23800	102 C	24010	110 C	24153	197 D	24530	105 C	24743	170 D	25188	284 E
23810	370 G	24015	111 C	24154	200 D	24531	105 C	24745	169 D	25189	284 E
23814	370 G	24017	111 C	24155	202 D	24532	105 C	24746	170 D	25190	284 E
23816	370 G	24020	111 C	24156	202 D	24533	105 C	24747	169 D	25195	284 E
23818	370 G	24030	111 C	24158	202 D	24534	105 C	24748	170 D	25206	284 E
23820	370 G	24035	112 C	24159	188 D	24535	105 C	24749	170 D	25212	284 E
23824	370 G	24036	112 C	24159	202 D	24536	105 C	24750	164 D	25215	284 E
23826	370 G	24038	112 C	24160	196 D	24537	105 C	24751	164 D	25220	284 E
23828	370 G	24039	112 C	24161	196 D	24538	105 C	24755	176 D	25224	284 E
23830	370 G	24040	112 C	24162	196 D	24539	105 C	24756	176 D	25230	284 E
23840	307 F	24041	112 C	24163	196 D	24540	105 C	24757	169 D	25240	284 E
23845	306 F	24042	112 C	24164	196 D	24541	105 C	24758	169 D	25248	284 E
23846	306 F	24043	112 C	24165	196 D	24542	105 C	24759	169 D	25260	284 E
23847	306 F	24045	193 D	24166	196 D	24543	105 C	24760	171 D	25296	284 E
23850	370 G	24050	195 D	24167	196 D	24545	105 C	24761	171 D	25350	284 E
23854	370 G	24055	192 D	24168	196 D	24546	105 C	24762	171 D	25365	285 E
23856	370 G	24055	249 E	24169	196 D	24547	105 C	24763	171 D	25366	285 E
23858	370 G	24060	192 D	24170	198 D	24550	105 C	24764	171 D	25367	285 E
23860	370 G	24061	192 D	24171	199 D	24551	105 C	24765	171 D	25368	285 E
23864	370 G	24062	192 D	24173	200 D	24552	105 C	24766	171 D	25369	284 E
23865	370 G	24063	192 D	24174	202 D	24553	105 C	24767	171 D	25370	284 E
23866	370 G	24064	192 D	24175	202 D	24555	105 C	24768	171 D	25371	284 E
23868	370 G	24065	192 D	24176	202 D	24556	105 C	24769	171 D	25372	284 E
23870	370 G	24066	192 D	24177	202 D	24557	105 C	24770	170 D	25373	284 E
23880	370 G	24067	192 D	24178	202 D	24558	105 C	24771	170 D	25374	284 E
23882	370 G	24068	192 D	24180	197 D	24560	105 C	24772	170 D	25376	284 E
23884	370 G	24069	192 D	24181	202 D	24561	105 C	24773	170 D	25378	284 E
23904	102 C	24070	192 D	24185	196 D	24562	105 C	24774	170 D	25379	284 E
23906	102 C	24071	192 D	24186	196 D	24565	106 C	24780	171 D	25380	284 E
23908	102 C	24072	192 D	24187	196 D	24567	105 C	24781	171 D	25400	285 E
23910	102 C	24073	192 D	24188	196 D	24568	105 C	24782	171 D	25410	285 E
23912	102 C	24074	192 D	24189	196 D	24569	105 C	24783	171 D	26021	31 B
23914	102 C	24075	192 D	24190	188 D	24570	106 C	24784	171 D	26021	123 C
23920	102 C	24076	192 D	24190	202 D	24571	106 C	24785	171 D	26028	22 B
23922	102 C	24077	192 D	24192	196 D	24572	106 C	24786	171 D	26037	29 B
23923	101 C	24078	192 D	24195	196 D	24573	106 C	24787	171 D	26205	22 B
23924	101 C	24080	193 D	24196	196 D	24574	106 C	24788	171 D	26215	21 B
23925	101 C	24081	193 D	24197	196 D	24575	106 C	24789	171 D	26216	21 B
23927	101 C	24082	193 D	24212	374 G	24577	106 C	24790	171 D	26217	21 B
23928	102 C	24083	193 D	24225	374 G	24578	106 C	24791	171 D	26218	21 B
23930	106 C	24084	193 D	24250	374 G	24580	105 C	24792	171 D	26260	26 B
23931	106 C	24085	193 D	24255	374 G	24581	105 C	24793	171 D	26343	25 B
23932	106 C	24086	193 D	24258	374 G	24582	105 C	24794	171 D	26395	29 B
23934	106 C	24087	193 D	24260	374 G	24583	105 C	24795	171 D	26429	27 B
23935	106 C	24098	193 D	24301	194 D	24584	105 C	24796	171 D	26430	27 B
23936	106 C	24099	193 D	24302	194 D	24690	178 D	24798	171 D	26431	27 B
23945	101 C	24100	197 D	24303	194 D	24691	178 D	25001	285 E	26440	30 B
23950	112 C	24102	197 D	24304	194 D	24695	178 D	25002	285 E	26441	30 B
23951	112 C	24103	197 D	24305	194 D	24700	171 D	25003	285 E	26460	23 B
23952	112 C	24104	197 D	24306	194 D	24701	171 D	25004	285 E	26464	23 B
23953	112 C	24108	196 D	24308	195 D	24702	171 D	25005	285 E	26479	25 B
23954	112 C	24109	197 D	24310	195 D	24703	171 D	25006	284 E	26493	31 B
23955	112 C	24110	198 D	24312	195 D	24704	171 D	25009	284 E	26495	31 B
23960	102 C	24111	198 D	24313	195 D	24705	171 D	25012	284 E	26520	24 B
23961	102 C	24118	197 D	24314	196 D	24706	177 D	25015	284 E	26521	24 B
23962	102 C	24119	197 D	24315	195 D	24712	177 D	25016	284 E	26523	28 B
23963	102 C	24120	196 D	24410	164 D	24713	177 D	25020	284 E	26524	29 B
23964	102 C	24121	198 D	24411	164 D	24714	177 D	25024	284 E	26526	30 B
23965	102 C	24122	198 D	24419	164 D	24715	177 D	25025	284 E	26527	23 B
23966	102 C	24124	198 D	24420	164 D	24716	177 D	25030	284 E	26528	26 B
23967	102 C	24125	198 D	24422	164 D	24717	169 D	25040	284 E	26700	398 H
23970	112 C	24126	198 D	24425	164 D	24718	169 D	25048	284 E	26701	398 H
23971	112 C	24128	200 D	24429	164 D	24719	169 D	25060	284 E	26702	398 H
23972	112 C	24130	199 D	24432	164 D	24720	177 D	25096	284 E	26705	288 E
23973	112 C	24131	199 D	24435	164 D	24721	177 D	25150	284 E	26705	398 H
23974	112 C	24133	199 D	24437	164 D	24722	177 D	25153	284 E	26706	288 E
23975	112 C	24135	200 D	24444	164 D	24723	169 D	25155	284 E	26706	398 H
23976	112 C	24136	200 D	24451	164 D	24725	169 D	25160	285 E	26707	288 E
23977	112 C	24137	200 D	24457	164 D	24726	169 D	25162	285 E	26707	398 H
23978	112 C	24140	200 D	24464	164 D	24727	259 E	25163	285 E	26720	288 E
23979	112 C	24141	200 D	24476	164 D	24728	259 E	25164	285 E	26720	398 H
23985	112 C	24142	200 D	24483	164 D	24729	259 E	25167	285 E	26721	288 E
23986	112 C	24143	199 D	24510	103 C	24730	168 D	25169	285 E	26721	398 H

REGISTER POLOŽIEK



číslo položky	str.	číslo položky	str.	číslo položky	str.	číslo položky	str.	číslo položky	str.	číslo položky	str.
26722	288 E	31008	213 E	31501	218 E	32226	220 E	33201	389 G	34154	226 E
26722	398 H	31009	213 E	31502	218 E	32234	220 E	33202	389 G	34155	226 E
26775	260 E	31011	213 E	31503	218 E	32240	220 E	33202	389 G	34156	226 E
26780	267 E	31021	213 E	31505	217 E	32265	233 E	33203	389 G	34157	226 E
26781	267 E	31031	213 E	31506	217 E	32268	233 E	33203	389 G	34158	226 E
26782	267 E	31041	213 E	31507	217 E	32269	233 E	33205	389 G	34159	226 E
26783	267 E	31051	213 E	31510	216 E	32270	233 E	33205	389 G	34160	226 E
26800	394 H	31052	214 E	31511	216 E	32273	233 E	33206	389 G	34167	232 E
26801	394 H	31053	213 E	31512	216 E	32283	233 E	33206	389 G	34168	232 E
26802	394 H	31061	214 E	31513	216 E	32285	233 E	33207	389 G	34200	226 E
26803	394 H	31062	214 E	31514	216 E	32293	233 E	33207	389 G	34201	226 E
26804	394 H	31071	214 E	31515	216 E	32295	233 E	33208	389 G	34202	226 E
26805	394 H	31072	214 E	31520	217 E	32296	233 E	33208	389 G	34203	226 E
26806	394 H	31081	214 E	31521	217 E	32297	233 E	33208	389 G	34203	226 E
26807	394 H	31082	213 E	31522	217 E	32298	233 E	33209	389 G	34221	228 E
26815	394 H	31091	212 E	31523	217 E	32301	233 E	33209	389 G	34222	231 E
26816	394 H	31101	212 E	31524	217 E	32302	233 E	33210	389 G	34223	228 E
26817	394 H	31111	212 E	31525	217 E	32312	222 E	33210	389 G	34224	229 E
26819	394 H	31121	212 E	31526	217 E	32313	233 E	33211	389 G	34225	229 E
26820	395 H	31131	212 E	31541	217 E	32314	223 E	33211	389 G	34226	229 E
26824	395 H	31132	212 E	31551	217 E	32315	224 E	33212	389 G	34227	228 E
26825	395 H	31140	212 E	31552	218 E	32316	224 E	33212	389 G	34228	228 E
26826	395 H	31141	212 E	31553	218 E	32317	222 E	33215	389 G	34228	228 E
26829	396 H	31142	212 E	31555	217 E	32317	222 E	33215	389 G	34231	231 E
26840	395 H	31143	212 E	31556	217 E	32318	223 E	33220	390 G	34232	231 E
26844	394 H	31144	212 E	31557	217 E	32318	223 E	33220	390 G	34233	230 E
26845	394 H	31145	212 E	31558	217 E	32319	223 E	33221	390 G	34235	231 E
26853	396 H	31146	212 E	31559	217 E	32320	223 E	33221	390 G	34236	230 E
26857	396 H	31148	212 E	31601	221 E	32322	223 E	33246	391 G	34237	231 E
26858	396 H	31150	213 E	31602	221 E	32323	223 E	33247	391 G	34238	230 E
26859	396 H	31151	213 E	31603	221 E	32324	223 E	33248	391 G	34241	228 E
26862	396 H	31155	213 E	31641	221 E	32325	224 E	33249	391 G	34243	228 E
26871	397 H	31218	216 E	31651	221 E	32326	224 E	33250	390 G	34251	229 E
26880	397 H	31220	214 E	31655	221 E	32327	222 E	33250	390 G	34253	229 E
26881	397 H	31221	214 E	32001	219 E	32328	224 E	33252	390 G	34261	229 E
26886	397 H	31222	214 E	32002	219 E	32328	388 G	33252	390 G	34262	228 E
26888	397 H	31231	214 E	32003	219 E	32329	223 E	33254	390 G	34264	230 E
26891	401 H	31232	214 E	32013	219 E	32330	223 E	33254	390 G	34265	230 E
26895	399 H	31233	214 E	32014	219 E	32331	223 E	33255	390 G	34266	231 E
26896	399 H	31234	214 E	32015	219 E	32335	224 E	33255	390 G	34267	231 E
26897	399 H	31235	214 E	32016	219 E	32337	222 E	33256	390 G	34271	226 E
26911	400 H	31270	215 E	32018	219 E	32418	223 E	33256	390 G	34272	226 E
26912	400 H	31271	215 E	32019	219 E	32421	223 E	33257	390 G	34273	226 E
26914	400 H	31280	215 E	32020	219 E	33100	386 G	33257	390 G	34274	226 E
26915	400 H	31281	215 E	32021	219 E	33102	386 G	33258	390 G	34275	226 E
26920	398 H	31320	215 E	32022	221 E	33105	386 G	33258	390 G	34276	226 E
26921	398 H	31322	215 E	32023	221 E	33107	386 G	33270	391 G	34280	226 E
26922	398 H	31330	215 E	32024	219 E	33110	386 G	33275	267 E	34281	226 E
26934	403 H	31332	215 E	32026	219 E	33112	386 G	33275	391 G	34282	226 E
26936	403 H	31334	214 E	32037	221 E	33113	386 G	33280	391 G	34283	226 E
26938	403 H	31340	215 E	32040	221 E	33114	386 G	33285	391 G	34284	226 E
26940	399 H	31341	215 E	32041	221 E	33120	386 G	33286	391 G	34285	226 E
26941	399 H	31343	214 E	32042	221 E	33123	386 G	33289	391 G	34290	228 E
26943	399 H	31343	214 E	32043	221 E	33124	386 G	33289	391 G	34291	228 E
26943	399 H	31360	214 E	32044	221 E	33127	387 G	33291	391 G	34291	228 E
26953	400 H	31362	214 E	32050	221 E	33127	387 G	33292	391 G	34292	228 E
26954	400 H	31380	214 E	32051	221 E	33131	387 G	33293	391 G	34295	229 E
26961	400 H	31382	214 E	32052	221 E	33132	387 G	33298	391 G	34296	229 E
26963	400 H	31390	214 E	32053	221 E	33135	387 G	33299	391 G	34298	230 E
26972	401 H	31392	214 E	32060	219 E	33137	387 G	34005	225 E	34299	230 E
26973	401 H	31400	214 E	32062	219 E	33140	387 G	34006	225 E	34300	260 E
26974	401 H	31402	214 E	32066	219 E	33141	387 G	34007	225 E	34301	226 E
26975	401 H	31403	214 E	32066	219 E	33142	387 G	34027	224 E	34303	260 E
26976	401 H	31404	214 E	32076	219 E	33143	387 G	34033	232 E	34304	226 E
26977	401 H	31452	218 E	32161	220 E	33150	387 G	34041	225 E	34305	218 E
26979	403 H	31453	218 E	32162	220 E	33151	387 G	34051	225 E	34306	218 E
26985	402 H	31454	218 E	32163	220 E	33152	387 G	34053	225 E	34307	218 E
26986	402 H	31455	216 E	32163	220 E	33154	387 G	34061	226 E	34308	218 E
26988	403 H	31456	216 E	32164	220 E	33155	390 G	34071	226 E	34315	188 D
26996	402 H	31461	216 E	32165	220 E	33160	388 G	34081	226 E	34316	146 D
26997	403 H	31467	216 E	32166	220 E	33162	388 G	34091	226 E	34316	188 D
26998	403 H	31468	216 E	32167	220 E	33163	388 G	34101	226 E	34316	188 D
30003	224 E	31471	216 E	32168	220 E	33164	388 G	34111	226 E	34400	228 E
30003	232 E	31481	216 E	32169	220 E	33166	388 G	34111	226 E	34401	228 E
30004	224 E	31491	216 E	32170	216 E	33166	388 G	34115	226 E	34402	231 E
30004	232 E	31493	218 E	32171	220 E	33167	388 G	34116	226 E	34403	231 E
30005	224 E	31494	218 E	32172	220 E	33168	223 E	34117	226 E	34404	229 E
30005	232 E	31495	218 E	32173	216 E	33168	223 E	34118	226 E	34405	228 E
30007	224 E	31496	218 E	32174	220 E	33169	388 G	34119	226 E	34406	230 E
30007	232 E	31497	218 E	32176	220 E	33170	388 G	34121	226 E	34407	231 E
31005	213 E	31498	216 E	32186	220 E	33173	388 G	34122	226 E	34409	229 E
31006	213 E	31499	216 E	32196	220 E	33200	389 G	34132	226 E	34410	229 E
31007	213 E	31500	216 E	32206	220 E	33200	389 G	34142	226 E	34411	231 E
				32216	220 E	33201	389 G	34152	226 E	34412	230 E
								34153	226 E	34413	230 E

číslo položky	str.	číslo položky	str.	číslo položky	str.	číslo položky	str.	číslo položky	str.	číslo položky	str.
34414	232 E	35085	235 E	35552	241 E	37096	255 E	37236	261 E	37539	244 E
34415	228 E	35086	235 E	35553	241 E	37097	255 E	37237	261 E	37541	244 E
34416	228 E	35087	235 E	35555	241 E	37098	255 E	37238	261 E	37545	246 E
34417	231 E	35091	235 E	35603	244 E	37101	221 E	37239	261 E	37546	246 E
34418	231 E	35092	235 E	35604	244 E	37111	221 E	37243	283 E	37549	246 E
34419	229 E	35093	235 E	35605	244 E	37114	261 E	37244	283 E	37560	246 E
34420	228 E	35094	235 E	35833	239 E	37115	261 E	37245	283 E	37564	245 E
34421	230 E	35095	235 E	35845	239 E	37117	250 E	37246	283 E	37570	200 D
34422	231 E	35096	235 E	35850	239 E	37119	261 E	37247	283 E	37570	246 E
34423	231 E	35103	238 E	36014	249 E	37120	261 E	37248	283 E	37600	289 E
34424	230 E	35113	238 E	36024	249 E	37121	267 E	37250	283 E	37601	289 E
34425	229 E	35123	238 E	36034	249 E	37122	267 E	37251	283 E	37602	289 E
34426	229 E	35125	238 E	36035	249 E	37123	381 G	37252	283 E	37603	289 E
34428	230 E	35126	238 E	36036	249 E	37124	381 G	37253	283 E	37604	289 E
34429	232 E	35127	238 E	36046	249 E	37125	254 E	37255	271 E	37605	289 E
34440	228 E	35300	234 E	36056	250 E	37126	254 E	37256	271 E	37606	289 E
34441	228 E	35310	234 E	36057	250 E	37127	254 E	37257	271 E	37611	289 E
34442	229 E	35311	234 E	36058	250 E	37129	381 G	37258	271 E	37615	289 E
34443	229 E	35316	234 E	36059	250 E	37130	253 E	37259	271 E	37616	289 E
34445	228 E	35317	234 E	36076	248 E	37131	253 E	37263	271 E	37621	379 G
34446	228 E	35318	234 E	36077	248 E	37132	253 E	37264	271 E	37630	379 G
34447	229 E	35319	234 E	36080	248 E	37135	128 C	37266	271 E	37640	378 G
34448	231 E	35320	276 E	36081	248 E	37135	403 H	37267	271 E	37641	378 G
34449	228 E	35320	372 G	36082	248 E	37139	128 C	37268	271 E	37645	378 G
34450	228 E	35322	276 E	36085	248 E	37140	128 C	37270	271 E	37650	379 G
34451	228 E	35322	372 G	36086	248 E	37141	128 C	37271	271 E	37730	238 E
34452	231 E	35323	156 D	36087	248 E	37142	128 C	37272	271 E	37730	372 G
34453	229 E	35323	258 E	36126	249 E	37143	128 C	37273	271 E	37731	238 E
34454	228 E	35325	156 D	36128	249 E	37144	128 C	37275	271 E	37731	372 G
34455	230 E	35325	258 E	36130	249 E	37145	128 C	37280	272 E	37760	238 E
34456	231 E	35326	156 D	36136	249 E	37148	253 E	37281	272 E	37760	372 G
34457	231 E	35326	258 E	36145	247 E	37149	253 E	37290	283 E	37761	238 E
34458	230 E	35327	156 D	36160	247 E	37150	253 E	37291	283 E	37761	372 G
34459	232 E	35327	258 E	36175	247 E	37151	253 E	37295	272 E	38000	274 E
34460	228 E	35328	156 D	36190	247 E	37152	253 E	37295	370 G	38001	273 E
34461	228 E	35328	258 E	36191	247 E	37153	253 E	37296	272 E	38002	274 E
34462	231 E	35329	156 D	36199	248 E	37154	253 E	37296	370 G	38003	274 E
34463	231 E	35329	258 E	36200	248 E	37155	253 E	37297	272 E	38004	274 E
34464	229 E	35330	155 D	36240	248 E	37156	253 E	37297	370 G	38005	274 E
34465	228 E	35330	257 E	36300	246 E	37157	253 E	37300	132 C	38006	273 E
34466	230 E	35331	155 D	36305	373 G	37158	253 E	37301	132 C	38007	274 E
34467	231 E	35331	257 E	36306	373 G	37166	245 E	37302	132 C	38008	274 E
34468	231 E	35335	156 D	36308	260 E	37170	254 E	37303	132 C	38009	274 E
34469	230 E	35335	258 E	36310	245 E	37171	254 E	37308	133 C	38010	273 E
34470	229 E	35345	155 D	36312	260 E	37172	254 E	37309	133 C	38012	273 E
34471	229 E	35345	257 E	36313	373 G	37173	254 E	37310	131 C	38013	273 E
34472	228 E	35346	155 D	36314	373 G	37174	254 E	37311	130 C	38014	274 E
34473	228 E	35346	257 E	36318	373 G	37175	254 E	37312	131 C	38014	274 E
34474	228 E	35347	155 D	36319	373 G	37176	254 E	37313	131 C	38015	275 E
34475	228 E	35347	155 D	37005	279 E	37177	254 E	37314	131 C	38016	275 E
34476	228 E	35347	257 E	37006	251 E	37178	254 E	37317	299 F	38017	275 E
34477	229 E	35347	257 E	37006	251 E	37185	254 E	37320	131 C	38018	275 E
34478	231 E	35350	328 F	37007	251 E	37186	254 E	37321	131 C	38020	273 E
34479	232 E	35360	118 C	37007	251 E	37187	254 E	37325	129 C	38021	275 E
34480	228 E	35361	118 C	37008	251 E	37188	254 E	37326	129 C	38022	275 E
34481	228 E	35362	118 C	37009	251 E	37189	254 E	37328	129 C	38024	273 E
34482	228 E	35500	240 E	37010	391 G	37190	254 E	37330	130 C	38025	273 E
34485	229 E	35501	240 E	37011	251 E	37195	253 E	37331	129 C	38026	252 E
34486	229 E	35502	240 E	37012	251 E	37196	253 E	37332	130 C	38026	276 E
34490	230 E	35503	240 E	37021	251 E	37197	253 E	37340	133 C	38030	276 E
34491	230 E	35504	240 E	37025	250 E	37198	253 E	37341	132 C	38031	275 E
34496	231 E	35505	240 E	37025	250 E	37200	252 E	37342	132 C	38042	252 E
34500	232 E	35506	240 E	37026	250 E	37201	252 E	37343	133 C	38042	276 E
35006	236 E	35507	240 E	37026	250 E	37202	252 E	37344	133 C	38050	268 E
35007	236 E	35508	240 E	37028	250 E	37203	252 E	37345	133 C	38052	268 E
35011	237 E	35510	240 E	37028	250 E	37204	252 E	37350	131 C	38054	268 E
35012	236 E	35511	240 E	37029	250 E	37205	252 E	37500	242 E	38055	268 E
35013	236 E	35512	240 E	37029	250 E	37205	253 E	37501	242 E	38060	268 E
35015	237 E	35514	241 E	37031	221 E	37210	252 E	37505	242 E	38063	268 E
35021	237 E	35515	241 E	37041	221 E	37211	252 E	37506	242 E	38065	268 E
35023	235 E	35516	241 E	37051	221 E	37212	252 E	37509	243 E	38089	268 E
35038	235 E	35517	241 E	37053	251 E	37216	261 E	37510	243 E	38095	267 E
35048	237 E	35518	241 E	37054	251 E	37217	261 E	37511	243 E	38096	267 E
35058	235 E	35519	241 E	37055	251 E	37218	261 E	37512	243 E	38097	267 E
35059	235 E	35524	241 E	37065	255 E	37220	252 E	37515	243 E	38895	256 E
35068	237 E	35525	241 E	37066	255 E	37229	262 E	37516	243 E	38896	256 E
35069	236 E	35527	241 E	37067	255 E	37230	262 E	37517	243 E	38899	256 E
35070	236 E	35532	241 E	37068	255 E	37231	262 E	37518	243 E	38900	256 E
35078	236 E	35533	241 E	37069	255 E	37232	262 E	37527	244 E	38901	256 E
35079	236 E	35539	241 E	37070	255 E	37233	262 E	37530	244 E	38902	256 E
35081	236 E	35540	241 E	37094	255 E	37234	262 E	37532	244 E	38903	256 E
35082	236 E	35542	241 E	37095	255 E	37235	262 E	37533	244 E	38904	256 E

REGISTER POLOŽIEK



číslo položky	str.	číslo položky	str.	číslo položky	str.	číslo položky	str.	číslo položky	str.	číslo položky	str.
38905	256 E	39145	267 E	42163	350 F	44950	150 D	45045	306 F	45131	317 F
38906	256 E	39165	267 E	42170	350 F	44950	302 F	45046	151 D	45132	317 F
38907	256 E	39190	267 E	42171	350 F	44955	304 F	45046	306 F	45133	318 F
38908	256 E	39192	267 E	42172	350 F	44960	309 F	45047	309 F	45134	315 F
38909	256 E	39192	309 F	42173	350 F	44965	330 F	45048	151 D	45135	317 F
38910	256 E	39193	267 E	42174	350 F	44970	298 F	45048	297 F	45136	318 F
38911	256 E	39193	309 F	42175	350 F	44971	298 F	45048	306 F	45137	318 F
38912	256 E	39194	268 E	42176	350 F	44972	294 F	45049	307 F	45138	316 F
38913	256 E	39195	268 E	42177	350 F	44980	294 F	45050	330 F	45139	316 F
38914	256 E	39196	268 E	42178	350 F	44980	294 F	45051	331 F	45140	315 F
38915	256 E	39197	268 E	42179	350 F	44980	296 F	45052	331 F	45141	316 F
38916	256 E	39198	268 E	42180	350 F	44981	294 F	45053	332 F	45142	315 F
38917	256 E	39199	268 E	42181	350 F	44981	294 F	45054	332 F	45143	316 F
38918	256 E	39200	268 E	42182	350 F	44981	295 F	45055	331 F	45144	317 F
38919	252 E	39201	268 E	42185	350 F	44981	296 F	45056	303 F	45145	317 F
38920	252 E	39202	268 E	42186	350 F	44982	295 F	45057	303 F	45146	319 F
38923	252 E	39203	268 E	42187	350 F	44982	295 F	45058	303 F	45147	320 F
38924	270 E	39204	268 E	42188	350 F	44982	296 F	45059	303 F	45150	320 F
38925	270 E	39205	268 E	42190	269 E	44983	295 F	45060	201 D	45151	321 F
38926	272 E	39206	259 E	42190	350 F	44983	295 F	45060	301 F	45152	319 F
38927	270 E	39207	259 E	42201	351 F	44983	295 F	45061	201 D	45153	319 F
38928	271 E	39210	259 E	42202	351 F	44983	296 F	45061	301 F	45154	319 F
38929	270 E	39212	259 E	42203	351 F	44984	296 F	45062	201 D	45155	320 F
38930	272 E	39214	259 E	42207	351 F	44984	297 F	45062	301 F	45156	320 F
38931	270 E	39216	259 E	42208	351 F	44984	297 F	45063	294 F	45158	320 F
38932	270 E	39217	259 E	42209	351 F	44985	296 F	45064	295 F	45159	321 F
38933	272 E	39218	259 E	42210	351 F	44985	297 F	45065	303 F	45160	320 F
38934	271 E	39219	259 E	42211	351 F	44986	296 F	45066	303 F	45161	321 F
38935	272 E	39234	259 E	42212	351 F	44987	296 F	45067	303 F	45162	319 F
38937	272 E	39238	259 E	42213	351 F	44988	296 F	45068	151 D	45163	320 F
38939	272 E	39245	259 E	42214	351 F	44989	296 F	45068	297 F	45164	321 F
38940	272 E	40050	349 F	42217	351 F	44991	296 F	45068	306 F	45167	320 F
38941	272 E	40051	349 F	42218	351 F	44992	296 F	45069	150 D	45168	321 F
38942	271 E	40052	349 F	42219	351 F	44995	300 F	45069	302 F	45169	321 F
38943	272 E	40053	349 F	42220	351 F	44996	296 F	45070	332 F	45170	323 F
38944	269 E	40054	349 F	42221	351 F	44997	297 F	45071	331 F	45171	323 F
38945	269 E	40055	349 F	42228	351 F	44998	297 F	45074	308 F	45172	323 F
38946	269 E	40056	349 F	42229	351 F	44999	299 F	45079	304 F	45172	323 F
38947	269 E	40057	349 F	42230	351 F	45000	299 F	45080	304 F	45173	323 F
38948	269 E	40058	349 F	42240	351 F	45001	299 F	45081	150 D	45173	323 F
38949	269 E	40059	349 F	42244	351 F	45002	300 F	45081	302 F	45174	323 F
38950	260 E	40060	349 F	42248	351 F	45003	300 F	45082	150 D	45175	322 F
38951	260 E	40075	349 F	42249	351 F	45005	300 F	45082	302 F	45176	322 F
38952	260 E	40076	349 F	42251	351 F	45006	300 F	45083	150 D	45177	322 F
38953	260 E	40100	349 F	42252	351 F	45007	300 F	45083	302 F	45178	322 F
38954	260 E	40120	349 F	42253	351 F	45008	300 F	45084	150 D	45179	321 F
38955	269 E	41050	349 F	42255	351 F	45009	300 F	45084	302 F	45180	315 F
38956	269 E	41080	349 F	42256	351 F	45010	297 F	45085	309 F	45181	315 F
38957	269 E	41081	349 F	42257	351 F	45011	299 F	45086	308 F	45182	322 F
38958	269 E	41082	349 F	42260	351 F	45012	299 F	45088	295 F	45183	322 F
38959	269 E	41083	349 F	42261	351 F	45014	297 F	45089	295 F	45184	321 F
38960	269 E	41100	349 F	42312	259 E	45015	299 F	45093	309 F	45185	321 F
38961	269 E	41101	349 F	42312	350 F	45016	298 F	45094	296 F	45186	321 F
38963	272 E	41102	349 F	42365	268 E	45017	296 F	45095	295 F	45187	322 F
38964	270 E	41103	349 F	42366	268 E	45018	297 F	45096	295 F	45190	324 F
38965	271 E	41120	349 F	42367	268 E	45019	298 F	45097	295 F	45191	324 F
38966	270 E	41121	349 F	42368	268 E	45020	294 F	45098	295 F	45192	324 F
38968	270 E	41122	349 F	42420	259 E	45021	298 F	45099	295 F	45193	324 F
38969	272 E	41123	349 F	43050	355 F	45023	294 F	45100	326 F	45194	324 F
38970	260 E	41150	349 F	43058	356 F	45025	298 F	45101	326 F	45195	324 F
38971	260 E	41151	349 F	43060	356 F	45026	297 F	45102	326 F	45196	324 F
38972	272 E	41152	349 F	43068	356 F	45027	298 F	45104	326 F	45197	324 F
38973	272 E	41153	349 F	43071	355 F	45029	298 F	45105	326 F	45198	324 F
38980	270 E	42101	349 F	43072	355 F	45030	201 D	45106	326 F	45199	324 F
38981	270 E	42102	349 F	43077	355 F	45030	301 F	45107	326 F	45200	324 F
38985	272 E	42103	349 F	43082	356 F	45031	201 D	45108	326 F	45203	325 F
38990	270 E	42110	259 E	43083	356 F	45031	301 F	45110	314 F	45204	325 F
38991	270 E	42112	259 E	43084	356 F	45032	201 D	45111	314 F	45206	324 F
38995	271 E	42113	259 E	43086	356 F	45032	301 F	45112	315 F	45211	325 F
39000	267 E	42115	262 E	43087	357 F	45033	201 D	45113	314 F	45213	317 F
39001	267 E	42120	262 E	43089	357 F	45033	301 F	45114	314 F	45214	319 F
39002	267 E	42150	350 F	43090	357 F	45034	304 F	45115	314 F	45215	318 F
39003	267 E	42151	350 F	43097	356 F	45035	303 F	45116	314 F	45216	319 F
39005	267 E	42152	350 F	43098	357 F	45036	307 F	45117	313 F	45217	319 F
39010	267 E	42153	350 F	43099	357 F	45038	304 F	45118	313 F	45218	318 F
39012	267 E	42155	350 F	43300	347 F	45039	304 F	45120	314 F	45219	318 F
39014	267 E	42156	350 F	43301	347 F	45040	304 F	45122	314 F	45220	325 F
39020	267 E	42157	350 F	44041	307 F	45041	304 F	45123	313 F	45221	325 F
39021	267 E	42158	350 F	44042	307 F	45042	309 F	45124	313 F	45222	325 F
39045	267 E	42160	350 F	44043	307 F	45043	306 F	45125	313 F	45223	325 F
39065	267 E	42161	350 F	44050	307 F	45044	307 F	45126	313 F	45224	325 F
39090	267 E	42162	350 F	44053	309 F	45045	151 D	45130	317 F	45225	325 F

číslo položky	str.	číslo položky	str.	číslo položky	str.	číslo položky	str.	číslo položky	str.	číslo položky	str.
45226	325 F	45392	311 F	45558	308 F	48022	120 C	50033	352 F	50907	369 G
45227	325 F	45393	311 F	45559	308 F	48030	120 C	50035	352 F	50909	369 G
45228	325 F	45394	311 F	45560	307 F	48031	121 C	50036	402 H	50910	369 G
45229	325 F	45395	311 F	45562	308 F	48032	121 C	50037	352 F	50911	369 G
45239	328 F	45396	311 F	45563	308 F	48033	121 C	50036	402 H	50915	369 G
45240	328 F	45397	311 F	45564	308 F	48034	121 C	50037	352 F	50916	369 G
45241	328 F	45398	312 F	45565	308 F	48036	119 C	50038	352 F	50917	369 G
45242	328 F	45399	312 F	45570	350 F	48037	120 C	50040	351 F	50918	369 G
45244	327 F	45400	312 F	45571	350 F	48040	121 C	50041	351 F	50919	369 G
45245	327 F	45401	312 F	45572	350 F	48041	121 C	50042	351 F	50920	369 G
45246	327 F	45410	354 F	45573	350 F	48042	121 C	50050	268 E	51001	368 G
45247	327 F	45415	354 F	45580	350 F	48043	121 C	50050	268 E	51002	368 G
45248	327 F	45420	354 F	45600	325 F	48046	120 C	50051	268 E	51003	368 G
45249	327 F	45425	354 F	45601	325 F	48046	121 C	50052	268 E	51004	368 G
45250	327 F	45426	354 F	45602	325 F	48047	120 C	50052	268 E	51007	368 G
45251	327 F	45427	354 F	45603	325 F	48047	121 C	50100	286 E	51008	367 G
45253	327 F	45450	354 F	45604	325 F	48050	122 C	50101	286 E	51009	368 G
45254	327 F	45451	354 F	45605	325 F	48051	122 C	50102	286 E	51010	368 G
45256	327 F	45452	354 F	45606	325 F	48054	122 C	50103	286 E	51011	368 G
45257	327 F	45453	354 F	45607	325 F	48055	122 C	50104	286 E	51013	367 G
45260	327 F	45460	354 F	45608	325 F	48056	122 C	50106	286 E	51015	368 G
45261	327 F	45461	354 F	45609	325 F	48057	122 C	50108	286 E	51017	367 G
45262	327 F	45462	354 F	45610	325 F	48060	122 C	50500	125 C	51018	367 G
45262	328 F	45463	354 F	45611	325 F	48061	122 C	50501	125 C	51020	367 G
45263	327 F	45465	354 F	45612	325 F	48062	122 C	50502	125 C	51022	367 G
45263	328 F	45466	354 F	45613	325 F	48063	122 C	50503	125 C	51023	367 G
45265	328 F	45467	354 F	45614	325 F	48064	122 C	50505	125 C	51026	366 G
45266	328 F	45470	354 F	45615	325 F	48065	122 C	50510	123 C	51030	367 G
45267	327 F	45471	272 E	45616	325 F	48066	122 C	50511	123 C	51034	367 G
45267	328 F	45471	306 F	45617	325 F	48067	122 C	50512	123 C	51036	368 G
45268	327 F	45471	370 G	45618	325 F	48068	122 C	50513	123 C	51037	368 G
45268	328 F	45472	306 F	45619	325 F	48070	122 C	50514	123 C	51038	368 G
45269	328 F	45473	306 F	45620	325 F	48071	122 C	50518	125 C	51040	366 G
45270	327 F	45480	354 F	45621	325 F	48072	122 C	50519	125 C	51041	366 G
45271	327 F	45485	354 F	45622	325 F	48075	122 C	50520	125 C	51042	366 G
45272	327 F	45490	342 F	45623	325 F	48076	122 C	50521	125 C	51043	366 G
45273	327 F	45496	354 F	45624	325 F	48077	122 C	50522	126 C	51045	367 G
45274	327 F	45497	354 F	45625	325 F	48080	122 C	50523	125 C	51046	367 G
45280	326 F	45498	354 F	45626	325 F	48081	122 C	50524	125 C	51050	369 G
45283	326 F	45499	354 F	45627	325 F	48085	122 C	50525	126 C	51051	369 G
45285	326 F	45500	305 F	45628	325 F	48086	122 C	50526	126 C	51055	369 G
45286	326 F	45502	305 F	45629	325 F	48087	122 C	50527	127 C	51056	369 G
45287	326 F	45503	305 F	45630	325 F	48090	122 C	50529	126 C	51057	369 G
45289	317 F	45505	305 F	45631	325 F	48091	122 C	50530	127 C	51060	366 G
45290	317 F	45506	305 F	45632	325 F	48093	122 C	50531	126 C	51065	366 G
45291	317 F	45508	305 F	45633	325 F	48094	122 C	50532	127 C	51070	366 G
45292	318 F	45509	305 F	45634	325 F	48095	122 C	50533	126 C	51071	366 G
45293	318 F	45511	305 F	45635	325 F	48096	122 C	50537	126 C	51072	366 G
45294	316 F	45512	305 F	45636	325 F	48097	122 C	50539	126 C	51100	288 E
45295	316 F	45513	305 F	45637	325 F	48410	290 E	50540	127 C	51101	288 E
45296	315 F	45515	305 F	45638	325 F	48411	290 E	50541	127 C	51102	288 E
45297	316 F	45516	305 F	45639	325 F	48415	290 E	50542	127 C	51103	288 E
45298	315 F	45517	305 F	45650	307 F	48420	290 E	50544	127 C	51104	288 E
45299	316 F	45518	305 F	45651	307 F	48452	290 E	50549	126 C	51105	288 E
45300	323 F	45519	305 F	45652	307 F	48453	290 E	50550	124 C	51106	288 E
45301	323 F	45520	305 F	45653	307 F	48454	290 E	50551	124 C	51107	288 E
45320	331 F	45521	305 F	45654	307 F	48455	290 E	50553	124 C	51108	288 E
45321	332 F	45522	305 F	45655	307 F	48456	290 E	50554	124 C	51109	288 E
45323	330 F	45523	305 F	45656	307 F	48457	290 E	50555	127 C	51110	288 E
45323	344 F	45524	305 F	45657	307 F	48719	246 E	50556	124 C	51111	288 E
45325	330 F	45525	305 F	45658	307 F	48729	245 E	50557	126 C	51120	288 E
45326	330 F	45526	305 F	45659	307 F	48730	245 E	50558	126 C	51121	288 E
45327	329 F	45527	305 F	45660	307 F	48731	245 E	50559	124 C	51122	288 E
45328	329 F	45528	305 F	45661	307 F	50004	374 G	50560	124 C	51123	288 E
45329	329 F	45529	305 F	45662	307 F	50005	374 G	50562	124 C	51124	288 E
45330	347 F	45530	305 F	45663	307 F	50009	375 G	50563	124 C	51125	288 E
45331	347 F	45531	305 F	45664	307 F	50010	375 G	50564	124 C	51126	288 E
45345	323 F	45532	305 F	45670	307 F	50011	375 G	50570	124 C	51127	288 E
45349	323 F	45533	305 F	45671	307 F	50012	375 G	50571	124 C	51130	288 E
45350	323 F	45534	305 F	45672	307 F	50013	375 G	50585	127 C	51131	288 E
45353	323 F	45535	308 F	45673	307 F	50014	375 G	50585	283 E	51132	288 E
45360	323 F	45540	308 F	48001	119 C	50015	375 G	50586	127 C	51181	375 G
45364	323 F	45541	308 F	48002	119 C	50017	377 G	50586	283 E	51182	375 G
45366	323 F	45542	308 F	48005	120 C	50019	377 G	50587	127 C	51186	369 G
45370	151 D	45543	308 F	48006	120 C	50020	377 G	50587	283 E	51187	369 G
45370	306 F	45550	308 F	48007	120 C	50021	377 G	50588	127 C	51196	288 E
45385	310 F	45551	308 F	48008	121 C	50022	377 G	50588	283 E	51197	288 E
45386	310 F	45552	308 F	48009	121 C	50025	377 G	50900	369 G	51198	288 E
45388	310 F	45553	308 F	48010	121 C	50026	377 G	50901	369 G	51199	288 E
45389	310 F	45555	308 F	48015	119 C	50030	352 F	50902	369 G	51200	369 G
45390	311 F	45556	308 F	48020	120 C	50031	352 F	50905	369 G	51201	369 G
45391	311 F	45557	308 F	48021	120 C	50032	352 F	50906	369 G	51202	369 G

REGISTER POLOŽIEK



číslo položky	str.	číslo položky	str.	číslo položky	str.	číslo položky	str.	číslo položky	str.	číslo položky	str.
51203	369 G	51420	287 E	52215	278 E	55350	117 C	61020	336 F	61164	339 F
51204	286 E	51430	287 E	52216	278 E	55351	117 C	61021	335 F	61165	339 F
51205	286 E	51431	287 E	52217	278 E	55352	117 C	61022	336 F	61166	339 F
51206	286 E	51432	287 E	52218	278 E	55353	117 C	61024	337 F	61169	233 E
51207	286 E	51433	287 E	52220	278 E	55354	117 C	61025	335 F	61171	347 F
51208	286 E	51435	287 E	52283	278 E	55355	117 C	61026	335 F	61172	344 F
51209	286 E	51436	287 E	52284	278 E	55356	117 C	61028	339 F	61172	347 F
51210	286 E	51450	287 E	52285	278 E	55357	117 C	61029	335 F	61173	347 F
51211	286 E	51500	363 G	52286	278 E	55358	117 C	61030	333 F	61174	347 F
51212	286 E	51510	363 G	52288	278 E	55359	117 C	61031	333 F	61175	347 F
51220	287 E	51511	363 G	52305	281 E	55360	117 C	61032	333 F	61176	347 F
51221	287 E	51512	363 G	52306	281 E	55361	117 C	61033	333 F	61177	347 F
51222	287 E	51513	363 G	52315	281 E	55362	117 C	61034	333 F	61183	348 F
51225	287 E	51514	363 G	52328	281 E	55400	353 F	61035	340 F	61184	348 F
51226	287 E	51515	363 G	52331	281 E	55401	353 F	61036	340 F	61189	348 F
51227	287 E	51516	363 G	52334	281 E	55402	353 F	61038	340 F	61190	348 F
51241	286 E	51517	363 G	52391	281 E	55403	353 F	61040	340 F	61192	347 F
51242	286 E	52010	376 G	52421	281 E	55404	353 F	61042	340 F	61193	347 F
51243	286 E	52012	376 G	52424	281 E	55405	353 F	61044	339 F	61194	347 F
51244	286 E	52020	376 G	52428	281 E	55406	353 F	61045	333 F	61195	348 F
51245	286 E	52030	226 E	52456	281 E	55420	353 F	61046	333 F	61200	347 F
51246	286 E	52030	376 G	52471	282 E	55421	353 F	61047	333 F	61201	347 F
51247	286 E	52050	290 E	52600	280 E	55422	353 F	61048	333 F	61201	347 F
51257	288 E	52055	290 E	52601	282 E	55423	353 F	61050	336 F	61202	348 F
51258	288 E	52060	290 E	52602	280 E	55424	353 F	61051	336 F	61203	339 F
51259	288 E	52065	290 E	52605	280 E	55425	353 F	61052	337 F	61204	348 F
51260	288 E	52070	278 E	52610	280 E	55429	353 F	61053	336 F	61205	348 F
51261	288 E	52071	279 E	52620	283 E	55430	353 F	61054	337 F	61206	348 F
51262	288 E	52075	279 E	52625	283 E	55431	353 F	61056	335 F	61207	348 F
51263	288 E	52076	279 E	52630	283 E	55432	353 F	61057	335 F	61208	348 F
51264	288 E	52077	279 E	52635	283 E	55433	353 F	61058	337 F	61209	339 F
51265	288 E	52078	279 E	52640	283 E	55436	353 F	61059	337 F	61215	348 F
51271	286 E	52101	344 F	52645	283 E	55437	353 F	61060	333 F	61218	233 E
51272	286 E	52102	344 F	52652	283 E	55450	352 F	61061	333 F	61219	348 F
51273	286 E	52103	344 F	52656	283 E	55452	353 F	61062	333 F	61221	341 F
51274	286 E	52104	344 F	52662	282 E	55453	353 F	61063	333 F	61221	341 F
51275	286 E	52105	344 F	52666	282 E	55454	353 F	61067	341 F	61221	341 F
51276	286 E	52108	344 F	52671	282 E	55455	353 F	61068	341 F	61221	341 F
51278	286 E	52109	345 F	52694	282 E	55456	353 F	61069	341 F	61222	339 F
51280	287 E	52110	374 G	52695	282 E	55457	353 F	61070	341 F	61223	338 F
51281	287 E	52111	374 G	54008	283 E	55460	353 F	61077	342 F	61224	340 F
51282	287 E	52113	345 F	55040	117 C	55461	353 F	61079	342 F	61224	340 F
51283	287 E	52114	345 F	55041	117 C	55462	353 F	61085	304 F	61230	348 F
51284	287 E	52115	345 F	55050	117 C	55640	291 E	61088	336 F	61235	376 G
51286	287 E	52116	345 F	55051	117 C	55642	291 E	61089	335 F	61236	376 G
51287	287 E	52119	343 F	55060	117 C	55645	291 E	61090	336 F	61240	92 C
51288	287 E	52125	347 F	55080	117 C	60001	346 F	61097	338 F	61250	348 F
51300	286 E	52126	347 F	55100	117 C	60006	346 F	61098	338 F	61251	309 F
51301	286 E	52130	252 E	55101	117 C	60008	346 F	61111	340 F	61251	348 F
51302	286 E	52160	344 F	55120	117 C	60012	346 F	61112	340 F	61252	348 F
51303	286 E	52161	344 F	55121	117 C	60018	347 F	61114	340 F	61253	348 F
51304	286 E	52162	344 F	55140	117 C	60019	347 F	61120	340 F	61254	348 F
51305	286 E	52163	344 F	55141	117 C	60020	347 F	61121	340 F	61255	348 F
51306	286 E	52164	344 F	55160	117 C	60022	347 F	61130	331 F	61256	348 F
51307	286 E	52168	343 F	55180	117 C	60100	233 E	61131	331 F	61290	341 F
51308	286 E	52173	343 F	55181	117 C	60115	245 E	61132	331 F	61291	341 F
51320	286 E	52175	343 F	55200	117 C	60116	245 E	61133	331 F	61292	341 F
51321	286 E	52176	343 F	55201	117 C	60117	245 E	61134	332 F	61293	341 F
51322	286 E	52185	344 F	55220	117 C	60118	245 E	61135	332 F	61294	341 F
51323	286 E	52186	344 F	55221	117 C	60121	245 E	61136	329 F	61295	341 F
51324	286 E	52187	344 F	55240	117 C	60123	245 E	61137	329 F	61296	341 F
51325	286 E	52188	344 F	55300	117 C	60201	346 F	61138	329 F	61297	341 F
51327	286 E	52189	344 F	55301	117 C	60206	346 F	61139	330 F	61299	352 F
51338	288 E	52190	344 F	55311	117 C	60208	346 F	61140	330 F	61300	352 F
51340	288 E	52191	344 F	55313	117 C	60212	346 F	61141	332 F	61301	352 F
51341	288 E	52192	344 F	55314	117 C	61000	336 F	61142	332 F	61302	352 F
51348	288 E	52193	344 F	55315	117 C	61001	336 F	61143	333 F	61320	92 C
51402	287 E	52194	344 F	55316	117 C	61002	337 F	61144	333 F	61321	92 C
51403	287 E	52195	345 F	55317	117 C	61003	338 F	61145	333 F	61322	92 C
51404	287 E	52196	345 F	55318	117 C	61004	337 F	61146	333 F	61323	92 C
51405	287 E	52197	344 F	55319	117 C	61005	334 F	61147	329 F	61324	92 C
51406	287 E	52198	343 F	55331	117 C	61006	334 F	61148	329 F	61325	92 C
51407	287 E	52202	278 E	55332	117 C	61007	335 F	61149	330 F	61326	92 C
51408	287 E	52203	278 E	55333	117 C	61008	334 F	61149	344 F	61327	92 C
51410	287 E	52204	278 E	55334	117 C	61009	339 F	61150	331 F	61328	92 C
51412	287 E	52205	278 E	55335	117 C	61010	335 F	61155	334 F	61329	92 C
51413	287 E	52206	278 E	55336	117 C	61012	339 F	61156	334 F	61330	92 C
51414	287 E	52207	278 E	55337	117 C	61013	338 F	61157	334 F	61331	92 C
51415	287 E	52208	278 E	55339	117 C	61014	339 F	61158	334 F	61340	95 C
51416	287 E	52212	278 E	55340	117 C	61015	335 F	61161	337 F	61341	95 C
51417	287 E	52213	278 E	55341	117 C	61018	338 F	61162	338 F	61342	95 C
51418	287 E	52214	278 E	55342	117 C	61019	338 F	61163	338 F	61343	95 C

číslo položky	str.	číslo položky	str.	číslo položky	str.	číslo položky	str.	číslo položky	str.	číslo položky	str.
61344	95 C	70221	374 G	81231	383 G	81314	383 G	81398	383 G	89973	277 E
61345	95 C	81011	382 G	81232	383 G	81315	383 G	81399	383 G	89973	371 G
61346	95 C	81012	382 G	81233	383 G	81316	383 G	81400	383 G	89975	277 E
65062	291 E	81013	382 G	81234	383 G	81317	383 G	81401	383 G	89975	371 G
65063	291 E	81014	382 G	81235	383 G	81318	383 G	81402	383 G	89980	277 E
65064	291 E	81015	382 G	81236	383 G	81319	383 G	81403	383 G	89980	371 G
65065	291 E	81016	382 G	81237	383 G	81320	383 G	81404	383 G	89985	277 E
69900	264 E	81022	382 G	81238	383 G	81321	383 G	81405	383 G	89985	371 G
69901	264 E	81023	382 G	81239	383 G	81322	383 G	81406	383 G	89987	277 E
69902	264 E	81024	382 G	81240	383 G	81323	383 G	81407	383 G	89987	371 G
69903	264 E	81025	382 G	81241	383 G	81324	383 G	81408	383 G	89988	277 E
69904	263 E	81035	382 G	81242	383 G	81325	383 G	81409	383 G	89988	371 G
69905	264 E	81036	382 G	81243	383 G	81326	383 G	81410	383 G	89989	277 E
69906	264 E	81053	380 G	81244	383 G	81327	383 G	81411	383 G	89989	371 G
69907	266 E	81054	380 G	81245	383 G	81328	383 G	81412	383 G	89990	277 E
69908	266 E	81055	380 G	81246	383 G	81329	383 G	81413	383 G	89990	371 G
69909	266 E	81056	380 G	81247	383 G	81330	383 G	81414	383 G	90070	250 E
69910	265 E	81057	380 G	81248	383 G	81331	383 G	81415	383 G	90071	250 E
69911	265 E	81070	380 G	81249	383 G	81332	383 G	81416	383 G	90072	250 E
69912	265 E	81071	380 G	81250	383 G	81333	383 G	81417	383 G		
69914	264 E	81072	380 G	81251	383 G	81334	383 G	81418	383 G		
69917	265 E	81073	380 G	81252	383 G	81335	383 G	81419	383 G		
69918	263 E	81074	380 G	81253	383 G	81336	383 G	81420	383 G		
69919	263 E	81075	380 G	81254	383 G	81337	383 G	81421	383 G		
69920	266 E	81076	380 G	81255	383 G	81338	383 G	81422	383 G		
69923	266 E	81077	380 G	81256	383 G	81339	383 G	81423	383 G		
69928	266 E	81100	380 G	81257	383 G	81340	383 G	81424	383 G		
69930	265 E	81101	380 G	81258	383 G	81341	383 G	81425	383 G		
69931	265 E	81102	380 G	81259	383 G	81342	383 G	81426	383 G		
70020	114 C	81103	380 G	81260	383 G	81343	383 G	81427	383 G		
70021	114 C	81104	380 G	81261	383 G	81344	383 G	81428	383 G		
70025	114 C	81105	380 G	81262	383 G	81345	383 G	81429	383 G		
70026	114 C	81106	380 G	81263	383 G	81346	383 G	81430	383 G		
70030	114 C	81113	380 G	81264	383 G	81347	383 G	81431	383 G		
70031	114 C	81114	380 G	81265	383 G	81348	383 G	81432	383 G		
70032	114 C	81115	380 G	81266	383 G	81349	383 G	81433	383 G		
70033	114 C	81150	384 G	81267	383 G	81350	383 G	81434	383 G		
70035	114 C	81151	384 G	81268	383 G	81351	383 G	81435	383 G		
70036	114 C	81152	384 G	81269	383 G	81352	383 G	81436	383 G		
70037	114 C	81155	384 G	81270	383 G	81353	383 G	81437	383 G		
70038	114 C	81160	385 G	81271	383 G	81354	383 G	81438	383 G		
70040	114 C	81165	385 G	81272	383 G	81355	383 G	81439	383 G		
70045	114 C	81170	384 G	81273	383 G	81356	383 G	81440	383 G		
70046	114 C	81175	385 G	81274	383 G	81357	383 G	81441	383 G		
70060	115 C	81178	385 G	81275	383 G	81358	383 G	81442	383 G		
70061	115 C	81180	385 G	81276	383 G	81359	383 G	81443	383 G		
70062	115 C	81185	384 G	81277	383 G	81360	383 G	81444	383 G		
70063	115 C	81186	384 G	81278	383 G	81361	383 G	81445	383 G		
70064	115 C	81189	384 G	81279	383 G	81362	383 G	81447	383 G		
70065	116 C	81190	385 G	81280	383 G	81363	383 G	81448	383 G		
70066	115 C	81191	385 G	81281	383 G	81364	383 G	81449	383 G		
70070	116 C	81200	383 G	81282	383 G	81365	383 G	81450	383 G		
70075	116 C	81201	383 G	81284	383 G	81366	383 G	81451	383 G		
70090	116 C	81202	383 G	81285	383 G	81367	383 G	81452	383 G		
70091	116 C	81203	383 G	81286	383 G	81370	383 G	81453	383 G		
70092	116 C	81204	383 G	81287	383 G	81371	383 G	81454	383 G		
70093	116 C	81205	383 G	81288	383 G	81372	383 G	81455	383 G		
70094	116 C	81206	383 G	81289	383 G	81373	383 G	81456	383 G		
70095	116 C	81207	383 G	81290	383 G	81374	383 G	81457	383 G		
70096	116 C	81208	383 G	81291	383 G	81375	383 G	81458	383 G		
70098	70 C	81209	383 G	81292	383 G	81376	383 G	81459	383 G		
70100	365 G	81210	383 G	81293	383 G	81377	383 G	81460	383 G		
70101	365 G	81211	383 G	81294	383 G	81378	383 G	81461	383 G		
70102	365 G	81212	383 G	81295	383 G	81379	383 G	81462	383 G		
70103	365 G	81213	383 G	81296	383 G	81380	383 G	81463	383 G		
70104	365 G	81214	383 G	81297	383 G	81381	383 G	81466	383 G		
70105	365 G	81215	383 G	81298	383 G	81382	383 G	81467	383 G		
70106	365 G	81216	383 G	81299	383 G	81383	383 G	81468	383 G		
70107	365 G	81217	383 G	81300	383 G	81384	383 G	81469	383 G		
70108	365 G	81218	383 G	81301	383 G	81385	383 G	81470	383 G		
70109	365 G	81219	383 G	81302	383 G	81386	383 G	81471	383 G		
70110	365 G	81220	383 G	81303	383 G	81387	383 G	81472	383 G		
70114	364 G	81221	383 G	81304	383 G	81388	383 G	81473	383 G		
70120	364 G	81222	383 G	81305	383 G	81389	383 G	81486	383 G		
70121	364 G	81223	383 G	81306	383 G	81390	383 G	81600	381 G		
70122	364 G	81224	383 G	81307	383 G	81391	383 G	81603	381 G		
70123	364 G	81225	383 G	81308	383 G	81392	383 G	82101	262 E		
70124	364 G	81226	383 G	81309	383 G	81393	383 G	82104	262 E		
70125	364 G	81227	383 G	81310	383 G	81394	383 G	82105	262 E		
70140	364 G	81228	383 G	81311	383 G	81395	383 G	82109	262 E		
70141	364 G	81229	383 G	81312	383 G	81396	383 G	89970	277 E		
70220	374 G	81230	383 G	81313	383 G	81397	383 G	89970	371 G		

GRAFICKÉ SYMBOLY POUŽITÉ V KATALÔGU

· ŠPECIFIKÁCIA PRODUKTOV ·



ŠPECIFIKÁCIA POUŽITIA

- drevo ·
- keramika ·
- plasty ·
- hliník ·
- meď ·
- kameň ·
- sklo ·
- murivo ·
- papier ·
- ocel ·
- kompozit ·
- obklady ·
- nerezová oceľ ·
- omietka ·
- drevo so skrutkami, klincami ·
- sadrokartón ·
- pre vŕtanie do materiálov s pevnosťou v ťahu do ... ·

- S2** · funkčné časti z vysoko legovanej nástrojovej ocele S2
- HSS** · funkčné časti vyrobené z rýchloreznej ocele
- Cr-Mo** · funkčné časti z chróm-molybdénovej ocele
- CrV** · funkčné časti z chróm-vanádiovej ocele
- INOX** · funkčné časti z nehrzdavejúcej ocele
- NYLON** · nylonová rukoväť
- TEFLON** · teflónový povrch
- Zn** · zinkované
- TiN** · povrch potiahnutý nitridom titánu
- HRC 58-61** · tvrdosť materiálu funkčných častí podľa Rockwella
- 40% PES** · zloženie materiálu - obsahuje 40% polyesteru
- PES** · zloženie materiálu - vyrobené z polyesteru
- diamantové zrná na povrchu funkčných častí
- magnetické

- SDS+** **SDS MAX** **M14** · spôsob uchytenia
- 72T** **36T** · počet zubov račne
- 1/2"** **3/4"** **1/4"** · veľkosť uchytenia
- 27 dB** · údaj o výške ochrany sluchu
- DIN 3113** **IP 54** · spĺňa uvedenú normu
- 32x** · počet produktov v sade
- II. class** **III. class** · spĺňa uvedenú triedu presnosti
- vhodné do chladného počasia
- ERGO HANDLE** · ergonomická rukoväť
- HOBBY** · pre hobby použitie
- 2x AAA** · počet a typ batérií
- UV STABLE** · odolné proti UV žiareniu
- RUBBER ENDS** · nárazuvzdorné gumené koncovky

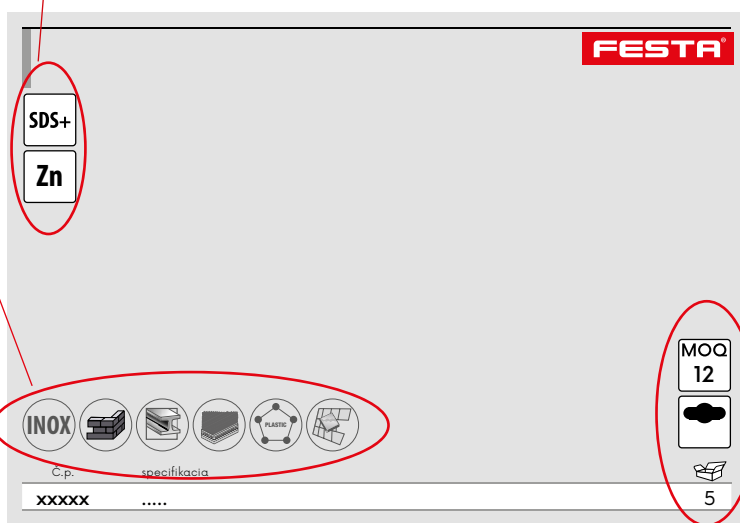

· ŠPECIFIKÁCIA BALENIA

- balené v krabici
- balenie so závesom
- MOQ 12** · minimálne objednávatel'né množstvo
- 5** · počet kusov v balení

· ŠPECIFIKÁCIA PRODUKTOV VODNÉHO PROGRAMU ·

voliteľný tvar prúdu vody ·

minimálny a maximálny tlak ·

maximálny prietok vody ·

zavlažovaná plocha ·

veľkosť závitú pre pripojenie adaptéra ·

priemer hadice pre pripojenie do rýchlospojky ·

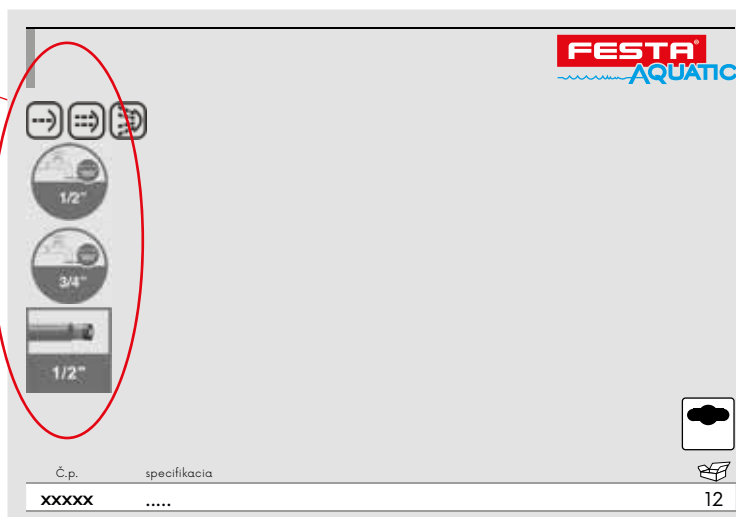

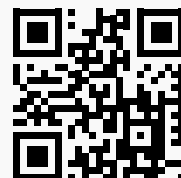

2022



PROFESIONÁLNE X NÁRADIE

www.festa.tools

HORIZONT

FESTA
AQUATIC



ROSA

KOMELON

KDS

Stahlberg

SUPER PRO

Lescha



WINLAND