

FESTA®

PROFESIONÁLNÍ  NÁŘADÍ

2022



FESTA[®]

Značka kvalitního ručního nářadí pro stavbu dílny i zahrady

HORIZONT
EXACTA

Značka profesionálních vodováh

HORIZONT

Značka profesionálních vodováh a kvalitních latí

FESTA
AQUATIC

Profesionální zavlažovací sortiment s moderním designem, kompatibilní s řadou produktů Rosa

ROSA

Kvalitního zavlažovací systémy a zahradní nářadí

KDS[®]

Japonské nože s dlouholetou tradicí

KOMELON[®]

Profesionální měřidla



Profesionální řezačky obkladů



Výrobce kvalitních zahradních nůžek

Lescha

Profesionální stavební míchačky

Stahlberg

Profesionální šroubovací nástavce



Značka profesionálních pil

MĚŘIDLA, ZNAČKOVAČE

2 - 37



4 6 9 10 12 13 15 20 21 23 32 36

DÍLENSKÉ NÁŘADÍ

38 - 133



40 48 51 65 78 89 95 101 107 110 114 118 123 129

ŘEZNÉ A BRUSNÉ NÁSTROJE

134 - 209



136 147 152 155 157 166 170 176 179 183 188 191 197 203

STAVEBNÍ NÁŘADÍ

210 - 291



212 222 227 233 240 247 253 263 267 269 273 284 289 290

ZAHRADNÍ NÁŘADÍ

292 - 257



294 305 307 308 310 326 327 329 334 343 349 350 354 355

ŽELEZÁŘSKÉ ZBOŽÍ

358 - 391



360 364 366 369 371 372 373 375 377 378 380 386

AUTODOPLŇKY

391 - 403



394 395 396 398 399 400 400 401 401 402 403

REJSTRÍK

404 - 416



MĚŘIDLA A ZNAČKOVAČE 2 - 37



4

SVINOVACÍ METRY A PÁSMA KOMELON



6

SVINOVACÍ METRY FESTA



9

PÁSMA



10

SKLÁDACÍ METRY



12

POSUVNÁ MĚŘIDLA



13

PRAVÍTKA A ÚHELNÍKY



15

VODOVÁHY A LATĚ HORIZONT



20

VODOVÁHY NIVELA



21

DIGITÁLNÍ VODOVÁHY A ÚHLOMĚRY



23

LASERLINER



32

TUŽKY A ZNAČKOVAČE



36

SPREJE



· VYSOCE PŘESNÁ A KVALITNÍ MĚŘIDLA

KOMELON®

- II. třída přesnosti dle ČSN 251104, EEC 755345
- nylonový povrch pásku DURA NY Coat™ zaručuje desetinásobně vyšší odolnost proti otěru stupnice

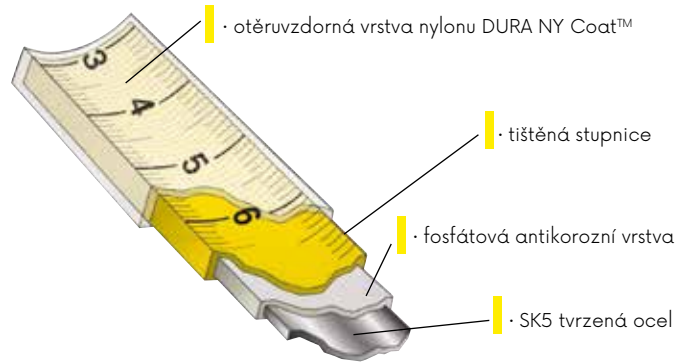

METR SVINOVACÍ

KOMELON®



· Otěruvzdorná vrstva nylonu DURA NY Coat™



Č.p.	specifikace	
10002	2 m · 16 mm	10
10003	3 m · 16 mm	10
10005	5 m · 19 mm	10
10008	8 m · 25 mm	10

METR SVINOVACÍ

KOMELON®



· Otěruvzdorná vrstva nylonu DURA NY Coat™



Č.p.	specifikace	
10025	5 m · 25 mm	10

METR SVINOVACÍ

KOMELON®



· Otěruvzdorná vrstva nylonu DURA NY Coat™



- automatická brzda
- protiskluzové pogumování

Č.p.	specifikace	
10033	3 m · 16 mm	6
10035	5 m · 19 mm	6

METR SVINOVACÍ

KOMELON®



Č.p.	specifikace	
10043	3 m · 16 mm	30
10045	5 m · 19 mm	30
10048	8 m · 25 mm	12

PÁSMO OCELOVÉ

KOMELON®

II. class

Č.p.	specifikace	
10110	10 m · 10 mm	6
10120	20 m · 10 mm	6
10130	30 m · 10 mm	6

PÁSMO SKLOLAMINÁTOVÉ

KOMELON®

II. class

Č.p.	specifikace	
10330	10 m · 13 mm	6
10332	20 m · 13 mm	6
10334	30 m · 13 mm	6
10336	50 m · 13 mm	6

PÁSMO SKLOLAMINÁTOVÉ

KOMELON®

II. class

Č.p.	specifikace	
10430	30 m · 13 mm	1
10450	50 m · 13 mm	1
10490	100 m · 13 mm	1

STOJAN NA METRY

KOMELON®

· osazení stojanu 10996

- 10003 · 5 ks
- 10005 · 4 ks
- 10008 · 1 ks
- 10033 · 2 ks
- 10035 · 3 ks
- 10045 · 2 ks
- 10025 · 3 ks
- 10110 · 1 ks
- 10120 · 1 ks
- 10130 · 1 ks
- 10430 · 1 ks
- 10330 · 1 ks
- 10332 · 1 ks
- 10334 · 1 ks
- 10336 · 1 ks



· ilustrační foto

STOJAN NA METRY



· ilustrační foto

Č.p.	specifikace	
10999	stojan na metry	1
10996	stojan na metry osazený	1



· Informace o pásce metru



- A** 15m · délka metru
- B** II · třída přesnosti
- C** CE · prohlášení o shodě - CE
- D** M17 · rok výroby
- E** 0071 · číslo akreditované zkušebny vydávající certifikát
- F** 9 · výrobce
- G** 12 · speciální úprava pásky
- H** 29°C · teplota, při které byla zkouška prováděna

Č.p.	specifikace	
10998		1

FESTA



METR SVINOVACÍ

FESTA



- stupnice s velkými číslicemi
- protiskuzové pogumování
- nylonová vrstva



Č.p.	specifikace	
11353	3 m · 19 mm	1
11355	5 m · 19 mm	1
11356	5 m · 25 mm	1
11358	8 m · 25 mm	1
11360	10 m · 25 mm	1

METR SVINOVACÍ

FESTA



- protiskuzové pogumování PTE

- poutko



- automatická brzda

- pochromovaný, kovový klip

- ABS pouzdro

- nylonová vrstva



Č.p.	specifikace	
11343	3 m · 16 mm	6
11345	5 m · 19 mm	6
11347	7,5 m · 25 mm	6

METR SVINOVACÍ - MAGNET

FESTA



- 3 x brzda
- magnetický háček
- přibrždování
- protiskuzové pogumování



Č.p.	specifikace	
11323	3 m · 16 mm	10
11325	5 m · 19 mm	8
11327	7,5 m · 25 mm	6

METR SVINOVACÍ COMPACT

FESTA



- malý rozměr metru
- nylonová vrstva



Č.p.	specifikace	
11220	3 m · 16 mm	12
11221	5 m · 19 mm	12

METR SVINOVACÍ

FESTA



- stupnice s velkými číslicemi



Č.p.	specifikace	
11226	2 m · 16 mm	10
11239	3 m · 19 mm	10
11259	5 m · 19 mm	10
11260	7,5 m · 25 mm	10

METR SVINOVACÍ - MAGNETIC

FESTA



- magnetický háček
- protiskuzové pogumování
- fluorescenční páska
- stupnice s velkými číslicemi



Č.p.	specifikace	
11102	2 m · 16 mm	10
11103	3 m · 16 mm	10
11105	5 m · 19 mm	10
11106	5 m · 25 mm	10
11107	7,5 m · 25 mm	10
11110	10 m · 25 mm	10

METR SVINOVACÍ

FESTA



- automatická brzda
- protiskuzové pogumování



Č.p.	specifikace	
11333	3 m · 16 mm	12
11335	5 m · 19 mm	12
11337	7,5 m · 25 mm	12
11338	10 m · 25 mm	12

METR SVINOVACÍ

Johnney®



- matná úprava pásky



Č.p.	specifikace	
11002	2 m · 13 mm	12
11003	3 m · 13 mm	12
11005	5 m · 13 mm	12
11006	5 m · 19 mm	12
11007	7,5 m · 19 mm	12
11008	10 m · 25 mm	12

METR SVINOVACÍ - ERGO



- přibrzdňování
- protiskuzové pogumování



Č.p.	specifikace	
11082	2 m · 16 mm	12
11083	3 m · 16 mm	12
11085	5 m · 19 mm	12

METR SVINOVACÍ



- metrická a palcová stupnice
- protiskuzové pogumování



Č.p.	specifikace	
11416	5 m · 19 mm	10

METR SVINOVACÍ



- přibrzdňování



Č.p.	specifikace	
11200	2 m · 13 mm	24
11201	2 m · 16 mm	24
11202	2 m · 19 mm	24
11204	3 m · 13 mm	24
11205	3 m · 16 mm	24
11206	3 m · 19 mm	24
11207	5 m · 19 mm	12
11208	5 m · 25 mm	12
11209	7,5 m · 25 mm	12
11210	10 m · 25 mm	12

PÁSKA KOVOVÁ, MĚŘICÍ, PLOCHÁ, SAMOLEPICÍ

II. class



Č.p.	specifikace	
11311	1 m · 12,5 mm	30
11312	2 m · 12,5 mm	30
11313	3 m · 16 mm	30
11314	5 m · 19 mm	30



METR SVINOVACÍ SE JMÉNEM, 3M · 16 MM

CE

II. class



Č.p.	jméno na metru	Č.p.	jméno na metru	Č.p.	jméno na metru
13500	JIŘÍ	13512	MICHAL	13524	ROMAN
13501	PETR	13513	MILAN	13525	ŠIKULA
13502	JOSEF	13514	KAREL	13526	RADEK
13503	TOMÁŠ	13515	VLADIMÍR	13527	MISTR
13504	JAN	13516	DĚDEČEK	13528	ONDŘEJ
13505	MARTIN	13517	MŮJ METR	13529	MAREK
13506	JAROSLAV	13518	VÁCLAV	13530	STANISLAV
13507	FRANTIŠEK	13519	JAKUB	13531	BOREC
13508	PAVEL	13520	LUKÁŠ	13532	TATÍNEK
13509	MIROSLAV	13521	2X MĚŘ	13533	ANTONÍN
13510	BIG BOSS	13522	LADISLAV	13534	ALEŠ
13511	ZDENĚK	13523	DAVID		



10

METR SVINOVACÍ - PŘÍVĚSEK

II. class



- stupnice s velkými číslicemi
- vlastnosti plnohodnotného metru

MOQ 12

Č.p.	specifikace	
11410	2 m · 16 mm 6 barev	12

METR SVINOVACÍ - PŘÍVĚSEK



Č.p.	specifikace	
11420	1 m · 6 mm oranžový	24

METR SVINOVACÍ - PŘÍVĚSEK



Č.p.	specifikace	
11444	1 m · 6 mm bílý	24

METR SVINOVACÍ - PŘÍVĚSEK



Č.p.	specifikace	
11425	1 m · 6 mm	50

LIBELA - PŘÍVĚSEK



Č.p.	specifikace	
11445		100

PÁSMO OCELOVÉ

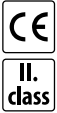

· očko

Č.p.	specifikace	
12010	10 m · 10 mm	1
12020	20 m · 10 mm	1
12030	30 m · 10 mm	1
12050	50 m · 10 mm	6

PÁSMO SKLOLAMINÁTOVÉ



· očko

Č.p.	specifikace	
12110	10 m · 13 mm	6
12120	20 m · 13 mm	1
12130	30 m · 13 mm	1
12150	50 m · 13 mm	1

PÁSMO OCELOVÉ



· očko + háček

Č.p.	specifikace	
12210	10 m · 10 mm	6
12220	20 m · 10 mm	6
12230	30 m · 10 mm	6
12250	50 m · 10 mm	6

PÁSMO OCELOVÉ



· očko

Č.p.	specifikace	
12433	30 m · 12,5 mm	20
12435	50 m · 12,5 mm	10

TYČ MĚŘICÍ TELESKOPICKÁ



· včetně pouzdra

Č.p.	specifikace	
15983	0,7 - 3 m	10
15985	1,1 - 5 m	10
15988	1,6 - 8 m	5

KOLEČKO MĚŘICÍ



- odolné, lehké a kompaktní
- počítadlo přičítá při pohybu vpřed a odečítá při pohybu vzad
- vestavěné osvětlení pro noční práci, 2 baterie AAA v rukojeti



Č.p.	specifikace	
15989	max. 10 km	2

METR SKLÁDACÍ

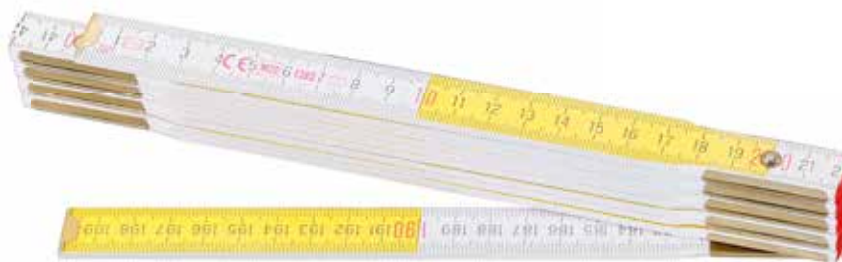
III.
class

Č.p.	specifikace	
13010	1 m · bílý	20
13020	2 m · bílý	10
13021	1 m · žlutý	20
13022	2 m · žlutý	10
13023	2 m · bílo - žlutý	10
13030	3 m · bílý	10

METR SKLÁDACÍ



Č.p.	specifikace	
13111	1 m · žlutý	10
13120	2 m · žlutý	5

METR SKLÁDACÍ



Č.p.	specifikace	
13210	1 m · mini	10
13211	1 m	1
13220	2 m	1

MĚŘÍTKO S RUKOJETÍ

FESTA

ALU



· 2 x libela

Č.p.	specifikace	
14030	600 mm	6

MĚŘÍTKO OCELOVÉ

FESTA

INOX



Č.p.	specifikace	
14010	300 mm	10
14011	600 mm	20
14012	1000 mm	20

MĚŘÍTKO HLINÍKOVÉ

FESTA

ALU



Č.p.	specifikace	
14015	400 mm	48
14017	600 mm	50
14019	1000 mm	40

MĚŘÍTKO VÍCEÚČELOVÉ



Č.p.	specifikace	
14480	250 x 120 mm	1



METR SKLÁDACÍ SE JMÉNEM



10

Č.p.	jméno na metru	Č.p.	jméno na metru	Č.p.	jméno na metru
13401	JIŘÍ	13425	RADEK	13449	VOJTĚCH
13402	JAN	13426	DANIEL	13450	ZDENKO
13403	PETR	13427	ANTONÍN	13451	JANA
13404	JOSEF	13428	VOJTĚCH	13452	EVA
13405	PAVEL	13429	FILIP	13453	PETRA
13406	MARTIN	13430	ADAM	13454	MAJKA
13407	JAROSLAV	13431	MILOSLAV	13455	HANA
13408	TOMÁŠ	13432	MATĚJ	13456	ANNA
13409	MIROSLAV	13433	ALEŠ	13457	LENKA
13410	ZDENĚK	13434	JAROMÍR	13458	KATKA
13411	FRANTIŠEK	13435	LIBOR	13459	LUCIE
13412	VÁCLAV	13436	DOMINIK	13460	ALENA
13413	MICHAL	13437	PATRIK	13461	VERONIKA
13414	MILAN	13438	VLASTIMIL	13462	MARTINA
13415	KAREL	13439	JINDŘICH	13463	JITKA
13416	JAKUB	13440	MILOŠ	13464	BIG BOSS
13417	DAVID	13441	JÁN	13465	2 x MĚŘ
13418	LUKÁŠ	13442	PETER	13466	TATÍNEK
13419	VLADIMÍR	13443	ONDREJ	13467	DĚDEČEK
13420	LADISLAV	13444	JOZEF	13468	ŠIKULA
13421	ONDŘEJ	13445	PAVOL	13469	MISTR
13422	ROMAN	13446	L'UBOMÍR	13470	MACHR
13423	STANISLAV	13447	KAROL	13471	BOREC
13424	MAREK	13448	RADOSLAV	13472	UŽ JE MŮJ
				13473	MŮJ METR

STOJAN NA SKLÁDACÍ METRY

· osazení stojanu 13399



13401	· 15 ks
13402	· 15 ks
13403	· 15 ks
13404	· 15 ks
13405	· 15 ks
13406	· 15 ks
13412	· 15 ks
13413	· 15 ks
13414	· 15 ks
13415	· 15 ks
13416	· 15 ks
13417	· 15 ks
13418	· 15 ks
13419	· 15 ks
13420	· 15 ks
13421	· 10 ks
13422	· 10 ks
13423	· 10 ks
13424	· 10 ks
13425	· 10 ks
13426	· 10 ks
13427	· 10 ks
13428	· 10 ks
13429	· 10 ks
13430	· 10 ks
13431	· 10 ks
13432	· 10 ks
13433	· 10 ks
13434	· 10 ks
13435	· 10 ks
13436	· 10 ks
13437	· 10 ks
13438	· 10 ks
13439	· 10 ks
13440	· 10 ks

Č.p.	specifikace	
13399	Stojan osazený	1
13400	Stojan bez metrů	1

MĚŘIDLO POSUVNÉ DIGITÁLNÍ

FESTA

INOX



Č.p.	specifikace	
14007	150 0,01 mm	10
14008	200 0,01 mm	10
14009	300 0,01 mm	10



MĚŘIDLO POSUVNÉ DIGITÁLNÍ FIBERGLASS



· přesnost 0,2 mm, rozlišení 0,1 mm

Č.p.	specifikace	
14013	150 0,2 mm	10



MĚŘIDLO POSUVNÉ

FESTA

INOX

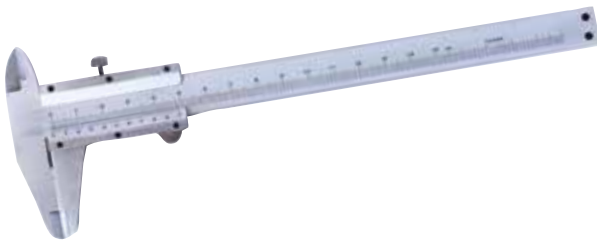

Č.p.	specifikace	
14001	150 0,02 mm	10
14002	200 0,02 mm	10
14003	300 0,02 mm	10



MĚŘIDLO POSUVNÉ

FESTA

INOX

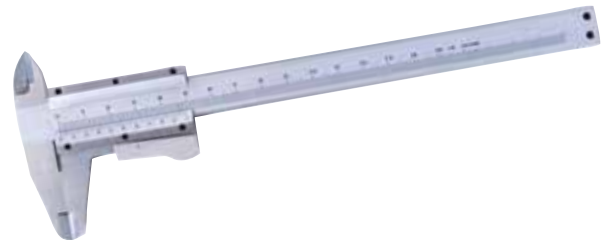

Č.p.	specifikace	
14004	150 0,02 mm	10



MIKROMETR

FESTA



Č.p.	specifikace	
14040	0 - 25 0,01 mm	10
14045	25 - 50 0,01 mm	10



MĚŘIDLO POSUVNÉ



HOBBY



Č.p.	specifikace	
14006	150 mm	50



ÚCHYLKOMĚŘ

FESTA

INOX



Č.p.	specifikace	
14035	0 - 10mm 0,01 mm	10



MĚRKY SPÁROVÉ



· 20 listů

Č.p.	specifikace	
14080	0,05 - 1 mm	10



ÚHLOMĚR S OTOČNÝM RAMENEM

FESTA

INOX



· včetně pouzdra

Č.p.	specifikace	
14060	0° - 180° · 150 x 200 mm	5
14070	0° - 180° · 300 x 500 mm	7

ÚHLOMĚR

HOBBY



Č.p.	specifikace	
14075	0° - 180° · 230 x 500 mm	30

ÚHELNÍK TRUHLÁŘSKÝ MULTIFUNKČNÍ

ALU



FESTA

Č.p.	specifikace	
14420	180 mm	10
14421	NEW 300 mm	10

ÚHELNÍK TRUHLÁŘSKÝ

FESTA
MADE IN EU



Č.p.	specifikace		Č.p.	specifikace	
14220	200 x 125 mm	10	14235	350 x 190 mm	10
14225	250 x 135 mm	10	14240	400 x 190 mm	10
14230	300 x 135 mm	10	14250	500 x 210 mm	10

ÚHELNÍK TESAŘSKÝ

FESTA
MADE IN EU



Č.p.	specifikace		Č.p.	specifikace	
14350	500 x 235 mm	10	14380	800 x 320 mm	10
14360	600 x 300 mm	10	14399	1000 x 360 mm	10
14370	700 x 300 mm	10			

ÚHELNÍK

ALU

FESTA



Č.p.	specifikace	
14450	190 x 355 mm	6
14451	200 x 405 mm	6

ÚHELNÍK



Č.p.	specifikace	
14410	300 x 200 mm	50
14411	600 x 400 mm	36

ÚHELNÍK ZEDNICKÝ



Č.p.	specifikace		Č.p.	specifikace	
14455	300 x 200 mm	50	14457	700 x 300 mm	40
14456	500 x 250 mm	50	14458	1000 x 450 mm	30

ÚHELNÍK PLOCHÝ

Zn

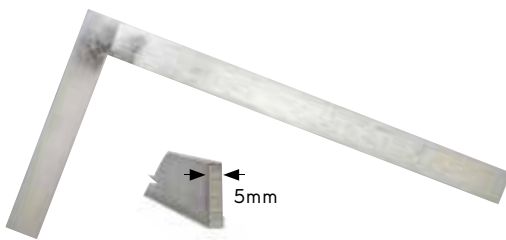

Č.p.	specifikace	
14471	150 x 100 mm	25
14472	250 x 125 mm	25
14473	400 x 200 mm	30
14474	600 x 300 mm	25

ÚHELNÍK PŘÍLOŽNÝ

Zn

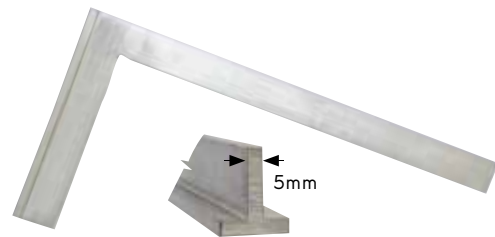

Č.p.	specifikace	
14490	100 x 50 mm	10
14491	150 x 75 mm	10
14492	250 x 125 mm	10
14493	400 x 200 mm	10
14494	600 x 300 mm	10

ÚHELNÍK TRUHLÁŘSKÝ

ALU

HOBBY



Č.p.	specifikace	
14425	250 x 130 mm	12
14430	300 x 130 mm	12
14435	350 x 156 mm	12
14440	400 x 156 mm	12

POKOSNÍK DŘEVĚNÝ



MADE IN EU



Č.p.	specifikace	
14025	255 x 285 mm	1

ŠABLONA NA KOPÍROVÁNÍ TVARŮ



· zámek



Č.p.	specifikace	
14090	125 x 30 mm	1
14091	250 x 30 mm	1

HORIZONT[®] EXACTA

Vodováhy s nejvyšší přesností

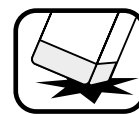
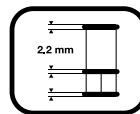
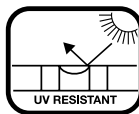
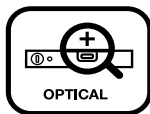
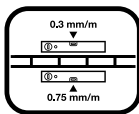

Každý kus je elektronicky testován a má své evidenční číslo, výrobce je držitelem certifikátu ISO 9001



VODOVÁHA EXACTA, 2 LIBELY

HORIZONT[®]
ALU

Č.p.	specifikace
15033	60 cm



10

VODOVÁHA EXACTA, 3 LIBELY

HORIZONT[®]
ALU

Č.p.	specifikace
15034	80 cm
15035	100 cm



10

10

VODOVÁHA EXACTA, 3 LIBELY, S MADLY

HORIZONT[®]
ALU

Č.p.	specifikace
15036	120 cm
15037	150 cm
15039	200 cm



10

10

10

HORIZONT®

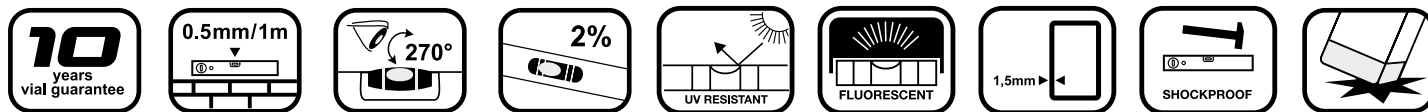

Každý kus je elektronicky testován a má své evidenční číslo, výrobce je držitelem certifikátu ISO 9001



VODOVÁHA, 2 LIBELY

HORIZONT®

ALU



Č.p.	specifikace	
15003	30 cm	30
15004	40 cm	30
15005	50 cm	30
15006	60 cm	30
15008	80 cm	30
15010	100 cm	30
15012	120 cm	10
15015	150 cm	10
15018	180 cm	10
15020	200 cm	10

VODOVÁHA, 3 LIBELY

HORIZONT®

ALU



Č.p.	specifikace	
15103	30 cm	30
15104	40 cm	30
15105	50 cm	30
15106	60 cm	30
15108	80 cm	30
15110	100 cm	30
15112	120 cm	10
15115	150 cm	10
15118	180 cm	10
15120	200 cm	10

VODOVÁHA, 2 LIBELY + MAGNET

HORIZONT

ALU

RUBBER
ENDS

Č.p.	specifikace	
15204	40 cm	30
15205	50 cm	30
15206	60 cm	30
15208	80 cm	30
15210	100 cm	30
15212	120 cm	10
15215	150 cm	10
15218	180 cm	10
15220	200 cm	10

VODOVÁHA SKLONOVÁ, 4 LIBELY

HORIZONT

ALU

RUBBER
ENDS

Č.p.	specifikace	
15230	80 cm	10

VODOVÁHA SKLONOVÁ, 1 LIBELA

HORIZONT

ALU

RUBBER
ENDS

Č.p.	specifikace	
15235	60 cm	1

LAŤ STAHOVACÍ - BEZ LIBEL

HORIZONT

ALU



Č.p.	specifikace	
15310	100 cm	10
15315	150 cm	10
15318	180 cm	10
15320	200 cm	10
15325	250 cm	10
15330	300 cm	10
15335	350 cm	10
15340	400 cm	10

LAŤ STAHOVACÍ - 1 LIBELA

HORIZONT

ALU



Č.p.	specifikace	
15415	150 cm	10
15418	180 cm	10
15420	200 cm	10
15425	250 cm	10
15430	300 cm	10

LAŤ STAHOVACÍ - 2 LIBELY

HORIZONT

ALU



Č.p.	specifikace	
15510	100 cm	10
15515	150 cm	10
15518	180 cm	10
15520	200 cm	10
15525	250 cm	10
15530	300 cm	10
15535	350 cm	10
15540	400 cm	5

LAŤ STAHOVACÍ - 2 MADLA, BEZ LIBEL

HORIZONT

ALU



Č.p.	specifikace	
15615	150 cm	10
15620	200 cm	10
15625	250 cm	10
15630	300 cm	10

LAŤ STAHOVACÍ - 2 MADLA, 2 LIBELY

HORIZONT

ALU



Č.p.	specifikace	
15710	100 cm	10
15715	150 cm	10
15720	200 cm	10
15725	250 cm	10
15730	300 cm	10
15735	350 cm	10
15740	400 cm	5



PROFIL TRAPÉZOVÝ

- trapézový profil slouží k jemnějším úpravám povrchu
- vhodné pro štukatéry a fasádníky
- vhodný pro tenkovrstvé omítky



PROFIL "h"

- "h" profil slouží k jemnějším úpravám povrchu
- vhodné pro štukatéry a fasádníky
- vhodná ke štukování stropních omítek

HORIZONT®



LAŤ STAHOVACÍ - TRAPÉZOVÝ PROFIL

HORIZONT®

ALU



Č.p.	specifikace	
15810	100 cm	10
15812	120 cm	10
15815	150 cm	10
15818	180 cm	10
15820	200 cm	10
15825	250 cm	10
15830	300 cm	10

LAŤ STAHOVACÍ - H PROFIL

HORIZONT®

ALU



Č.p.	specifikace	
15850	100 cm	10
15853	150 cm	10
15855	180 cm	10
15860	200 cm	10
15870	250 cm	10
15880	300 cm	10

STOJAN NA VODOVÁHY

HORIZONT®

· osazení stojanu 15998

15003	· 5 ks
15004	· 5 ks
15005	· 5 ks
15006	· 5 ks
15008	· 5 ks
15010	· 5 ks
15012	· 5 ks
15015	· 3 ks
15018	· 3 ks
15020	· 3 ks
15108	· 3 ks
15206	· 3 ks
15210	· 3 ks

Č.p.	specifikace	
15999	85 x 210 x 50 cm	1
15998	85 x 210 x 50 cm osazený	1

STOJAN NA VODOVÁHY A LAŤ

HORIZONT®

· osazení stojanu 15996

15004	· 5 ks
15005	· 5 ks
15006	· 5 ks
15008	· 5 ks
15010	· 5 ks
15012	· 5 ks
15015	· 5 ks
15018	· 5 ks
15020	· 5 ks
15315	· 2 ks
15320	· 2 ks
15325	· 3 ks
15515	· 2 ks
15520	· 2 ks
15525	· 3 ks

Č.p.	specifikace	
15997	55 x 75 x 40 cm	1
15996	55 x 75 x 40 cm osazený	1

- Přesnost 0,5 mm | 1 m (v základní poloze)
- UV stabilní kapalina libely
- Nárazuvzdorne gumové koncovky
- Tloušťka profilu základny 2,4 mm



VODOVÁHA NIVELA - 2 LIBELY

ALU

RUBBER
ENDSUV
STABLE

· gumové koncovky



Č.p.	specifikace	
15904	40 cm	30
15906	60 cm	30
15908	80 cm	30
15910	100 cm	30
15912	120 cm	20
15915	150 cm	10
15920	200 cm	20

VODOVÁHA - 3 LIBELY

ALU

HOBBY



Č.p.	specifikace	
15954	40 cm	60
15956	60 cm	60
15958	80 cm	60
15960	100 cm	30
15962	120 cm	30
15965	150 cm	30
15970	200 cm	30

SKLONOMĚŘ DIGITÁLNÍ

FESTA®



· pouzdro

- 0° - 360°
- přesnost $\pm 0,1^\circ$
- rozlišení $0,1^\circ$
- funkce automatického vypnutí
- funkce HOLD pro uchování naměřené hodnoty
- podsvícený display
- specifikace 60x60x25 mm
- baterie 1xAAA

· magnetická spodní strana

Č.p. specifikace

26218



1

VODOVÁHA DIGITÁLNÍ



- přesnost 0,5 mm | m
- rozlišení $0,1^\circ$
- funkce HOLD pro uchování naměřené hodnoty
- tloušťka profilu 1,8 mm

Č.p. specifikace

26215 600 mm



1

DIGITÁLNÍ ÚHLOMĚŘ

FESTA®



- LCD display
- rozsah měření
- rozlišení
- přesnost

0° - 360°
0,1°
 $\pm 0,3$



VODOVÁHA S DIGITÁLNÍM ÚHLOMĚŘEM

FESTA®

ALU



- LCD display
- rozsah měření
- rozlišení
- přesnost

0° - 225°
0,1°
 $\pm 0,3$



Č.p. specifikace

26217 200 mm



1

Č.p. specifikace

26216 300 mm



1

LASER KŘÍŽOVÝ SA-08



- 650 nm
- 2x AA baterie
- dosah 10 m

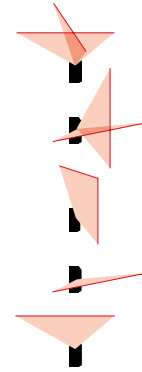

Č.p. specifikace
26205



VODOVÁHA NA PROVÁZEK

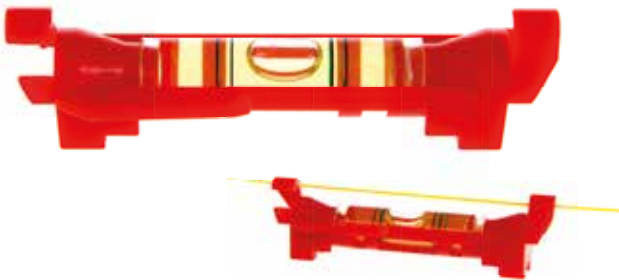

Č.p. specifikace
15981



VODOVÁHA S MAGNETEM, 3 LIBELY



Č.p. specifikace
15980 230 mm



VODOVÁHA SLOUPKOVÁ

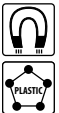

- 3 libely, magnety, fixační pásek



Č.p. specifikace
26028



VODOVÁHA HADICOVÁ



Č.p.	specifikace	1
15992	skleněné trubice - hadice 10 m	1
15993	skleněné trubice - hadice 15 m	1
15990	skleněné trubice	50
15991	plastové trubice	50

CLIMAPILOT

Laserliner®

Digitální vlhkoměr pro měření relativní vlhkosti a teploty prostředí s indikátorem rosného bodu

- praktický přístroj pro sledování klíma v místnosti
- digitální displej s min. | max. hodnotou
- přepínání mezi okolní teplotou | rosným bodem

1x
LR44
1,55V

Č.p.	specifikace	specifikace	specifikace	
	Rozsah měření okolní teploty:	0°C ... 50°C	Teplota rosného bodu:	-28,6°C ... 47,9°C
26460	Přesnost:	±1°C	Přesnost:	±2°C
	Relativní vlhkost vzduchu:	20% rH ... 90% rH	Dodáváno s:	baterie
	Přesnost:	±5%rH (25%rH... 85% rH)		

MOISTUREFINDER COMPACT

Laserliner®



Profesionální měření vlhkosti materiálů - rychlé a nedestruktivní

- nedestruktivní měření vlhkosti materiálu kapacitním měřením.
- jednoduchá manipulace: vyberte druh materiálu, pak přístroj přiložte na povrch materiálu ke stanovení obsahu vlhkosti v %
- 4 volitelné charakteristiky materiálu: měkké dřevo (např. smrk, borovice, lípa), tvrdé dřevo (např. buk, dub, bříza) omítka a cementový potěr
- led indikace vlhké | suché poskytne okamžitě výsledky měření pro stanovení obsahu vlhkosti v testovaném materiálu.

9V



Č.p.	specifikace:	
	Cementový potěr:	0% ... 5%
26527	Omítka:	0% ... 23%
	Měkké dřevo:	0% ... 52%
	Tvrdé dřevo:	0% ... 32%

DAMPFINDER COMPACT

Laserliner®



Univerzální přístroj pro měření vlhkosti dřeva a stavebních materiálů

- pro zjištění vlhkosti ve stavebních materiálech, pro rychlo kontrolu při práci se dřevem
- trojitá stupnice pro skupiny dřevo a, b a režim univerzálního přehledu
- numerické zobrazení naměřené hodnoty a okolní teploty
- osvětlený přehledný displej



4x AAA



Č.p.	specifikace	
	Dřevo:	0% ... 30% ± 1%, 30% ... 60% ± 2%
26464	Další materiály:	± 0,5 %
	Dodáváno s:	ochranný kryt s funkcí zkoušečky, baterie

LUXTEST-MASTER

Laserliner®



Profesionální měřicí přístroj intenzity osvětlení

- měření intenzity osvětlení na pracovištích, kancelářích, veřejných budovách a v průmyslu
- citlivé fotodiody s kosinovou korekcí pro širokouhlé měření světla
- relativní funkce měření pro referenční měření a porovnávání
- špičková funkce pro registraci rychlé změny v úrovni osvětlení.
- funkce automatického zapamatování hodnoty.
- automatické a manuální přepínání rozsahu
- funkce nulování
- měření proměnné: lux (lm | m²), nožní svíčky (lm | ft²)
- min. | max. displej
- 1 | 4" závit pro umístění na stativ

Č.p. specifikace

Rozsah měření: 20 Lux ... 200000 Lux

26520 Přesnost: ± 3% (referenční hodnota 2854 K)

Kosínus úhlová odchylka: ± 2% (30°), ± 6% (60°)



1

specifikace

Dodáno s: baterie, přepravní kufr

AIRFLOWTEST-MASTER

Laserliner®



Profesionální anemometr pro měření průtoku vzduchu, objemového průtoku a rychlosti větru

- integrovaný senzor pro měření okolní teploty, relativní vlhkosti a rosného bodu
- usb rozhraní pro ukládání naměřených dat
- pc software
- velké oběžné kolo: 65 mm.
- min. | max. displej.
- 1 | 4" závit pro připojení na stativ při dlouhodobém měření
- osvětlený, přehledný displej s trvale viditelnými hodnotami okolní teploty a relativní vlhkosti



Č.p. specifikace

Průtok: 0.80...30 m | s | ± 2%

Teplota okolního prostředí: -10...60°C | ± 1.5°C

26521 Relativní vlhkost vzduchu: 20%...80% | ± 3%

Proud vzduchu: 0...99990 CMM



NAHRÁVÁNÍ DAT NA PC

specifikace

Dodáno s: PC software, USB kabel, baterie, přepravní kufr



1

ACTIVEPEN

Laserliner®

SAFETY
CHECK

2x AAA

Bezpečná bezkontaktní kontrola napětí

- vyhledá elektrické napětí v kabelech, zásuvkách, objímkách žárovek a pojistkách
- určuje polaritu l | n vodičů např. na zásuvkách nebo v terminálech
- najde přerušení vodičů a kabelů
- výrazná led kontrolka pro signalizaci



specifikace

Dodáno s: baterie

Č.p. specifikace

26479 Rozsah měření napětí: 200 V | A... 600 V | AC, frekvence: 50... 60Hz



1

AC-TRACER

Laserliner®

9V



Bezkontaktní měřič trasy elektrického signálu přijímačky

- bezkontaktní trasování vysílaného signálu přijímačem
- rychlé trasování propojených elektrických obvodů
- lokace linek v propojených živých elektrických předmětech
- detekce jištěných obvodů v živé instalaci
- přijímač s akustickým signálem pro lokaci měřených předmětů
- přijímač s nastavitelnou citlivostí pro jemné nastavení
- adaptér do el. zásuvky pro přímou a rychlou kontrolu instalace
- žárovkový adaptér e27 pro přímou a rychlou kontrolu světelných okruhů



1

Č.p. specifikace

26343 Dodáváno s: přijímač RECV, konektor EURO, konektor UK (Velká Británie), E27 Adaptér lampy, baterie, kufřík

THERMOSPOT LASER

Laserliner®

 2x AAA

Bezdotykové infračervené měření teploty s integrovaným laserovým kruhem pro zacílení na měřený povrch

- bezkontaktní měření je ideální pro měření teploty v místech s obtížným přístupem, i pro aplikace, jako jsou pohyblivé části stroje či elektrické instalace
- 8-bodový laserový kruh měřící přesně potřebnou oblast
- rozsah měření: -38°C - 360°C
- emisní koeficient: 0,95
- čočka: 12:1

 Laser
650nm

 max: 30 m

Č.p. specifikace

26260 Dodáno s: baterie

1

CONDENSESPOT PLUS

Laserliner®

 2x AA

Infračervený teploměr tepelných mostů a kondenzace

- 8-bodový laserový kruh měřící přesně potřebnou oblast
- lokalizace kondenzace v režimu tepelného mostu a rosného bodu
- rozsah měření -40°C ... 365°C
- emisní poměr 0,01-1,0
- funkce barevného upozornění pomocí barev na displeji
- rychlý výběr 5 výchozích hodnot emisí
- sloupcový graf jako ukazatel pro kondenzaci vody
- čočka 12:1, přehledný podsvícený displej.

 Laser
650nm

1

Č.p. specifikace

Rozsah měření infračerveným paprskem: -40°C ... 365°C

Přesnost:

$\pm -40^{\circ}\text{C}$... 0°C ($\pm (1^{\circ}\text{C} + 0,1^{\circ}\text{C} | 1^{\circ}\text{C})$)

0°C ... 30°C ($\pm 1^{\circ}\text{C}$ or $\pm 1\%$, záleží na vyšší hodnotě)

$>30^{\circ}\text{C}$ ($\pm 2^{\circ}\text{C}$ or $\pm 2\%$, záleží na vyšší hodnotě)

26528 Teplota okolí: -20°C ... 65°C

Přesnost: $\pm 1^{\circ}\text{C}$ (0°C ... 50°C)

$\pm 2,5^{\circ}\text{C}$ ($<0^{\circ}\text{C}$ and $>50^{\circ}\text{C}$)

Vlhkost vzduchu (relativní): 1%...99%

Přesnost: $\pm 3\%$ (20%...80%)

$\pm 5\%$ ($<20\%$ and $>80\%$)

Dodáváno s: baterie

MULTIFINDER PLUS



Univerzální detektor pro vyhledávání dřeva, kovu, mědi, železa a živých vodičů

- jedno tlačítkové ovládání pro přepínání mezi různými režimy měření
- uživatelská příručka na lcd displeji pro jednoduché a spolehlivé použití
- auto-calibration_ hned po zapnutí přizpůsobí přístroj různým podkladům
- auto-cal plus: umožňuje snadné vymezení měřených objektů v režimu vyhledávání kovů
- akustické a vizuální detekce signálů při hledání objektů
- vysoké zabezpečení funkčnosti je zajištěno varovnými signály
- zvláštní funkce: v režimu "kov" je dokonce možné zjistit skryté dráty, které nejsou pod napětím
- podsvícení displeje



Laserliner®

9V

AUTO
CALIBRATION

1

Č.p. specifikace

26431 Dodáváno s:

baterie

STARFINDER PLUS



Elektronický detektor živých vedení

- jedno tlačítkové ovládání pro přepínání mezi různými režimy měření
- auto-calibration_ hned po zapnutí přizpůsobí přístroj různým podkladům
- akustické a vizuální detekce signálů při hledání objektů
- podsvícené displeje

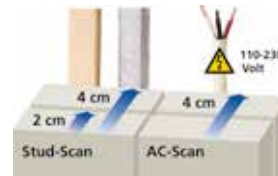

Laserliner®

9V

AUTO
CALIBRATION

1

Č.p. specifikace

26429 Dodáváno s:

baterie

COMBIFINDER PLUS



Elektronický detektor kovů a živých vodičů

- umožňuje cílené vyhledávání kovů jako je armovací železo, topenářské a vodovodní potrubí
- jedno tlačítkové ovládání pro přepínání mezi různými režimy měření
- uživatelská příručka na lcd displeji pro jednoduché a spolehlivé použití
- auto-calibration_ hned po zapnutí přizpůsobí přístroj různým podkladům
- auto-cal plus: umožňuje snadné vymezení měřených objektů v režimu vyhledávání kovů
- akustické a vizuální detekce signálů při hledání objektů
- vysoké zabezpečení funkčnosti je zajištěno varovnými signály
- podsvícený displej



Laserliner®

9V

AUTO
CALIBRATION

1

Č.p. specifikace

26430 Dodáváno s:

baterie

VIDEOSCOPE ONE

Kompaktní inspekční kamera pro vizuální kontrolu obtížně přístupných míst

- hlava kamery s ohebným kabelem obrázků přímo na lc monitoru
- výkonné osvětlení díky 4 vysoce výkonným led
- 2x digitální zoo s kroky po 10%
- dof: ohnisková vzdálenost 3 ... 7 cm
- extrémní monitory ovládané přes tv out připojení
- kompaktní hlava kamery je dostatečně malá tak, aby šlo nahlížet i do nepřístupných oblastí.
- manuální otáčení obrazu o 180° na monitoru
- hlava kamery: \varnothing 9 mm

Laserliner®

DISPLAY
2,7 LCD320 x 240
pixelZOOM
2x

4x AA

IP 67

LED
light1,5m
 \varnothing 9 mm

1

Č.p. specifikace

26523 Dodáváno s: VideoScope One 1,5 m, baterie

DISTANCECHECK

Laserliner®



Laserový měřič vzdálenosti, jednoduché ovládání

- vnitřní rozsah měření 0,05 - 20 m
- přesnost měření ± 2 mm (typická)*
- funkce výpočtu plochy a objemu umožňuje snadný výpočet použití množství materiálů
- průběžné měření min. | max.
- osvětlený otočný displej o 180°



Č.p. specifikace

26524

Dodáno s:

baterie

1

LASERRANGE-MASTER T3

Laserliner®



Laserový měřič vzdálenosti - měření dané vzdálenosti

- funkce výpočtu polohy a objemu umožňuje snadný výpočet použití množství materiálů
- pythagorova věta 1 + 2, funkce úhlu 1 + 2, měření průběžné
- snímač sklonu 360 st. pro určení vertikální a horizontální vzdálenosti
- 1/4" závit
- osvětlený 3 řádkový barevný led displej s dotykovou funkcí



Č.p. specifikace

26395

Dodáno s:

brašna, baterie

1

COMPACTCROSS - LASER PLUS

Laserliner®



Automatický křížový laser k vyrovnávání dlaždic, hrázdného zdiva, oken, dveří atd.

- doplňkový režim sklonu umožňuje osazovat také plochy se spádem
- rx-ready: integrovaný režim ručního přijímače
- rozhraní bluetooth® pro dálkové ovládání přístroje
- rozsah samočinné nivelace 4°, přesnost 0,35 mm |m



Č.p. specifikace

26037

Dodáno s:

baterie

1

SMARTCROSS-LASER



Automatický křížový laser s přidanou funkcí sklonu

- 5° samonivelační rozsah, přesnost 0,5 mm | 1 m
- funkce sklonu umožňuje uzamknout kyvadlový systém pro naklání přístroje a vypuštění paprsků pod libovolným úhlem
- out of level: je indikace pomocí optických signálů, když je jednotka mimo samonivelační rozsah.
- jednoduchý, konzistentní provoz



Laser
650nm



Č.p. specifikace

26440 Dodáno s: SmartCross-Laser, baterie

1

FLEXCLAMP



Univerzální svěrka

- vhodné pro všechny laserové přístroje s 1/4" závitem
- ukotvení k povrchu bez jeho poškození
- výška a postavení měřicího přístroje je snadno nastavitelná



Č.p. specifikace

26441 FlexClamp

1

AUTOCROSS - LASER 3C PLUS



Křížový laser pro vertikální i horizontální vyrovnávání

- přesné polohování laserových linií díky otočnému tělesu s jemným stranovým nastavením.
- nastavovací nohy se odnímatelnými gumovými krytkami
- rozsah samočinné nivelace 2,5°, Přesnost 0,2 mm | m
- snadná a přesná funkce olovnice s přídatnou laserovou olovnicí dole a laserovým křížem nahoře
- vertikální laserové linie jsou vůči sobě vyrovnané pravouhle

Laser
635nm



Č.p. specifikace

26526 Dodáno s: baterie

1

SUPERSQUARE-LASER 4

Laserliner®



90° čárový laser - ideální pro pokládku obkladů a dlažeb

- přesnost promítnutého úhlu 0,5 mm | 1 m
- 4 dobře viditelné laserové linie jsou ideální pro vyrovnání obkladů
- vertikální a horizontální vyrovnání na stěnách
- snadno se zajistí rovná hrana umístěných dlaždic
- čistá aplikace na všech površích pomocí kolíčků
- libely pro nastavení zařízení
- může být použit jako laserová vodováha



Č.p. specifikace

26495 Dodáno s: kolíčky, baterie

1

HANDYLASER PLUS

Laserliner®



Kompaktní univerzální laserová vodováha

- kombinuje výhody laserové vodováhy s malými vnějšími specifikace
- přesnost libel 0,5 mm | 1 m
- vertikální vyrovnání
- s vysoce přesným hranolem



Č.p. specifikace

26493 Dodáno s: nastavitelné nožičky, 90° pentagonální hranol, baterie

1

BRÝLE ZJASŇUJÍCÍ LASEROVÝ PAPERSEK

Laserliner®



Č.p. specifikace

26021 červené



1

ZNAČKOVAČ HLOUBKOVÝ HB



Č.p.	specifikace	
13262	150 mm	20
13263	náhradní tuhy 6 ks	20

TUŽKA S VÝMĚNITELNOU TUHOU HB

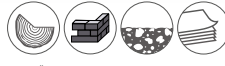

Č.p.	specifikace	
13279	tužka + náhradní tuha HB	24
13284	náhradní tuhy 5 ks	20

TUŽKA TESAŘSKÁ HB

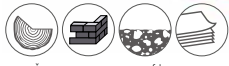

Č.p.	specifikace	
13270	HB · 180 mm	96
13271	HB · 180 mm · sada 3 ks	32
13265	HB · 250 mm	96

TUŽKA TESAŘSKÁ HB

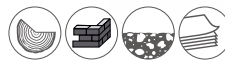

Č.p.	specifikace	
13269	HB · 180 mm	50
13266	HB · 250 mm	50

TUŽKA TESAŘSKÁ HB

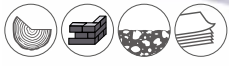

Č.p.	specifikace	
13272	HB · 250 mm	96
13264	HB · 250 mm · bez potisku	96

TUŽKA TESAŘSKÁ HB

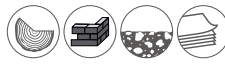

Č.p.	specifikace	
13268	250 mm	50

TUŽKA TROJHRANNÁ HB



Č.p.	specifikace	
13278	250 mm	96

TUŽKA TESAŘSKÁ HB

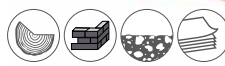

Č.p.	specifikace	
13280	180 mm	96

TUŽKA 6H



Č.p. specifikace
13275 6H - 250 mm

MOQ
12



96

TUŽKA NA SKLO A KERAMIKU



Č.p. specifikace
13273 175 mm červená tuha - sklo, keramika

MOQ
12



144

TUŽKA S BAREVNOU TUHOU



Č.p. specifikace
13274 175 mm, červeno - modrá

MOQ
12



96

TUŽKA S ČERVENOU TUHOU



Č.p. specifikace
13276 175 mm

MOQ
12



144

OŘEZÁVÁTKO NA TUŽKY



· smírek



Č.p.

13261



12

KŘÍDA BÍLÁ

12x



Č.p. specifikace
13260 12 x 12 x 80 mm



46

ZNAČKOVAČ UNIVERZÁLNÍ SADA 5 KS



5x



· Ø 13 x 110 mm

Č.p.	specifikace	20
13240	5 barev	20
13241	červená	20
13242	černá	20

Č.p.	specifikace	20
13243	žlutá	20
13244	zelená	20
13245	bílá	20



TUŽKY VOSKOVÉ SADA 6 KS

6x



Č.p. specifikace

13277



88

ZNAČKOVAČ PERMANENTNÍ



- extra silný hrot
- pro značení i na mastných a vlhkých površích



MOQ
12

č.p.	specifikace	
13216	červená	12
13217	černá	12
13218	modrá	12
13219	zelená	12



ZNAČKOVAČ PERMANENTNÍ



- 2 typy hrotu značkovače
- pro značení i na mastných a vlhkých površích



MOQ
12

č.p.	specifikace	
13227	bílá ALU pouzdro	40
13222	bílá PVC pouzdro	12
13228	červená ALU pouzdro	40
13229	černá ALU pouzdro	40
13230	modrá ALU pouzdro	12
13231	zelená ALU pouzdro	12



ZNAČKOVAČ PERMANENTNÍ



MOQ
12

č.p.	specifikace	
13214	bílý	12
13225	červená	12
13226	černá	12
13223	modrá	12
13224	zelená	12



ZNAČKOVAČ PERMANENTNÍ



MOQ
12

č.p.	specifikace	
13235	červená	12
13236	černá	12
13237	modrá	12
13238	zelená	12



ZNAČKOVACÍ PERMANENTNÍ, OBOUSTRANNÝ



ø 0,5 mm

Č.p. 13212 specifikace černý

MOQ 12

12

ZNAČKOVACÍ PERMANENTNÍ MINI

· délka fixu 9 cm



Č.p. 13205 specifikace

MOQ 72

72

JEHLA RÝSOVACÍ



Č.p. 13281 specifikace 150 mm

50

KRUŽÍTKO RÝSOVACÍ



Č.p. 13285 specifikace 200 mm

10

JEHLA RÝSOVACÍ



Č.p. 13282 specifikace 200 mm

50



SPREJ FLUORESCENČNÍ TRACKMARKER 500ML



- Vysoká viditelnost - fluorescenční pigment
- Bezpečnostní víčko
- Rychleschnoucí 10 min.
- Trvanlivost 3 měsíce
- Použití - Beton, Asfalt, Tráva, Štěrka, Písek, Kámen, Dřevo



Č.p.	specifikace	
13250	● žlutý	12
13251	● červený	12
13252	● oranžový	12
13253	● zelený	12
13254	● růžový	12
13249	● modrý	12

SPREJ FLUORESCENČNÍ MARK 6M FLUO 500 ML



- Vysoká viditelnost - fluorescenční pigment
- Bezpečnostní víčko
- Rychleschnoucí 10 min.
- Trvanlivost 6 měsíců
- Použití - Beton, Asfalt, Tráva, Štěrka, Písek, Kámen, Dřevo, Sklo



Č.p.	specifikace	
13360	● žlutý	12
13361	● červený	12
13362	● oranžový	12
13363	● zelený	12
13364	● růžový	12
13365	○ bílý	12

SPREJ FLUORESCENČNÍ FLUO 500 ML



- Vysoká viditelnost - fluorescenční pigment
- Bezpečnostní víčko
- Rychleschnoucí 10 min.
- Trvanlivost 12 měsíců
- Použití - Beton, Asfalt, Tráva, Štěrka, Písek, Kámen, Dřevo, Sklo



Č.p.	specifikace	
13350	● žlutý	12
13351	● červený	12
13352	● oranžový	12
13353	● zelený	12
13354	● růžový	12
13355	○ bílý	12

SPREJ FLUORESCENČNÍ IDEAL 500 ML



- Vysoká viditelnost - fluorescenční pigment
- Bezpečnostní víčko
- Rychleschnoucí 10 min.
- Trvanlivost 12 měsíců
- Použití - Beton, Asfalt, Tráva, Štěrk, Písek, Kámen, Dřevo



Č.p.	specifikace	
13255	● žlutý	12
13256	● červený	12
13257	● oranžový	12
13258	● zelený	12
13259	● růžový	12

DRŽÁK POJÍZDNÝ NA SPREJ SOPPEC



- pro spreje Trackmarker a Fluo

Č.p.	specifikace	
13296		1



DRŽÁK PISTOLOVÝ NA SPREJ SOPPEC



- pro spreje Trackmarker a Fluo

Č.p.	specifikace	
13295		1



40

KLEŠTĚ



44

SIKO KLEŠTĚ, HASÁKY



47

KLEŠTĚ PÁKOVÉ



48

NŮŽKY NA PLECH, NŮŽKY TECHNICKÉ



51

GOLA SADY A RÁČNY



59

HLAVICE, NÁSTAVCE. ADAPTÉRY



65

KLÍČE



71

ŠROUBOVÁKY



78

BITY



84

INBUSY, SADY



89

KLADIVA, PALICE



93

GUMOVÉ PALICE

DÍLENSKÉ NÁŘADÍ

38 - 133



95

SEKERY



97

PÁČIDLA



98

SEKÁČE, DLÁTA



101

SPONKOVAČKY



107

SVĚRKY A SVĚŘÁKY



109

PRACOVNÍ STOLY



110

KLEŠTĚ NÝTOVACÍ



114

SVÁŘENÍ

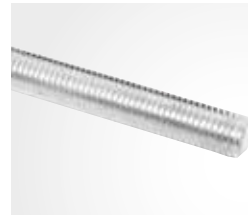

117

ZÁVITOVÉ TYČE, PODLOŽKY, MATICE



118

KOMPRESORY, STRÍKACÍ A OFUKOVACÍ PISTOLE



123

OCHRANNÉ POMŮCKY



129

NÁŘADOVÉ PÁSY, BRAŠNY A POUZDRA

FESTA®

ERGONOMIC handle



KLEŠTĚ KOMBINOVANÉ

FESTA®



DIN 5746

CrV · chrom vanadiová ocel

HRC 58-62 · tvrdost čelistí



ERGO HANDLE · ergonomické rukojeti z kvalitní TPE gumy

· indukčně kalené

Č.p.	specifikace	
17101	160 mm	6
17102	180 mm	6
17103	200 mm	6

KLEŠTĚ BOČNÍ ŠTÍPACÍ

FESTA®

NEW

DIN 5749 **TUV GS**

CrV **HRC 58-62**



Č.p.	specifikace	
17148	180 mm	6

KLEŠTĚ BOČNÍ ŠTÍPACÍ

FESTA®

DIN 5749 **TUV GS**

CrV **HRC 58-62**



Č.p.	specifikace	
17104	160 mm	6
17105	180 mm	6

KLEŠTĚ RADIOVÉ

FESTA®

DIN 5745 **TUV GS**

CrV **HRC 58-62**



Č.p.	specifikace	
17140	160 mm	6
17141	180 mm	6
17142	200 mm	6

KLEŠTĚ RADIOVÉ ZAHNUTÉ

FESTA®

DIN 5745 **TUV GS**

CrV **HRC 58-62**



Č.p.	specifikace	
17145	160 mm	6
17146	200 mm	6

KLEŠTĚ KOMBINOVANÉ

DIN 5746

FESTA

HRC 50-55



Č.p.	specifikace	
17001	160 mm	6
17002	180 mm	6
17003	200 mm	6

KLEŠTĚ BOČNÍ ŠTÍPACÍ

DIN 5749

FESTA

HRC 50-55



Č.p.	specifikace	
17004	160 mm	6
17005	180 mm	6

KLEŠTĚ BOČNÍ ŠTÍPACÍ

DIN 5749

FESTA

HRC 50-55



Č.p.	specifikace	
17108	180 mm	6

KLEŠTĚ ŠTÍPACÍ ČELNÍ

DIN 5749

FESTA

HRC 50-55



Č.p.	specifikace	
17110	160 mm	6

KLEŠTĚ RADIOVÉ

DIN 5745

FESTA

HRC 50-55



Č.p.	specifikace	
17006	160 mm	6
17011	200 mm	6

KLEŠTĚ RADIOVÉ ZAHNUTÉ

DIN 5745

FESTA

HRC 50-55



Č.p.	specifikace	
17007	160 mm	6
17008	200 mm	6

KLEŠTĚ PLOCHÉ

DIN 5746

FESTA

HRC 50-55



Č.p.	specifikace	
17009	160 mm	6

KLEŠTĚ OČKOVÉ

DIN 5745

FESTA

HRC 50-55



Č.p.	specifikace	
17010	160 mm	6

KLEŠTĚ ODIZOLOVÁVACÍ

DIN 5744

FESTA

HRC 50-55



Č.p.	specifikace	
17024	160 mm	6

KLEŠTĚ KOMBINOVANÉ

DIN 5746



Č.p.	specifikace	
17094	160 mm	6
17095	180 mm	6
17096	200 mm	6

KLEŠTĚ BOČNÍ ŠTÍPACÍ

DIN 5749



Č.p.	specifikace	
17097	160 mm	6
17098	180 mm	6

KLEŠTĚ RADIOVÉ

DIN 5745



Č.p.	specifikace	
17099	160 mm	6
17100	200 mm	6

VDE KLEŠTĚ KOMBINOVANÉ

DIN 5746

FESTA

CrV HRC 58-62



1000 V IEC/EN60900:2004



Č.p.	specifikace	
17125	160 mm	6
17126	180 mm	6
17127	200 mm	6

VDE KLEŠTĚ BOČNÍ ŠTÍPACÍ

DIN 5749

FESTA

CrV HRC 58-62



1000 V IEC/EN60900:2004



Č.p.	specifikace	
17128	160 mm	6

VDE KLEŠTĚ KABELOVÉ ŠTÍPACÍ

CrV HRC 58-62

FESTA



1000 V IEC/EN60900:2004



Č.p.	specifikace	
17130	160 mm	6

VDE KLEŠTĚ RADIOVÉ

DIN 5745

FESTA

CrV HRC 58-62



1000 V IEC/EN60900:2004



Č.p.	specifikace	
17133	160 mm	6

VDE KLEŠTĚ RADIOVÉ ZAHNUTÉ

DIN 5745

FESTA

CrV HRC 58-62



1000 V IEC/EN60900:2004



Č.p.	specifikace	
17135	160 mm	6

VDE KLEŠTĚ OČKOVÉ

DIN 5745

FESTA

CrV HRC 58-62



1000 V IEC/EN60900:2004



Č.p.	specifikace	
17137	160 mm	6

VDE KLEŠTĚ ODIZOLOVÁVACÍ

FESTA

CrV DIN 5744



1000 V IEC/EN60900:2004



Č.p.	specifikace	
17138	160 mm	6

KLEŠTĚ ODIZOLOVÁVACÍ



Č.p.	specifikace	
17180	Ø 0,75 - 2,5 mm	12

KLEŠTĚ ODIZOLOVÁVACÍ



Č.p.	specifikace	
17181	Ø 0,60 - 2,6 mm	10

KLEŠTĚ MULTIFUNKČNÍ

CrV

FESTA



- 9 funkcí
- pouzdro

Č.p.	specifikace
16232	



12

KLEŠTĚ MINI SADA

4x



Č.p. specifikace

17040

FESTA



6

KLEŠTĚ KOMBINOVANÉ MINI

FESTA



Č.p. specifikace

17041 110 mm



12

KLEŠTĚ BOČNÍ ŠTÍPACÍ MINI

FESTA



Č.p. specifikace

17042 110 mm



12

KLEŠTĚ ČELNÍ ŠTÍPACÍ MINI

FESTA



Č.p. specifikace

17043 100 mm



12

KLEŠTĚ RADIOVÉ MINI

FESTA



Č.p. specifikace

17044 120 mm



12

KLEŠTĚ OČKOVÉ MINI

FESTA



Č.p. specifikace

17045 120 mm



12

KLEŠTĚ NA SEGEROVY KROUŽKY

FESTA



Č.p. specifikace

17190 180 mm vnitřní

6

17191 180 mm vnější

6

KLEŠTĚ NA SEGEROVY KROUŽKY

FESTA



Č.p. specifikace

17192 180 mm vnitřní

15

17193 180 mm vnější

15

KLEŠTĚ NA SEGEROVY KROUŽKY



Č.p. specifikace

17025 sada



10

KLEŠTĚ MULTIFUNKČNÍ

CrV

FESTA



Č.p. specifikace

17109 270 mm



4

· pro montáž oplocení

KLEŠTĚ SIKO S TLAČÍTKEM



CrV



Č.p.	specifikace	rozsah čelistí	
17059	180 mm	0 - 30 mm	6
17061	250 mm	0 - 30 mm	6
17062	300 mm	0 - 40 mm	10
17080	400 mm	0 - 84 mm	10

KLEŠTĚ SIKO AUTOMATICKY STAVITELNÉ



CrV



Č.p.	specifikace	rozsah čelistí	
17079	250 mm	0 - 50 mm	6

KLEŠTĚ SIKO



CrV



· velký rozsah čelistí

Č.p.	specifikace	rozsah čelistí	
17086	250 mm	0 - 45 mm	6

KLEŠTĚ SIKO



CrV



Č.p.	specifikace	rozsah čelistí	
17081	180 mm	0 - 30 mm	6
17014	250 mm	0 - 30 mm	6
17082	300 mm	0 - 50 mm	6

KLEŠTĚ SIKO S TLAČÍTKEM



CrV



Č.p.	specifikace	rozsah čelistí	
17084	250 mm	0 - 30 mm	6

KLEŠTĚ SIKO



CrV



Č.p.	specifikace	rozsah čelistí	
17012	250 mm	0 - 40 mm	6
17060	300 mm	0 - 50 mm	10

KLEŠTĚ SIKO

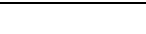

CrV



Č.p.	specifikace	rozsah čelistí	
17013	250 mm	0 - 30 mm	6
17033 NEW	300 mm	0 - 50 mm	6

ČELISTI PLASTOVÉ PRO KLEŠTĚ SIKO



· vhodné pro 17061, 17079, 17086

Č.p.	specifikace	
17085	1 pár	1

HASÁK 45°, S

CrV



Č.p.	specifikace	
17067	1" 330 mm	25
17068	1,5" 420 mm	18
17069	2" 540 mm	8

HASÁK 90°

CrV



Č.p.	specifikace	
17075	1" 330 mm	24
17076	1,5" 420 mm	20
17077	2" 540 mm	10

HASÁK 90°

CrV



Č.p.	specifikace	
17070	2,5" 355 mm	12
17071	3" 455 mm	8
17072	3,5" 610 mm	10

HASÁK SE STAVĚCÍM ŠROUBEM

HASÁK S VODÍCÍ MATICÍ

CrV



Č.p.	specifikace		Č.p.	specifikace	
17063	230 mm	6	17065	260 mm	36
17064	300 mm	6	17066	300 mm	36

KLEŠTĚ RYCHLOUPÍNACÍ

NEW



Č.p.	specifikace
17034	220 mm

5

KLEŠTĚ RYCHLOUPÍNACÍ



Č.p.	specifikace
17036	260 mm

5

KLEŠTĚ RYCHLOUPÍNACÍ



Č.p.	specifikace
17035	220 mm

10

KLEŠTĚ RYCHLOUPÍNACÍ



Č.p.	specifikace
17023	220 mm

6

KLEŠTĚ ŠTÍPACÍ ČELNÍ

CrV

FESTA®



Č.p.	specifikace
17300	160 mm
17301	180 mm
17302	200 mm

10

10

6

KLEŠTĚ RABITOVÉ

CrV

FESTA®



Č.p.	specifikace
17305	220 mm
17304	275 mm

5

6

KLEŠTĚ ŠTÍPACÍ ČELNÍ



Č.p.	specifikace
17015	160 mm
17016	180 mm
17017	200 mm

6

6

6

KLEŠTĚ RABITOVÉ



Č.p.	specifikace
17019	220 mm
17083	275 mm

6

6

KLEŠTĚ PÁKOVÉ PROFESIONÁLNÍ

FESTA

Cr-Mo

HRC 58-62



čelisti na kabely a lanka



Č.p.	specifikace	max. Ø drátu	max. Ø lanka	max. Ø kabelu	
17055	14' 360 mm	max. 5 mm < 45 HRC	max. 3,5 mm	max. 8 mm	1
17056	18' 460 mm	max. 6 mm < 45 HRC	max. 5 mm	max. 10 mm	1
17057	24' 610 mm	max. 8 mm < 45 HRC	max. 7 mm	max. 12 mm	1
17058	30' 760 mm	max. 10 mm < 45 HRC	max. 9 mm	max. 14 mm	1
17046 NEW	35' 900 mm	max. 12 mm < 45 HRC	max. 10 mm	max. 16 mm	1

KLEŠTĚ PÁKOVÉ PROFESIONÁLNÍ

FESTA

KLEŠTĚ PÁKOVÉ

Cr-Mo

HRC 58-62



Č.p.	specifikace	max. Ø drátu	
17051	14' 360 mm	max. 5 mm < 45 HRC	20
17052	18' 450 mm	max. 6 mm < 45 HRC	10
17053	24' 610 mm	max. 8 mm < 45 HRC	8
17054	30' 760 mm	max. 10 mm < 45 HRC	5
17048	36' 910 mm	max. 12 mm < 45 HRC	1



Č.p.	specifikace	max. Ø drátu	
17028	14' 350 mm	max. 5 mm < 30 HRC	30
17020	18' 450 mm	max. 6 mm < 30 HRC	6
17021	24' 610 mm	max. 8 mm < 30 HRC	10
17022	30' 760 mm	max. 10 mm < 30 HRC	5

KLEŠTĚ NA LANKA

FESTA

KLEŠTĚ NA LANA

FESTA

KLEŠTĚ PÁKOVÉ

CrV

max. Ø
6 mm

- ocelové dráty
- ACSR kabely
- letecké kabely

CrV

max. Ø
12 mm

- ocelové dráty
- ACSR kabely
- letecké kabely

max. Ø
5 mm



Č.p.	specifikace	
17029	200 mm	6



Č.p.	specifikace	
17039	24' 610 mm	8



Č.p.	specifikace	
17038	8' 210 mm	6

KLEŠTĚ KLEMPÍŘSKÉ ROVNÉ

NEW



FESTA

Č.p.	specifikace
17089	150 x 215 mm



KLEŠTĚ KLEMPÍŘSKÉ ROVNÉ

FESTA

KLEŠTĚ KLEMPÍŘSKÉ ROVNÉ

FESTA



Č.p.	specifikace
17093	95 x 270 mm



6

Č.p.	specifikace
17090	60 x 280 mm



10

KLEŠTĚ KLEMPÍŘSKÉ VYHNUTÉ 45°

FESTA

KLEŠTĚ KLEMPÍŘSKÉ VYHNUTÉ 90°

FESTA



Č.p.	specifikace
17091	60 x 280 mm



10

Č.p.	specifikace
17092	60 x 260 mm



10

NŮŽKY NA PLECH

FESTA

NŮŽKY NA PLECH

FESTA

Cr-Mo

Cr-Mo

HRC 58-62

HRC 58-62



Č.p.	specifikace	
17112	rovné 40 260 mm	6
17117	pravé 40 260 mm	6
17122	levé 40 260 mm	6



6

Č.p.	specifikace	
17111	rovné 40 250 mm	6
17116	pravé 40 250 mm	6
17121	levé 40 250 mm	6



6

NŮŽKY NA PLECH

CrV

FESTA



Č.p.	specifikace	
17170	50 250 mm	6

NŮŽKY NA PLECH

CrV

FESTA



Č.p.	specifikace	
17156	60 245 mm	6

NŮŽKY NA PLECH

CrV

FESTA



Č.p.	specifikace	
17155	70 260 mm	6

NŮŽKY NA PLECH

CrV



Č.p.	specifikace	
17167	70 300 mm	5

NŮŽKY NA PLECH

CrV



Č.p.	specifikace	
17165	60 250 mm	5

NŮŽKY NA PLECH

CrV



Č.p.	specifikace	
17169	35 250 mm	5

NŮŽKY PROSTRÍHOVACÍ NA PLECH

max 0,8 mm



Č.p.	specifikace	
17186	265 mm	1

NÁSTAVEC NA STRÍHÁNÍ PLECHU

Max. tloušťka plechu

- 1,8 mm - ocel
- 1,2 mm - nerez
- 2 mm - plasty, hliník, měď



Č.p.	specifikace	
20363		5

NŮŽKY PÁKOVÉ

17175	17177
max. 4mm	5mm
max. ø10mm	ø12mm
max. 8x8mm	10x10mm

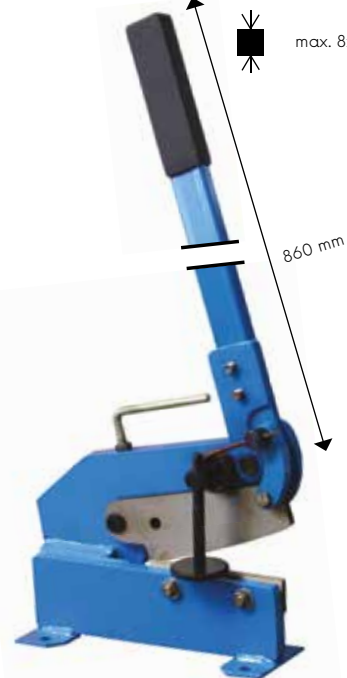

Č.p.	specifikace	
17175	150 mm	1
17177	250 mm	1

KLEŠTĚ DĚROVACÍ



Č.p. specifikace
17185 Ø 2; 2,5; 3; 3,5; 4; 4,5 mm

12

NŮŽKY NA PVC LIŠTY A TRUBKY



Použití pro: lišty, trubky, profily

Č.p. specifikace
17050 60 | 220 mm ø 16 mm, ø 19 mm, ø 25 mm

8

NŮŽKY TECHNICKÉ

INOX



Č.p. specifikace
16420 60 | 200 mm



12

NŮŽKY

INOX



Č.p. specifikace
17159 65 | 220 mm



12

NŮŽKY TECHNICKÉ

INOX



Č.p. specifikace
17158 50 | 150 mm



10

NŮŽKY - SADA

INOX

3x



Č.p. specifikace
16401 3 ks



48

NŮŽKY

INOX



Č.p. specifikace
17160 70 | 210 mm



12

NŮŽKY

INOX



Č.p. specifikace
16405 14 cm
16406 17 cm
16407 19 cm
16408 21,5 cm



24
24
24
12

FESTA®

10 years
guarantee

- Použití v průmyslu a servisech
- Kvalitní Chrom Vanadiová ocel
- Ráčna se 72 vybroušenými zuby pro tu nejvyšší práci
- Všechny komponenty dle DIN normy
- Vroubkované hlavice pro zlepšení úchopu
- Odolné plechové nebo plastové kufry



made by

HONITON

GOLA SADA

CrV

1/2"

13x



- 1/2" · 72 T
- 1/2" · 125 mm
- 1/2" · 8-9-10-11-12-13-14-15-17-19-22 mm

FESTA
made by
HONITON

10 years
guarantee

Č.p. specifikace

17210



1

GOLA SADA

CrV

1/4"

17x



- 1/4" · 72 T
- 1/4" · 50 mm, 100 mm
- 1/4"
- 1/4"
- 1/4" · 4-4,5-5-5,5-6-7-8-9-10-11-12-13 mm

FESTA
made by
HONITON

10 years
guarantee

Č.p. specifikace

17211



1

GOLA SADA

CrV

1/2"

25x



- 1/2"
- 1/2" · 125 mm, 250 mm
- 1/2"
- 16 mm, 21 mm
- 1/2"
- 1/2" · 10-11-12-13-14-15-16-17-18-19-20-21-22-23-24-27-30-32 mm

FESTA
made by
HONLTON



Č.p. specifikace

17212



4

GOLA SADA

CrV

1/2"

1/4"

59x



- 1/2", 1/4" · 72 T
- 1/2", 1/4"
- 1/4" · 150 mm
- 1/4" · 100 mm
- 1/2", 1/4"
- 1/2" · 125 mm, 250 mm
- 1/4" · 4-4,5-5-5,5-6-7-8-9-10-11-12-13 mm
- 1/2" · 10-11-12-13-14-15-17-19-21-22-24-27-30-32 mm
- 16 mm, 21 mm
- 18x
Inbus 3x

FESTA
made by
HONLTON



Č.p. specifikace

17214



4

GOLA SADA

CrV

1/2"

28x



- 1/2" · 72 T
- 1/2" · 125 mm, 250 mm
- 1/2"
- 16 mm, 21 mm
- 1/2"
- 1/2"
- 1/2" · 8-9-10-11-12-13-14-15-16-17-18-19-20-21-22-23-24-27-30-32 mm

FESTA
made by
HONLTON



Č.p. specifikace

17213



4

GOLA SADA

CrV

1/4"

16x



- 1/4" · 72 T
- 1/4" · 50 mm
- 1/4"
- 1/4"
- 1/4" · 4-4,5-5-5,5-6-7-8-9-10-11-12-13 mm

FESTA
made by
HONLTON



Č.p. specifikace

17215



1

GOLA SADA

CrV

1/2"

25x



- 1/2" · 72 T
- 1/2" · 125 mm, 250 mm
- 1/2"
- 16 mm, 21 mm
- 1/2"
- 1/2" · 10-11-12-13-14-15-16-17-18-19-20-21-22-23-24-27-30-32 mm

FESTA
made by
HENITON



Č.p. specifikace

17216



10

GOLA SADA

CrV

1/4"

32x



- 1/4" · 72 T
- 1/4" · 50 mm
- 1/4"
- 1/4"
- 1/4"
- 1/4" · 4-4,5-5-5,5-6-7-8-9-10-11-12-13 mm
- 12x
- Inbus 3x

FESTA
made by
HENITON



Č.p. specifikace

17217



1

GOLA SADA

CrV

1/4"

1/2"

56x



- 1/2", 1/4" · 72 T
- 1/2", 1/4"
- 1/4" 150 mm
- 1/4" 100 mm
- 1/2", 1/4"
- 1/2" · 125 mm, 250 mm
- 1/4" · 4-4,5-5-5,5-6-7-8-9-10-11-12-13 mm
- 1/2" · 10-11-12-13-14-15-17-19-21-22-24-27-30-32 mm
- 16 mm, 21 mm
- 16x
- Inbus 3x

FESTA
made by
HENITON



Č.p. specifikace

17218



4

GOLA SADA

CrV

1/4"

1/2"

94x



- 1/2", 1/4" · 72 T
- 1/2", 1/4"
- 1/4"
- 1/4" · 50 mm, 100 mm
- 1/2", 1/4"
- 1/2", 1/4"
- 1/2" 125 mm, 250 mm
- 1/4" · 4-4,5-5-5,5-6-7-8-9-10-11-12-13-14 mm
- 1/2" · 10-11-12-13-14-15-17-19-21-22-24-27-30-32 mm
- 1/4" · 6-7-8-9-10-11-12-13 mm
- 1/2" · 14-15-17-19-22 mm
- 16 mm, 21 mm
- 34x
- Inbus 3x

FESTA
made by
HENITON



Č.p. specifikace

17219



3

GOLA SADA

CrV

1/2"

27x



- 1/2" · 72 T
- 1/2" · 125 mm, 250 mm
- 1/2"
- 16 mm, 21 mm
- 1/2"
- 1/2" · 8-9-10-11-12-13-14-15-16-17-18-19-20-21-22-23-24-27-30-32 mm

FESTA
made by
HUNTON



Č.p. specifikace

17225



4

GOLA SADA

CrV

3/4"

14x



- 3/4" · 72 T
- 3/4" · 100 mm, 200 mm
- 3/4" · 460 mm
- 3/4" · 22-24-27-30-32-36-38-41-46-50 mm

FESTA
made by
HUNTON



Č.p. specifikace

17226



1

GOLA SADA

CrV

3/4"

21x



- 3/4" · 72 T
- 3/4" · 100 mm, 200 mm, 400 mm
- 3/4" · 460 mm
- 3/4" · 19-21-22-23-24-26-27-29-30-32-35-36-38-41-46-50 mm

FESTA
made by
HUNTON



Č.p. specifikace

17227



1

SADA HLAVIC INBUS

CrV

1/2"

9x



FESTA
made by
HUNTON



- 1/2" HEX · 4-5-6-7-8 -10-12-14-17 mm

Č.p. specifikace

17345



1

SADA HLAVIC TORX

CrV

1/2"

9x



FESTA
made by
HUNTON



- T20-T25-T27-T30-T40-T45-T50-T55-T60 mm

Č.p. specifikace

17346



1

HLAVICE NA KOLA

Cr-Mo

1/2"

3x



FESTA
made by
HUNTON

10 years
guarantee



Č.p.	specifikace	
17336	17 mm	5
17337	19 mm	5
17338	21 mm	5

HLAVICE NA KOLA

Cr-Mo

1/2"

3x



FESTA
made by
HUNTON

10 years
guarantee



1/2" · 17-19-21 mm

Č.p.	specifikace	
17335		1

RÁČNA

CrV



FESTA
made by
HUNTON

10 years
guarantee



Č.p.	specifikace	
17220	1/4" 36 zubů	20
17222	3/8" 36 zubů	10
17224	1/2" 36 zubů	6
17208	1/2" 72 zubů	6

SADA NÁSTRČNÝCH HLAVIC DRIVELOCK

CrV

1/4"

12x



4-5-5,5-6-7-8-9-10-11-12-13 mm

Č.p.	specifikace	
17250		10



SADA NÁSTRČNÝCH HLAVIC TORX

CrV

1/2"

1/4"

9x



1/4" · 5-6-7-8-10

1/2" · 12-14-16-18

Č.p.	specifikace	
17255		4

FESTA®

10 years
guarantee



Cr-Mo

- Použití v průmyslu a servisech
- Vysoce kvalitní Chrom Vanadiová ocel
- Ráčna se 72 vybroušenými zuby pro tu nejvyšší přesnost
- Všechny komponenty dle DIN normy
- Vroubkované hlavice pro zlepšení úchopu
- Odolný kufr s kovovými zámky a kovovými panty



SADA NÁŘADÍ

FESTA®

NEW

- CrV
- S2
- 1/4"
- 1/2"
- 72T
- 122x
- ERGO HANDLE



- 1/2", 1/4"
- 1/4" · 4-5-6-7-8-9mm
- 1/2" · 10-12-13-14-17-19mm
- 1/4" · 4-4.5-5-5.5-6-7-8-9-10-11-12-13-14mm
- 1/2" · 12-13-14-15-16-17-18-19-20-21-22-24mm
- 1/2", 1/4"
- 1/4" · 1/4"
- 1/4" · 150mm
- 1/2" · 254mm
- 1/2", 1/4"
- 1/2" · 16-21mm
- 1/4" · 150mm
- 1/2" · E10-E12-E14-E16-E18-E20-E22-E24
- 1/4" · S 3 · 4 · 5 · 6
- 1/4" · PH 0 · 1 · 2
- 1/4" · PZ 0 · 1 · 2
- 1/4" · S 4 · 5,5 · 6,5
- 1/4" · PH 1 · 2 · 3
- 1/4" · PZ 2 · 3
- 1/4" · H 3 · 4 · 5 · 6
- 1/4" · T 8 · 10 · 15 · 20 · 25
- 1/4" · TTα 10 · 15 · 20 · 25 · 40
- 2 · 2,5 · 3 · 4 · 5 · 6 · 7 · 8 · 10mm
- 8-9-10-11-12-13-14-15-16-17-18-19mm
- S 4x100 · 6,5x150
- PH 2x100 · 3x150
- 180mm
- 160mm
- 160mm
- 250mm
- 300g

Č.p. specifikace
17238 122 ks



GOLA SADA

FESTA®

- CrV
- 1/2"
- 72T
- 12x
- ERGO HANDLE



- 1/2" · 72T
- 1/2" · 125 mm
- 1/2" · 10-11-12-13-14-15-17-19-22-24 mm



Č.p. specifikace
17245 15

GOLA SADA

FESTA®

- CrV
- 1/2"
- 72T
- 12x
- ERGO HANDLE



- 1/2" · 72T
- 1/2" · 125 mm
- 1/2" · 10-11-12-13-14-15-17-19-22-24 mm



Č.p. specifikace
17229 8

GOLA SADA

FESTA

CrV

1/2"

72T

20x

ERGO HANDLE



10 years guarantee

- 1/2" · 72 T
- 1/2" · 75, 125 mm
- 1/2"
- 1/2" · 10-11-12-13-14-15-16-17-18-19-22-24 mm
- 1/2" · 17mm, 19mm
- 3 way adapter
- 16mm, 21mm



Č.p. specifikace

17230



4

GOLA SADA

FESTA

CrV

S2

1/4"

72T

36x

ERGO HANDLE



10 years guarantee

- 1/4" · 72 T
- 1/4" · 50, 100 mm
- 1/4"
- 1/4" · 4-5-5,5-6-7-8-10-11-12-13 mm
- 1/4" · 6-7-8-10-12-13 mm
- 3 way adapter
- 4 x
- 11x
- 1x



Č.p. specifikace

17231



10

GOLA SADA

FESTA

CrV

S2

1/4"

72T

46x

ERGO HANDLE



10 years guarantee

- 1/4"
- 1/4"
- 1/4" · 4-4,5-5-5,5-6-7-8-9-10-11-12-13-14 mm
- 1/4" · 50 mm, 100 mm
- 1/4"
- 1/4"
- 21 x
- 1/4"
- 1/4"



Č.p. specifikace

17233



10

GOLA SADA

FESTA

CrV

S2

1/4"

1/2"

72T

73x

ERGO HANDLE



10 years guarantee

- 1/2", 1/4" · 72T
- 1/4"
- 16 mm, 21 mm
- 1/4" · 10-11-12-13-14-15-16-17-18-19-20-21-22-23-24-27 mm
- 1/4" · 100 mm
- 1/2" · 125 mm, 250 mm
- 1/2"
- 1 x
- 1/4" · 4-5-5,5-6-7-8-10-11-12-13 mm
- 33 x



Č.p. specifikace

17234



4

GOLA SADA



- CrV** **S2**
- 1/4"**
- 1/2"**
- 72T**
- 94x**
- ERGO HANDLE**



- 1/2", 1/4" · 72T
- 1/4"
- 16 mm, 21 mm
- 1/4" · 4 -4,5-5-5,5-6-7-8-9-10-11-12-13-14 mm
- 1/2" · 10-11-12-13-14-15-16-17-18-19-20-21-22-23-24-27-30-32 mm
- 1/4" · 6-7-8-9-10-11-12-13 mm
- 1/2" · 14-15-17-19 mm
- 1/4" · 50 mm, 100 mm
- 1/2" · 125 mm, 250 mm
- 1/4"
- 5/16" bit holder
- 17x
- 15x
- 3 way adapter
- 3 x
- 1/4"
- L 1/4"
- 1/2", 1/4"

Č.p. specifikace

17235



GOLA SADA



- CrV** **S2**
- 1/4"**
- 1/2"**
- 72T**
- 110x**
- ERGO HANDLE**



- 1/2", 1/4" · 72T
- 150 mm
- 16 mm, 21 mm
- 1/4" · 4 -4,5-5-5,5-6-7-8-9-10-11-12-13-14 mm
- 1/2" · 10-11-12-13-14-15-16-17-18-19-20-21-22-24-27-30-32 mm
- 1/4" · 6-7-8-9-10-11-12-13 mm
- 1/2" · 14-15-17-19-22 mm
- 1/4" · 50 mm, 100 mm
- 1/2" · 125 mm, 250 mm
- E · 4-5-6-7-8-10-11-12-14-16-18-20-24-27-30-32 mm
- 1/2", 1/4"
- 5/16" bit holder
- 18 x
- 17 x
- 3 way adapter
- 4 x
- 1/4"
- L 1/4"

Č.p. specifikace

17236



GOLA SADA



- CrV** **S2**
- 1/4"**
- 1/2"**
- 3/8"**
- 72T**
- 171x**
- ERGO HANDLE**



- 1/2", 1/4", 3/8"
- 1/4" · 4-5-6-7-8-9-10mm
- 3/8" · 10-11-12-13-14-15mm
- 1/2" · 16-17-18-19-22mm
- 1/4" · 4-4,5-5-5,5-6-7-8-9-10-11-12-13-14mm
- 3/8" · 10-11-12-13-14-15-16-17-18-19mm
- 1/2" · 10-11-12-13-14-15-16-17-18-19-20-21-22-24-27-30-32mm
- 1/4" · E4-E5-E6-E7-E8
- 3/8" · E10-E11-E12-E14-E16-E18
- 1/2" · E20-E24
- 1/2" · 24x
- 1/4" · 20x
- 1/4" · 30x
- 1/4" · 50 mm, 100 mm
- 1/2" · 125 mm, 250 mm
- 3/8" · 150 mm
- 1/2" · 16-21mm
- 3/8" · 18mm
- 1/2", 1/4", 3/8" bit holder
- 1/2", 1/4", 3/8"
- 1/4" · 150mm
- 1/4" · 115mm
- Inbus 7X

Č.p. specifikace

17237



FESTA®



RÁČNY FESTA

- Ráčna je vyrobená z nejkvalitnější ChromVanadiové oceli
- Ráčna se 72 vybroušenými zuby pro tu nejpřesnější práci
- Kvalitní, ergonomická, dvoukomponentní rukojeť z měkčené TPE gumy
- SYSTÉM QUICK RELEASE pro snadnou a rychlou výměnu hlavice



RÁČNA

FESTA®



Č.p.	specifikace	délka	
17297	1/4"	155 mm	6
17298	3/8"	210 mm	5
17299	1/2"	255 mm	4

RÁČNA

FESTA®



Č.p.	specifikace	délka	
17240	1/4"	155 mm	10
17241	3/8"	200 mm	10
17242	1/2"	250 mm	5

RÁČNA

FESTA®



Č.p.	specifikace	délka	
17294	1/4"	155 mm	6
17295	3/8"	205 mm	10
17296	1/2"	255 mm	4

RÁČNA OTOČNÁ 1/4"

FESTA®



Č.p.	specifikace	
17292	1/4"	1

RÁČNA



HOBBY



Č.p.	specifikace	
17243	1/4"	25
17244	1/2"	25

ŠROUBOVÁK NA HLAVICE

FESTA®

1/4"

CrV



Č.p.	specifikace	
18603	1/4" 150 mm	10

HLAVICE UNIVERZÁLNÍ

CrV



1/2"



1/4"



1/2"

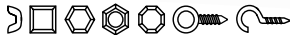

Č.p.	specifikace
17811	pro šrouby 11 - 32mm • 83mm x ø43mm

5

HLAVICE UNIVERZÁLNÍ

CrV



3/8"



1/4"



3/8"

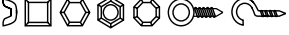

Č.p.	specifikace
17810	pro šrouby 7 - 19mm • 52mm x ø26mm

1

HLAVICE 1/4"

FESTA

CrV



1/4"



Č.p.	specifikace		Č.p.	specifikace	
17820	4 mm • 25 mm	10	17827	9 mm • 25 mm	10
17821	4,5 mm • 25 mm	10	17828	10 mm • 25 mm	10
17822	5 mm • 25 mm	10	17829	11 mm • 25 mm	10
17823	5,5 mm • 25 mm	10	17830	12 mm • 25 mm	10
17824	6 mm • 25 mm	10	17831	13 mm • 25 mm	10
17825	7 mm • 25 mm	10	17832	14 mm • 25 mm	10
17826	8 mm • 25 mm	10			

HLAVICE PRODLOUŽENÁ 1/4"

FESTA

CrV



1/4"



Č.p.	specifikace		Č.p.	specifikace	
17860	4 mm • 70 mm	10	17866	10 mm • 70 mm	10
17861	5 mm • 70 mm	10	17867	11 mm • 70 mm	10
17862	6 mm • 70 mm	10	17868	12 mm • 70 mm	10
17863	7 mm • 70 mm	10	17869	13 mm • 70 mm	10
17864	8 mm • 70 mm	10	17870	14 mm • 70 mm	10
17865	9 mm • 70 mm	10			

HLAVICE 1/2"

FESTA

CrV



1/2"



Č.p.	specifikace		Č.p.	specifikace	
17308	8 mm • 38 mm	10	17319	19 mm • 38 mm	10
17309	9 mm • 38 mm	10	17320	20 mm • 38 mm	10
17310	10 mm • 38 mm	10	17321	21 mm • 38 mm	10
17311	11 mm • 38 mm	10	17322	22 mm • 38 mm	10
17312	12 mm • 38 mm	10	17324	24 mm • 38 mm	10
17313	13 mm • 38 mm	10	17327	27 mm • 42 mm	20
17314	14 mm • 38 mm	10	17330	30 mm • 42 mm	25
17315	15 mm • 38 mm	10	17332	32 mm • 42 mm	20
17316	16 mm • 38 mm	10	17333	34 mm • 42 mm	20
17317	17 mm • 38 mm	10	17334	36 mm • 42 mm	20
17318	18 mm • 38 mm	10			

HLAVICE PRODLOUŽENÁ 1/2"

FESTA

CrV



1/2"



Č.p.	specifikace		Č.p.	specifikace	
17871	10 mm • 70 mm	10	17882	21 mm • 70 mm	10
17872	11 mm • 70 mm	10	17883	22 mm • 70 mm	10
17873	12 mm • 70 mm	10	17884	23 mm • 70 mm	10
17874	13 mm • 70 mm	10	17885	24 mm • 70 mm	10
17875	14 mm • 70 mm	10	17886	25 mm • 70 mm	10
17876	15 mm • 70 mm	10	17887	26 mm • 70 mm	10
17877	16 mm • 70 mm	10	17888	27 mm • 70 mm	10
17878	17 mm • 70 mm	10	17889	28 mm • 70 mm	10
17879	18 mm • 70 mm	10	17890	30 mm • 70 mm	10
17880	19 mm • 70 mm	10	17891	32 mm • 70 mm	10
17881	20 mm • 70 mm	10	17892	34 mm • 70 mm	10



HLAVICE 3/4"

FESTA

CrV



3/4"



Č.p.	specifikace		Č.p.	specifikace	
17835	17 mm · 48 mm	10	17846	33 mm · 55 mm	10
17836	18 mm · 48 mm	10	17847	36 mm · 60 mm	10
17837	19 mm · 48 mm	10	17848	38 mm · 60 mm	10
17838	21 mm · 48 mm	10	17849	41 mm · 65 mm	10
17839	22 mm · 48 mm	10	17850	46 mm · 65 mm	10
17840	24 mm · 48 mm	10	17851	50 mm · 70 mm	10
17841	26 mm · 48 mm	10	17852	55 mm · 75 mm	10
17842	27 mm · 52 mm	10	17853	60 mm · 78 mm	10
17843	28 mm · 52 mm	10	17854	65 mm · 82 mm	10
17844	30 mm · 52 mm	10	17855	70 mm · 82 mm	10
17845	32 mm · 52 mm	10	17856	75 mm · 88 mm	10

HLAVICE MULTILOCK 1/4"

FESTA

CrV



1/4"



Č.p.	specifikace		Č.p.	specifikace	
17895	4 mm · 25 mm	10	17902	9 mm · 25 mm	10
17896	4,5 mm · 25 mm	10	17904	11 mm · 25 mm	10
17897	5 mm · 25 mm	10	17905	12 mm · 25 mm	10
17898	5,5 mm · 25 mm	10	17907	14 mm · 25 mm	10
17900	7 mm · 25 mm	10			

HLAVICE MULTILOCK 1/2"

FESTA

CrV



1/2"



Č.p.	specifikace		Č.p.	specifikace	
17910	8 mm · 38 mm	10	17922	21 mm · 38 mm	10
17912	10 mm · 38 mm	10	17924	24 mm · 38 mm	10
17913	11 mm · 38 mm	10	17925	27 mm · 38 mm	10
17914	12 mm · 38 mm	10	17926	30 mm · 38 mm	10
17916	14 mm · 38 mm	10	17927	32 mm · 38 mm	10
17921	19 mm · 38 mm	10			

HLAVICE TORX 1/4"

FESTA

CrV



1/4"



Č.p.	specifikace		Č.p.	specifikace	
17930	E4	10	17933	E7	10
17931	E5	10	17934	E8	10
17932	E6	10	17935	E10	10

HLAVICE TORX 1/2"

FESTA

CrV



1/2"



Č.p.	specifikace	
17943	E22	10
17944	E24	10

NÁSTAVEC ŠROUBOVACÍ 1/4"

FESTA

CrV S2



1/4"



Č.p.	specifikace	
18920	S 4 mm	10
18921	S 5,5 mm	10
18922	S 7 mm	10

NÁSTAVEC ŠROUBOVACÍ 1/4"

FESTA

CrV S2



1/4"



Č.p.	specifikace	
18925	PH 1	10
18926	PH 2	10
18927	PH 3	10

NÁSTAVEC ŠROUBOVACÍ 1/4"

FESTA

CrV S2



1/4"



Č.p.	specifikace	
18928	PZ 0	10
18929	PZ 1	10
18930	PZ 2	10
18931	PZ 3	10

NÁSTAVEC ŠROUBOVACÍ 1/2"

FESTA

CrV S2



1/2"



Č.p.	specifikace		Č.p.	specifikace	
18967	M 8	10	18970	M 14	10
18968	M 10	10	18971	M 16	10
18969	M 12	10	18972	M 18	10

NÁSTAVEC ŠROUBOVACÍ 1/4"

FESTA

CrV S2



1/4"



Č.p.	specifikace		Č.p.	specifikace	
18934	3 mm	10	18937	6 mm	10
18935	4 mm	10	18939	8 mm	10

NÁSTAVEC ŠROUBOVACÍ 1/2"

FESTA

CrV S2



1/2"



Č.p.	specifikace		Č.p.	specifikace	
18944	12 mm	10			
18945	14 mm	10			

NÁSTAVEC ŠROUBOVACÍ 1/4"

FESTA

CrV S2



1/4"



Č.p.	specifikace	
18948	T 5	10
18950	T 8	10
18951	T 10	10

NÁSTAVEC ŠROUBOVACÍ 1/2"

FESTA

CrV S2



1/2"



Č.p.	specifikace		Č.p.	specifikace	
18954	T 10	10	18960	T 40	10
18955	T 15	10	18961	T 45	10
18956	T 20	10	18963	T 55	10
18957	T 25	10			

ADAPTÉR



CrV



Č.p.	specifikace	
17410	A - 1/4" B - 3/8"	10
17411	A - 3/8" B - 1/4"	10
17412	A - 3/8" B - 1/2"	10
17413	A - 1/2" B - 3/8"	10

Č.p.	specifikace	
17414	A - 1/2" B - 3/4"	10
17415	A - 3/4" B - 1/2"	10
17416	A - 1/4" B - 1/2"	10

KARDAN



CrV



Č.p.	specifikace	
17405	1/4" · 39 mm	10
17406	1/2" · 71 mm	10
17407	3/4" · 105 mm	10

JEZDEC NA „T“ VRATIDLO



CrV



Č.p.	specifikace	
17420	1/4"	1
17421	1/2"	1
17422	3/4"	1

„T“ VRATIDLO



CrV



Č.p.	specifikace	
17382	1/4" · 115 mm	1
17383	3/8" · 190 mm	1
17384	1/2" · 250 mm	1
17385	3/4" · 460 mm	1
17386	1" · 640 mm	1

„T“ NÁSTAVEC PRODLOUŽENÝ S KLOUBEM



CrV



Č.p.	specifikace	
17401	1/4" · 250 mm	1
17402	1/2" · 400 mm	1



VRATIDLO KLOUBOVÉ - TRHÁK

FESTA

CrV



Č.p.	specifikace	
17380	1/2" · 350 mm	1
17381	3/4" · 500 mm	1

RUKOJEŽ OHNUTÁ

FESTA

CrV

1/2"



Č.p.	specifikace	
17427	1/2" · 60 x 320 mm	1

NÁSTAVEC PRODLUŽOVACÍ

FESTA

CrV



Č.p.	specifikace		Č.p.	specifikace	
17390	1/4" · 50 mm	1	17395	1/2" · 250 mm	1
17391	1/4" · 100 mm	1	17396	3/4" · 100 mm	1
17392	1/4" · 150 mm	1	17397	3/4" · 200 mm	1
17393	1/2" · 75 mm	1	17398	3/4" · 400 mm	1
17394	1/2" · 125 mm	1			

NÁSTAVEC FLEXIBILNÍ

FESTA

CrV

1/4"



Č.p.	specifikace	
17400	1/4" · 150 mm	1

ADAPTÉR RÁČNA 1/4" - BIT

Stahlberg

CrV



1/4" ↔ 1/4"

Č.p.	specifikace	
18619		5

SADA ADAPTÉRŮ DO VRTAČKY

CrV



1/4"

3x



Č.p.	specifikace	
18604	1/4", 3/8", 1/2"	10

KLÍČ NA RADIÁTOROVÉ ŠROUBENÍ

FESTA

CrV

1/2"

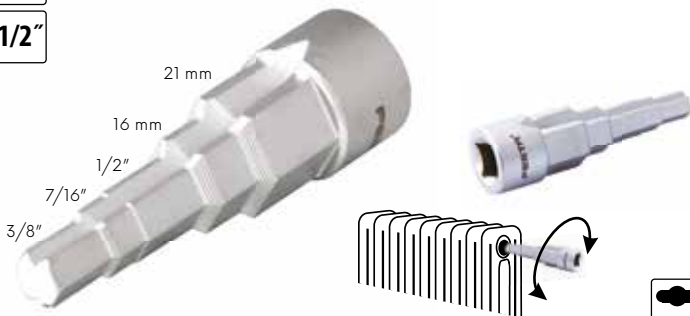

Č.p.	specifikace	
17455	pro ráčnu 1/2"	10

KLÍČ UNIVERZÁLNÍ K ROZVODNÝM SKŘÍNÍM

FESTA

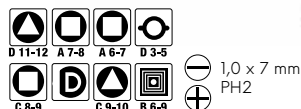

Č.p.	specifikace	
17456		50

FESTA®

- Kované klíče z kvalitní CrV oceli
- Vyrobeno dle DIN normy
- Chromová povrchová úprava



KLÍČ OBOUSTRANNÝ OTEVŘENÝ

CrV

DIN 3110



Č.p.	specifikace		Č.p.	specifikace	
17550	6 x 7 mm	10	17592	19 x 22 mm	10
17551	8 x 9 mm	10	17593	19 x 24 mm	10
17552	8 x 10 mm	10	17561	20 x 22 mm	10
17553	10 x 11 mm	10	17569	21 x 23 mm	10
17590	10 x 13 mm	10	17548	22 x 24 mm	10
17554	12 x 13 mm	10	17562	24 x 27 mm	10
17555	14 x 15 mm	10	17549	24 x 30 mm	10
17556	13 x 16 mm	10	17563	30 x 32 mm	10
17557	13 x 17 mm	10	17564	30 x 34 mm	10
17591	14 x 17 mm	10	17565	32 x 36 mm	10
17558	16 x 17 mm	10	17566	36 x 41 mm	10
17559	17 x 19 mm	10	17567	46 x 50 mm	10
17560	18 x 19 mm	10	17568	55 x 60 mm	3

KLÍČ OČKOPLOCHÝ

CrV

DIN 3113



Č.p.	specifikace		Č.p.	specifikace	
17487	6 mm	10	17489	21 mm	10
17570	7 mm	10	17583	22 mm	10
17571	8 mm	10	17490	23 mm	10
17572	9 mm	10	17584	24 mm	10
17573	10 mm	10	17491	25 mm	10
17574	11 mm	10	17492	26 mm	10
17575	12 mm	10	17585	27 mm	10
17576	13 mm	10	17493	28 mm	10
17577	14 mm	10	17494	29 mm	10
17578	15 mm	10	17586	30 mm	10
17579	16 mm	10	17587	32 mm	10
17580	17 mm	10	17495	33 mm	10
17581	18 mm	10	17496	34 mm	10
17582	19 mm	10	17589	36 mm	10
17488	20 mm	10			

KLÍČ RÁČNOVÝ KLOUBOVÝ

CrV

72T



Č.p.	specifikace		Č.p.	specifikace	
17628	8 mm	10	17625	17 mm	10
17622	10 mm	10	17631	18 mm	10
17623	13 mm	10	17626	19 mm	10
17624	14 mm	10	17632	21 mm	5
17629	15 mm	10	17633	22 mm	5
17630	16 mm	5			

KLÍČ RÁČNOVÝ

CrV

72T



Č.p.	specifikace		Č.p.	specifikace	
17660	6 mm	10	17669	16 mm	10
17676	7 mm	10	17670	17 mm	10
17661	8 mm	10	17671	18 mm	10
17662	9 mm	10	17672	19 mm	10
17663	10 mm	10	17674	21 mm	5
17664	11 mm	10	17675	22 mm	5
17665	12 mm	10	17677	24 mm	5
17666	13 mm	10	17678	27 mm	5
17667	14 mm	10	17679	30 mm	5
17668	15 mm	10	17683	32 mm	5

KLÍČ OČKOVÝ, VYHNUTÝ

FESTA

CrV

DIN 838



Č.p.	specifikace		Č.p.	specifikace	
17605	6 x 7 mm	10	17610	14 x 15 mm	10
17606	8 x 9 mm	10	17613	16 x 17 mm	10
17607	8 x 10 mm	10	17614	18 x 19 mm	10
17608	10 x 11 mm	10	17615	20 x 22 mm	10
17609	12 x 13 mm	10	17616	24 x 27 mm	10
17611	13 x 16 mm	10	17617	30 x 32 mm	10
17612	13 x 17 mm	10			

KLÍČ OBOUSTRANNÝ OTEVŘENÝ DIN 895

FESTA

DIN 895



Č.p.	specifikace		Č.p.	specifikace	
17460	6 x 7 mm	10	17469	17 x 19 mm	10
17461	8 x 9 mm	10	17470	18 x 19 mm	10
17462	8 x 10 mm	10	17483	19 x 22 mm	10
17463	10 x 11 mm	10	17484	19 x 24 mm	10
17481	10 x 13 mm	10	17471	20 x 22 mm	10
17464	12 x 13 mm	10	17472	24 x 27 mm	10
17465	14 x 15 mm	10	17486	21 x 23 mm	10
17466	13 x 16 mm	10	17480	28 x 30 mm	10
17467	13 x 17 mm	10	17473	30 x 32 mm	10
17482	14 x 17 mm	10	17485	36 x 41 mm	10
17468	16 x 17 mm	10			

KLÍČ OBOUSTRANNÝ OTEVŘENÝ

FESTA

CrV

DIN 3110



Č.p.	specifikace		Č.p.	specifikace	
17762	13 x 16 mm	10	17766	18 x 19 mm	10
17761	14 x 15 mm	10	17769	20 x 22 mm	10

KLÍČ OČKOPLOCHÝ

FESTA

CrV

DIN 3113



Č.p.	specifikace		Č.p.	specifikace	
17788	14 mm	10	17795	21 mm	10
17789	15 mm	10	17806	33 mm	10

KLÍČ UNIVERZÁLNÍ

Cr-Mo



12-13-14-15 mm

16-17-18-19 mm



Č.p.	specifikace	
17685	12-13-14-15-16-17-18-19 mm	1

KLÍČ STAVITELNÝ

FESTA

CrV



Č.p.	rozsah	délka	
17197	0 - 29 mm	200 mm	1
17198	0 - 33 mm	250 mm	1
17199	0 - 38 mm	300 mm	1

KLÍČ STAVITELNÝ



Č.p.	rozsah	délka	
17200	0 - 24 mm	200 mm	6
17201	0 - 30 mm	250 mm	6
17202	0 - 34 mm	300 mm	6

KLÍČ OBOUSTRANNÝ OTEVŘENÝ - SADA

CrV

FESTA

DIN 3110



Č.p.	specifikace	
17506	6 ks · 6 x 7, 8 x 9, 10 x 11, 12 x 13, 14 x 15, 16 x 17	1
17508	8 ks · 6 x 7, 8 x 9, 10 x 11, 12 x 13, 14 x 15, 16 x 17, 18 x 19, 20 x 22	1

KLÍČ OČKOPLOCHÝ - SADA

CrV

FESTA

DIN 3113



Č.p.	specifikace	
17526	6 ks · 10 x 10, 11 x 11, 13 x 13, 14 x 14, 16 x 16, 17 x 17	1
17528	8 ks · 8 x 8, 10 x 10, 11 x 11, 13 x 13, 14 x 14, 16 x 16, 17 x 17, 19 x 19	1

KLÍČ OČKOVÝ VYHNUTÝ - SADA

CrV

FESTA

DIN 838

8x



Č.p.	specifikace	
17539	6 x 7, 8 x 9, 10 x 11, 12 x 13, 14 x 15, 16 x 17, 18 x 19, 20 x 22	1

KLÍČ OČKOPLOCHÝ - SADA

CrV

DIN 3113



FESTA

KLÍČ OBOUSTRANNÝ OTEVŘENÝ - SADA

CrV

DIN 3110

12x



FESTA



Č.p.	specifikace	
17512	6 x 7, 8 x 9, 10 x 11, 12 x 13, 14 x 15, 16 x 17, 18 x 19, 20 x 22, 21 x 23, 24 x 27, 25 x 28, 30 x 32	1



Č.p.	specifikace	
17532	12 ks · 8 x 8, 9 x 9, 10 x 10, 11 x 11, 13 x 13, 14 x 14, 16 x 16, 17 x 17, 18 x 18, 19 x 19, 21 x 21, 22 x 22	10
17533	18 ks · 6 x 6, 7 x 7, 8 x 8, 9 x 9, 10 x 10, 11 x 11, 12 x 12, 13 x 13, 14 x 14, 15 x 15, 16 x 16, 17 x 17, 18 x 18, 19 x 19, 20 x 20, 21 x 21, 22 x 22, 24 x 24	1
17534	25 ks · 6 x 6, 7 x 7, 8 x 8, 9 x 9, 10 x 10, 11 x 11, 12 x 12, 13 x 13, 14 x 14, 15 x 15, 16 x 16, 17 x 17, 18 x 18, 19 x 19, 20 x 20, 21 x 21, 22 x 22, 23 x 23, 24 x 24, 25 x 25, 26 x 26, 27 x 27, 28 x 28, 30 x 30, 32 x 32	4

KLÍČ OTEVŘENÝ - SADA DIN 895

DIN 895

FESTA



Č.p.	specifikace	
17475	8 ks · 6 x 7, 8 x 9, 10 x 11, 12 x 13, 14 x 15, 16 x 17, 18 x 19, 20 x 22	5
17476	12 ks · 6 x 7, 8 x 9, 10 x 11, 12 x 13, 14 x 15, 16 x 17, 18 x 19, 20 x 22, 21 x 23, 24 x 27, 28 x 30, 30 x 32	3

KLÍČ RÁČNOVÝ - SADA

FESTA

CrV

72T

7x



Č.p.	specifikace	
17620	8, 10, 12, 13, 14, 17, 19	5

KLÍČ RÁČNOVÝ, KLOUBOVÝ - SADA

FESTA

NEW

CrV

72T

7x



Č.p.	specifikace	
17621	10, 12, 13, 14, 15, 17, 19	5

KLÍČ TRUBKOVÝ - SADA

FESTA

CrV

7x



Č.p.	specifikace	
17501	6 x 7, 8 x 9, 10 x 11, 12 x 13, 14 x 15, 16 x 17, 18 x 19	20
17640	páka na trubkové klíče · 135 mm	50

KLÍČ TRUBKOVÝ

FESTA

CrV



Č.p.	specifikace		Č.p.	specifikace	
17650	6 x 7 mm	10	17655	16 x 17 mm	10
17651	8 x 9 mm	10	17645	16 x 18 mm	10
17642	8 x 10 mm	10	17653	16 x 21 mm	10
17652	10 x 11 mm	10	17656	18 x 19 mm	10
17643	12 x 13 mm	10	17657	19 x 22 mm	10
17654	14 x 15 mm	10	17659	22 x 24 mm	10
17644	14 x 17 mm	10	17658	24 x 27 mm	10

KLÍČ HÁKOVÝ

FESTA

CrV



Č.p.	specifikace	
17680	19 - 51 mm 165 mm	5
17681	32 - 76 mm 216 mm	5
17682	51 - 121 mm 267 mm	5

MATICE RYCHLOUPÍNACÍ PRO ÚHLOVÉ BRUSKY

NEW

M14



Č.p.	specifikace	
20969		1

KLÍČ PRO ÚHLOVÉ BRUSKY, STAVITELNÝ



Č.p.	specifikace	
20967	200 mm	15

KLÍČ NA ÚHLOVÉ BRUSKY



Č.p.	specifikace	
20968	200 mm	1

KLÍČ MOMENTOVÝ



Č.p.	specifikace	
17203	1/4" 5 - 25 Nm	1
17204	1/2" 19 - 110 Nm	1
17205	1/2" 42 - 210 Nm	1
17206	3/4" 140 - 700 Nm	1

RÁČNA LEŠENÁŘSKÁ



Č.p.	specifikace	
17451	18 mm	10
17450	19 mm	10

KLÍČ NA KOLA



Č.p.	specifikace	
17600	17, 19, 22 mm, 13/16"	16

KLÍČ NA KOLA



Č.p.	specifikace	
17601	17, 19, 21 mm	20

KLÍČ NA KOLA SKLÁDACÍ



Č.p.	specifikace	
17602	17, 19, 21, 23 mm	5

KLÍČ TELESKOPICKÝ NA KOLA



Č.p.	specifikace	
17603	17 x 19 mm, 21 x 23 mm	20

KLÍČ NÁSTRČNÝ KLOUBOVÝ



Č.p.	specifikace	
17261	16 mm	1
17262	21 mm	1

DRŽÁK MAGNETICKÝ

FESTA



Č.p. specifikace

70098

12

TELESKOP MAGNETICKÝ S LED OSVĚTLENÍM

FESTA

NEW

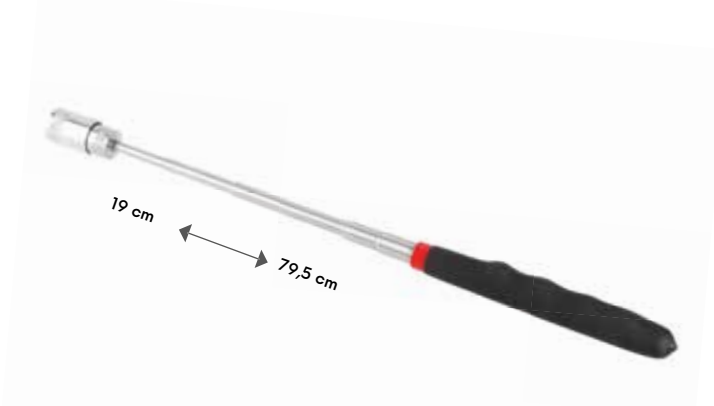

Č.p. specifikace

13294

6

ZRCÁTKO INSPEKČNÍ TELESKOPICKÉ

TELESKOP MAGNETICKÝ

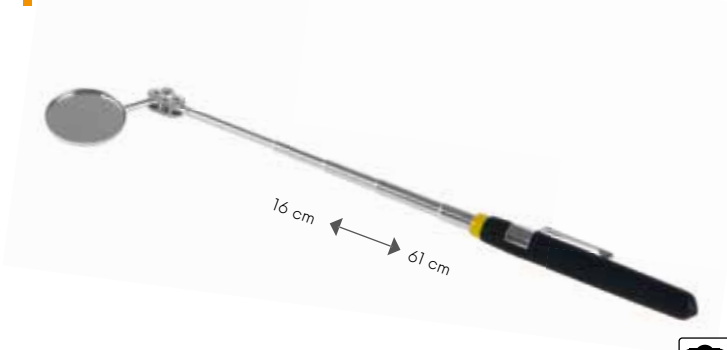

Č.p. specifikace

13290

20

Č.p. specifikace

13293

20

FESTA®

- Dřík z kvalitní S2 oceli
- Magnetické koncovky
- Ergonomická dvoukomponentní rukojeť s měkčenou TPE gumou



ŠROUBOVÁK PLOCHÝ

FESTA®



S2



Č.p.	specifikace	
18113	3 x 75 mm	12
18114	4 x 100 mm	12
18115	5,5 x 125 mm	12
18116	6,5 x 150 mm	12
18118	8 x 175 mm	6
18120	10 x 200 mm	6

ŠROUBOVÁK PLOCHÝ KRÁTKÝ

FESTA®



S2



Č.p.	specifikace	
18124	5,5 x 38 mm	12
18125	6,5 x 38 mm	12

ŠROUBOVÁK PHILIPS

FESTA®



S2



Č.p.	specifikace	
18210	0 x 75 mm	12
18211	1 x 75 mm	12
18212	2 x 100 mm	12

ŠROUBOVÁK PHILIPS KRÁTKÝ

FESTA®



S2



Č.p.	specifikace	
18215	1 x 38 mm	12
18216	2 x 38 mm	12

ŠROUBOVÁK POZIDRIVE

FESTA®



S2



Č.p.	specifikace	
18310	0 x 75 mm	12
18311	1 x 100 mm	12
18312	2 x 100 mm	12
18313	3 x 150 mm	6

ŠROUBOVÁK POZIDRIVE KRÁTKÝ

FESTA®



S2



Č.p.	specifikace	
18321	1 x 38 mm	12
18322	2 x 38 mm	12

ŠROUBOVÁK TORX

FESTA

S2

Č.p.	specifikace	
18350	T6	12
18351	T7	12
18352	T8	12
18353	T9	12
18354	T10	12
18355	T15	12

NÁSTRČNÝ ŠROUBOVÁK

FESTA

CrV

Č.p.	specifikace	
18455	6 mm	12
18456	7 mm	12
18460	13 mm	12

ŠROUBOVÁK ÚDEROVÝ PLOCHÝ

FESTA

CrV

Č.p.	specifikace	
18062	5,5 x 100 mm	12
18063	7 x 125 mm	6
18064	8 x 150 mm	8

VDE ŠROUBOVÁK ELEKTRO PLOCHÝ

FESTA

1000 V
IEC/EN60900

Č.p.	specifikace	
18088	3 x 75 mm S2	12
18089	4 x 100 mm CrV	12
18090	5,5 x 125 mm CrV	12
18091	6,5 x 150 mm CrV	12
18092	8 x 175 mm CrV	12

ŠROUBOVÁK ÚDEROVÝ PHILIPS

FESTA

CrV

Č.p.	specifikace	
18070	PH 1 x 80 mm	8
18071	PH 2 x 100 mm	12
18072	PH 3 x 150 mm	6

VDE ŠROUBOVÁK ELEKTRO PHILIPS

FESTA

1000 V
IEC/EN60900

Č.p.	specifikace	
18080	PH 0 x 60 mm S2	12
18081	PH 1 x 80 mm CrV	12
18082	PH 2 x 100 mm CrV	12
18083	PH 3 x 150 mm CrV	12

ŠROUBOVÁK ÚDEROVÝ POZIDRIVE

FESTA

CrV

Č.p.	specifikace	
18075	PZ 1 x 80 mm	12
18076	PZ 2 x 100 mm	12
18077	PZ 3 x 150 mm	6

VDE ŠROUBOVÁK ELEKTRO POZIDRIVE

FESTA

1000 V
IEC/EN60900

Č.p.	specifikace	
18084	PZ 0 x 60 mm S2	12
18085	PZ 1 x 80 mm CrV	12
18086	PZ 2 x 100 mm CrV	12
18087	PZ 3 x 150 mm CrV	12

SADA ŠROUBOVÁKŮ

FESTA

S2



7x



- ⊖ S 3x75 · 5x100 · 6x175 mm
- ⊕ PH 0 · 1 · 2 · 3

Č.p. specifikace

18402



6

SADA ŠROUBOVÁKŮ

FESTA

S2



6x



- ⊖ S 3x75 · 5x100 · 6x150 mm
- ⊕ PH 0 · 1 · 2

Č.p. specifikace

18403



6

SADA ŠROUBOVÁKŮ

FESTA

S2



6x



- ⊖ S 3x60 · 6x100 · 6x125 mm
- ⊕ PZ 0 · 1 · 2

Č.p. specifikace

18404



6

SADA ŠROUBOVÁKŮ TORX

FESTA

S2



5x



- ⊕ T 10 · 15 · 20 · 25 · 30

Č.p. specifikace

18340



6

SADA ŠROUBOVÁKŮ A BITŮ

FESTA

S2



27x



- ⊖ S 3 x 75 · 4x100 · 5,5x125 · 6,5 x 150 mm
- ⊕ PH 1 x 100 · 2 x 100 mm
- adapter 1/4"

bity:

- ⊖ S 4 · 5 · 6 · 7
- ⊕ PH 1 · 2 · 3
- ⊕ PZ 1 · 2 · 3
- ⊕ T 10 · 15 · 20 · 25 · 30
- ⊕ H 2 · 3 · 4 · 5 · 6

Č.p. specifikace

18422 27 ks



6

SADA ŠROUBOVÁKŮ

FESTA

CrV



18x



- ⊖ S 6x38 · 5x75 · 6x100 · 8x150 mm
- 2,5x50 · S 3x50 mm

- ⊕ PH 2x38 · 1x75 · 2x100 · 3x150 mm
- 0x50 · 00x50 mm

- ⊕ T 5x50 · 6x50 · 7x50 · 8x50 · 9x50 · 10x50 mm

Č.p. specifikace

18424



6

SADA ÚDEROVÝCH ŠROUBOVÁKŮ



CrV

6x



⊖ S 5 · 6 · 8 mm

⊕ PH 1 · 2 · 3

Č.p. specifikace

18423



10

SADA ELEKTRO ŠROUBOVÁKŮ



6x



⚠ 1000 V ⚠
IEC/EN60900

⊖ S 4x100 · 5,5x125 mm · elektro zkoušečka 0 - 250 V

⊕ PH 0x60 · 1x80 · 2x100 mm

Č.p. specifikace

18413



6

ŠROUBOVÁK ÚDEROVÝ



CrV

6x



⊖ S 7 x 35 · 8 x 35 · 8 x 70 mm

⊕ PH 2 x 35 · 3 x 35 · 3 x 70 mm

Č.p. specifikace

18411



1

SADA ELEKTRO ŠROUBOVÁKŮ



7x



⚠ 1000 V ⚠
IEC/EN60900:2004

⊖ S 4x100 · 5,5x125 · 6,5x150 mm · elektro zkoušečka 0 - 250 V

⊕ PH 0x75 · 1x100 · 2x100 mm

Č.p. specifikace

18410



40

OTVÍRÁK



Č.p. specifikace

18437



5

ELEKTRO ZKOUŠEČKA

DIN VDE 0680
73/23 EEC



Č.p. specifikace
18426 0 - 250 V



1

ŠROUBOVÁK PLOCHÝ



Č.p.	specifikace	
18101	3,5 x 75 mm	10
18102	4 x 100 mm	10
18103	5,5 x 100 mm	10
18104	5,5 x 125 mm	10
18105	6,5 x 100 mm	10
18106	6,5 x 125 mm	10
18107	8 x 160 mm	10
18108	10 x 160 mm	10



SADA ŠROUBOVÁKŮ A BITŮ



— S 3x75 · 4x75 · 6x100 · 8x150 mm

+ PH 1x75 · 2x100 mm

○ adapter 1/4"

bity: — S 4 · 5 · 6 · 7 mm

+ PH 1 · 2 · 3

✱ PZ 1 · 2 · 3

⊕ T 10 · 15 · 20

○ ↔ □ adapter

Č.p. specifikace

18418



10

ŠROUBOVÁK PHILIPS



Č.p.	specifikace	
18201	0 x 75 mm	10
18202	1 x 75 mm	10
18203	2 x 100 mm	10
18204	3 x 150 mm	10



SADA ŠROUBOVÁKŮ



— S 3x60 · 4x75 · 6x100 · 6x125 mm

+ PH 0x60 · 1x75 · 2x100 mm

Č.p. specifikace

18400



10

ŠROUBOVÁK POZIDRIVE



Č.p.	specifikace	
18301	0 x 75 mm	10
18302	1 x 75 mm	10
18303	2 x 100 mm	10
18304	3 x 150 mm	10



SADA ŠROUBOVÁKŮ



— S 3x60 · 6x100 · 6x125 mm

+ PH 1x75 · 2x100 mm

Č.p. specifikace

18401



50



T ŠROUBOVÁK NA BITY S RÁČNOU

FESTRA

- 1/4"
- CrV
-



Č.p. 18608 specifikace



ŠROUBOVÁK NA BITY

FESTRA

- 1/4"
-



Č.p. 18110 specifikace



ŠROUBOVÁK NA BITY S RÁČNOU

FESTRA

- 1/4"
- CrV
-



Č.p. 18433 specifikace



ŠROUBOVÁK NA BITY + 7 BITŮ

FESTRA

- 1/4"
- CrV
-



- S 5 · 6 mm
 - PH 1 · 2 · 3
 - T 15 · 20
- Č.p. 18425 specifikace



FLEXI ŠROUBOVÁK NA BITY

FESTRA

- 1/4"



Č.p. 18451 specifikace



FLEXI ŠROUBOVÁK NA HADICOVÉ SPONY

FESTRA

-



Č.p. 18450 specifikace 7 mm



ÚHLOVÝ NÁSTAVEC NA BITY 90°

- 1/4"
-



Č.p. 18910



RÁČNA NA BITY

- 1/4"
- NYLON
-



Č.p. 18435 specifikace 93 mm



ŠROUBOVÁK RÁČNOVÝ S BITY

FESTA

1/4" CrV 45x

1/4" → 1/4"

- ⊖ S 3 · 4 · 5 · 6 · 7 · 5 L
- ⊕ PH 1 · 2 · 3 · 1 L · 2 L
- ⊗ PZ 1 · 2 · 3 · 1 L · 2 L
- ⊙ H 2 · 2.5 · 3 · 4 · 5 · 6
- ⊛ T 10 · 15 · 20 · 25 · 27 · 30
- ⊚ SQ 0 · 1 · 2 · 3
- 1/4" 5 · 6 · 7 · 8 · 9 · 10 · 11 · 12 · 13 mm



6

Č.p. specifikace

18419

T ŠROUBOVÁK + 20 NÁSTAVCŮ

FESTA

1/4"



20x

- ⊖ S 3 · 4 · 5 · 6 · 8 mm
- ⊕ PH 0 · 1 · 2 · 3
- adapter + 5 · 6 · 7 · 8 · 9 · 10 · 11 · 12 · 13 mm



5

Č.p. specifikace

18420

SADA MINI ŠROUBOVÁKŮ

FESTA

CrV



6x

- ⊖ S 1,5x50 · 2x50 · 2,5x50 mm
- ⊕ PH 000x50 · 00x50 · 0x50 mm



6

Č.p. specifikace

18416

SADA MINI ŠROUBOVÁKŮ TORX

FESTA

CrV



7x

- ⊛ T 4 · 5 · 6 · 7 · 8 · 9 · 10x50 mm



6

Č.p. specifikace

18417

ŠROUBOVÁK S MINI BITY

FESTA

CrV

50x



- ⊖ S 1.5 · 2 · 2.5 · 3 · 3.5 mm
- ⊕ PH 000 · 00 · 0 · 1
- ⊗ PZ 0 · 1
- ⊛ T 5 · 6 · 7 · 8 · 9 · 10 · 15 · 20
- ⊙ H 0.9 · 1.3 · 2.0 · 2.5 · 3.0 · 4.0



6

Č.p. specifikace

18431

SADA MINI ELEKTRO ŠROUBOVÁKŮ

FESTA

6x

- ⊖ S 2,4 · 3,0 mm
- ⊕ PH 0 · 1
- ⊛ T 6 · 8



10

Č.p. specifikace

18415

ŠROUBOVÁKY HODINÁŘSKÉ



6x HOBBY

- ⊖ S 1,4 · 2,0 · 2,4 · 3,0 mm
- ⊕ PH 0 · 1



10

Č.p. specifikace

18408

ŠROUBOVÁKY HODINÁŘSKÉ



11x HOBBY

- ⊖ S 1,0 · 1,2 · 1,4 · 1,8 · 2,4 · 3,0 mm
- ⊕ PH 00 · 0 · 1



48

Č.p. specifikace

18409

Stahlberg

bity - profesionální šroubovací nástavce z vysoce legované oceli S2



Výrobce STAHLBERG

Značka světového výrobce šroubovacích nástavců s mnohaletými zkušenostmi v oboru a se zákazníky po celém světě. Při výrobě používá nejnovější technologie, nejlepší dosud vyvinuté materiály a povrchové úpravy.



Technologie výroby

křížové a ploché šroubovací nástavce jsou vyráběny speciální technologií přesného kování. Ta umožňuje dosažení vysoké přesnosti tvaru a současně zvýšení pevnosti oproti obráběným bitům až o 20 %. Po kování jsou bity kaleny pro získání optimální tvrdosti a houževnatosti.

TiN vrstva

vrstva nitridu titanu nanášená na povrch šroubovacího hrotu maximálně zvyšuje tvrdost povrchu, otěruvzdornost a třecí vlastnosti zabráňující vysmeknutí ze záběru.



Diamantová zrna

na povrchu hrotu se doslova „zakousnou“ do hlavy vrtu či šroubu a udrží bit v záběru pro přenos maximálního utahovacího momentu. Jsou nejlepší zárukou setrvání v záběru. Nejčastěji se šroubovací bit totiž poškodí při vysmeknutí ze záběru. Kroučící moment se v tu chvíli přenáší na minimální plochu, která se deformuje.



Protismykové drážky

na pracovních plochách šroubovacích hrotů vyrobených kováním jsou další velmi účinnou obranou proti vysmeknutí hrotu ze záběru.





BIT PH DIAMANT

+

DIN 3128

S2 TiN

MOQ 5

Č.p.	specifikace	
18770	PH1 x 25 mm	5
18771	PH2 x 25 mm	5
18772	PH3 x 25 mm	5

BIT PZ DIAMANT

DIN 3128

S2 TiN

MOQ 5

Č.p.	specifikace	
18775	PZ1 x 25 mm	5
18776	PZ2 x 25 mm	5
18777	PZ3 x 25 mm	5

BIT PH

+

S2

MOQ 5

Č.p.	specifikace	
18630	PH0 x 25 mm	5
18631	PH1 x 25 mm	5
18632	PH2 x 25 mm	5
18633	PH3 x 25 mm	5
18634	PH4 x 25 mm	5

BIT PZ

S2

MOQ 5

Č.p.	specifikace	
18635	PZ0 x 25 mm	5
18636	PZ1 x 25 mm	5
18637	PZ2 x 25 mm	5
18638	PZ3 x 25 mm	5
18639	PZ4 x 25 mm	5

BIT PH

+

S2

MOQ 5

Č.p.	specifikace	
18685	PH2 x 25 mm	5

BIT PZ

S2

MOQ 5

Č.p.	specifikace	
18680	PZ2 x 25 mm	5

BIT PH

+

S2

MOQ 10

Č.p.	specifikace	
18640	PH1 x 70 mm	10
18641	PH2 x 70 mm	10

BIT PZ

S2

MOQ 10

Č.p.	specifikace	
18645	PZ1 x 70 mm	10
18646	PZ2 x 70 mm	10

BIT PH

+

S2 TiN

MOQ 5

Č.p.	specifikace	
18760	PH0 x 25 mm	5
18761	PH1 x 25 mm	5
18762	PH2 x 25 mm	5
18763	PH3 x 25 mm	5
18764	PH4 x 25 mm	1 5

BIT PZ

S2 TiN

MOQ 5

Č.p.	specifikace	
18765	PZ0 x 25 mm	5
18766	PZ1 x 25 mm	5
18767	PZ2 x 25 mm	5
18768	PZ3 x 25 mm	5
18769	PZ4 x 25 mm	5

BIT S

—

S2

MOQ 5

Č.p.	specifikace	
18620	S 3 x 25 mm	5
18621	S 4 x 25 mm	5
18623	S 5 x 25 mm	5
18625	S 6 x 25 mm	5
18627	S 7 x 25 mm	5
18628	S 8 x 25 mm	5

BIT S

—

S2 TiN

MOQ 5

Č.p.	specifikace	
18750	S 3 x 25 mm	5
18751	S 4 x 25 mm	5
18753	S 5 x 25 mm	5
18755	S 6 x 25 mm	5

BIT H



S2

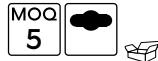

Č.p.	specifikace	
18800	H 1,5 x 25 mm	5
18801	H 2,0 x 25 mm	5
18802	H 2,5 x 25 mm	5
18803	H 3,0 x 25 mm	5
18804	H 4,0 x 25 mm	5
18805	H 5,0 x 25 mm	5
18806	H 5,5 x 25 mm	5
18807	H 6,0 x 25 mm	5

BIT HTA



S2



Č.p.	specifikace	
18810	HTa 1,5 x 25 mm	5
18811	HTa 2,0 x 25 mm	5
18812	HTa 2,5 x 25 mm	5
18813	HTa 3,0 x 25 mm	5
18814	HTa 4,0 x 25 mm	5
18815	HTa 5,0 x 25 mm	5
18816	HTa 5,5 x 25 mm	5
18817	HTa 6,0 x 25 mm	5

BIT T



S2

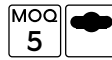

Č.p.	specifikace	
18820	T5 x 25 mm	5
18821	T6 x 25 mm	5
18822	T7 x 25 mm	5
18823	T8 x 25 mm	5
18824	T9 x 25 mm	5
18825	T10 x 25 mm	5
18826	T15 x 25 mm	5
18827	T20 x 25 mm	5
18828	T25 x 25 mm	5
18829	T27 x 25 mm	5
18830	T30 x 25 mm	5
18831	T40 x 25 mm	5
18832	T45 x 25 mm	5

BIT T



S2



Č.p.	specifikace		Č.p.	specifikace	
17980	T30 x 35 mm	3	17982	T45 x 35 mm	3
17981	T40 x 35 mm	3	17983	T50 x 35 mm	3

BIT TTA



S2

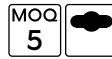

Č.p.	specifikace	
18835	TTa 5 x 25 mm	10
18836	TTa 6 x 25 mm	5
18837	TTa 7 x 25 mm	5
18838	TTa 8 x 25 mm	5
18839	TTa 9 x 25 mm	5
18840	TTa 10 x 25 mm	5
18841	TTa 15 x 25 mm	5
18842	TTa 20 x 25 mm	5
18843	TTa 25 x 25 mm	5
18844	TTa 27 x 25 mm	5
18845	TTa 30 x 25 mm	5
18846	TTa 40 x 25 mm	5
18847	TTa 45 x 25 mm	5

BIT T



S2



Č.p.	specifikace		Č.p.	specifikace	
17970	T20 x 75 mm	3	17972	T30 x 75 mm	3
17971	T25 x 75 mm	3	17973	T40 x 75 mm	3
			17974	T45 x 75 mm	3
			17975	T50 x 75 mm	3
			17976	T55 x 75 mm	3

BIT SD



S2



Č.p.	specifikace	
18855	SD 6 x 25 mm	5
18856	SD 8 x 25 mm	5

BIT TW



S2



Č.p.	specifikace	
18860	TW 1 x 25 mm	5
18861	TW 2 x 25 mm	5
18862	TW 3 x 25 mm	5
18863	TW 4 x 25 mm	5

BIT SQ



S2



Č.p.	specifikace	
18850	SQ 0 x 25 mm	5
18851	SQ 1 x 25 mm	5
18852	SQ 2 x 25 mm	5
18853	SQ 3 x 25 mm	5

BIT



S2



Č.p.	specifikace	
18866	5/32 x 25 mm	5
18867	3/16 x 25 mm	5

BIT TS



S2



Č.p.	specifikace	
18864	TS 4 x 25 mm	5
18865	TS 6 x 25 mm	5

BIT XZN



S2



Č.p.	specifikace	MOQ
18870	M4 x 25 mm	5
18871	M5 x 25 mm	5
18872	M6 x 25 mm	5
18873	M8 x 25 mm	5
18874	M10 x 25 mm	5

MOQ
5



BIT NA SÁDROKARTON



S2

2x



18795



18796

Č.p.	specifikace	MOQ
18795	PH 2 x 25 mm	24
18796	PH 2 x 55 mm	24



BIT



S2



1/4" ↔ 1/4"

Č.p.	specifikace	MOQ
18868	25 mm	5
18869	50 mm	5

MOQ
5



ADAPTER RÁČNA 1/4' - BIT



CrV



1/4" ↔ 1/4"

Č.p.	specifikace	MOQ
18619		5

MOQ
5



NÁSTAVEC NA BITY



1/4"



Č.p.	specifikace	MOQ
18600	1/4' x 60 mm	5

MOQ
5



NÁSTAVEC NA BITY



1/4"



Č.p.	specifikace	MOQ
18797	1/4' x 60 mm	1



NÁSTAVEC NA BITY



1/4"



Č.p.	specifikace	MOQ
18601	1/4' x 60 mm	5

MOQ
5



NÁSTAVEC NA BITY



1/4"



Č.p.	specifikace	MOQ
18798	1/4' x 60 mm	1



NÁSTAVEC NA BITY



1/4"



Č.p.	specifikace	MOQ
18602	1/4' x 60 mm	5

MOQ
5



NÁSTAVEC NA BITY



1/4"



Č.p.	specifikace	MOQ
18799	1/4' x 60 mm	1



NÁSTAVEC NA BITY ODPRUŽENÝ



1/4"



Č.p.	specifikace	MOQ
18609	1/4' x 70 mm	1



NÁSTAVEC NA BITY VODÍCÍ



1/4"



Č.p.	specifikace	MOQ
18607	80 mm	25



ADAPTER 1/4"



Č.p.	specifikace		Č.p.	specifikace	
18610	6 mm	5	18613	10 mm	5
18611	7 mm	5	18614	12 mm	5
18612	8 mm	5	18615	13 mm	5

ADAPTER - SADA



Č.p.	specifikace	
18618	6, 7, 8, 9, 10, 11, 12, 13 mm	12

SADA BITŮ A ADAPTÉRŮ



- 10x ⊕ 18630 PH0
- 10x ⊕ 18631 PH1
- 10x ⊕ 18632 PH2
- 10x ⊕ 18633 PH3
- 10x ⊕ 18635 PZ0
- 10x ⊕ 18636 PZ1
- 10x ⊕ 18637 PZ2
- 10x ⊕ 18638 PZ3
- 10x ⊕ 18761 PH1 TiN
- 10x ⊕ 18762 PH2 TiN
- 10x ⊕ 18763 PH3 TiN
- 10x ⊕ 18766 PZ1 TiN
- 10x ⊕ 18767 PZ2 TiN
- 10x ⊕ 18768 PZ3 TiN
- 10x ⊕ 18770 PH1 DIAMANT
- 10x ⊕ 18771 PH2 DIAMANT
- 10x ⊕ 18775 PZ1 DIAMANT
- 10x ⊕ 18776 PZ2 DIAMANT
- 10x ⊙ 18814 4,0HTa
- 10x ⊙ 18815 5,0HTa
- 10x ⊙ 18842 20TTa
- 10x ⊙ 18845 30TTa
- 10x ⊕ 18795 PH2 na sádrokarton
- 5x 18612 adapter 1/4" 8mm
- 5x 18613 adapter 1/4" 10mm
- 5x 18600 nástavec magnetický 1/4" 60mm
- 5x 18601 nástavec magnetický, rychloupínací 1/4" 60mm
- 5x 18602 nástavec magnetický, s dorazem 1/4" 65mm



Č.p.	specifikace
18993	



SADA BITŮ

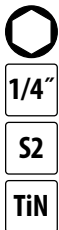

- 10x ⊕ 18631 PH1
- 10x ⊕ 18632 PH2
- 10x ⊕ 18633 PH3
- 10x ⊕ 18636 PZ1
- 10x ⊕ 18637 PZ2
- 10x ⊕ 18638 PZ3
- 10x ⊕ 18761 PH1 TiN
- 10x ⊕ 18762 PH2 TiN
- 10x ⊕ 18763 PH3 TiN
- 10x ⊕ 18766 PZ1 TiN
- 10x ⊕ 18767 PZ2 TiN
- 10x ⊕ 18768 PZ3 TiN
- 10x ⊙ 18804 H 4
- 10x ⊙ 18805 H 5
- 10x ⊙ 18825 T 10
- 10x ⊙ 18826 T 15
- 10x ⊙ 18827 T 20
- 10x ⊙ 18828 T 25
- 10x ⊙ 18830 T 30
- 10x ⊙ 18831 T 40

Č.p.	specifikace
18994	



SADA BITŮ

FESTA



1/4"

S2



32x

· magnetický rychloupínací nástavec na bity



- ⊖ S 3 · 4 · 5 · 6
- ⊕ PH 1 · 2 · 3
- ✱ PZ 1 · 2 · 3
- H 3 · 4 · 5 · 6
- ⊛ T 10 · 15 · 20 · 25 · 27 · 30 · 40
- ⊛ TTa 10 · 15 · 20 · 25 · 27 · 30 · 40

Č.p. specifikace

18905



10

SADA BITŮ

FESTA



1/4"

S2



57x

· magnetický rychloupínací nástavec na bity



- ⊖ S 4 · 5 · 6
- ⊕ PH 1 · 2 · 3
- ✱ PZ 1 · 2 · 3
- H 3 · 4 · 5 · 6
- ⊛ T 10 · 15 · 20 · 25 · 27 · 30 · 40
- ⊛ TTa 10 · 15 · 20 · 25 · 27 · 30 · 40

Č.p. specifikace

18906



6

SADA BITŮ

FESTA



1/4"

S2

33x



- ⊙ HTa 2 · 2.5 · 3 · 4 · 5 · 6
5/32" · 9/64" · 1/8"
7/64" · 3/32" · 5/64"

⊙ SD 4 · 6 · 8 · 10

⊕ TS 6 · 8 · 10

⊕ TW 1 · 2 · 3 · 4

⊛ TTa 8 · 10 · 15 · 20 · 25 · 27 · 30 · 35 · 40

magnetický nástavec na bity

Č.p. specifikace

18900



10

SADA BITŮ

FESTA



1/4"

S2

33x



⊖ S 3 · 4 · 5 · 6 · 7

⊕ PH 0 · 1 · 2 · 3

✱ PZ 1 · 2 · 3

● H 2 · 2.5 · 3 · 4 · 5 · 6

⊛ T 10 · 15 · 20 · 25 · 30 · 40

magnetický nástavec na bity

Č.p. specifikace

18901



10

SADA BITŮ

FESTA



1/4"

S2



100x



- ⊖ S 3 · 4 · 4.5 · 5 · 5.5 · 6 · 6.5 · 7 · 8
- ⊕ PH 0 · 1 · 2 · 3
- ✱ PZ 0 · 1 · 2 · 3
- ⊙ SQ 0 · 1 · 2 · 3
- ⊛ T 8 · 10 · 15 · 20 · 25 · 27 · 30 · 40 · 45
- ⊛ TTa 8 · 10 · 15 · 20 · 25 · 27 · 30 · 35 · 40
- H 1.5 · 2 · 2.5 · 3 · 4 · 5 · 5.5 · 6 · 8 mm
1/16" · 5/64" · 3/32" · 7/64" · 1/8" · 9/64"
5/32" · 3/16" · 7/32" · 1/4"
- ⊙ HTa 2 · 2.5 · 3 · 4 · 5 · 6 mm
5/64" · 3/32" · 7/64" · 1/8" · 9/64" · 5/32"
- ⊙ SD 4 · 6 · 8 · 10
- ⊕ TS 6 · 8 · 10
- ⊕ TW 1 · 2 · 3 · 4
- ⊕ 2-wing 1 · 2 · 3
- XZN 5 · 6 · 8

magnetický nástavec na bity

nástavec „Y“

1/4" DR nástavec na šroubovák

1/4" bit adapter: 25mm, 50mm

Č.p. specifikace

18909



24

SADA BITŮ

S2

20x

- ⊖ S 4 · 5 · 6 · 7
- ⊕ PH 1 · 2 · 3
- ⊛ PZ 1 · 2 · 3
- H 4 · 5 · 6
- ⊛ T 10 · 15 · 20 · 25
- SQ 1 · 2 · 3



Č.p. specifikace

18907



10

SADA BITŮ

CrV

TiN

10x

- ⊖ S 4 · 5 · 6 · 7
- ⊕ PH 1 · 2 · 3
- ⊛ PZ 1 · 2 · 3



Č.p. specifikace

18440



10

SADA BITŮ

HOBBY

7x

- ⊖ S 3 · 5 · 7
- ⊕ PH 1 · 2 · 3

magnetický nástavec na bity



Č.p. specifikace

18430



20

SADA BITŮ A NÁSTAVCŮ

1/4"

CrV

HOBBY

41x

- ⊖ S 3 · 4 · 4,5 · 5 · 5,5 · 6 · 7
- ⊕ PH 1 · 2 · 3
- ⊛ PZ 1 · 2 · 3
- H 2 · 3 · 4 · 5
- ⊛ T 20 · 30
- 1/4" 4 · 4,5 · 5 · 5,5 · 6 · 7 · 8 · 9 · 10
- 5/32" · 3/16" · 7/32" · 1/4" · 9/32" · 5/16" · 11/32" · 3/8" · 7/16"

magnetický šroubovák
nástavec na bity
2 ks adapter

Č.p. specifikace

18916



10

SADA BITŮ A NÁSTAVCŮ

CrV

1/4"

HOBBY

40x

- ⊖ S 3 · 3,5 · 4 · 5,5
- ⊕ PH 0 · 1 · 2 · 3
- ⊛ PZ 0 · 1 · 2 · 3
- H 3 · 4
- ⊛ T 10 · 15 · 20 · 25 · 27 · 30
- 1/4" 4 · 4,5 · 5 · 5,5 · 6 · 7 · 8 · 9 · 10 · 11 · 13

nástavec na šroubovák 1/4"
magnetický nástavec na bity

Č.p. specifikace

18915



10

SADA NÁŘADÍ

1/4"

CrV

23x

Č.p. specifikace

18421



- ⊖ S 5 · 6 mm
- ⊕ PH 1 · 2
- H 3 · 4 · 5 · 6
- ⊛ T 15 · 20 · 25 · 30
- 1/4" 4 · 5 · 6 · 7 · 8 · 9 · 10 · 12 · 13 mm
- 75 mm 1/4"
- 1/4" → 1/4"



10

SADA NÁŘADÍ

35x

Č.p. specifikace

17260



- 120mm
- 125mm
- 115mm
- 150mm max. 19mm
- 9mm
- 1/4" 160mm
- 5 · 6 · 7 · 8 · 9 · 10 · 11 mm
- 1/4"
- 1/4"
- ⊖ S 4 · 6 mm
- ⊕ PH 1 · 2 · 3
- ⊛ PZ 1 · 2
- H 4 · 5 · 6



10

SADA NÁŘADÍ

FESTA
NEW
CrV
S2
1/4"
1/2"
72T
122x

- 1/2", 1/4"
- 1/4" · 4-5-6-7-8-9mm
- 1/2" · 10-12-13-14-17-19mm
- 1/4" · 4-4.5-5-5.5-6-7-8-9-10-11-12-13-14mm
- 1/2" · 12-13-14-15-16-17-18-19-20-21-22-24mm
- 1/2", 1/4"
- 1/4" · → 1/4"
- 1/4" · 150mm
- 1/2" · 254mm
- 1/2", 1/4"
- 1/2" · 16-21mm
- 1/4" · 150mm
- 1/2" · E10-E12-E14-E16-E18-E20-E22-E24
- 1/4" · S 3 · 4 · 5 · 6
- 1/4" · PH 0 · 1 · 2
- 1/4" · PZ 0 · 1 · 2
- 1/4" · S 4 · 5,5 · 6,5
- 1/4" · PH 1 · 2 · 3
- 1/4" · PZ 2 · 3
- 1/4" · H 3 · 4 · 5 · 6
- 1/4" · T 8 · 10 · 15 · 20 · 25
- 1/4" · TTa 10 · 15 · 20 · 25 · 40
- 2 · 2,5 · 3 · 4 · 5 · 6 · 7 · 8 · 10mm
- 8-9-10-11-12-13-14-15-16-17-18-19mm
- S 4x100 · 6,5x150
- PH 2x100 · 3x150
- 180mm
- 160mm
- 160mm
- 250mm
- 300g



Č.p. specifikace

17238 122 ks

1

SADA NÁŘADÍ

60x

- 160 mm
- 160 mm
- 300 g
- 1/4" 45T
- 4 · 5 · 6 · 7 · 8 · 9 · 10 · 11 · 12 · 13 mm
- 1/4" 75 mm
- 1,5 · 2 · 2,5 · 3 · 4 · 5 · 6 · 8 · 10 mm
- S 3 · 4 · 5 · 6 mm
- PH 0 · 1 · 2 · 3
- PZ 0 · 1 · 2 · 3
- T 10 · 15 · 20 · 25
- H 3 · 4 · 5 · 6
- S 5x100 mm
- PH 1x100 · 2x100 mm
- S 2,5x50 mm
- PH 00x50 · 0x50 mm
- AC 100-250 V
- 200 mm max. 22 mm
- 10x11 · 12x13 · 14x15 · 16x17 mm
- 18 mm
- 2 m | 13 mm



Č.p. specifikace

17259

5

SADA NÁŘADÍ

32x

- 1/4" 5 · 6 · 7 · 8 · 9 · 10 · 11 · 12 mm
- 1/4"
- 1/4"
- AC 230 V
- PH 0, SL 3
- 9x 1,5-10 mm
- 160 mm
- S 3 · 4 · 5 · 6 mm
- PH 0 · 1 · 2 · 3
- H 4 · 5
- PH 2x100, S 6x100
- 18 mm
- 1 m
- 300 g



Č.p. specifikace

17247

10

SADA INBUSŮ

FESTA



CrV

9x

- H 1,5 mm
- H 2 mm
- H 2,5 mm
- H 3 mm
- H 4 mm
- H 5 mm
- H 6 mm
- H 8 mm
- H 10 mm



Č.p. specifikace

18496

5

SADA INBUSŮ S HLAVIČKOU

FESTA



CrV

9x

- H 1,5 mm
- H 2 mm
- H 2,5 mm
- H 3 mm
- H 4 mm
- H 5 mm
- H 6 mm
- H 8 mm
- H 10 mm



Č.p. specifikace

18500

5

SADA INBUSŮ - PRODLOUŽENÉ

FESTA



CrV

9x

- H 1,5 mm
- H 2 mm
- H 2,5 mm
- H 3 mm
- H 4 mm
- H 5 mm
- H 6 mm
- H 8 mm
- H 10 mm



Č.p. specifikace

18490

5

SADA INBUSŮ S HLAVIČKOU

FESTA



CrV

9x

- H 1,5 mm
- H 2 mm
- H 2,5 mm
- H 3 mm
- H 4 mm
- H 5 mm
- H 6 mm
- H 8 mm
- H 10 mm



Č.p. specifikace

18498

5

SADA INBUSŮ S HLAVIČKOU

FESTA



CrV

9x

- 1/16"
- 5/64"
- 3/32"
- 1/8"
- 5/32"
- 3/16"
- 1/4"
- 5/16"
- 3/8"



Č.p. specifikace

18493

6

SADA KLÍČŮ TORX

FESTA



CrV

9x

- T 10 mm
- T 15 mm
- T 20 mm
- T 25 mm
- T 27 mm
- T 30 mm
- T 40 mm
- T 45 mm
- T 50 mm



Č.p. specifikace

18497

5

SADA INBUSŮ S HLAVIČKOU - PRODLOUŽENÉ

FESTA



CrV

9x

- H 1,5 mm
- H 2 mm
- H 2,5 mm
- H 3 mm
- H 4 mm
- H 5 mm
- H 6 mm
- H 8 mm
- H 10 mm



Č.p. specifikace

18492

10

SADA KLÍČŮ TORX - PRODLOUŽENÉ

FESTA



CrV

9x

- T 10 mm
- T 15 mm
- T 20 mm
- T 25 mm
- T 27 mm
- T 30 mm
- T 40 mm
- T 45 mm
- T 50 mm



Č.p. specifikace

18491

5

KLÍČ INBUS - STANDARD

FESTA
DIN 911

CrV

Č.p.	specifikace		
18540	1,5 mm	14 x 45 mm	1
18541	2 mm	16 x 50 mm	1
18542	2,5 mm	18 x 56 mm	1
18543	3 mm	20 x 63 mm	1
18544	4 mm	25 x 70 mm	1
18545	5 mm	28 x 80 mm	1
18546	6 mm	32 x 90 mm	1
18547	7 mm	34 x 95 mm	1
18548	8 mm	36 x 100 mm	1
18549	9 mm	38 x 105 mm	1
18550	10 mm	40 x 112 mm	1
18551	11 mm	42 x 120 mm	1
18552	12 mm	45 x 125 mm	1
18553	13 mm	50 x 130 mm	1
18554	14 mm	56 x 140 mm	1
18557	17 mm	63 x 160 mm	1
18559	19 mm	70 x 180 mm	1
18562	22 mm	80 x 200 mm	1
18567	27 mm	100 x 250 mm	1
18572	32 mm	125 x 315 mm	1

KLÍČ INBUS S HLAVIČKOU PRODLOUŽENÝ

FESTA

CrV

Č.p.	specifikace		
18575	1,5 mm	15 x 75 mm	1
18576	2 mm	17 x 81 mm	1
18577	2,5 mm	18 x 87 mm	1
18578	3 mm	20 x 96 mm	1
18579	4 mm	24 x 107 mm	1
18580	5 mm	30 x 120 mm	1
18581	6 mm	33 x 136 mm	1
18582	7 mm	34 x 144 mm	1
18583	8 mm	36 x 153 mm	1
18584	9 mm	38 x 155 mm	1
18585	10 mm	40 x 171 mm	1
18586	11 mm	40 x 230 mm	1
18587	12 mm	42 x 250 mm	1
18588	13 mm	45 x 260 mm	1
18589	14 mm	56 x 280 mm	1
18593	17 mm	61 x 290 mm	1

KLÍČ TORX

FESTA

CrV

Č.p.	specifikace	
18466	T7	1
18468	T9	1
18476	T45	1
18477	T50	1

KLÍČ INBUS - PRODLOUŽENÝ

FESTA

CrV

Č.p.	specifikace		
18510	1,5 mm	15 x 75 mm	1
18511	2 mm	17 x 81 mm	1
18512	2,5 mm	18 x 87 mm	1
18513	3 mm	20 x 96 mm	1
18514	4 mm	24 x 107 mm	1
18515	5 mm	30 x 120 mm	1
18516	6 mm	33 x 136 mm	1
18518	8 mm	36 x 153 mm	1
18519	9 mm	38 x 155 mm	1
18520	10 mm	40 x 171 mm	1
18521	11 mm	40 x 230 mm	1
18522	12 mm	42 x 250 mm	1
18523	13 mm	45 x 260 mm	1
18524	14 mm	56 x 280 mm	1
18527	17 mm	61 x 290 mm	1

SADA INBUSŮ

FESTA

CrV

Č.p.	specifikace	
18508	1,5 · 2 · 2,5 · 3 · 4 · 5 · 6 mm	1

NÁSTRČNÝ T - KLÍČ INBUS SADA

FESTA



CrV

9x



2 mm
2,5 mm
3 mm
4 mm
5 mm
6 mm
7 mm
8 mm
10 mm



Č.p. specifikace

18494

6

NÁSTRČNÝ T - KLÍČ TORX SADA

FESTA



CrV

9x



T 10
T 15
T 20
T 25
T 27
T 30
T 40
T 45
T 50



Č.p. specifikace

18495

6

SADA INBUSŮ



8x

HOBBY



Č.p. specifikace

18499 2 · 2,5 · 3 · 4 · 5 · 6 · 8 · 10 mm



1

KLÍČ NÁSTRČNÝ T - TORX

FESTA



CrV





Č.p.	specifikace	
17350	T 7	10
17351	T 8	10
17352	T 9	10
17353	T 10	10

Č.p.	specifikace	
17357	T 27	10
17359	T 40	10
17360	T 45	10
17361	T 50	10



FESTA**KLADIVA a PALICE****KLADIVO****FESTA****DIN
1041**

· jasanová násada

Č.p.	specifikace		Č.p.	specifikace	
19081	100 g	1	19086	600 g	1
19082	200 g	1	19088	800 g	1
19083	300 g	1	19090	1000 g	1
19084	400 g	1	19092	1500 g	1
19085	500 g	1	19095	2000 g	1

PALICE**FESTA****DIN
1041**

· jasanová násada

Č.p.	specifikace		Č.p.	specifikace	
19096	3000 g	1	19106	6000 g	1
19097	4000 g	1	19108	8000 g	1
19098	5000 g	1	19109	10000 g	1

PALICE**FESTA****DIN
6475**

· jasanová násada

Č.p.	specifikace	
19074	5000 g	1
19075	6000 g	1
19076	8000 g	1
19077	10000 g	1

KLADIVO FIBERGLASS



· násada fiberglass

Č.p.	specifikace		Č.p.	specifikace	
19021	100 g	12	19026	600 g	6
19022	200 g	12	19028	800 g	6
19023	300 g	12	19030	1000 g	6
19024	400 g	12	19031	1500 g	6
19025	500 g	12	19032	2000 g	1

PALICE FIBERGLASS



DIN 6475



· násada fiberglass

Č.p.	specifikace		Č.p.	specifikace	
19066	1000 g	4	19070	3000 g	4
19067	1250 g	4	19071	4000 g	4
19068	1500 g	4	19058	5000 g	4
19069	2000 g	2	19059	6000 g	2

KLADIVO

DIN 1041



· kruhový klín

Č.p.	specifikace		Č.p.	specifikace	
19001	100 g	12	19006	600 g	6
19002	200 g	12	19008	800 g	6
19003	300 g	6	19010	1000 g	6
19004	400 g	6	19015	1500 g	6
19005	500 g	6	19020	2000 g	6

PALICE

DIN 6475



· kruhový klín

Č.p.	specifikace		Č.p.	specifikace	
19053	1000 g	6	19055	2000 g	6
19050	1250 g	6	19056	3000 g	6
19054	1500 g	6	19057	4000 g	6

PALICE FIBERGLASS



· násada fiberglass

Č.p.	specifikace	
19034	3000 g	4
19036	4000 g	4

KLADIVO ŠEVCOVSKÉ FIBERGLASS



· násada fiberglass

Č.p.	specifikace	
19064	450 g	6

KLADIVO POKRÝVAČSKÉ FIBERGLASS



· násada fiberglass

Č.p.	specifikace	
19061	600 g	6

KLADIVO ZEDNICKÉ FIBERGLASS



· násada fiberglass

Č.p.	specifikace	
19151	600 g	6

KLADIVO ŠEVCOVSKÉ MONOLIT

FESTA



Č.p.	specifikace	
19063	450 g	6

KLADIVO POKRÝVAČSKÉ MONOLIT

FESTA



Č.p.	specifikace	
19062	600 g	6

KLADIVO ZEDNICKÉ MONOLIT

FESTA



Č.p.	specifikace	
19150	600 g	6

KLADIVO POKRÝVAČSKÉ



Č.p.	specifikace	
19100	600 g	6

KLADIVO ŠEVCOVSKÉ

FESTA



Č.p.	specifikace	
19065	600 g	6

KLADIVO POKRÝVAČSKÉ

FESTA



Č.p.	specifikace	
19060	600 g	6

PALICE

FESTA



Č.p.	specifikace	
19051	1000 g	6
19052	1500 g	6

KLADIVO - SEKERA

FESTA



Č.p.	specifikace	
19303	600 g	6

KLADIVO ZEDNICKÉ

FESTA



jasanová násada

Č.p.	specifikace	
19149	44 mm	1

KLADIVO ZEDNICKÉ

FESTA



jasanová násada

Č.p.	specifikace	
19124	24 mm	1
19136	36 mm	1
19148	48 mm	1

KLADIVO SVAŘEČSKÉ



Č.p.	specifikace	
19115	300 g	1

JASANOVÁ NÁSADA NA ZEDNICKÉ KLADIVO

FESTA



Č.p.	specifikace	
61240	násada	1

NÁSADA NA KLADIVO JASANOVÁ



Č.p.	specifikace	pro kladivo		Č.p.	specifikace	pro kladivo	
61320	26 cm	19081	10	61325	33 cm	19086	10
61321	28 cm	19082	10	61326	35 cm	19088	10
61322	30 cm	19083	10	61327	36 cm	19090	10
61323	31 cm	19084	10	61328	38 cm	19092	10
61324	32 cm	19085	10	61329	40 cm	19095	10

NÁSADA NA PALICI JASANOVÁ



Č.p.	specifikace	pro palice	
61330	80 cm	19074, 19075	10
61331	90 cm	19076, 19077	10

KLÍNEK KRUHOVÝ KÓNICKÝ



Č.p.	specifikace	
19430	6 mm	10
19431	8 mm	10
19432	10 mm	10
19433	12 mm	10
19434	14 mm	10
19435	16 mm	10

KLÍNEK KOVANÝ



Č.p.	specifikace	
19440	úzký	10
19441	střední	10
19442	široký	10
19443	široký S	10

KLÍNEK DO TOPORA

FESTA

3x



Č.p.	specifikace	
19398	20 x 25 x 5	1
19399	30 x 40 x 5	1

PALICE DŘEVĚNÁ

FESTA



· bukové dřevo

Č.p.	specifikace		
19202	Ø 60 x 120 mm	350 g	1

PALICE DŘEVĚNÁ

FESTA



· bukové dřevo

Č.p.	specifikace		
19200	80 x 60 mm	520 g	1

PALICE GUMOVÁ

FESTA



· jasanová násada



Č.p.	specifikace		
19245	Ø 55 mm	400 g	1
19246	Ø 60 mm	800 g	1
19247	Ø 70 mm	1000 g	1
19248	Ø 95 mm	2000 g	1
19249	Ø 115 mm	3000 g	1

PALICE GUMOVÁ

FESTA



· násada fiberglass



Č.p.	specifikace		
19270	Ø 55 mm		6
19271	Ø 65 mm		6
19272	Ø 90 mm		6

PALICE GUMOVÁ

FESTA



Č.p.	specifikace		
19255	Ø 55 mm		6
19265	Ø 65 mm		6
19290	Ø 90 mm		6

PALICE GUMOVÁ BÍLÁ

FESTA



Č.p.	specifikace		
19294	Ø 65 mm		6
19295	Ø 90 mm		6

PALICE GUMOVÁ ČERNO-BÍLÁ



Č.p.	specifikace		
19254	Ø 65 mm		6

PALICE GUMOVÁ



Č.p.	specifikace	
19251	Ø 55 mm 400 g	12
19252	Ø 65 mm 700 g	6
19253	Ø 90 mm 1300 g	4

PALICE SILIKONOVÁ



Č.p.	specifikace	
19297	Ø 35 mm	12

PALIČKA S VÝMĚNNÝMI KONCI

NEW



Č.p.	specifikace	
19208	Ø 40 mm	1

PALICE MOSAZNÁ



· násada fiberglass

Č.p.	specifikace	
19211	Ø 30 mm 500 g	1

PALICE NYLONOVÁ



· násada fiberglass

Č.p.	specifikace	
19209	Ø 34 mm	6

TPU - 95 Shore A ·	PP - 97 Shore A ·
TPE - 90 Shore A ·	TPE - 90 Shore A ·
TPU - 92 Shore A ·	TPU - 92 Shore A ·
TPE - 90 Shore A ·	TPU - 88 Shore A ·

Č.p.	specifikace	
19208	Ø 40 mm	1

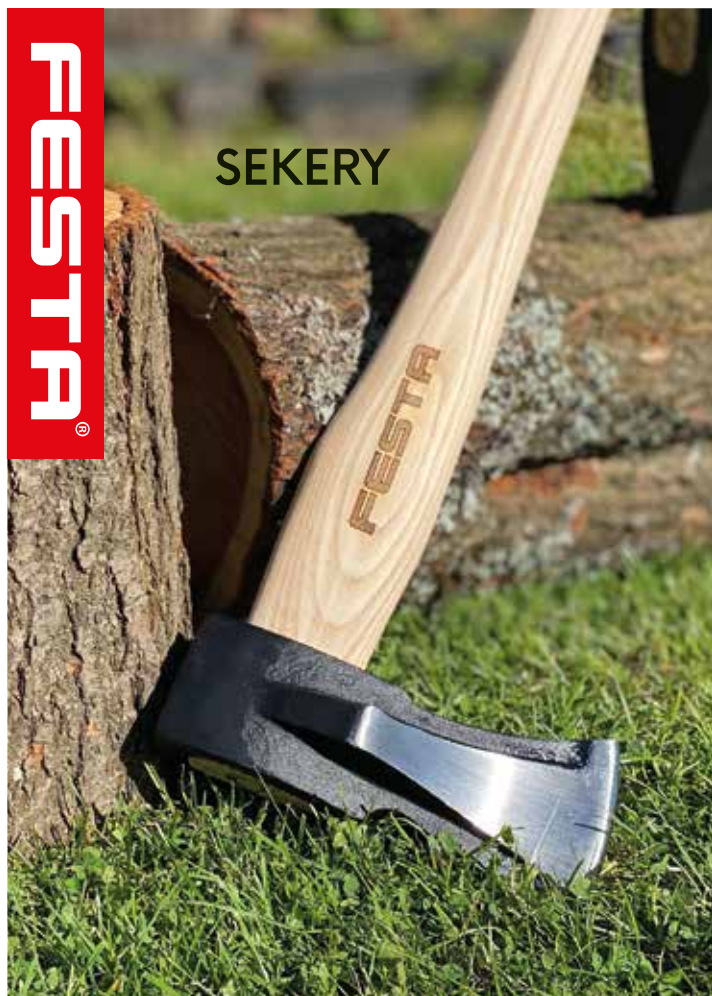

SEKERY

FESTA

SEKERA

FESTA

DIN 5131

DIN 7294



- jasanová násada
- kruhový klín

Č.p.	specifikace		Č.p.	specifikace	
19380	600 g	1	19384	1400 g	1
19381	800 g	1	19385	1600 g	1
19382	1000 g	1	19387	2000 g	1
19383	1250 g	1			

SEKERA TESAŘSKÁ

FESTA



- jasanová násada

Č.p.	specifikace	
19340	700 g	22

KALAČ

FESTA

DIN 5129



- jasanová násada
- kruhový klín

Č.p.	specifikace	
19389	3000 g	1
19388	4000 g	1

SEKERA ŠTÍPACÍ

FESTA

DIN 7294



- jasanová násada
- kruhový klín

Č.p.	specifikace	
19391	2000 g	1

SEKERA

NÁSADA NA SEKERU JASANOVÁ



Č.p.	specifikace	
19306	600 g	24
19308	800 g	24
19310	1000 g	24
19312	1250 g	12
19314	1500 g	12

Č.p.	specifikace	pro kladivo	
61340	36 cm	19380	10
61341	40 cm	19381, 19340	10
61342	50 cm	19382	10
61343	70 cm	19383, 19384	10

Č.p.	specifikace	pro kladivo	
61344	80 cm	19385, 19391	10
61345	90 cm	19387	10
61346	90 cm	19388, 19389	10

SEKERA FIBERGLASS



SEKERA CAMP FIBERGLASS



· násada fiberglass

Č.p.	specifikace	
19326	600 g	6
19328	800 g	24
19330	1000 g	12

Č.p.	specifikace	
19332	1250 g	8
19335	1600 g	6
19337	2000 g	6

· násada fiberglass

Č.p.	specifikace	
19301	500 g	6

SEKERA ŠTÍPACÍ FIBERGLASS



SEKERA ŠTÍPACÍ FIBERGLASS



· násada fiberglass

Č.p.	specifikace	
19392	1000 g	6

· násada fiberglass

Č.p.	specifikace	
19390	2000 g	6

KALAČ FIBERGLASS



SEKERA FIBERGLASS



· násada fiberglass

Č.p.	specifikace	
19370	3000 g	4
19371	4000 g	4

· násada fiberglass

Č.p.	specifikace	
19344	1250 g	6

SEKERA



SEKERA ŠTÍPACÍ



Č.p.	specifikace	
19354	600 g	6
19356	1200 g	5
19357	1800 g	1

Č.p.	specifikace	
19360	2700 g štípací	6

KLÍN ŠTÍPACÍ TORZNÍ



Č.p.	specifikace	
19397	2000 g 55 x 210 x 45 mm	10
19465	2500 g 65 x 230 x 45 mm	10

KLÍN ŠTÍPACÍ ČTYŘRAMENNÝ



Č.p.	specifikace	
19469	2500 g 165 x 87 mm	10

KLÍN ŠTÍPACÍ



Č.p.	specifikace	
19394	1000 g 35 x 180 x 40 mm	6
19395	2000 g 40 x 255 x 55 mm	6
19396	2500 g 40 x 260 x 55 mm	8

KLÍN ROZEVÍRACÍ NYLONOVÝ



Č.p.	specifikace	
19462	175 x 65 x 20 mm	1
19463	230 x 70 x 30 mm	1
19464	240 x 75 x 40 mm	1

FESTA®



PÁČIDLO



PÁČIDLO

14 mm

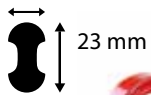

Č.p.	specifikace	
19424	400 mm	6
19425	600 mm	6
19426	800 mm	6
19427	1000 mm	6



Č.p.	specifikace	
19416	600 mm Ø 16 mm	4
19422	800 mm Ø 16 mm	4
19421	1000 mm Ø 18 mm	4

PÁČIDLO

NEW



Č.p.	specifikace	
19423	380 x 35 x 6 mm	1

VYTAHOVÁK PÁČIDLO



Č.p.	specifikace	
19415	300 mm Ø 15 mm	6

SEKÁČ PLOCHÝ

FESTA

CrV



Č.p.	specifikace	šířka hrotu	
19406	300 mm	25 mm	5
19407	400 mm	30 mm	5

SEKÁČ ŠPIČATÝ

FESTA

CrV



Č.p.	specifikace	
19408	250 mm	5
19409	350 mm	5

SEKÁČ PLOCHÝ

FESTA

CrV



Č.p.	specifikace	šířka hrotu	
19460	300 mm	25 mm	5
19470	400 mm	30 mm	5

SEKÁČ ŠPIČATÝ



Č.p.	specifikace	
19400	250 mm	5
19403	350 mm	6

SEKÁČ PLOCHÝ



Č.p.	specifikace	šířka hrotu	
19401	250 mm	19 mm	6
19404	350 mm	22 mm	6

SEKÁČ PLOCHÝ



Č.p.	specifikace	šířka hrotu	
19402	250 mm	50 mm	2
19405	350 mm	50 mm	6

SEKÁČ PLOCHÝ

FESTA

CrV



Č.p.	specifikace	šířka hrotu	
19410	200 mm	20 mm	10
19411	250 mm	25 mm	10
19412	300 mm	25 mm	10
19418	400 mm	25 mm	5
19419	500 mm	25 mm	5

SEKÁČ ZÁMEČNICKÝ PLOCHÝ

CrV



Č.p.	specifikace	šířka hrotu	
19436	200 mm	20 mm	15



DLÁTA

FESTA®

SADA DLÁT S BROUSKEM

FESTA
CrV 5x

- 6 mm
- 10 mm
- 15 mm
- 20 mm
- 25 mm



Č.p. specifikace

19451



10

SADA DLÁT

FESTA
CrV 4x

- 6 mm
- 12 mm
- 19 mm
- 25 mm



Č.p. specifikace

19457



10

DLÁTO

FESTA
CrV

Č.p.	specifikace		Č.p.	specifikace	
19490	6 mm 275 mm	6	19496	18 mm 280 mm	6
19491	8 mm 275 mm	6	19497	20 mm 280 mm	6
19492	10 mm 275 mm	6	19498	22 mm 280 mm	6
19493	12 mm 275 mm	6	19499	25 mm 280 mm	6
19494	14 mm 275 mm	6	19501	32 mm 290 mm	6
19495	16 mm 275 mm	6	19502	38 mm 290 mm	6

DLÁTO TRUHLÁŘSKÉ MULTIFUNKČNÍ

FESTA
INOX

Č.p. specifikace

16231 20 | 80 mm



12

SADA DLÁT

4x

- 8 mm
- 12 mm
- 19 mm
- 25 mm



Č.p. specifikace

19450



20

SADA DLÁT

4x

- 8 mm
- 12 mm
- 19 mm
- 25 mm



Č.p. specifikace

19455



30

SADA SOUSTRUŽNICKÝCH DLÁT

FESTA

HOBLÍK - KLOPKAŘ



CrV

8x



Č.p.	specifikace
19510	220 x 65 x 130 mm, nůž 48 mm



HOBLÍK - HLADÍK



Č.p.	specifikace
19515	200 x 55 x 130 mm, nůž 39 mm



SADA ŘEZBÁŘSKÝCH DLÁT

CrV

12x



Č.p.	specifikace
19458	365 125mm



HOBLÍK - ŘÍMSOVNÍK



Č.p.	specifikace
19520	225 x 27 x 155 mm, nůž 27 mm



SADA KLEMPÍŘSKÁ

7x



Č.p.	specifikace
19110	







FESTA®



SPONKOVAČKY

SPONKOVAČKA 5 V 1







-  | 6 - 14 mm
23960 - 23964
23760 - 23764,
23906 - 23914
-  | 10 - 14 mm
23965
-  | 15 mm
23966
-  | 15 mm
23967

Č.p. specifikace
23927

 6

SPONKOVAČKA 4 V 1



-  | 6 - 14 mm
23960 - 23964
-  | 12 mm
23965
-  | 14 mm
23966
-  | 14 mm
23967





Č.p. specifikace
23924

 12

SPONKOVAČKA 3 V 1



-  | 6 - 14 mm
23960 - 23964
-  | 14 mm
23966
-  | 14 mm
23967



Č.p. specifikace
23923

 12

SPONKOVAČKA



-  53 | 4 - 14 mm
23904 - 23914,
23760 - 23765



Č.p. specifikace
23925 4 - 14 mm s aretací

 20

ODSTRAŇOVAČ SPON



Č.p. specifikace
23945



 25

SPONKOVAČKA



53 | 4 - 14 mm
23760 - 23765,
23904 - 23914

Č.p.	specifikace	
23800		20

SPONKOVAČKA

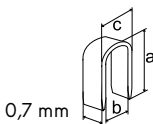
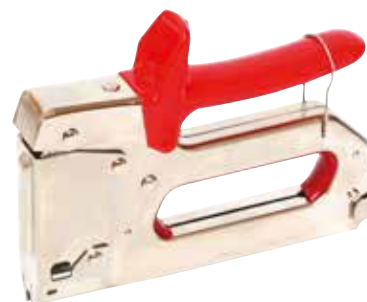

53 | $\alpha=9-11$ mm, $b=5,5$ mm, $c=6,4$ mm

Č.p.	specifikace	
23920		4

KLADIVO SPONKOVACÍ

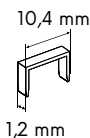

53 | 6 - 10 mm
23960 - 23962

Č.p.	specifikace	
23922		10

KLADIVO SPONKOVACÍ

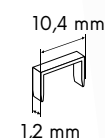

53 | 6 - 10 mm
23960 - 23962

Č.p.	specifikace	
23928		6

SPONY EXTRA

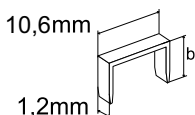

Č.p.	specifikace	
23960	b=6 mm, 1000 ks	50
23961	b=8 mm, 1000 ks	50
23962	b=10 mm, 1000 ks	50
23963	b=12 mm, 1000 ks	50
23964	b=14 mm, 1000 ks	50

SPONY

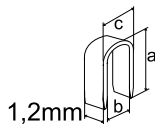

Č.p.	specifikace	
23965	$\alpha=12$ mm, $b=6,5$ mm, $c=7,5$ mm, 1000 TW	50

HŘEBÍKY



Č.p.	specifikace	
23966	hřebíky nails 14 mm 1000 TW	100

HŘEBÍKY



Č.p.	specifikace	
23967	hřeby nails 14 mm 1000 TW	100

SPONY - TYP 53

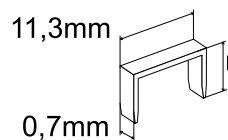

Č.p.	specifikace	
23904	b=4 mm 1000 ks	200
23906	b=6 mm 1000 ks	200
23908	b=8 mm 1000 ks	200
23910	b=10 mm 1000 ks	200
23912	b=12 mm 1000 ks	200
23914	b=14 mm 1000 ks	200

SPONY - TYP 53

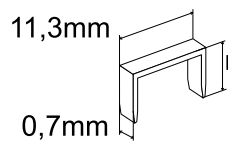

Č.p.	specifikace	
23760	b=4 mm 2000 ks	10
23761	b=6 mm 2000 ks	10
23762	b=8 mm 2000 ks	10
23763	b=10 mm 2000 ks	10
23764	b=12 mm 2000 ks	10

KLADIVO SPONKOVACÍ



140 | 6 - 10 mm
24535-24537,
24540-24542,
24567

Č.p. specifikace
24510



KLADIVO SPONKOVACÍ



13 | 4 - 6 mm
24530
24533

Č.p. specifikace
24511



SPONKOVAČKA



140 | 6 - 14 mm
24535-24539,
24540-24543,
24567

Č.p. specifikace
24515



SPONKOVAČKA



140 | 6 - 8 mm
24535-24536,
24540-24541,
24567

Č.p. specifikace
24516



SPONKOVAČKA



13 | 4 - 10 mm
24530 - 24534

Č.p. specifikace
24520



SPONKOVAČKA



53 | 6 - 14 mm
24545 - 24547,
24555 - 24558,
24551 - 24552,
24568 - 24569

8 | 15 mm
24570

Č.p. specifikace
24517



SPONKOVAČKA

Rapid

SPONKOVAČKA

Rapid



53

| 6 - 14 mm
24545 - 24547,
24555 - 24558,
24551 - 24552,
24568 - 24569



Č.p. specifikace

24518



20



13

| 4 - 8 mm
24530 - 24531,
24533 - 24534



Č.p. specifikace

24521



20



SPONKOVAČKA

Rapid

SPONKOVAČKA

Rapid



53

| 6 - 12 mm
24545 - 24547,
24555 - 24557,
24551 - 24551,
24568 - 24569



Č.p. specifikace

24522



20



7

| 12 - 14 mm
24570



8

| 15 mm
24570



9

| 15 mm
24570



53

| 4 - 10 mm
24550,
24545 - 24547,
24555 - 24557



Č.p. specifikace

24519



20

SPONY HIGH PERFORMANCE - TYP 53

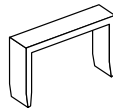

Č.p.	délka	blistr ks	
24550	4 mm	1620	10
24545	6 mm	2130	10
24555	6 mm	5000	10
24546	8 mm	2130	10
24556	8 mm	5000	10
24547	10 mm	2130	10
24557	10 mm	5000	10
24551	12 mm	1080	10
24558	12 mm	5000	10
24552	14 mm	1080	10
24553	20 mm	540	10

SPONY HIGH PERFORMANCE - TYP 13

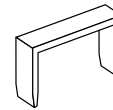

Č.p.	délka	blistr ks	
24530	6 mm	1650	10
24533	6 mm	5000	10
24531	8 mm	1650	10
24534	8 mm	5000	10
24532	10 mm	1100	10

SPONY NEREZ - TYP 53 INOX



INOX

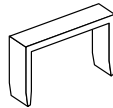

Č.p.	délka	blistr ks	
24568	6 mm	1080	10
24569	8 mm	1080	10

SPONY HIGH PERFORMANCE - TYP 140

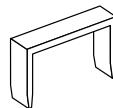

Č.p.	délka	blistr ks	
24535	6 mm	970	10
24540	6 mm	5000	10
24536	8 mm	970	10
24541	8 mm	5000	10
24537	10 mm	648	10
24542	10 mm	5000	10
24538	12 mm	648	10
24543	12 mm	5000	10
24539	14 mm	648	10

SPONY NEREZ - TYP 140 INOX



INOX

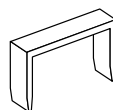

Č.p.	délka	blistr ks	
24567	10 mm	650	10

SPONY HIGH PERFORMANCE - TYP 606

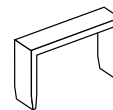

Č.p.	délka	blistr ks	
24560	12 mm	1200	10
24561	18 mm	600	10
24562	25 mm	600	10

SPONY HIGH PERFORMANCE - TYP 90

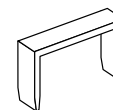

Č.p.	délka	blistr ks	
24580	20 mm	3000	10
24581	25 mm	3000	10
24582	30 mm	3000	10
24583	35 mm	1500	10
24584	40 mm	1500	10



SPONY HIGH PERFORMANCE - TYP 8



Č.p.	délka	blistr ks	
24570	15 mm	1000	10
24571	20 mm	750	10
24572	25 mm	1000	10
24573	30 mm	1000	10
24577	40 mm	2800	10
24578	50 mm	2800	10

SPONY NEREZ - TYP 8 INOX



INOX



Č.p.	délka	blistr ks	
24575	30 mm	4200	10

SPONY HIGH PERFORMANCE - TYP 7

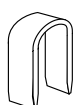

Č.p.	délka	blistr ks	
24565	14 mm	960	10

SPONY HIGH PERFORMANCE - TYP 9



Č.p.	délka	blistr ks	
24574	15 mm	1000	10



HŘEBÍKY NASTŘELOVACÍ - TYP F

NEW

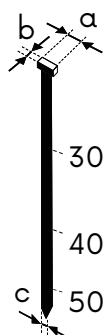

a 2,0 mm
b 1,25 mm
c 0,95 mm

SPONY NASTŘELOVACÍ

NEW

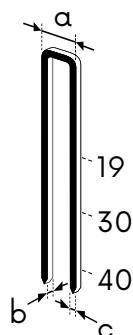

a 5,7 mm
b 1,25 mm
c 0,95 mm

pro AKU hřebíkovačku 28070

Č.p.	specifikace	
23930	30 mm - 6000 ks	1
23931	40 mm - 6000 ks	1
23932	50 mm - 6000 ks	1

pro AKU hřebíkovačku 28070

Č.p.	specifikace	
23934	19 mm - 3000 ks	1
23935	30 mm - 3000 ks	1
23936	40 mm - 3000 ks	1



SVĚRKY A SVĚŘÁKY

SVĚRKA RYCHLOUPÍNACÍ

FESTA

· kovaná

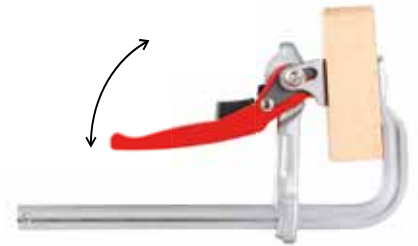

Č.p.	specifikace		Č.p.	specifikace	
23560	200 x 80 mm	1	23564	600 x 120 mm	1
23561	300 x 100 mm	1	23565	800 x 120 mm	1
23562	400 x 100 mm	1	23566	1000 x 120 mm	1
23563	500 x 120 mm	1			

SVĚRKA RYCHLOUPÍNACÍ

FESTA

NEW

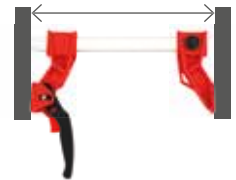

Č.p.	specifikace	
23570	100 x 80 mm	1
23571	160 x 80 mm	1
23572	200 x 80 mm	1
23573	250 x 80 mm	1
23574	300 x 80 mm	1

ZTUŽIDLO TRUHLÁŘSKÉ

FESTA



Č.p.	specifikace		Č.p.	specifikace		Č.p.	specifikace	
23670	150 x 105 mm	1	23676	500 x 175 mm	1	23682	1500 x 175 mm	1
23671	200 x 105 mm	1	23677	600 x 175 mm	1	23683	1750 x 175 mm	1
23672	250 x 105 mm	1	23678	700 x 175 mm	1	23684	2000 x 175 mm	1
23673	300 x 105 mm	1	23679	800 x 175 mm	1	23685	2200 x 175 mm	1
23674	350 x 105 mm	1	23680	1000 x 175 mm	1			
23675	400 x 175 mm	1	23681	1250 x 175 mm	1			

SVĚRKA

DIN 5117



Č.p.	specifikace	
23506	300 x 120 mm	10
23507	500 x 120 mm	10
23508	800 x 120 mm	6

SVĚRKA



Č.p.	specifikace		Č.p.	specifikace	
23515	150 x 50 mm	50	23530	300 x 50 mm	50
23520	200 x 50 mm	50	23531	300 x 120 mm	20
23525	250 x 50 mm	50	23551	500 x 120 mm	10

SVĚRKA RYCHLOUPÍNACÍ

FESTA



Č.p.	specifikace	
23625	200 mm	6
23626	300 mm	6
23628	450 mm	6
23630	600 mm	6
23632	760 mm	6

SVĚRKA RYCHLOUPÍNACÍ

FESTA



Č.p.	specifikace	
23585	150 mm	6
23587	300 mm	6
23589	450 mm	6
23591	600 mm	6

SVĚRKA SE ZUBOVOU POJISTKOU

SVĚRKA PLASTOVÁ

G' SVĚRKY SADA

3x



rozeč 80 mm | span 80 mm

Č.p.	specifikace	
23605	9' 230 mm	6



Č.p.	specifikace	
23600	4', rozeč 40 mm	20
23601	6', rozeč 50 mm	12
23602	9', rozeč 80 mm	20



Č.p.	specifikace	
23620	25 mm, 50 mm, 75 mm	10

SVĚRÁK

FESTA

SVĚRÁK OTOČNÝ

tvrzené čelisti

tvrzené čelisti



Č.p.	specifikace	
23410	100 mm	1
23411	125 mm	1
23412	150 mm	1



Č.p.	specifikace	
23415	100 mm	1
23416	125 mm	1
23417	150 mm	1

SVĚRÁK OTOČNÝ



Č.p.	specifikace
23407	65 mm

10

SVĚRKA ROHOVÁ 90°

ALU



· rozsah 0 - 65 mm

Č.p.	specifikace
23420	65 mm

20

STŮL PRACOVNÍ

· ideální do sklepních kójí



Č.p.	specifikace
23660	

1

SVĚRÁK POD VRTAČKU



· tvrzené čelisti

Č.p.	specifikace
23400	18 80 mm
23401	22 100 mm
23402	24 125 mm

10

10

5

SVĚRÁK MODELÁŘSKÝ OTOČNÝ 360° STOLNÍ

ALU



Č.p.	specifikace
23406	80 mm

24

STŮL PRACOVNÍ MULTIFUNKČNÍ



Č.p.	specifikace
23650	

1

FESTA®

KLEŠTĚ NÝTOVACÍ

KLEŠTĚ NÝTOVACÍ

FESTA®
Cr-Mo

Ø 2,4 mm

 Ø 3,2 mm

 Ø 4,0 mm

 Ø 4,8 mm

Č.p. specifikace

 24007 200 mm



1



KLEŠTĚ NÝTOVACÍ

FESTA®
Cr-Mo

Ø 2,4 mm

 Ø 3,2 mm

 Ø 4,0 mm

 Ø 4,8 mm

Č.p. specifikace

 24010 250 mm



12



KLEŠTĚ NÝTOVACÍ **FESTA**

Cr-Mo

INOX ALU Cu

Ø 2,4 mm
Ø 3,0 mm
Ø 3,2 mm
Ø 4,0 mm
Ø 4,8 mm

Č.p. specifikace
24017 280 mm

1

KLEŠTĚ NÝTOVACÍ **FESTA**

Cr-Mo

INOX ALU Cu

Ø 2,4 mm
Ø 3,2 mm
Ø 4,0 mm
Ø 4,8 mm
Ø 6,4 mm

Č.p. specifikace
24015 530 mm

1

KLEŠTĚ NÝTOVACÍ **FESTA**

Cr-Mo

ALU Cu

Ø 2,4 mm
Ø 3,0 mm
Ø 3,2 mm
Ø 4,0 mm
Ø 4,8 mm

Č.p. specifikace
24030 260 mm

24

KLEŠTĚ NÝTOVACÍ **FESTA**

Cr-Mo

ALU Cu

· stavitelná hlava kleští
· 2 pozice

Č.p. specifikace
24002 260 mm

6

KLEŠTĚ NÝTOVACÍ **FESTA**

Cr-Mo

ALU Cu

Ø 2,4 mm
Ø 3,2 mm
Ø 4,0 mm
Ø 4,8 mm

Č.p. specifikace
24006 250 mm

12

KLEŠTĚ NÝTOVACÍ + NÝTY

Cr-Mo

ALU Cu

Ø 2,4 x 6 mm
Ø 3,2 x 6 mm
Ø 4,0 x 6 mm
Ø 4,8 x 6 mm

Č.p. specifikace
24005 260 mm

5

KLEŠTĚ NÝTOVACÍ S OTOČNOU HLAVOU **FESTA**

ALU Cu

Cr-Mo

Č.p. specifikace
24020 290 mm

8

KLEŠTĚ NÝTOVACÍ PEVNÉ

ALU

Č.p. specifikace
24001 260 mm

6

KLEŠTĚ NÝTOVACÍ

ALU

Č.p. specifikace
24000 250 mm

24

KLEŠTĚ NÝTOVACÍ PRO NÝTOVACÍ MATICE

FESTA®

Cr-Mo



- M3
- M4
- M5
- M6
- M8
- M10



Č.p. specifikace
24036 330 mm



1

KLEŠTĚ NÝTOVACÍ PRO NÝTOVACÍ MATICE

FESTA®

Cr-Mo



- M3
- M4
- M5
- M6



Č.p. specifikace
24035 200 mm



1

HLAVICE DO NÝTOVACÍCH KLEŠTÍ PRO NÝTOVACÍ MATICE

Cr-Mo

FESTA®



- vhodné pro 24035, 24036



Č.p.	specifikace	
24038	M3	1
24039	M4	1
24040	M5	1
24041	M6	1
24042	M8	1
24043	M10	1

MATICE NÝTOVACÍ, 20 KS

ALU

20x



Č.p.	specifikace	
23950	M3 x 9 mm	20
23951	M4 x 11 mm	20
23952	M5 x 12 mm	50
23953	M6 x 14 mm	50
23954	M8 x 16,5 mm	25
23955	M10 x 18 mm	20

NÝTY HLINÍKOVÉ TRHACÍ

ALU

50x



Č.p.	specifikace	
23970	3,2 x 6 mm	25
23971	3,2 x 8 mm	25
23972	3,2 x 10 mm	25
23973	3,2 x 12 mm	25
23974	3,2 x 14 mm	25
23975	4,0 x 6 mm	25
23976	4,0 x 8 mm	25
23977	4,0 x 10 mm	25
23978	4,0 x 12 mm	25
23979	4,0 x 14 mm	25
23985	4,8 x 6 mm	25
23986	4,8 x 8 mm	25
23987	4,8 x 10 mm	25
23988	4,8 x 12 mm	25
23989	4,8 x 14 mm	25



KLEŠTĚ SPOJOVACÍ NA PROFILY PERFORAČNÍ



Č.p.	specifikace
17187	350 mm

KLEŠTĚ SPOJOVACÍ NA PROFILY PERFORAČNÍ



Č.p.	specifikace
17188	250 mm

KLEŠTĚ NA HMOŽDINKY



Č.p.	specifikace
17189	255 mm

STAHOVÁK NA LOŽISKA - DVOURAMENNÝ

STAHOVÁK NA LOŽISKA - TŘÍRAMENNÝ



Č.p.	max. průměr	hloubka
23734	Ø 100 mm	50-95 mm
23735	Ø 150 mm	100-150 mm
23736	Ø 200 mm	110-190 mm



Č.p.	max. průměr	hloubka
23730	Ø 100 mm	50-95 mm
23731	Ø 150 mm	100-150 mm
23732	Ø 200 mm	110-190 mm

SVÁŘECÍ INVERTOR TIG/MMA 160 A

FESTA®



Napětí/frekvence:	230 V / 50 Hz
Napětí naprázdno:	55 V
Regulační rozsah svářecích proudů	10 - 160 A
Průměr elektrody:	1,5 - 4,0 mm
Pracovní cyklus:	TIG- 160 A / 60%, MMA - 140 A / 60%
Třída ochrany:	IP 21
Druh svařování:	TIG/MMA
Rozměry:	405 x 165 x 270 mm
Technologie:	Anti-stick, Arc-force, Hot start, Lift TIG
Hmotnost:	6 kg

Č.p.	specifikace	
70040	Svařovací invertor TIG/MMA 160A	1
70045	Svařovací kabely náhradní	1
70046	Hořák TIG náhradní	1



ELEKTRODA RUTILOVÁ ER 117



certifikované

ELEKTRODA BASICKÁ



certifikované

Č.p.	specifikace	množství		Č.p.	specifikace	množství	
70021	Ø 2,0 x 300 mm	10 ks	1	70030	NEW Ø 2,0 x 300 mm	2,5 kg	1
70020	Ø 2,0 x 300 mm	2,5 kg	8	70031	NEW Ø 2,0 x 300 mm	5 kg	1
70026	Ø 2,5 x 300 mm	10 ks	1	70035	Ø 2,5 x 300 mm	2,5 kg	8
70025	Ø 2,5 x 300 mm	2,5 kg	8	70036	Ø 2,5 x 300 mm	10 ks	1
70033	Ø 3,2 x 350 mm	10 ks	1	70037	Ø 3,2 x 350 mm	5 kg	5
70032	Ø 3,2 x 350 mm	5 kg	4	70038	Ø 3,2 x 350 mm	10 ks	1

KUKLA SAMOSTMÍVACÍ SVÁŘEČSKÁ

CE EN
379



LCD display



Velikost zorného pole:	98 x 80 mm
Rychlost zatmavení filtru:	1/25 000 s
Zatmavení filtru:	DIN 5-8 / 9-13
UV/IR ochrana:	DIN 16
Optická třída:	1 1 1 2
Počet senzorů:	4

Napájení: Solární články + vyměnitelná baterie CR2450

Pracovní režim: Sváření, broušení



Č.p.	specifikace	
70064	aktivní	1
70066	náhradní krycí plexisklo	1

KUKLA SAMOSTMÍVACÍ SVÁŘEČSKÁ - CARBON

2x
CR2032
3V

CARBON

7-15
shade



Č.p.	specifikace	
70063	aktivní	4

KUKLA SAMOSTMÍVACÍ

2x AAA

7-15
shade



Č.p.	specifikace	
70060	aktivní	4

KUKLA SVÁŘEČSKÁ

UV-IR
protection

11
shade



Č.p.	specifikace	
70061		4

BRÝLE SVÁŘEČSKÉ

UV-IR
protection



Č.p.	specifikace	
70062		1

SKLÍČKO NÁHRADNÍ KRYCÍ DO SVÁŘEČSKÉ KUKLY

2x



Č.p.	specifikace	
70065	113 x 80 mm	20

KLADIVO SVÁŘEČSKÉ



Č.p.	specifikace	
19115	300 g	1

DRŽÁK ELEKTRODY



Č.p.	specifikace	
70070	300 A	1

KLEŠTĚ ZEMNÍČÍ



Č.p.	specifikace	
70075	300 A	1

MAGNET ÚHLOVÝ



Č.p.	specifikace	nosnost	
70096	150 x 130 x 30 mm · 45°, 90°, 135°	25 kg	10

MAGNET ÚHLOVÝ



Č.p.	specifikace	nosnost	
70090	85 x 85 mm · 45°, 90°	9 kg	10

MAGNET ÚHLOVÝ



Č.p.	specifikace	nosnost	
70093	95 x 64 mm · 30°, 45°, 60°, 75°, 90°	9 kg	10
70094	120 x 90 mm · 30°, 45°, 60°, 75°, 90°	18 kg	10
70095	137 x 110 mm · 30°, 45°, 60°, 75°, 90°	27 kg	10

MAGNET ÚHLOVÝ



Č.p.	specifikace	nosnost	
70091	95 x 109 x 25 mm · 45°, 90°, 135°	13 kg	10
70092	130 x 150 x 32 mm · 45°, 90°, 135°	22 kg	5

TYČ ZÁVITOVÁ NEREZOVÁ

DIN 976 INOX



4.8 · třída pevnosti

Č.p.	specifikace		
55311	M 5	1 m	150
55313	M 8	1 m	50
55314	M 10	1 m	25
55315	M 12	1 m	20
55316	M 14	1 m	15
55317	M 16	1 m	15
55318	M 18	1 m	10
55319	M 20	1 m	10

TYČ ZÁVITOVÁ

DIN 975 Zn



4.8 · třída pevnosti

Č.p.	specifikace		
55040	M 4	1 m	200
55050	M 5	1 m	150
55060	M 6	1 m	100
55080	M 8	1 m	50
55100	M 10	1 m	20
55120	M 12	1 m	20
55140	M 14	1 m	15
55160	M 16	1 m	15
55180	M 18	1 m	10
55200	M 20	1 m	10
55220	M 22	1 m	5
55240	M 24	1 m	5
55300	M 30	1 m	5

TYČ ZÁVITOVÁ

DIN 975



4.8 · třída pevnosti

Č.p.	specifikace		
55041	M 4	1 m	200
55051	M 5	1 m	150
55101	M 10	1 m	20
55121	M 12	1 m	20
55141	M 14	1 m	15
55181	M 18	1 m	10
55201	M 20	1 m	10
55221	M 22	1 m	5
55301	M 30	1 m	5



MATICE

DIN 934

Zn



4.8 · třída pevnosti

Č.p.	specifikace		
55350	M 4	100 ks	1
55351	M 5	100 ks	1
55352	M 6	100 ks	1
55353	M 8	100 ks	1
55354	M 10	100 ks	1
55355	M 12	100 ks	1
55356	M 14	100 ks	1
55357	M 16	100 ks	1
55358	M 18	100 ks	1
55359	M 20	10 ks	1
55360	M 22	10 ks	1
55361	M 24	10 ks	1
55362	M 30	10 ks	1

PODLOŽKA

DIN 440R

Zn



Č.p.	specifikace		
55331	M 5	100 ks	1
55332	M 6	100 ks	1
55333	M 8	100 ks	1
55334	M 10	100 ks	1
55335	M 12	100 ks	1
55336	M 14	100 ks	1
55337	M 16	100 ks	1
55339	M 20	10 ks	1
55340	M 22	10 ks	1
55341	M 24	10 ks	1
55342	M 30	10 ks	1



KOMPRESOR 6 L - BEZOLEJOVÝ

FESTA



Napětí/frekvence:	230 V / 50Hz
Příkon:	1,2 kW (1,5HP)
Objem nádrže:	6 l
Max. tlak:	8 Bar
Otáčky:	3900 min.
Sací výkon:	180 l/min.
Plnicí výkon:	116 l/min.
Hmotnost:	10 kg

Č.p.

35360



1



KOMPRESOR 24 L - BEZOLEJOVÝ



Výkon:	1100 W
Napájení:	230 V / 50Hz
Běh bez zátěže:	2850 min-1
Pracovní tlak:	8 bar
Volný přívod vzduchu:	160 l / min
Typ:	bezolejový / without oil
Kapacita zásobníka:	24 L
Hmotnost:	23 kg

Č.p.

specifikace

35361 1,1 kW, 24 l



1

KOMPRESOR 24 L



Výkon:	1500 W
Napájení:	230 V / 50Hz
Běh bez zátěže:	2850 min-1
Pracovní tlak:	8 bar
Volný přívod vzduchu:	200 l / min
Typ:	olejový / oleic
Kapacita zásobníka:	24 L
Hmotnost:	24 kg

Č.p.

specifikace

35362 1,5 kW, 24 l



1

KOMPRESOROVÁ SADA

FESTA

5x

- postřikovací pistole se spodním nádržkou
- foukací pistole s nanometrem
- postřikovací pistole s horní nádržkou
- ofukovací pistole
- hadice s rychlospojkami



Č.p. specifikace
48001



KOMPRESOROVÁ SADA

FESTA

3x

- foukací pistole s nanometrem
- ofukovací pistole
- hadice s rychlospojkami



Č.p. specifikace
48002



PISTOLE STRÍKACÍ

FESTA



Č.p. specifikace
48015



PISTOLE NA SPODKY A DUTINY

FESTA



Č.p. specifikace
48036

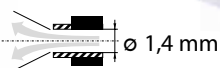

PISTOLE STŘÍKACÍ

FESTA

500 ml



Č.p.	specifikace
48020	horní



PISTOLE STŘÍKACÍ

FESTA

600 ml



Č.p.	specifikace	1
48021	horní	1
48047	náhradní tryska Ø 1,7 mm	1



PISTOLE STŘÍKACÍ

FESTA

1000 ml



Č.p.	specifikace	1
48022	horní	1
48046	náhradní tryska Ø 1,5 mm	1



PISTOLE STŘÍKACÍ

FESTA

600 ml



Č.p.	specifikace
48030	dolní



PISTOLE STŘÍKACÍ NA BARVY A OMÍTKY

NEW



- doporučený tlak 4 - 6 Bar
- objem nádoby 5 l
- průměr trysky 4; 6; 8 mm

Č.p.	specifikace
48037	



PISTOLE OFUKOVACÍ

FESTA



Č.p.	specifikace
48005	krátká



PISTOLE OFUKOVACÍ

FESTA



Č.p.	specifikace
48006	střední



PISTOLE OFUKOVACÍ

FESTA



Č.p.	specifikace
48007	dlouhá



PISTOLE FOUKACÍ S MANOMETREM

FESTA



Č.p.	specifikace
48010	



HADICE TLAKOVÁ S RYCHLOSPOJKAMI

FESTA

NEW



· max. 20 Bar

Č.p.	specifikace			
48031	5 m	ø 9/15 mm		1
48032	10 m	ø 9/15 mm		1
48033	15 m	ø 9/15 mm		1
48034	20 m	ø 9/15 mm		1

HADICE S RYCHLOSPOJKAMI

FESTA



Č.p.	specifikace	světlost	
48043	5 m	8 atm	10 mm



HADICE S RYCHLOSPOJKAMI

FESTA



Č.p.	specifikace	světlost	
48040	5 m	8 atm	8 mm
48041	10 m	8 atm	8 mm
48042	15 m	8 atm	8 mm



FILTR



· maximální tlak 10 bar

Č.p.	specifikace	
48008	G 1/4"	1



REGULÁTOR TLAKU S MANOMETREM



· pracovní tlak 0 - 10 bar

Č.p.	specifikace	
48009	G 1/4"	1



TRYSKA NÁHRADNÍ

FESTA



· vhodné pro 48021

Č.p.	specifikace	
48047	tryska Ø 1,7 mm	1



TRYSKA NÁHRADNÍ

FESTA



· vhodné pro 48022

Č.p.	specifikace	
48046	tryska Ø 1,5 mm	1



TABULKA ROZMĚRŮ TRUBKOVÝCH ZÁVITŮ WHITWORTH

VELIKOST ZÁVITU G V PALCÍCH	MAXIMÁLNÍ VNĚJŠÍ Ø ZÁVITU V MM
1/8	9,728
1/4	13,157
3/8	16,662
1/2	20,955
3/4	26,441
1	33,249

RYCHLOSPOJKA

REDUKCE

ŠROUBENÍ S VNĚJŠÍMI ZÁVITY



Č.p.	specifikace	
48075	1/4' vnější	10
48076	3/8' vnější	10
48077	1/2' vnější	10
48095	1/4' vnitřní	10
48096	3/8' vnitřní	10
48097	1/2' vnitřní	10

Č.p.	specifikace	
48054	3/8' vnější x 1/4' vnitřní	10
48055	1/2' vnější x 3/8' vnitřní	10
48056	redukce 3/8' vnější x 1/2' vnitřní	10
48057	redukce 1/4' vnější x 3/8' vnitřní	10

Č.p.	specifikace	
48050	spojka 1/4' vnější x 1/4' vnější	10
48051	redukce 1/4' vnější x 3/8' vnější	10

RYCHLOSPOJKA / HADICOVÁ VSUVKA

ADAPTÉR RYCHLOSPOJKY / HADICOVÁ VSUVKA





Č.p.	specifikace	
48070	1/4' - 6 mm	10
48071	3/8' - 9 mm	10
48072	1/2' - 13 mm	10

Č.p.	specifikace	
48085	1/4' - 6 mm	10
48086	3/8' - 9 mm	10
48087	1/2' - 13 mm	10

ADAPTÉR RYCHLOSPOJKY

HADICOVÁ VSUVKA

Č.p.	specifikace	
48080	1/4' vnější	10
48081	3/8' vnější	10
48090	3/8' vnitřní	10
48091	1/4' vnitřní	10

Č.p.	specifikace	
48060	Ø 6 mm - 1/8' vnější	10
48061	Ø 6 mm - 1/4' vnější	10
48062	Ø 6 mm - 3/8' vnější	10
48063	Ø 9 mm - 1/4' vnější	10
48064	Ø 9 mm - 3/8' vnější	10
48065	Ø 13 mm - 1/4' vnější	10
48066	Ø 13 mm - 3/8' vnější	10
48067	Ø 6 mm - 3/8' vnitřní	10
48068	Ø 9 mm - 3/8' vnitřní	10
48093	Ø 6 mm - 1/4' vnitřní	10
48094	Ø 9 mm - 1/4' vnitřní	10

OCHRANNÉ
POMŮCKY

BRÝLE ZJASŇUJÍCÍ LASEROVÝ PAPERSEK

CE EN
166

Laserliner®



Č.p.	specifikace	
26021	červené	12

BRÝLE OCHRANNÉ

CE EN
166

Č.p.	specifikace	
50510		10

BRÝLE OCHRANNÉ

CE EN
166

Č.p.	specifikace	
50514		10

BRÝLE OCHRANNÉ

CE EN
166

 nastavitelná délka straniček

Č.p.	specifikace	
50511		12

BRÝLE OCHRANNÉ

CE EN
170

Č.p.	specifikace	
50512	tmavé	12

BRÝLE OCHRANNÉ

CE EN
166

Č.p.	specifikace	
50513		1

SLUCHÁTKA OCHRANNÁ

CE EN 352

27 dB



Č.p. specifikace
50563

1

SLUCHÁTKA OCHRANNÁ

CE EN 352

27 dB



Č.p. specifikace
50564

1

ŠTÍT OCHRANNÝ PE

CE EN 166



Č.p. specifikace
50556

10

PŘILBA OCHRANNÁ CLIMAX

CE EN 397



Č.p.	specifikace
50550	modrá
50551	červená
50553	bílá
50554	žlutá



30
30
30
30

ŠTÍT OCHRANNÝ S MŘÍŽKOU

CE EN 1731



Č.p.
50562

10

VESTA REFLEXNÍ

CE EN 20471



Č.p.	specifikace
50570	oranžová
50571	žlutá



100
100

ZÁTKY DO UŠÍ



Č.p. specifikace
50560

100

ZÁTKY DO UŠÍ NA ŠNŮRCE



Č.p. specifikace
50559

100

RESPIRÁTOR

CE EN
149



Č.p.	specifikace	
50500	FFP2 bez ventilu	30
50501	FFP1 bez ventilu	30

RESPIRÁTOR

CE EN
149



Č.p.	specifikace	
50502	FFP1 s ventilem	20
50503	FFP2 s ventilem	20

ROUŠKA - ÚSTENKA

50x



Č.p.	specifikace	
50505		40

MOQ
40



RUKAVICE KOŽENÉ, ZESÍLENÉ

CE EN
166



S podšívkou v dlani



Č.p.	specifikace	
50518	velikost 11"	12

RUKAVICE KOŽENÉ, ZESÍLENÉ

CE EN
388



S podšívkou v dlani



Č.p.	specifikace	
50519	velikost 10,5"	12

RUKAVICE KOŽENÉ

CE EN
388



Č.p.	specifikace	
50520	velikost 10,5"	12

RUKAVICE KOŽENÉ

CE EN
388



Č.p.	specifikace	
50521	velikost 10,5"	12

RUKAVICE KOŽENÉ, S TEPLOU PODŠÍVKOU

CE EN
388



Č.p.	specifikace	
50523	velikost 11"	12

BAVLNĚNÉ RUKAVICE S PVC TERČÍKY



Č.p.	specifikace	
50524	velikost 10"	12

UKAVICE BAVLNĚNÉ MÁČENÉ V PVC
**CE EN
388**

Č.p.	specifikace	
50525	velikost 10" - délka 35 cm	12

UKAVICE POLYESTER S PVC TERČÍKY

· S PVC terčíky



Č.p.	specifikace	
50526	velikost 10"	12

UKAVICE BAVLNĚNÉ MÁČENÉ V LATEXU
**CE EN
388**

Č.p.	specifikace	
50522	velikost 10"	12

UKAVICE NYLONOVÉ MÁČENÉ V NITRILU
**CE EN
388**

Č.p.	specifikace	
50533	velikost 10"	12

UKAVICE NYLON MÁČENÉ V LATEXOVÉ PĚŇĚ
**CE EN
388**

Č.p.	specifikace	
50537	velikost 10"	12

UKAVICE NYLON MÁČENÉ V NITRILOVÉ PĚŇĚ
**CE EN
388**

Č.p.	specifikace	
50539	velikost 10"	12

UKAVICE ZIMNÍ AKRYLOVÉ, MÁČENÉ V LATEXU
**CE EN
388**

Č.p.	specifikace	
50529	velikost 10"	12

UKAVICE ZAHRADNÍ

Č.p.	specifikace	
50557	velikost 7"	12
50558	velikost 8"	12
50549	velikost 9"	12

UKAVICE BAVLNĚNÉ

· S PVC terčíky



Č.p.	specifikace	
50531	velikost 9"	12

RUKAVICE MECHANIK - KOZÍ KŮŽE



RUKAVICE MECHANIK, NYLON - VEPŘOVICE



RUKAVICE -NYLON, MÁČENÉ V POLYURETANU



Č.p.	specifikace	
50541	velikost 9"	12
50542	velikost 10"	12

Č.p.	specifikace	
50544	velikost 10"	12

Č.p.	specifikace	
50527	velikost 10"	12

RUKAVICE SVÁŘEČSKÉ, KOŽENÉ



RUKAVICE LATEXOVÉ JEDNORÁZOVÉ



RUKAVICE VINYLÓVÉ JEDNORÁZOVÉ



Č.p.	specifikace	
50540	velikost 11"	12

Č.p.	specifikace	
50530		200

Č.p.	specifikace	
50532	čiré, nepudrované velikost 9"	100

OCHRANNÁ KOMBINÉZA S KAPUCÍ



ZÁSTĚRA NA SVAŘOVÁNÍ



Č.p.	specifikace	
50585	velikost M	1
50586	velikost L	1
50587	velikost XL	1
50588	velikost XXL	1

Č.p.	specifikace	
50555	kůže	1

KLEKÁTKO POJÍZDNÉ



Č.p. 37135 specifikace 1

OCHRANA KOLEN



Č.p. 37145 specifikace gel 8

OCHRANA KOLEN



OCHRANA KOLEN



OCHRANA KOLEN



Č.p. 37140 specifikace gel 12



Č.p. 37144 specifikace gel 12



Č.p. 37143 specifikace 12

OCHRANA KOLEN



OCHRANA KOLEN

OCHRANA KOLEN



Č.p. 37142 specifikace komfort 20



Č.p. 37139 specifikace neopren 10



Č.p. 37141 specifikace 6

TAŠKA NA NÁŘADÍ S KOVOVOU RUKOJETÍ

FESTA®

· kvalitní kovová rukojeť, polstrovaná

· popruhy se suchým zipem pro upevnění dlouhého nářadí

· pohodlný ramení, odnímatelný popruh

· vyztužená vnitřní konstrukce

Č.p.	výška	délka	hloubka
37331	280 mm	490 mm	230 mm



OPASEK SE SPONOU

FESTA®

Č.p.	specifikace
37328	145 cm



POUZDRO NÁŘAĐOVÉ

FESTA®

· vyztužené kapsy

Č.p.	specifikace
37325	



POUZDRO NÁŘAĐOVÉ

FESTA®

· vyztužené kapsy

Č.p.	specifikace
37326	



TAŠKA

FESTA®

NEW



Č.p.	šířka	výška	hloubka
37332	480 mm	290 mm	250 mm



1

TAŠKA

FESTA®



Č.p.	šířka	výška	hloubka
37330	610 mm	400 mm	270 mm



5

OPASEK MONTÁŽNÍ - SADA

FESTA®

· 14 kapes + oko



Č.p.	délka	šířka
37311	120 cm	6 cm



1

POUZDRO NÁŘADOVÉ

FESTA

· 8 kapsy



1

Č.p.	šířka	výška
37320	300 mm	250 mm

POUZDRO NÁŘADOVÉ

FESTA

· 4 kapsy



1

Č.p.	šířka	výška
37321	350 mm	300 mm

POUZDRO NA DROBNÉ NÁŘADÍ

FESTA



1

Č.p.	šířka	výška
37314	150 mm	250 mm

POUZDRO SE SPONOU

FESTA



1

Č.p.	šířka	výška
37312	10 mm	210 mm

POUZDRO UNIVERZÁLNÍ

FESTA



1

Č.p.	šířka	výška
37313	85 mm	160 mm

OPASEK NYLONOVÝ

FESTA



1

Č.p.	délka	šířka
37310	120 cm	6 cm

VESTA PRACOVNÍ

FESTA



20

Č.p.	specifikace
37350	

PÁS NÁŘADOVÝ KOŽENÝ

FESTA®



Č.p.	specifikace	
37302	6 kapes	50
37303	11 kapes	25

PÁS NÁŘADOVÝ KOŽENÝ



Č.p.	specifikace	
37300	6 kapes	50
37301	11 kapes	25



BRAŠNA KOŽENÁ PROFESIONÁLNÍ



Č.p.	výška	délka	hloubka	
37342	270 mm	430 mm	180 mm	1

BRAŠNA ELEKTRIKÁŘSKÁ KOŽENÁ



Č.p.	výška	délka	hloubka	
37341	260 mm	430 mm	200 mm	1

BRAŠNA KOŽENÁ S VYZTUŽENÝM DNEM



Č.p.	výška	délka	hloubka	
37340	240 mm	430 mm	150 mm	1

BRAŠNA ŘEMESLNICKÁ S POPRUHEM



Č.p.	výška	délka	hloubka	
37344	250 mm	300 mm	130 mm	1

BRAŠNA S VYZTUŽENÝM DNEM



Č.p.	výška	délka	hloubka	
37343	240 mm	430 mm	150 mm	1

BRAŠNA ELEKTRIKÁŘSKÁ



Č.p.	výška	délka	hloubka	
37345	270 mm	430 mm	180 mm	1

SPONA - KŮŽE "O"



Č.p.	specifikace	
37308		20

SPONA - KŮŽE "U"



Č.p.	specifikace	
37309		20

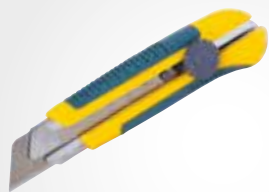

136

ODLAMOVCÍ NOŽE KDS



138

ODLAMOVCÍ NOŽE FESTA



144

ŠKRABKY



145

NÁHRADNÍ ČEPELE



147

NOŽE A MAČETY



152

SVÁŘEČKY, ŘEZAČE, KLEŠTĚ NA PVC TRUBKY



155

ŘEZAČKY NA POLYSTYREN

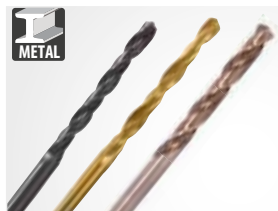

157

VRTÁKY DO KOVU



166

VYKRUŽOVÁKY, SEKÁČE, PRŮBOJNÍKY



170

DIAMANTOVÉ KORUNKY



174

VRTÁKY DO DŘEVA, VYKRUŽOVACÍ PILY, FRÉZY



178

SKLÍČIDLA

VRTÁKY, ŘEZNÉ
A BRUSNÉ NÁSTROJE

134 - 209



179

ROTAČNÍ BRUSNÉ KARTÁČE



183

BRUSNÉ KOTOUČE A PAPÍRY



188

RAŠPLE NA SÁDROKARTON



189

PILNÍKY A RAŠPLE



191

PILOVÉ KOTOUČE, PLÁTKY



194

PILOVÉ PLÁTKY



197

PILY NA DŘEVO, KOV A JINÉ



203

DIAMANTOVÉ KOTOUČE



206

ŘEZNÉ A BRUSNÉ KOTOUČE

KDS®

Nože japonské firmy KDS

- vynikající ergonomie rukojetí
- vysoký výkon a životnost břitů
- nejlepší použité materiály břitů
- nízký řezný odpor umožňující lehký řez

NŮŽ ODLAMOVACÍ



KDS®



č.p.	specifikace	
16002	LC405 18 mm zelený	25
16104	LC405 18 mm červený	25

č.p.	specifikace	
16011	LB10 náhradní čepele	10

NŮŽ ODLAMOVACÍ



KDS®

NŮŽ ODLAMOVACÍ



KDS®



č.p.	specifikace	
16003	G11 18 mm + 2 čepele	10
16012	GB10 náhradní čepele	10

č.p.	specifikace	
16019	L19 18 mm + 2 čepele	10
16011	LB10 náhradní čepele	10
16012	GB10 náhradní čepele	10

NŮŽ ODLAMOVACÍ

KDS®



Č.p.	specifikace	
16004	H11 25 mm	10
16013	HB10 náhradní čepele	10

NŮŽ ODLAMOVACÍ

KDS®



Č.p.	specifikace	
16005	S14 9 mm + 2 čepele	10
16010	SB10 náhradní čepele	10

SKALPEL

KDS®



Č.p.	specifikace	
16006	D11 + 16 čepelí	10
16014	DB 48 náhradní čepele	10

ČEPEL NÁHRADNÍ KDS

KDS®

10x



Č.p.	specifikace	
16010	SB10 9 0,38 mm 13 segmentů	20
16011	LB10 18 0,5 mm 15 segmentů	20
16012	GB10 18 0,6 mm 15 segmentů	20
16013	HB10 25 0,7 mm 7 segmentů	10

ČEPEL NÁHRADNÍ KDS

KDS®

10x



- speciální slitina
- dvojitý broušení
- zvýšená životnost
- nízký řezný odpor
- umožňující lehké řezání

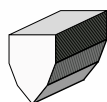

Č.p.	specifikace	
16016	LB10B 18 0,5 mm 8 segmentů	20
16017	HB10B 25 0,7 mm 7 segmentů	10

STOJAN NA ODLAMOVACÍ NOŽE

KDS®

osazení stojanu 16998

- 16001 · 5 ks
- 16003 · 5 ks
- 16004 · 3 ks
- 16005 · 3 ks
- 16006 · 2 ks
- 16008 · 3 ks
- 16010 · 4 ks
- 16012 · 4 ks
- 16013 · 1 ks
- 16016 · 4 ks
- 16018 · 4 ks
- 16019 · 4 ks
- 16020 · 4 ks



• ilustrační foto

Č.p.	specifikace	
16999	reklamní stojan	1
16998	osazený reklamní stojan	1

FESTO
NŮŽ ODLAMOVCÍ

FESTO
NŮŽ ODLAMOVCÍ S KERAMICKOU ČEPELÍ
FESTO

- 3x ostřejší než čepel ocelová
- 10x delší životnost
- žáruvzdorná, nevodivá, nemagnetická



Č.p.	specifikace	
16131	18 mm	10
16066	náhradní čepel 18 mm, 5 ks	10

NŮŽ ODLAMOVCÍ

FESTO
NŮŽ ODLAMOVCÍ
FESTO

Č.p.	specifikace	
16110	L11 18 mm + 1 čepel	12



Č.p.	specifikace	
16100	L12 18 mm + 1 čepel	12

NŮŽ ODLAMOVCÍ

FESTO
NŮŽ ODLAMOVCÍ
FESTO

Č.p.	specifikace	
16105	L17 18 mm + 1 čepel	12

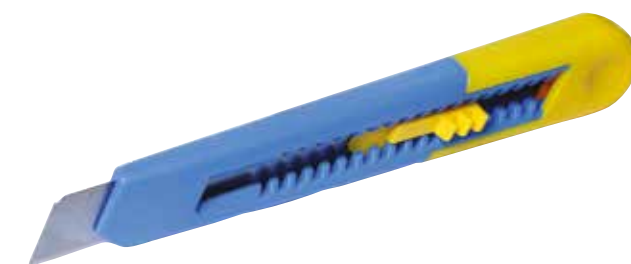

Č.p.	specifikace	
16125	L4 9 mm	24
16120	L8 18 mm	24

NŮŽ ODLAMOVCÍ

FESTO
NŮŽ ODLAMOVCÍ
FESTO

Č.p.	specifikace	
16115	L10 9 mm	24

ALU

Č.p.	specifikace	
16150	18 mm	MOQ 24
16151	18 mm bez loga FESTO	20

NŮŽ ODLAMOVACÍ **FESTA**

NEW

ALU



Č.p. specifikace
16136 18 mm

1

NŮŽ ODLAMOVACÍ **FESTA**

NEW

ALU



Č.p. specifikace
16137 25 mm

1

NŮŽ ODLAMOVACÍ **FESTA**

+4

ALU



· protiskluzové pogumování

Č.p. specifikace
16090 18 mm

12

NŮŽ ODLAMOVACÍ **FESTA**

+4

ALU



· protiskluzové pogumování

Č.p. specifikace
16091 25 mm

6

NŮŽ ODLAMOVACÍ **FESTA**

ALU



· protiskluzové pogumování

Č.p. specifikace
16145 L25 18 mm

12

NŮŽ ODLAMOVACÍ **FESTA**

ALU



· protiskluzové pogumování

Č.p. specifikace
16144 L24 18 mm

12

NŮŽ ODLAMOVACÍ

NEW

ALU



Č.p. specifikace
16143 18 mm

1

NŮŽ ODLAMOVACÍ

NEW

ALU



Č.p. specifikace
16142 18 mm

1

NŮŽ ODLAMOVCÍ

NEW

ALU



1

Č.p. 16025
specifikace 18 mm

NŮŽ ODLAMOVCÍ

ALU

FESTA



25

Č.p. 16029
specifikace 18 mm

NŮŽ ODLAMOVCÍ

FESTA



12

· protiskluzové pogumování

Č.p. 16146
specifikace 18 mm

NŮŽ ODLAMOVCÍ

FESTA



12

· protiskluzové pogumování

Č.p. 16147
specifikace 25 mm

NŮŽ ODLAMOVCÍ

FESTA

+5



12

· protiskluzové pogumování

Č.p. 16130
specifikace L18 18 mm

NŮŽ ODLAMOVCÍ

FESTA

+5



6

· protiskluzové pogumování

Č.p. 16135
specifikace L20 25 mm + 5 čepelek | blades

NŮŽ ODLAMOVCÍ

FESTA



12

· protiskluzové pogumování

Č.p. 16140
specifikace L22 18 mm

NŮŽ ODLAMOVCÍ

FESTA

ALU



12

· protiskluzové pogumování

Č.p. 16034
specifikace 25 mm

NŮŽ ODLAMOVCÍ

FESTA

INOX



24

Č.p. specifikace
16085 9 mm

NŮŽ ODLAMOVCÍ

FESTA

INOX



24

Č.p. specifikace
16086 18 mm

NŮŽ BEZPEČNOSTNÍ



· samozatahovací čepel

Č.p. specifikace
16057 135 mm

1

NŮŽ BEZPEČNOSTNÍ

FESTA

ALU

INOX



16074



1

Č.p. specifikace
16058 1

16074 náhradní čepel 10 ks 1

NŮŽ TURBO

FESTA

+5
ALU



6

Č.p. specifikace
16037

NŮŽ ZAVÍRACÍ

FESTA

+5
ALU



12

Č.p. specifikace
16023 Nůž zavírací

16071 Náhradní čepel 10 ks 10

NŮŽ ZAVÍRACÍ, SADA ČEPELÍ

FESTA

ALU



Č.p. specifikace
16095 25 čepelek

1

NŮŽ S ARETACÍ

FESTA

NŮŽ S ARETACÍ

FESTA

ALU

+2

ALU

+3



· protiskluzové pogumování



Č.p. specifikace

Č.p. specifikace

Č.p. specifikace

16035

12

16033

NP 110

5

NŮŽ S ARETACÍ

FESTA

NŮŽ S ARETACÍ

ALU

+5

ALU



Č.p. specifikace

Č.p. specifikace

Č.p. specifikace

16038

12

16032

NP 109

48

NŮŽ S ARETACÍ

ALU

NŮŽ

ALU



Č.p. specifikace

Č.p. specifikace

Č.p. specifikace

16031 NS 107 B

24

16030

NS 107

24

NŮŽ NA PODLAHOVINY

NŮŽ HÁKOVÝ



· na koberce a podlahové krytiny



· na koberce a podlahové krytiny



Č.p. specifikace

Č.p. specifikace

Č.p. specifikace

16036 45 mm

12

16041

12

NŮŽ ODLAMOVCÍ

ALU



Č.p.	specifikace	
16046	18 mm	12

NŮŽ ODLAMOVCÍ



Č.p.	specifikace	
16028	S 201 18 mm	24

NŮŽ ODLAMOVCÍ



Č.p.	specifikace	
16026	P 205 18 mm	30

NŮŽ ODLAMOVCÍ

HOBBY



Č.p.	specifikace	
16021	P 201 9 mm	60

NŮŽ ODLAMOVCÍ

HOBBY



Č.p.	specifikace	
16024	P 204 18 mm	60

NŮŽ ODLAMOVCÍ



protiskuzové pogumování

Č.p.	specifikace	
16141	18 mm	24

MOQ
24



SADA NOŽŮ

HOBBY

12x



Č.p.	specifikace	
16053	9 mm	12
16055	18 mm	12

SADA NOŽŮ

HOBBY

3x



Č.p.	specifikace	
16043		24



ŠKRABKA

NEW

ALU



Č.p.	specifikace	
16059	50 mm	1
16082	břit náhradní	1

ŠKRABKA

NEW

ALU



Č.p.	specifikace	
16054	100 mm	1

· pro použití s 18 mm čepeli k odlamovacím nožům

ŠKRABKA POGUMOVANÁ

FESTA



Č.p.	specifikace	
16049		12
16069	náhradní čepel	1

· protiskluzové pogumování

ŠKRABKA

FESTA



Č.p.	specifikace	
16052	48 cm délka	6
16070	čepel	25

ŠKRABKA



Č.p.	specifikace	
16051		24

ŠKRABKA



Č.p.	specifikace	
16050		24

SADA NA APLIKACI A ODSTRANĚNÍ SILIKONU

3x



Č.p.	specifikace	
16042		12

ČEPEL NÁHRADNÍ **FESTA**

SK2

10x



- 7 segmentů
- 3x delší životnost
- dvojitý broušení
- nízký řezný odpor

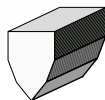

Č.p. specifikace
16064 25 | 0,7 mm

20

ČEPEL NÁHRADNÍ

10x



- 7 segmentů



Č.p. specifikace
16068 25 | 0,6 mm

20

ČEPEL NÁHRADNÍ **FESTA**

SK2

10x



- 8 segmentů
- 3x delší životnost
- dvojitý broušení
- nízký řezný odpor

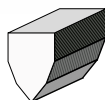

Č.p. specifikace
16062 18 | 0,7 mm

10

ČEPEL NÁHRADNÍ **FESTA**

SK2

10x



- 15 segmentů
- 3x delší životnost
- dvojitý broušení
- nízký řezný odpor

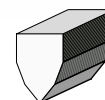

Č.p. specifikace
16063 18 | 0,7 mm

10

ČEPEL NÁHRADNÍ KERAMICKÁ **FESTA**

5x

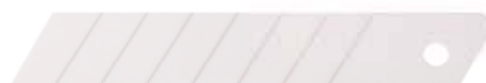

- 8 segmentů
- 3x ostřejší než čepel ocelová
- 10x delší životnost
- Záruvzdorná, nevodivá, nemagnetická



Č.p. specifikace
16066 18 | 0,6 mm

10

ČEPEL NÁHRADNÍ

10x



- 4 segmenty



Č.p. specifikace
16067 18 | 0,5 mm

10

ČEPEL NÁHRADNÍ

10x



- 8 segmentů



Č.p. specifikace
16065 18 | 0,5 mm

60

ČEPEL NÁHRADNÍ

10x



- 15 segmentů



Č.p. specifikace
16081 18 | 0,5 mm

60

ČEPEL NÁHRADNÍ

10x



- dvojitý broušení

- 8 segmentů



Č.p. specifikace
16078 18 | 0,5 mm

25



ČEPEL NÁHRADNÍ

10x



- dvojitý broušení

- 8 segmentů



Č.p. specifikace
16077 18 | 0,6 mm

25



ČEPEL NÁHRADNÍ 30°

10x



ČEPEL NÁHRADNÍ

10x



· 7 segmentů



· 13 segmentů

Č.p. specifikace
16061 9 | 0,4 mm

60

Č.p. specifikace
16060 9 | 0,45 mm

10

ČEPEL NÁHRADNÍ



10x



ČEPEL NÁHRADNÍ



10x



ČEPEL NÁHRADNÍ



10x



· pro 16058

Č.p. specifikace
16074

1

Č.p. specifikace
16072 R 004

10

Č.p. specifikace
16075 R 003

10

ČEPEL NÁHRADNÍ

10x



Č.p. specifikace
16071 R 001

60

ČEPEL NÁHRADNÍ

10x



Č.p. specifikace
16073 R 002

60

ČEPEL NÁHRADNÍ

5x



Č.p. specifikace
16084 18 mm

50

ČEPEL NÁHRADNÍ

5x



Č.p. specifikace
16083 18 mm

50

ČEPEL NÁHRADNÍ

· pro 34315

Č.p. specifikace
34316

1



ČEPEL NÁHRADNÍ NA ŠKRABKU

· pro 16052

Č.p. specifikace
16070 100 mm

25



NŮŽ LOVECKÝ

FESTA

INOX

TEFLON

NYLON



- nylonová rukojeť
- čepel s teflonovým povrchem
- pouzdro s pojistkou a klipem



Č.p.	specifikace
16234	21 10 cm

Č.p.	specifikace
10	

NŮŽ LOVECKÝ

FESTA

INOX

TEFLON



Č.p.	specifikace
16229	23 10 cm

Č.p.	specifikace
12	

DLÁTO TRUHLÁŘSKÉ MULTIFUNKČNÍ

FESTA

INOX



- zesílená čepel

Č.p.	specifikace
16231	20 8 cm



Č.p.	specifikace
12	

NŮŽ TECHNICKÝ

INOX



- zesílená čepel

Č.p.	specifikace
16230	21 10 cm

Č.p.	specifikace
12	

NŮŽ

INOX



Č.p.	specifikace
16022	16 6,5 cm

Č.p.	specifikace
100	

NŮŽ ZAHNUTÝ NA PODLAHOVINY

FESTA

Č.p.	specifikace
16225	20 8,5 cm

Č.p.	specifikace
12	

NŮŽ ELEKTRIKÁŘSKÝ

FESTA

INOX



- zesílená čepel

Č.p.	specifikace
16212	15 3,2 cm

Č.p.	specifikace
12	

NŮŽ ODIZOLOVÁVACÍ

FESTA

Č.p.	specifikace
16201	Ø 8 - 27 mm

Č.p.	specifikace
10	

NŮŽ ELEKTRIKÁŘSKÝ

INOX

FESTA



10

Č.p.	specifikace
16211	20 8,5 cm

NŮŽ ELEKTRIKÁŘSKÝ

INOX

FESTA



10

Č.p.	specifikace
16210	20,5 9 cm

NŮŽ OČKOVACÍ

INOX

FESTA



24

Č.p.	specifikace
16219	19 11 cm

NŮŽ ROUBOVACÍ

INOX

FESTA



24

Č.p.	specifikace
16218	18,5 10,5 cm

NŮŽ ŠTĚPAŘSKÝ

INOX

FESTA



24

Č.p.	specifikace
16220	18,5 11 cm

NŮŽ ZAVÍRACÍ

INOX

FESTA



24

Č.p.	specifikace
16235	17,5 8,5 cm

NŮŽ ZAVÍRACÍ

INOX

FESTA



24

Č.p.	specifikace
16221	21 12 cm

NŮŽ ZAVÍRACÍ

INOX

FESTA



24

Č.p.	specifikace
16236	22,5 11 cm

NŮŽ ZAVÍRACÍ

FESTA



1

Č.p.

specifikace

16209

14,5 | 5,5 cm

NŮŽ ZAVÍRACÍ

FESTA

INOX



24

Č.p.

specifikace

16222

20 | 12 cm

NŮŽ ZAVÍRACÍ

FESTA

INOX

ALU



24

Č.p.

specifikace

16223

18,5 | 10,5 cm

NŮŽ ZAVÍRACÍ MULTIFUNKČNÍ

FESTA

INOX



24

· 10 funkcí

Č.p.

specifikace

16226

17,5 | 7 cm

NŮŽ ZAVÍRACÍ MULTIFUNKČNÍ

FESTA

INOX



24

· 5 funkcí

Č.p.

specifikace

16228

27 | 10,5 cm

NŮŽ ZAVÍRACÍ LOVECKÝ

· 3 funkcí

Č.p.

specifikace

16227

20,5 | 10 cm



24

NŮŽ ZAVÍRACÍ MULTIFUNKČNÍ

INOX

· 7 funkcí

Č.p.

specifikace

16224

17,5 | 7 cm



24

KLEŠTĚ MULTIFUNKČNÍ

FESTA®

CrV



- 9 funkcí
- pouzdro

Č.p. specifikace

16232



12

NŮŽ NA MINERÁLNÍ VATU

FESTA®

NŮŽ NA IZOLACE

FESTA®



Č.p. specifikace

16198 44,5 | 33 cm

12



- na minerální vatu, polystyren

Č.p. specifikace

16199 48 | 35 cm

10

MAČETA

FESTA®

MAČETA

FESTA®

TEFLON

TEFLON



Č.p. specifikace

45069 440 mm

6

Č.p. specifikace

44950 490 mm

4

MAČETA NEREZ

INOX

MAČETA



- rukojeť vyrobená z jasanového dřeva

Č.p. specifikace

45083 430 mm
45084 600 mm

12
6

Č.p. specifikace

45081 510 mm
45082 710 mm

36
36

SADA SKALPELŮ

23x



24

Č.p. specifikace

16282

SADA SKALPELŮ

13x



10

Č.p. specifikace

16281

BROUSEK OVÁLNÝ



Č.p. specifikace

45370 250 x 33 x 18 mm



20

BROUSEK



Č.p. specifikace

45045 150 x 50 x 30 mm



1

BROUSEK NA KOSU



Č.p. specifikace

45046 205 x 15 mm



100

BROUSEK NA NOŽE A NŮŽKY



Č.p. specifikace

16991



20

BROUSEK NA NOŽE A NŮŽKY



Č.p. specifikace

16990 Ø 50 mm



1

BROUSEK NA NOŽE A NŮŽKY



Č.p. specifikace

45048



20

BROUSEK NA NOŽE A NŮŽKY 6 V 1



Č.p. specifikace

45068



10

POLYFÚZNÍ SVÁŘEČKA PLASTOVÝCH TRUBEK

FESTA®



TEFLON

- napětí / frekvence
- příkon
- teplota
- nástavce
- váha

230 V / 50 Hz
750 / 1500 W
0-300 C°
Ø 20,25,32,40,50,63 mm
1,6 kg



- součást balení: metr, vodováha, šroubovák, inbus klíč, nůžky na trubky, 6x svařovací nástavec, stojánek, plechový kufr

č.p.

17182



1

HROTOVÁ POLYFÚZNÍ SVÁŘEČKA PLASTOVÝCH TRUBEK

FESTA®



TEFLON

- napětí / frekvence
- příkon
- teplota
- nástavce
- váha

230 V / 50 Hz
800 / 1000 W
0-300 C°
Ø 16, 20, 25, 32 mm
1 kg



- součást balení: inbus, 4x svařovací nástavec, stojánek, plechový kufr

č.p.

17183



1



FESTA®

KLEŠTĚ NA PVC TRUBKY

FESTA®

Ø max.
42 mm



Č.p. specifikace

17027		10
16315	náhradní čepel	1



10
1

ČEPEL NÁHRADNÍ PRO KLEŠTĚ



· pro klešče 17027

Č.p. specifikace

16315		1
-------	--	---



KLEŠTĚ NA PVC TRUBKY

Ø max.
42 mm



Č.p. specifikace

17026		6
-------	--	---



6

NŮŽKY NA PVC LIŠTY A TRUBKY

FESTA®

Ø 16 mm

Ø 19 mm

Ø 25 mm

5x



· lišty, trubky, profily

Č.p. specifikace

17050		8
-------	--	---



8

ŘEZAČ TENKOSTĚNNÝCH TRUBEK

ID 3-22
mm

FESTA



Č.p.	specifikace	
16301		10
16311	náhradní kolečko	1

ŘEZAČ TENKOSTĚNNÝCH TRUBEK

ID 6-64
mm

Č.p.	specifikace	
16304		6
16312	náhradní kolečko	1

ŘEZAČ TENKOSTĚNNÝCH TRUBEK

ID 3-32
mm

Č.p.	specifikace	
16303		10
16311	náhradní kolečko	1

ŘEZAČ TENKOSTĚNNÝCH TRUBEK

ID 3-32
mm

Č.p.	specifikace	
16300		10
16310	náhradní kolečko	1

KOLEČKO NÁHRADNÍ PRO ŘEZAČE PVC TRUBEK

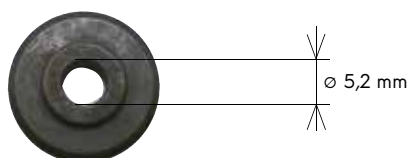

Č.p.	specifikace	
16310	Ø 17,5 mm x 6 m pro 16300	1
16311	Ø 18,0 mm x 4,5 mm pro 16303, 16301	1
16312	Ø 27,5 mm x 6 mm pro 16304	1

ODJEHLOVAČ NA TRUBKY

ID 6-32
mm

Č.p.	specifikace	
16320		1

FRÉZA ODJEHLOVACÍ, RUČNÍ HSS

1/4"

HSS

4x



Č.p.	specifikace	
20360		10

ODJEHLOVAČ



Č.p.	specifikace	
20361		1

ŘEZAČKA POLYSTYRENU STRUNOVÁ

FESTA®

- napětí/frekvence: 230 V / 50 Hz
- příkon: 160 W
- délka řezu: 137 cm
- výška řezu: 30 cm
- krytí: IP44
- úhel řezu: 0° - 90°

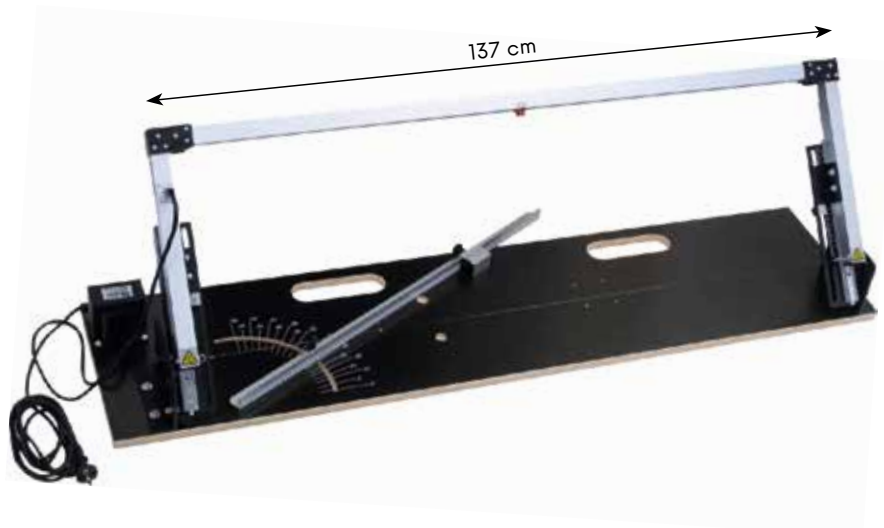
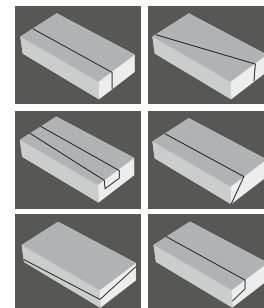

- vybavení: Ni-Cr řezací drát, čistící mosazný kartáč, inbus



Č.p.	specifikace	
35345	Řezačka polystyrenu 1500 x 450 mm	1
35346	Náhradní řezná struna Ni-Cr	1
35347	Náhradní zdroj	1

ŘEZAČKA POLYSTYRENU STRUNOVÁ

FESTA®

- napětí/frekvence: 230 V / 50 Hz
- příkon: 160 W
- délka řezu: 120 cm
- výška řezu: 30 cm
- krytí: IP44
- úhel řezu: 0° - 90°

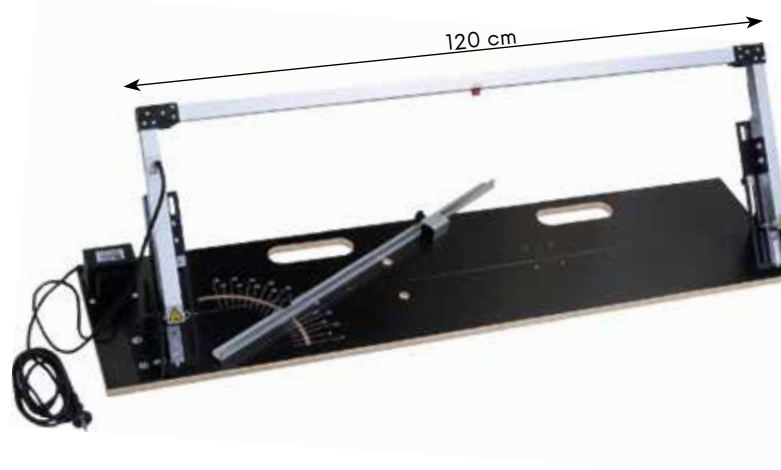
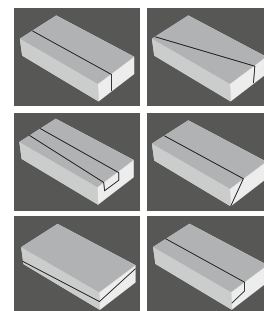

- vybavení: Ni-Cr řezací drát, čistící mosazný kartáč, inbus



Č.p.	specifikace	
35330	Řezačka polystyrenu 1350 x 450 mm	1
35331	Náhradní řezná struna Ni-Cr	1
35347	Náhradní zdroj	1

ŘEZAČKA POLYSTYRENU AKUMULÁTOROVÁ

FESTA®



- baterie
- výkon
- teplota
- délka čepele

36 V, 1,5Ah Li-ion
180 W
max 350 C°
20 cm



- vybavení: 2 ks baterie, nabíječka, čepele, čisticí mosazný kartáč, inbus

Č.p. specifikace

35323



1

ŘEZAČKA POLYSTYRENU ELEKTRICKÁ

FESTA®

VODÍCÍ LIŠTA PRO ŘEZAČKU POLYSTYRENU



- napětí / frekvence
- příkon
- teplota
- délka čepele
- délka přívodního kabelu

230 V/50 Hz
250 W
50-600 C°
25 cm
3 m



- pro 35323, 35326



- vybavení: čisticí mosazný kartáč, inbus, nůž 25 cm, kufr

Č.p. specifikace



35326	Elektrická řezačka polystyrenu	1
35328	Náhr. nůž do řezačky polystyrenu 14 cm	1
35329	Náhr. nůž do řezačky polystyrenu 25 cm	1

Č.p. specifikace



35327	Vodící lišta	1
35335	Náhradní nůž - 30 cm	1

ŘEZAČKA POLYSTYRENU ELEKTRICKÁ



- regulace teploty

Č.p. specifikace

35325 220 W



1

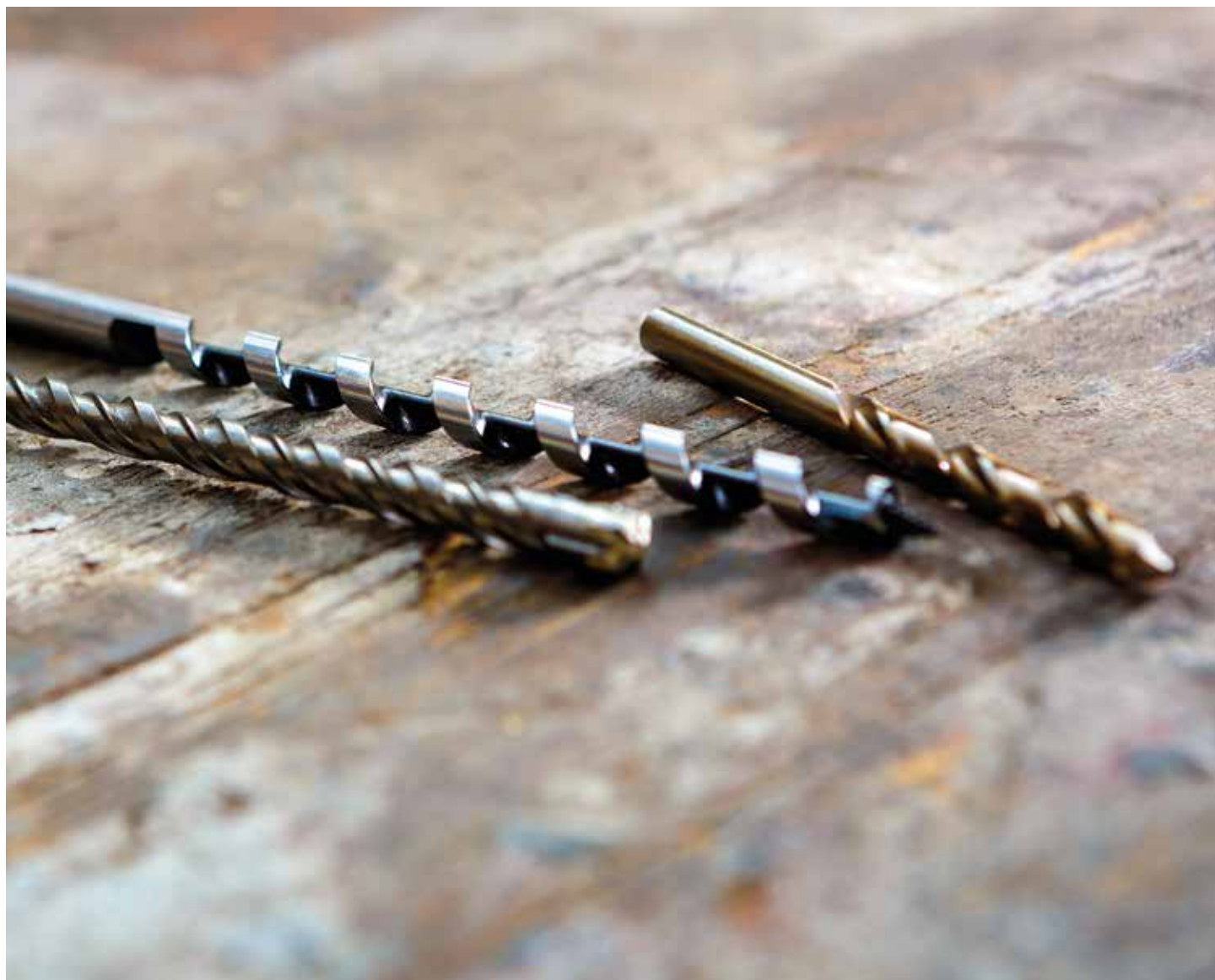

VRTÁK VYBRUŠOVANÝ DO KOVU HSS-G COBALT 5 %

Co 5%, W 6%
Mo 5%, Cr 4%, V 4%

HSS

DIN
338

135°



INOX 1400 MPa

Č.p.	specifikace		Č.p.	specifikace		Č.p.	specifikace	
22510	Ø 1,00 mm	1	22548	Ø 4,80 mm	1	22590	Ø 9,00 mm	1
22515	Ø 1,50 mm	1	22550	Ø 5,00 mm	1	22595	Ø 9,50 mm	1
22520	Ø 2,00 mm	1	22555	Ø 5,50 mm	1	22600	Ø 10,00 mm	1
22525	Ø 2,50 mm	1	22560	Ø 6,00 mm	1	22602	Ø 10,20 mm	1
22530	Ø 3,00 mm	1	22565	Ø 6,50 mm	1	22605	Ø 10,50 mm	1
22532	Ø 3,20 mm	1	22568	Ø 6,80 mm	1	22610	Ø 11,00 mm	1
22535	Ø 3,50 mm	1	22570	Ø 7,00 mm	1	22615	Ø 11,50 mm	1
22540	Ø 4,00 mm	1	22575	Ø 7,50 mm	1	22620	Ø 12,00 mm	1
22542	Ø 4,20 mm	1	22580	Ø 8,00 mm	1	22625	Ø 12,50 mm	1
22545	Ø 4,50 mm	1	22585	Ø 8,50 mm	1	22630	Ø 13,00 mm	1

VRTÁK VYBRUŠOVANÝ DO KOVU HSS-G W 9 %

FESTA

W 9%, Mo 3%
Cr 4%, V 1%

HSS

DIN
338

MOQ

INOX 1100
MPa

Č.p.	specifikace		Č.p.	specifikace	
19530	Ø 1,00 mm	10	19556	Ø 3,60 mm	10
19531	Ø 1,10 mm	10	19557	Ø 3,70 mm	10
19532	Ø 1,20 mm	10	19558	Ø 3,80 mm	10
19533	Ø 1,30 mm	10	19559	Ø 3,90 mm	10
19534	Ø 1,40 mm	10	19560	Ø 4,00 mm	10
19535	Ø 1,50 mm	10	19561	Ø 4,10 mm	10
19536	Ø 1,60 mm	10	19562	Ø 4,20 mm	10
19537	Ø 1,70 mm	10	19563	Ø 4,30 mm	10
19538	Ø 1,80 mm	10	19564	Ø 4,40 mm	10
19539	Ø 1,90 mm	10	19565	Ø 4,50 mm	10
19540	Ø 2,00 mm	10	19566	Ø 4,60 mm	10
19541	Ø 2,10 mm	10	19567	Ø 4,70 mm	10
19542	Ø 2,20 mm	10	19568	Ø 4,80 mm	10
19543	Ø 2,30 mm	10	19569	Ø 4,90 mm	5
19544	Ø 2,40 mm	10	19570	Ø 5,00 mm	5
19545	Ø 2,50 mm	10	19571	Ø 5,10 mm	5
19546	Ø 2,60 mm	10	19572	Ø 5,20 mm	5
19547	Ø 2,70 mm	10	19573	Ø 5,30 mm	5
19548	Ø 2,80 mm	10	19574	Ø 5,40 mm	5
19549	Ø 2,90 mm	10	19575	Ø 5,50 mm	5
19550	Ø 3,00 mm	10	19576	Ø 5,60 mm	5
19551	Ø 3,10 mm	10	19577	Ø 5,70 mm	5
19552	Ø 3,20 mm	10	19578	Ø 5,80 mm	5
19553	Ø 3,30 mm	10	19579	Ø 5,90 mm	5
19554	Ø 3,40 mm	10	19580	Ø 6,00 mm	5
19555	Ø 3,50 mm	10	19581	Ø 6,10 mm	5

Č.p.	specifikace		Č.p.	specifikace	
19582	Ø 6,20 mm	5	19624	Ø 10,40 mm	3
19583	Ø 6,30 mm	5	19625	Ø 10,50 mm	3
19584	Ø 6,40 mm	5	19626	Ø 10,60 mm	3
19585	Ø 6,50 mm	5	19627	Ø 10,70 mm	3
19586	Ø 6,60 mm	5	19628	Ø 10,80 mm	3
19587	Ø 6,70 mm	5	19629	Ø 10,90 mm	3
19588	Ø 6,80 mm	5	19630	Ø 11,00 mm	3
19589	Ø 6,90 mm	5	19631	Ø 11,10 mm	3
19590	Ø 7,00 mm	5	19632	Ø 11,20 mm	3
19591	Ø 7,10 mm	5	19633	Ø 11,30 mm	3
19592	Ø 7,20 mm	5	19634	Ø 11,40 mm	3
19593	Ø 7,30 mm	5	19635	Ø 11,50 mm	3
19594	Ø 7,40 mm	5	19636	Ø 11,60 mm	3
19595	Ø 7,50 mm	5	19637	Ø 11,70 mm	3
19596	Ø 7,60 mm	5	19638	Ø 11,80 mm	3
19597	Ø 7,70 mm	5	19639	Ø 11,90 mm	3
19598	Ø 7,80 mm	5	19640	Ø 12,00 mm	3
19599	Ø 7,90 mm	5	19641	Ø 12,10 mm	3
19600	Ø 8,00 mm	5	19642	Ø 12,20 mm	3
19601	Ø 8,10 mm	5	19643	Ø 12,30 mm	3
19602	Ø 8,20 mm	5	19644	Ø 12,40 mm	3
19603	Ø 8,30 mm	5	19645	Ø 12,50 mm	3
19604	Ø 8,40 mm	5	19646	Ø 12,60 mm	1
19605	Ø 8,50 mm	5	19647	Ø 12,70 mm	1
19606	Ø 8,60 mm	5	19648	Ø 12,80 mm	1
19607	Ø 8,70 mm	5	19649	Ø 12,90 mm	1
19608	Ø 8,80 mm	5	19650	Ø 13,00 mm	1
19609	Ø 8,90 mm	5	19651	Ø 13,20 mm R13	1
19610	Ø 9,00 mm	5	19652	Ø 13,50 mm R13	1
19611	Ø 9,10 mm	5	19653	Ø 14,00 mm R13	1
19612	Ø 9,20 mm	5	19654	Ø 14,50 mm R13	1
19613	Ø 9,30 mm	5	19655	Ø 15,00 mm R13	1
19614	Ø 9,40 mm	5	19656	Ø 15,50 mm R13	1
19615	Ø 9,50 mm	3	19657	Ø 16,00 mm R13	1
19616	Ø 9,60 mm	3	19658	Ø 16,50 mm R13	1
19617	Ø 9,70 mm	3	19659	Ø 17,00 mm R13	1
19618	Ø 9,80 mm	3	19660	Ø 17,50 mm R13	1
19619	Ø 9,90 mm	3	19661	Ø 18,00 mm R13	1
19620	Ø 10,00 mm	3	19662	Ø 18,50 mm R13	1
19621	Ø 10,10 mm	3	19663	Ø 19,00 mm R13	1
19622	Ø 10,20 mm	3	19664	Ø 19,50 mm R13	1
19623	Ø 10,30 mm	3	19665	Ø 20,00 mm R13	1

BOX S VYBRUŠOVANÝMI VRTÁKY DO KOVU HSS-G W 9 %

FESTA

W 9%, Mo 3%
Cr 4%, V 1%

HSS

DIN
338INOX 1100
MPa

Č.p. specifikace

19669



1

Č.p.	obsah sady	Č.p.	obsah sady
19530	Ø 1,00 mm 20x	19585	Ø 6,50 mm 15x
19535	Ø 1,50 mm 20x	19590	Ø 7,00 mm 15x
19540	Ø 2,00 mm 20x	19595	Ø 7,50 mm 15x
19545	Ø 2,50 mm 20x	19600	Ø 8,00 mm 15x
19550	Ø 3,00 mm 20x	19605	Ø 8,50 mm 15x
19552	Ø 3,20 mm 20x	19610	Ø 9,00 mm 15x
19555	Ø 3,50 mm 20x	19615	Ø 9,50 mm 15x
19558	Ø 3,80 mm 20x	19620	Ø 10,00 mm 15x
19560	Ø 4,00 mm 30x	19625	Ø 10,50 mm 6x
19562	Ø 4,20 mm 20x	19630	Ø 11,00 mm 6x
19565	Ø 4,50 mm 20x	19635	Ø 11,50 mm 6x
19568	Ø 4,80 mm 20x	19640	Ø 12,00 mm 6x
19570	Ø 5,00 mm 15x	19645	Ø 12,50 mm 6x
19575	Ø 5,50 mm 15x	19650	Ø 13,00 mm 6x
19580	Ø 6,00 mm 30x		

VRTÁK VYBRUŠOVANÝ DO KOVU

FESTA

 W 4%, Mo 3%
 Cr 4%, V 1%

HSS
**DIN
338**

MOQ

Č.p.	specifikace		Č.p.	specifikace		Č.p.	specifikace	
19670	Ø 0,6 mm	10	19694	Ø 3,1 mm	10	19760	Ø 9,7 mm	5
19671	Ø 0,8 mm	10	19695	Ø 3,2 mm	10	19761	Ø 9,8 mm	5
19672	Ø 0,9 mm	10	19696	Ø 3,3 mm	10	19762	Ø 9,9 mm	5
19673	Ø 1,0 mm	10	19697	Ø 3,4 mm	10	19763	Ø 10,0 mm	5
19674	Ø 1,1 mm	10	19698	Ø 3,5 mm	10	19764	Ø 10,1 mm	5
19675	Ø 1,2 mm	10	19699	Ø 3,6 mm	10	19765	Ø 10,2 mm	5
19676	Ø 1,3 mm	10	19700	Ø 3,7 mm	10	19766	Ø 10,3 mm	5
19677	Ø 1,4 mm	10	19701	Ø 3,8 mm	10	19767	Ø 10,4 mm	5
19678	Ø 1,5 mm	10	19702	Ø 3,9 mm	10	19768	Ø 10,5 mm	5
19679	Ø 1,6 mm	10	19703	Ø 4,0 mm	10	19769	Ø 10,6 mm	5
19680	Ø 1,7 mm	10	19704	Ø 4,1 mm	10	19770	Ø 10,7 mm	5
19681	Ø 1,8 mm	10	19705	Ø 4,2 mm	10	19771	Ø 10,8 mm	5
19682	Ø 1,9 mm	10	19706	Ø 4,3 mm	10	19772	Ø 11,0 mm	5
19683	Ø 2,0 mm	10	19707	Ø 4,4 mm	10	19773	Ø 11,2 mm	5
19684	Ø 2,1 mm	10	19708	Ø 4,5 mm	10	19774	Ø 11,3 mm	5
19685	Ø 2,2 mm	10	19709	Ø 4,6 mm	10	19775	Ø 11,4 mm	5
19686	Ø 2,3 mm	10	19710	Ø 4,7 mm	10	19776	Ø 11,5 mm	5
19687	Ø 2,4 mm	10	19711	Ø 4,8 mm	10	19777	Ø 11,6 mm	5
19688	Ø 2,5 mm	10	19712	Ø 4,9 mm	10	19778	Ø 11,7 mm	5
19689	Ø 2,6 mm	10	19713	Ø 5,0 mm	10	19779	Ø 11,8 mm	5
19690	Ø 2,7 mm	10	19714	Ø 5,1 mm	10	19780	Ø 11,9 mm	5
19691	Ø 2,8 mm	10	19715	Ø 5,2 mm	10	19781	Ø 12,0 mm	5
19692	Ø 2,9 mm	10	19716	Ø 5,3 mm	10	19782	Ø 12,2 mm	5
19693	Ø 3,0 mm	10	19717	Ø 5,4 mm	10	19783	Ø 12,5 mm	5
						19784	Ø 12,8 mm	5
						19785	Ø 12,9 mm	5
						19786	Ø 13,0 mm	5
						19787	Ø 13,2 mm R13	5
						19788	Ø 13,5 mm R13	5
						19789	Ø 14,0 mm R13	5
						19790	Ø 14,5 mm R13	5
						19791	Ø 15,0 mm R13	5
						19792	Ø 15,5 mm R13	5
						19793	Ø 16,0 mm R13	5
						19794	Ø 16,5 mm R13	5
						19795	Ø 17,0 mm R13	5
						19796	Ø 17,5 mm R13	5
						19797	Ø 18,0 mm R13	5
						19798	Ø 18,5 mm R13	5
						19799	Ø 19,0 mm R13	5
						19800	Ø 19,5 mm R13	5
						19801	Ø 20,0 mm R13	5

BOX S VYBRUŠOVANÝMI VRTÁKY DO KOVU HSS 4341

FESTA

 W 4%, Mo 3%
 Cr 4%, V 1%

HSS
**DIN
338**

Č.p. specifikace

19802
1

Č.p.	obsah sady	Č.p.	obsah sady
19673	Ø 1,00 mm 20x	19728	Ø 6,50 mm 20x
19678	Ø 1,50 mm 20x	19733	Ø 7,00 mm 10x
19683	Ø 2,00 mm 20x	19738	Ø 7,50 mm 10x
19688	Ø 2,50 mm 20x	19743	Ø 8,00 mm 10x
19693	Ø 3,00 mm 30x	19748	Ø 8,50 mm 10x
19695	Ø 3,20 mm 30x	19753	Ø 9,00 mm 10x
19698	Ø 3,50 mm 30x	19758	Ø 9,50 mm 10x
19701	Ø 3,80 mm 30x	19763	Ø 10,00 mm 10x
19703	Ø 4,00 mm 30x	19768	Ø 10,50 mm 10x
19705	Ø 4,20 mm 30x	19772	Ø 11,00 mm 10x
19708	Ø 4,50 mm 30x	19776	Ø 11,50 mm 10x
19711	Ø 4,80 mm 30x	19781	Ø 12,00 mm 10x
19713	Ø 5,00 mm 20x	19783	Ø 12,50 mm 10x
19718	Ø 5,50 mm 20x	19786	Ø 13,00 mm 5x
19723	Ø 6,00 mm 20x		

VRTÁK DO KOVU PRODLOUŽENÝ

FESTA

W 4%, Mo 3%
Cr 4%, V 1%

HSS

DIN
338

Č.p.	specifikace	10	Č.p.	specifikace	10
20220	Ø 2,0 mm x 85 mm	10	20255	Ø 5,5 mm x 139 mm	10
20225	Ø 2,5 mm x 95 mm	10	20260	Ø 6,0 mm x 139 mm	10
20230	Ø 3,0 mm x 100 mm	10	20270	Ø 7,0 mm x 156 mm	10
20235	Ø 3,5 mm x 110 mm	10	20280	Ø 8,0 mm x 165 mm	10
20240	Ø 4,0 mm x 119 mm	10	20290	Ø 9,0 mm x 175 mm	10
20245	Ø 4,5 mm x 126 mm	10	20296	Ø 10,0 mm x 184 mm	10
20250	Ø 5,0 mm x 132 mm	10			

VRTÁK DO KOVU TIN

TiN

HSS

DIN
338

· titanový povrch pro zvýšení výkonu a životnosti

Č.p.	specifikace	1	Č.p.	specifikace	1	Č.p.	specifikace	1
20400	Ø 1,0 mm	1	20411	Ø 4,8 mm	1	20422	Ø 9,5 mm	1
20401	Ø 1,5 mm	1	20412	Ø 5,0 mm	1	20423	Ø 10,0 mm	1
20402	Ø 2,0 mm	1	20413	Ø 5,5 mm	1	20424	Ø 10,2 mm	1
20403	Ø 2,5 mm	1	20414	Ø 6,0 mm	1	20425	Ø 10,5 mm	1
20404	Ø 3,0 mm	1	20415	Ø 6,5 mm	1	20426	Ø 11,0 mm	1
20405	Ø 3,2 mm	1	20416	Ø 6,8 mm	1	20427	Ø 11,5 mm	1
20406	Ø 3,5 mm	1	20417	Ø 7,0 mm	1	20428	Ø 12,0 mm	1
20407	Ø 3,8 mm	1	20418	Ø 7,5 mm	1	20429	Ø 12,5 mm	1
20408	Ø 4,0 mm	1	20419	Ø 8,0 mm	1	20430	Ø 13,0 mm	1
20409	Ø 4,2 mm	1	20420	Ø 8,5 mm	1			
20410	Ø 4,5 mm	1	20421	Ø 9,0 mm	1			

VRTÁK DO KOVU

HSS

DIN
338

Č.p.	specifikace	10
19841	Ø 4,1 mm 5 ks	10
19842	Ø 4,2 mm 5 ks	10
19845	Ø 4,5 mm 5 ks	10
19885	Ø 8,5 mm 1 ks	10
19895	Ø 9,5 mm 1 ks	10

VRTÁKY DO KOVU VYBRUŠOVANÉ

FESTA

W 9%, Mo 3%
Cr 4%, V 1%

HSS

DIN
338

13x



Č.p. specifikace
20333 Ø 1,5 - 6,5 mm

1

VRTÁKY DO KOVU VYBRUŠOVANÉ

FESTA

W 9%, Mo 3%
Cr 4%, V 1%

HSS

DIN
338

19x



Č.p. specifikace
20334 Ø 1,0 - 10,0 mm

20

VRTÁKY DO KOVU VYBRUŠOVANÉ

FESTA

W 9%, Mo 3%
Cr 4%, V 1%

HSS

DIN
338

25x



Č.p. specifikace
20335 Ø 1,0 - 13,0 mm

5

VRTÁKY DO KOVU

FESTA

W 4%, Mo 3%
Cr 4%, V 1%

HSS

DIN
338

13x



Č.p. specifikace
20336 Ø 1,5 - 6,5 mm

1

VRTÁKY DO KOVU

FESTA

W 4%, Mo 3%
Cr 4%, V 1%

HSS

DIN
338

19x



Č.p. specifikace
20337 Ø 1,0 - 10,0 mm

20

VRTÁKY DO KOVU

FESTA

W 4%, Mo 3%
Cr 4%, V 1%

HSS

DIN
338

25x



Č.p. specifikace
20338 Ø 1,0 - 13,0 mm

10

SADA VRTÁKŮ

TiN

9x



Č.p. specifikace
20317 Ø 5-6-8 mm

FESTA

VRTÁKY S ŠESTIHRANNOU STOPKOU

FESTA

1/4"

HSS

7x



Č.p. specifikace
20316 Ø 1,5-2-3-4-5-5,5-6 mm



20

VRTÁKY DO KOVU

HSS

DIN 338

19x



Č.p. 20305 specifikace Ø 1,0 - 10,0 mm



25

VRTÁKY DO KOVU

HSS

DIN 338

25x



Č.p. 20311 specifikace Ø 1,0 - 13,0 mm



10

VRTÁKY DO KOVU

HSS

DIN 338

13x



Č.p. 20300 specifikace Ø 1,5 - 6,5 mm



50

VRTÁKY DO KOVU

HSS

DIN 338

19x



Č.p. 20310 specifikace Ø 1 - 13 mm



10

VRTÁKY DO KOVU

HSS

DIN 338

19x



Č.p. 20315 specifikace Ø 1 - 10 mm



10

VRTÁKY DO KOVU

TiN

HSS

DIN 338

19x



Č.p. 20320 specifikace Ø 1 - 10 x 0,5 mm



30

VRTÁKY DO KOVU

HSS

DIN 338

19x



Č.p. 20321 specifikace Ø 1 - 10 x 0,5 mm



5

OSTŘIČ VRTÁKŮ



Č.p. 20380 specifikace pro Ø 3,5 - 10 mm



20

VRTÁK STUPŇOVITÝ TIN

FESTA
TiN
HSS



Č.p.	specifikace	
20489	Ø 4 - 12 mm 8 stupňů	20
20490	Ø 4 - 20 mm 9 stupňů	10
20491	Ø 5 - 35 mm 13 stupňů	10
20492	Ø 7 - 40,5 mm 13 stupňů	5

VRTÁK STUPŇOVITÝ

HSS

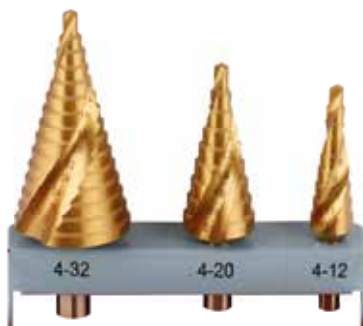

Č.p.	specifikace	
20487	Ø 4 - 20 mm 9 stupňů	10
20488	Ø 5 - 35 mm 13 stupňů	10
20494	Ø 4 - 32 mm 15 stupňů	10
20493	Ø 7 - 40,5 mm 13 stupňů	1

SADA STUPŇOVITÝCH VRTÁKŮ TIN

FESTA
TiN
HSS
3x

Č.p.	specifikace	
20495	Ø 4 - 12, 4 - 20, 4 - 32 mm	1

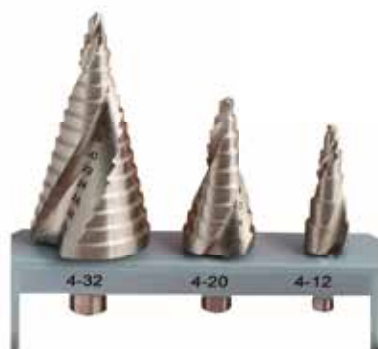
SADA STUPŇOVITÝCH VRTÁKŮ

HSS
3x

Č.p.	specifikace	
20496	Ø 4 - 12, 4 - 20, 4 - 32 mm	1

VYKRUŽOVACÍ KORUNKA BI-METAL

FESTA®

NEW

HSS



Č.p.	specifikace	
24419	Ø 19 mm	1
24420	Ø 20 mm	1
24422	Ø 22 mm	1
24425	Ø 25 mm	1
24429	Ø 29 mm	1
24432	Ø 32 mm	1
24435	Ø 35 mm	1
24437	Ø 37 mm	1
24444	Ø 44 mm	1
24451	Ø 51 mm	1
24457	Ø 57 mm	1
24464	Ø 64 mm	1
24476	Ø 76 mm	1
24483	Ø 83 mm	1

UNAŠEČ PRO VYKRUŽOVACÍ KORUNKY

FESTA®

NEW

14 - 30 mm



Č.p.	specifikace	
24410	pro korunky 14 - 30 mm	1

UNAŠEČ PRO VYKRUŽOVACÍ KORUNKY

FESTA®

NEW

32 - 152 mm



Č.p.	specifikace	
24411	pro korunky 32 - 152 mm	1

VYKRUŽOVACÍ KORUNKY BI-METAL - SADA

FESTA®

HSS

9x



Č.p.	specifikace	
24750	Ø 19, 22, 29, 38, 44, 57 mm	10

VYKRUŽOVACÍ KORUNKY BI-METAL - SADA

FESTA®

HSS

13x



Č.p.	specifikace	
24751	Ø 19, 22, 29, 35, 38, 44, 51, 57, 64 mm	10

VYTAHOVÁK ZALOMENÝCH ŠROUBŮ - SADA

8x

FESTA

- Ø 4 mm
- Ø 4,5 mm
- Ø 6,5 mm
- Ø 7,5 mm
- Ø 11 mm
- Ø 15 mm
- Ø 19 mm
- Ø 24 mm



Č.p. specifikace
20387

5

VYTAHOVÁK ZALOMENÝCH ŠROUBŮ - SADA

5x

FESTA

- Ø 4 mm
- Ø 4,5 mm
- Ø 6 mm
- Ø 7,5 mm
- Ø 11 mm



Č.p. specifikace
20386

10

VYTAHOVÁK ZALOMENÝCH ŠROUBŮ - SADA

5x

- Ø 4 mm
- Ø 4,5 mm
- Ø 6 mm
- Ø 7,5 mm
- Ø 11 mm



Č.p. specifikace
20385

10

DRŽÁK NA ZÁVITOVÁ OČKA

DIN 225



Č.p. specifikace
20396 25 x 9 mm

10

FESTA

VRATIDLO RÁČNOVÉ NA ZÁVITNÍKY



VRATIDLO STAVITELNÉ

DIN 1814



Č.p. specifikace
20395 1 - 1/2, M3 - M12

10

Č.p. specifikace
20397 M3 - M8



10

ZÁVITNÍKY A ZÁVITOVÁ OČKA SADA

32x

FESTA



Č.p. specifikace
20391 M 3, 4, 5, 6, 8, 10, 12 mm

1

ZÁVITNÍKY SADA

21x

FESTA



Č.p. specifikace
20390 M 3, 4, 5, 6, 8, 10, 12 mm

1

VRTÁK PŘÍKLEPOVÝ VIDIOVÝ

FESTA®

DIN
8039

· dvoubřitý vrták

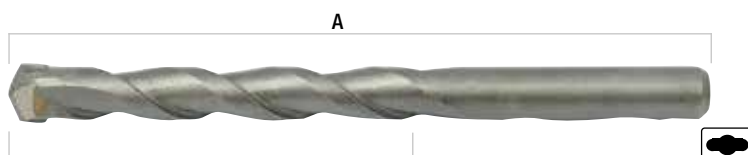

Č.p.	specifikace	A mm	B mm	
20673	Ø 3 mm	60	30	100
20674	Ø 4 mm	75	40	100
20675	Ø 5 mm	85	50	100
20676	Ø 6 mm	100	60	100
20677	Ø 6 mm	200	160	50
20685	Ø 6 mm	300	260	50

Č.p.	specifikace	A mm	B mm	
20678	Ø 8 mm	120	75	50
20686	Ø 8 mm	200	155	50
20687	Ø 8 mm	300	255	25
20688	Ø 8 mm	400	340	25
20680	Ø 10 mm	120	70	50
20690	Ø 10 mm	200	150	50
20691	Ø 10 mm	300	250	25
20692	Ø 10 mm	400	340	25
20682	Ø 12 mm	150	100	50
20694	Ø 12 mm	300	250	25
20696	Ø 12 mm	400	340	25
20684	Ø 14 mm	150	90	25
	redukce Ø 10 mm			
20697	Ø 14 mm	300	240	5
	redukce Ø 10 mm			
20698	Ø 14 mm	400	340	15
	redukce Ø 10 mm			

VRTÁK PŘÍKLEPOVÝ VIDIOVÝ SDS+

FESTA®

SDS+

· dvoubřitý vrták

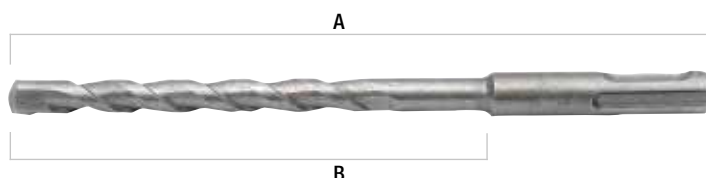

Č.p.	specifikace	A mm	B mm	
20855	Ø 14 mm	160	75	25

VRTÁK PŘÍKLEPOVÝ VIDIOVÝ SDS+

FESTA®

SDS+

· čtyřbřitý vrták se zvýšenou výkonností a trvanlivostí

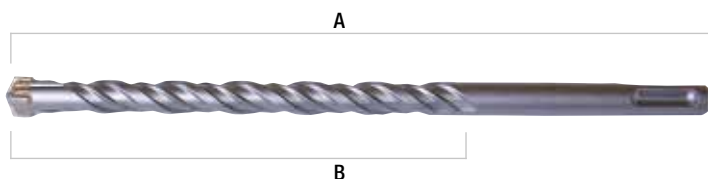

Č.p.	specifikace	A mm	B mm	
20748	Ø 6 mm	110	40	50
20749	Ø 6 mm	160	90	50
20750	Ø 6 mm	210	140	50
20751	Ø 6 mm	260	190	50
20861	Ø 6,5 mm	230	160	50
20862	Ø 6,5 mm	300	230	50
20752	Ø 8 mm	110	40	50
20753	Ø 8 mm	160	90	50
20754	Ø 8 mm	210	140	50
20755	Ø 8 mm	260	190	50
20825	Ø 8 mm	350	280	50
20756	Ø 10 mm	160	90	50
20757	Ø 10 mm	210	140	50
20758	Ø 10 mm	260	190	50
20759	Ø 10 mm	350	280	50
20760	Ø 10 mm	450	380	50

Č.p.	specifikace	A mm	B mm	
20761	Ø 10 mm	600	530	50
20762	Ø 10 mm	1000	930	50
20764	Ø 12 mm	160	80	50
20765	Ø 12 mm	210	130	50
20766	Ø 12 mm	260	180	50
20767	Ø 12 mm	350	270	50
20768	Ø 12 mm	460	380	50
20769	Ø 12 mm	600	520	25
20770	Ø 12 mm	1000	920	25
20771	Ø 14 mm	160	80	25
20772	Ø 14 mm	260	180	25
20773	Ø 14 mm	350	270	25
20774	Ø 14 mm	460	380	25
20775	Ø 14 mm	600	520	25
20776	Ø 14 mm	1000	920	30
20777	Ø 16 mm	160	80	25

Č.p.	specifikace	A mm	B mm	
20778	Ø 16 mm	210	130	25
20779	Ø 16 mm	260	180	25
20780	Ø 16 mm	350	270	25
20781	Ø 16 mm	460	380	25
20782	Ø 16 mm	600	520	30
20783	Ø 16 mm	1000	920	25
20784	Ø 18 mm	260	180	25
20785	Ø 18 mm	450	370	25
20786	Ø 18 mm	600	520	32
20787	Ø 18 mm	1000	920	20
20788	Ø 20 mm	450	370	20
20789	Ø 20 mm	600	520	20
20790	Ø 20 mm	800	720	25
20791	Ø 20 mm	1000	920	10
20792	Ø 22 mm	450	365	20
20793	Ø 22 mm	600	520	20
20794	Ø 22 mm	800	715	20
20795	Ø 22 mm	1000	920	10
20796	Ø 24 mm	450	365	10
20797	Ø 24 mm	600	520	20
20798	Ø 24 mm	800	715	10
20799	Ø 24 mm	1000	920	10
20870	Ø 26 mm	450	370	10
20871	Ø 26 mm	650	570	20
20872	Ø 26 mm	800	720	10
20873	Ø 26 mm	1000	920	10
20874	Ø 28 mm	450	365	10
20875	Ø 28 mm	600	565	20
20876	Ø 28 mm	800	715	10
20877	Ø 28 mm	1000	915	10
20878	Ø 30 mm	450	365	10
20879	Ø 30 mm	600	565	20
20880	Ø 30 mm	800	715	10
20881	Ø 30 mm	1000	915	10

VRTÁK PŘÍKLEPOVÝ VIDIOVÝ SDS MAX

FESTA
SDS MAX

• čtyřbřitý vrták se zvýšenou výkonností a trvanlivostí

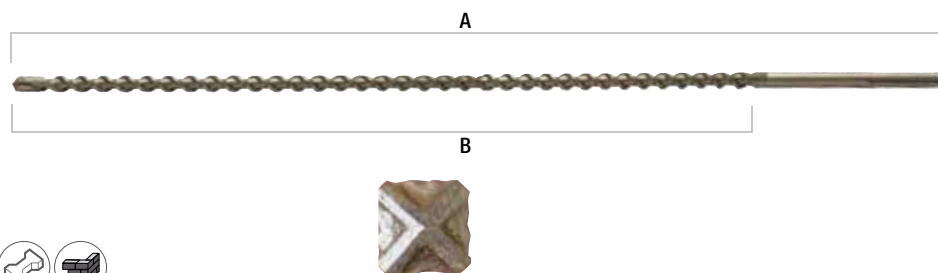

Č.p.	specifikace	A mm	B mm	
20510	Ø 18 mm	550	395	5
20520	Ø 18 mm	800	650	5
20511	Ø 20 mm	550	395	5
20521	Ø 20 mm	800	650	5
20512	Ø 22 mm	550	395	5
20522	Ø 22 mm	800	650	5
20513	Ø 24 mm	550	395	5
20523	Ø 24 mm	800	650	5
20514	Ø 28 mm	550	395	5
20524	Ø 28 mm	800	650	5
20515	Ø 30 mm	550	395	5
20525	Ø 30 mm	800	650	5
20516	Ø 40 mm	550	395	2
20526	Ø 40 mm	800	650	1



SADA VRTÁKŮ DO ZDIVA SDS+

SDS+
5x

Č.p.	specifikace	
20890	Ø 5, 6, 8, 10, 12 mm 160 mm	25

SADA VRTÁKŮ DO ZDIVA SDS+

SDS+
6x

Č.p.	specifikace	
20891	Ø 5, 6, 8 mm 110 mm Ø 8, 10, 12 mm 160 mm	25

STOJAN PREZentační



Č.p.	specifikace	
20999		1

SADA VRTÁKŮ DO ZDIVA

DIN 8039
6x

Č.p.	specifikace	
20895	Ø 5, 6, 8, 10, 12 mm	25

SEKÁČE A VRTÁKY SDS+

SDS+
17x

 • 2 x špičák
 • 3 x sekáč
 • 12 x vrták

Č.p.	specifikace	
20952		1

SADA VRTÁKŮ DO ZDIVA



Č.p.	specifikace	
20805	5 ks Ø 4 - 10 mm	10
20820	8 ks Ø 3 - 10 mm	10

SEKÁČE A VRTÁKY SDS+

SDS+
12x

 • 1 x špičák 250 mm
 • 1 x drážkovač 22 x 250 mm
 • 1 x plochý 20 x 250 mm

Č.p.	specifikace	
20950		5

 Ø 5 x 110 mm
 Ø 6 x 110 mm
 Ø 8 x 160 mm
 Ø 10 x 160 mm
 Ø 12 x 160 mm
 Ø 14 x 210 mm
 Ø 16 x 210 mm
 Ø 18 x 310 mm
 Ø 20 x 450 mm

SEKÁČE SADA

FESTA®

SDS+

4x



40 mm

20 mm



Č.p.	specifikace
20954	250 mm

1

SEKÁČ PLOCHÝ, ZAHNUTÝ 15°

FESTA®

SDS+

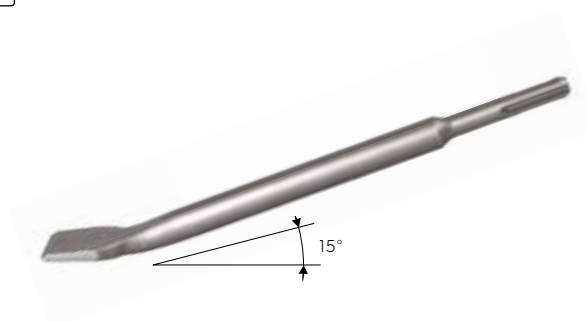

15°



Č.p.	specifikace
20936	40 x 250 mm

5

SEKÁČ

FESTA®

SDS
MAX

Č.p.	specifikace
20940	25 x 280 mm
20941	40 x 280 mm
20942	75 x 280 mm
20943	25 x 400 mm
20944	40 x 400 mm
20945	25 x 600 mm
20946	50 x 600 mm

5

5

5

5

5

5

5

5

SEKÁČ

FESTA®

SDS+



Č.p.	specifikace
20948	20 x 250 mm
20990	20 x 400 mm
20949	40 x 250 mm
20991	40 x 400 mm

25

25

25

25

ŠPIČÁK

FESTA®

SDS
MAX

Č.p.	specifikace
20937	Ø 18 x 280 mm
20938	Ø 18 x 400 mm
20939	Ø 18 x 600 mm

5

5

2

ŠPIČÁK

FESTA®

SDS+



Č.p.	specifikace
20947	250 mm
20992	400 mm

25

25

STOPKA UPÍNACÍ PRO VYKRUŽOVACÍ KORUNKY

FESTA®

SDS
MAX

Č.p.	specifikace
24730	180 mm

1

DRÁŽKOVAC

FESTA®

SDS+



Č.p.	specifikace
20956	22 x 250 mm

25

STOPKA UPÍNACÍ PRO VYKRUŽOVACÍ KORUNKY

FESTA®

SDS+



24731

24732



Č.p.	specifikace
24731	300 mm
24732	

1

1

ADAPTÉR SDS MAX NA SDS +

SDS
MAX

SDS+



Č.p.	specifikace
20744	

1

KORUNKA VYKRUŽOVACÍ S SK PLÁTKY

SDS+

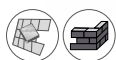

korunky je možné použít se stopkami 24730, 24731 a 24732

Č.p.	specifikace	
24719	Ø 67 mm	1
24717	Ø 73 mm	1
24723	Ø 80 mm	1
24718	Ø 100 mm	1
24757	NEW Ø 115 mm	1
24758	NEW Ø 125 mm	1
24759	NEW Ø 150 mm	1

VYKRUŽOVÁK STAVITELNÝ



Č.p.	specifikace	
24725	Ø 20-95mm	10

VYKRUŽOVÁK STAVITELNÝ S KRYTEM



Č.p.	specifikace	
24726	Ø 20-95mm	1

VYKRUŽOVACÍ KORUNKY KARBIDOVÉ - SADA

8x

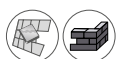

Č.p.	specifikace	
24747	Ø 33, 53, 67, 73, 83 mm unašeč, vrták, pilník	1

KORUNKY VYKRUŽOVACÍ KARBIDOVÉ - SADA

6x



Č.p.	specifikace	
24745	Ø 33, 53, 67, 73 mm + unašeč, vrták	1

KORUNKA VYKRUŽOVACÍ KARBIDOVÁ

FESTA

KORUNKA VYKRUŽOVACÍ KARBIDOVÁ - SADA

FESTA

3x



Č.p.	specifikace	
24735	Ø 33 mm	1
24736	Ø 43 mm	1
24737	Ø 53 mm	1
24738	Ø 67 mm	1
24739	Ø 73 mm	1
24740	Ø 83 mm	1
24741	Ø 103 mm	1

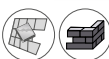

Č.p.	specifikace	
24746	Ø 103 mm + unašeč, vrták	1



UNAŠEČ PRO KORUNKY VYKRUŽOVACÍ

FESTA

VRTÁK PRO KORUNKY VYKRUŽOVACÍ

FESTA



Č.p.	specifikace	
24748	Ø 33 - 83 mm	10
24743	Ø 33 - 103 mm	10

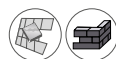

Č.p.	specifikace	
24749		50



PILNÍK NA OBKLADY A DLAŽBU



Č.p.	specifikace	
22200	200 mm	20



PILNÍK PLOCHÝ NA OBKLADY, DLAŽBU A ZDIVO



· pro broušení cihel před vložením stěnové kotvy

Č.p.	specifikace	
22201	200 mm dvojí hrubost	20



KORUNKA VRTACÍ DIAMANTOVÁ

FESTA

VODIČ NA VRTÁKY A VRTACÍ KORUNKY



Č.p.	specifikace	
24770	Ø 4 mm	1
24771	Ø 6 mm	1
24772	Ø 8 mm	1
24773	Ø 10 mm	1
24774	Ø 12 mm	1



· pro vrtání do skla a keramiky
· nutné chlazení



Č.p.	specifikace	
20379	Ø 4, 5, 6, 7, 8, 10, 12 mm	10



KORUNKA VYKRUŽOVACÍ DIAMANTOVÁ

M14

• použití bez chlazení vodou

 • keramické obklady
• mramor
• žula

• ukázkové video



Č.p.	specifikace	úchyt		Č.p.	specifikace	úchyt	
24760	Ø 6 mm	M14	1	24767	Ø 45 mm	M14	1
24761	Ø 8 mm	M14	1	24791	Ø 50 mm	M14	1
24762	Ø 10 mm	M14	1	24768	Ø 53 mm	M14	1
24763	Ø 12 mm	M14	1	24792	Ø 60 mm	M14	1
24764	Ø 14 mm	M14	1	24793	Ø 65 mm	M14	1
24790	Ø 20 mm	M14	1	24769	Ø 68 mm	M14	1
24765	Ø 28 mm	M14	1	24794	Ø 75 mm	M14	1
24766	Ø 35 mm	M14	1	24796	Ø 83 mm	NEW M14	1

KORUNKA VYKRUŽOVACÍ DIAMANTOVÁ

NEW

 • keramické obklady
• mramor
• žula

Č.p.	specifikace	
24700	Ø 6 mm	1
24701	Ø 8 mm	1
24702	Ø 10 mm	1
24703	Ø 12 mm	1
24704	Ø 14 mm	1
24705	Ø 20 mm	1

KORUNKA VYKRUŽOVACÍ DIAMANTOVÁ - SADA

NEW
6x

 • keramické obklady
• mramor
• žula

Č.p.	specifikace	
24798	Ø 6, 8, 10, 12, 14, 20 mm	1

KORUNKA BRUSNÁ DIAMANTOVÁ

M14

• použití bez chlazení vodou

 • keramické obklady
• mramor
• žula

Č.p.	specifikace	
24795	Ø 20 x 50 mm	1

VRTÁK NA SKLO A KERAMIKU

TiN

Č.p.	specifikace	
24780	Ø 4 mm	10
24781	Ø 5 mm	40
24782	Ø 6 mm	40
24783	Ø 8 mm	40
24784	Ø 10 mm	40
24785	Ø 12 mm	40
24786	NEW Ø 14 mm	1
24787	NEW Ø 16 mm	1
24788	NEW Ø 18 mm	1
24789	NEW Ø 20 mm	1

SEKÁČE, DŮLČÍKY, PRŮBOJNÍKY - SADA

FESTA

SEKÁČE, DŮLČÍKY A PRŮBOJNÍKY - SADA

FESTA

CrV



12x



CrV

6x





 2, 6, 8 mm
 10, 12, 16 mm
 Ø 1,5-3-4-5-6-8 mm

Č.p. specifikace

19487



4

 2 x 140, 8 x 115 mm
 12 x 152, 10 x 142 mm
 Ø 3 x 152, 6 x 152 mm

Č.p. specifikace

19486



10

SEKÁČE - SADA

FESTA

SEKÁČ ZÁMEČNICKÝ KŘÍŽOVÝ

FESTA

CrV

3x



 10, 12, 16 mm

Č.p. specifikace

19485



10

Č.p. specifikace

19429 200 mm



1

SEKÁČ PLOCHÝ

FESTA

SEKÁČ ZÁMEČNICKÝ PLOCHÝ

CrV

CrV



Č.p. specifikace

Č.p.	specifikace		
19410	200 mm	20 mm	10
19411	250 mm	25 mm	10
19412	300 mm	25 mm	10
19418	400 mm	25 mm	5
19419	500 mm	25 mm	5



Č.p. specifikace

19436 200 mm 20 mm



15

PRŮBOJNÍKY - SADA

FESTA

CrV

6x



Č.p.	specifikace
19483	Ø 3, 4, 5, 6, 7, 8 mm



5

PRŮBOJNÍKY - SADA

FESTA

CrV

6x



Č.p.	specifikace
19482	Ø 3, 4, 5, 6, 8 mm



5

PRŮBOJNÍK

FESTA

CrV



Č.p.	specifikace
19472	Ø 4 mm 150 mm
19473	Ø 5 mm 150 mm
19474	Ø 6 mm 150 mm



1

1

1

PRŮBOJNÍKY - SADA

FESTA

CrV

3x



Č.p.	specifikace
19480	Ø 0,8, 1,5, 2,5 mm



10

DŮLČÍK

FESTA

CrV



Č.p.	specifikace
19477	Ø 2,5 mm



20

DŮLČÍKY - SADA

FESTA

CrV

3x



Č.p.	specifikace
19481	Ø 0,8, 1,5, 2,5 mm



10

DŮLČÍK AUTOMATICKÝ

FESTA

CrV



Č.p.	specifikace
19478	Ø 2,5 mm



12

ŘEZAČ SKLA



Č.p.	specifikace
20350	130 mm



12

VRTÁK HADOVITÝ DO DŘEVA

FESTA®



Č.p.	specifikace		Č.p.	specifikace	
20980	Ø 6 x 230 mm	1	20984	Ø 16 x 230 mm	1
20957	Ø 6 x 300 mm	1	20899	Ø 16 x 300 mm	1
20981	Ø 8 x 230 mm	1	20917	Ø 16 x 450 mm	1
20958	Ø 8 x 300 mm	1	20922	Ø 16 x 600 mm	1
20982	Ø 10 x 230 mm	1	20918	Ø 18 x 450 mm	1
20896	Ø 10 x 300 mm	1	20923	Ø 18 x 600 mm	1
20913	Ø 10 x 450 mm	1	20919	Ø 20 x 450 mm	1
20983	Ø 12 x 230 mm	1	20924	Ø 20 x 600 mm	1
20897	Ø 12 x 300 mm	1	20724	Ø 22 x 450 mm	1
20915	Ø 12 x 450 mm	1	20725	Ø 24 x 450 mm	1
20920	Ø 12 x 600 mm	1	20726	Ø 26 x 450 mm	1
20898	Ø 14 x 300 mm	1	20727	Ø 28 x 450 mm	1
20916	Ø 14 x 450 mm	1	20728	Ø 30 x 450 mm	1
20921	Ø 14 x 600 mm	1			



VRTÁKY HADOVITÉ DO DŘEVA - SADA

FESTA®

5x



Č.p.	specifikace
20911	Ø 8, 10, 12, 14, 16 x 460 mm



10

VRTÁKY HADOVITÉ DO DŘEVA - SADA

FESTA®

6x



Č.p.	specifikace
20912	Ø 6, 8, 10, 12, 16, 20 x 230 mm



10

VRTÁK DO DŘEVA



Č.p.	specifikace		Č.p.	specifikace		Č.p.	specifikace	
20729	Ø 6 x 400 mm	1	20732	Ø 12 x 400 mm	1	20734	Ø 16 x 400 mm	1
20731	Ø 8 x 400 mm	1	20738	Ø 12 x 600 mm	1	20740	Ø 16 x 600 mm	1
20736	Ø 8 x 600 mm	1	20733	Ø 14 x 400 mm	1	20735	Ø 18 x 400 mm	1
20730	Ø 10 x 400 mm	1	20739	Ø 14 x 600 mm	1	20741	Ø 18 x 600 mm	1
20737	Ø 10 x 600 mm	1						

VRTÁK DO DŘEVA



Č.p.	specifikace	
21440	Ø 4 x 75 mm	1
21441	Ø 5 x 85 mm	1
21442	Ø 6 x 90 mm	1
21443	Ø 7 x 105 mm	1
21444	Ø 8 x 115 mm	1
21445	Ø 9 x 120 mm	1
21446	Ø 10 x 120 mm	1



Č.p.	specifikace	
20910	8 ks Ø 3, 4, 5, 6, 7, 8, 9, 10 mm	10
20905	5 ks Ø 4, 5, 6, 8, 10 mm	10



10



VRTÁK FRÉZOVACÍ

HSS

TiN



Č.p. specifikace
20460 Ø 6 mm

50

VRTÁKY FRÉZOVACÍ - SADA

HSS

TiN

6x



Č.p. specifikace
20450 Ø 3, 4, 5, 6, 6.5, 8 mm

20

VRTÁK NA KONFIRMÁTY - VYBRUŠOVANÝ

FESTA

HSS

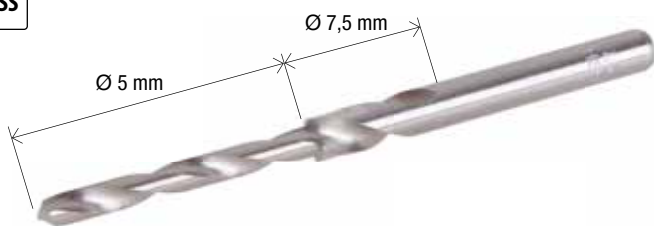

1

Č.p. specifikace
20210 Ø 7.5, 5 mm

SUKOVNÍKY - SADA

5x



Č.p. specifikace
21530 Ø 15, 20, 25, 35 mm Ø 8 mm

20

VRTÁKY KOPINATÉ DO DŘEVA - SADA

6x



Č.p. specifikace
20901 Ø 10, 12, 16, 18, 20, 25 mm

20

TVAROVÉ FRÉZY DO DŘEVA

5x



Č.p. specifikace
21450 Ø 8 mm

1

TVAROVÉ FRÉZY DO DŘEVA

12x



Č.p. specifikace
21451 Ø 8 mm

TVAROVÉ FRÉZY DO DŘEVA

24x



Č.p. specifikace
21452 Ø 8 mm



1

TVAROVÉ FRÉZY DO DŘEVA

35x



Č.p. specifikace
21453 Ø 8 mm



1

TVAROVÉ FRÉZY DO DŘEVA

59x



Č.p. specifikace
21454 Ø 8 mm



1

ROTAČNÍ RAŠPLE

5x



6 mm  12 mm

Č.p. specifikace
21541



25

ROTAČNÍ BRUSKY

5x



Č.p. specifikace
21540 Ø 3 mm, 6 mm



12

NÁSTAVCE NA PŘÍMOU BRUSKOU

100x



Č.p. specifikace
24755



5

NÁSTAVCE NA PŘÍMOU BRUSKOU

150x



Č.p. specifikace
24756

1

PILY VYKRUŽOVACÍ

FESTA

12x

Ø 19 mm
 Ø 22 mm
 Ø 25 mm
 Ø 35 mm
 Ø 44 mm
 Ø 51 mm
 Ø 60 mm
 Ø 67 mm
 Ø 76 mm
 Ø 82 mm
 inbus | hex key
 2x hlavička | head



Č.p.	specifikace
24712	6 tpi



20

VYKRUŽOVACÍ PILA NA DŘEVO A SÁDROKARTON

FESTA



Č.p.	specifikace	
24715	1' Ø 67 mm 6 tpi	5
24713	1' Ø 73 mm 6 tpi	5
24714	1' Ø 102 mm 6 tpi	5
24720	1' Ø 152 mm 6 tpi	5

PILY VYKRUŽOVACÍ

FESTA

8x

Ø 64 mm
 Ø 76 mm
 Ø 89 mm
 Ø 102 mm
 Ø 127 mm
 inbus
 hlavička



Č.p.	specifikace
24706	6 tpi

20

VYKRUŽOVACÍ PILY - SADA



Č.p.	specifikace	
24721	1' Ø 26, 32, 38, 45, 50, 56, 63 mm	10
24722	2' Ø 26, 32, 38, 45, 50, 56, 63 mm	10

VYKRUŽOVÁK STAVITELNÝ



Č.p.	specifikace
24716	Ø 30 - 120 mm



5



NEBOZEZY - SADA

4x

HOBBY



Č.p.	specifikace
20381	Ø 2, 3, 4, 5 mm

20

ADAPTÉR SDS MAX NA SDS +

SDS MAX → SDS+



Č.p. specifikace
20744



1

ADAPTÉR SDS +

SDS+



Č.p. specifikace
20745



1

SKLÍČIDLO

1/2"

FESTA



Č.p. specifikace
20960 1-13 mm + 2 klíče, 1/2 - 20 UNF 3
20966 náhradní klíček 25



SKLÍČIDLO RYCHLOUPÍNACÍ

1/2"

FESTA



Č.p. specifikace
20965 1,5 - 13 mm 1/2' - 20 UNF 1



SKLÍČIDLO RYCHLOUPÍNACÍ

1/2"



Č.p. specifikace
20961 1,5 - 13 mm 1/2' - 20 UNF 1



NÁSTAVEC NA VRTÁNÍ 90°



Č.p. specifikace
20365 Ø 1,5 - 10 mm 10



SKLÍČIDLO RYCHLOUPÍNACÍ DO AKU

1/4"



Č.p. specifikace
20963 Ø 1 - 6 mm 10



RAZNICE ČÍSLA



Č.p. specifikace
20972 6 mm 5
20973 8 mm 5



VÝSEČNÍKY

13x



Č.p. specifikace
24695 Ø 5, 6, 8, 10, 11, 13, 16, 19, 22, 25, 28, 32, 35 mm 5



DĚROVAČE

24690 - Ø 2,5 mm
Ø 3 mm
Ø 4 mm
Ø 5 mm
Ø 6 mm
Ø 7 mm
Ø 8 mm
Ø 9 mm
Ø 10 mm

24691 - Ø 2mm
Ø 2,5 mm
Ø 3,2 mm
Ø 4 mm
Ø 4,8 mm
Ø 5 mm
Ø 6,4 mm
Ø 8 mm
Ø 9,5 mm
Ø 11,1 mm
Ø 12,7 mm
Ø 14 mm
Ø 15,8 mm
Ø 19 mm
Ø 22 mm



Č.p. specifikace
24690 9 ks Ø 2,5 - 10 mm 10
24691 15 ks Ø 2 - 22 mm 5



RAZNICE ABECEDA



Č.p. specifikace
20970 6 mm 5
20971 8 mm 5



FESTA®



KARTÁČ MISKOVÝ, VLNITÝ, POMOSAZENÝ

M14

FESTA

KARTÁČ MISKOVÝ, VLNITÝ, POMOSAZENÝ

M14

FESTA

KARTÁČ MISKOVÝ, VLNITÝ, MOSAZNÝ

M14

FESTA



20mm



· pomosazený

Č.p.	specifikace	drát	
21900	Ø 100 mm M14	s 0,3	60
21902	Ø 125 mm M14	s 0,3	42



10mm



· pomosazený

Č.p.	specifikace	drát	
22001	Ø 100 mm M14	s 0,3	60
21901	Ø 125 mm M14	s 0,3	42



· mosazný



Č.p.	specifikace	drát	
21920	Ø 100 mm M14	s 0,3	60

KARTÁČ HRNKOVÝ, VLNITÝ, POMOSAZENÝ

M14

FESTA

KARTÁČ HRNKOVÝ, VLNITÝ, MOSAZNÝ

M14

FESTA

KARTÁČ OKRUŽNÍ, VLNITÝ, POMOSAZENÝ

M14

FESTA



· pomosazený



Č.p.	specifikace	drát	
21903	Ø 65 mm M14	s 0,3	60
22002	Ø 75 mm M14	s 0,3	80
21904	Ø 85 mm M14	s 0,3	60
22003	Ø 100 mm M14	s 0,3	36
21905	Ø 125 mm M14	s 0,3	24
21906	Ø 150 mm M14	s 0,3	12



· mosazný



Č.p.	specifikace	drát	
21925	Ø 75 mm M14	0,3 mm	80
21926	Ø 100 mm M14	0,3 mm	36

· redukční kroužky



· pomosazený



Č.p.	specifikace	drát	
22007	Ø 100 mm Ø 20 mm	s 0,3	60
22008	Ø 125 mm Ø 20 mm	s 0,3	42
22009	Ø 150 mm Ø 32,2 mm	s 0,3	32
22010	Ø 175 mm Ø 32,2 mm	s 0,3	20
22011	Ø 200 mm Ø 32,2 mm	s 0,3	20

KARTÁČ HRNKOVÝ, COPY

M14

FESTA



· patentované



Č.p.	specifikace	drát	
22004	Ø 65 mm M14	s 0,3	60
22005	Ø 75 mm M14	s 0,3	24
22006	Ø 100 mm M14	s 0,3	24
21907	Ø 125 mm M14	s 0,3	24
21908	Ø 150 mm M14	s 0,3	12

KARTÁČ HRNKOVÝ, COPY - NEREX

INOX

FESTA

M14



· patentované



Č.p.	specifikace	drát	
22037	Ø 65 mm M14	s 0,5	60
22038	Ø 80 mm M14	s 0,5	24

KARTÁČ RADIÁLNÍ, COPY

M14

FESTA



· patentované



Č.p.	specifikace	drát	počet copů	
21911	Ø 100 mm M14	s 0,5	30	60
21912	Ø 115 mm M14	s 0,5	32	42
21913	Ø 125 mm M14	s 0,5	36	42
21914	Ø 150 mm M14	s 0,5	40	32

KARTÁČ RADIÁLNÍ, COPY

M14

FESTA



· patentované



Č.p.	specifikace	drát	
22012	Ø 100 mm M14	s 0,5	60
22013	Ø 115 mm M14	s 0,5	42
22014	Ø 125 mm M14	s 0,5	42
22015	Ø 150 mm M14	s 0,5	32
22016	Ø 178 mm M14	s 0,5	20

KARTÁČ RADIÁLNÍ, COPY

INOX

FESTA

M14



· patentované



Č.p.	specifikace	drát	
22039	Ø 100 mm M14	s 0,5	60
22040	Ø 125 mm M14	s 0,5	42

KARTÁČ MISKOVÝ, COPY

M14

FESTA



· patentované



Č.p.	specifikace	drát	
22017	Ø 100 mm M14	s 0,5	60
21909	Ø 115 mm M14	s 0,5	42
21910	Ø 125 mm M14	s 0,5	42

KARTÁČ OKRUŽNÍ, COPY, STOPKA

FESTA



· patentované



Č.p.	specifikace	drát	
22023	Ø 75 mm	s 0,5	10

KARTÁČ HRNKOVÝ, COPY, STOPKA

FESTA



· patentované



Č.p.	specifikace	drát	
22024	Ø 75 mm	s 0,5	12

KARTÁČ MISKOVÝ, COPY, STOPKA

FESTA



· patentované



Č.p.	specifikace	drát	
22025	Ø 75 mm	s 0,5	12

KARTÁČ OKRUŽNÍ, VLNITÝ, POMOSAZENÝ

FESTA



pomosazený



Č.p.	specifikace	drát	
22026	Ø 50 mm	s 0,3	15
22027	Ø 63 mm	s 0,3	15
22028	Ø 75 mm	s 0,3	10
22029	Ø 100 mm	s 0,3	15

KARTÁČ HRNKOVÝ, VLNITÝ, POMOSAZENÝ

FESTA



pomosazený



Č.p.	specifikace	drát	
22030	Ø 65 mm	s 0,3	12
22031	Ø 75 mm	s 0,3	12

KARTÁČ KONCOVÝ, COPY, STOPKA

FESTA



patentované



Č.p.	specifikace	drát	
22021	Ø 19 mm	s 0,5	30
22022	Ø 22 mm	s 0,5	25

KARTÁČ KONCOVÝ, VLNITÝ, STOPKA

FESTA



Č.p.	specifikace	drát	
22058	Ø 12 mm	s 0,3	25
22059	Ø 25 mm	s 0,3	25

KARTÁČ KONCOVÝ, VLNITÝ, POMOSAZENÝ

FESTA



pomosazený



Č.p.	specifikace	drát	
22018	Ø 12 mm	s 0,3	15
22019	Ø 17 mm	s 0,3	15
22020	Ø 25 mm	s 0,3	25

KARTÁČ OKRUŽNÍ, NYLONOVÝ

FESTA

M14



Č.p.	specifikace	drát	
21930	Ø 125 mm	M14 1,2 mm	10
21931	Ø 150 mm	M14 1,2 mm	15

KARTÁČ HRNKOVÝ, VLNITÝ, NYLONOVÝ

FESTA

M14



Č.p.	specifikace	drát	
21940	Ø 75 mm	M14 1,2 mm	1
21941	Ø 100 mm	M14 1,2 mm	1

KARTÁČ OKRUŽNÍ, NYLONOVÝ, STOPKA

FESTA



Č.p.	specifikace	drát	
21935	Ø 50 mm	1,2 mm	1
21936	Ø 75 mm	1,2 mm	1
21937	Ø 100 mm	1,2 mm	1

KARTÁČ OKRUŽNÍ, NYLONOVÝ, STOPKA

FESTA

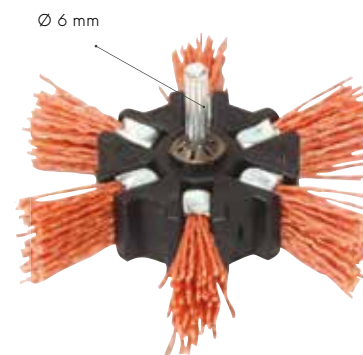

Č.p.	specifikace	drát	
22032	Ø 100 mm	1,2 mm	12

ŠTĚTEC DRÁTĚNÝ



Č.p.	specifikace	drát	
22158	200 mm	ocel	1
22159	200 mm	mosaz	1

KARTÁČ VLNITÝ



Č.p.	specifikace	drát	
22035	270 mm	ocel	24
22036	270 mm	nerez	24

KARTÁČ OCELOVÝ



Č.p.	specifikace	řady	
22033	300 mm	4 řady	12
22034	300 mm	5 řad	12

KARTÁČ POMOZAZENÝ



Č.p.	řady	
22078	3 řady	20

KARTÁČ POMOZAZENÝ



Č.p.	specifikace	řady	
22079	300 mm	4 řady	6

KARTÁČ OCELOVÝ



Č.p.	specifikace	řady	
22080	270 mm	5 řad	12

FESTA®

KARTÁČ MOSAZNÝ



Č.p.	specifikace	řady	
22082	300 mm	5 řad	12

FESTA®

KARTÁČE OCELOVÉ, POMOZAZENÉ - SADA

3x



Č.p.	řady	
22081	3 řady	12



KARTÁČE - SADA

3x



Č.p.	specifikace	
22086	180 mm	12

nylon, nerez, mosaz



KOTOUČ DIAMANTOVÝ LEŠTICÍ Ø 100 MM, SE SUCHÝM ZIPEM

FESTA

UNAŠEČ BRUSNÉHO PAPIŘU SE SUCHÝM ZIPEM

FESTA



M14



- M14 | Ø 8 mm
- EVA 10 mm



Č.p.	specifikace	
22062	Ø 115 mm	25
22063	Ø 125 mm	25
22064	Ø 150 mm	10



- keramické obklady | ceramic tiles
- sklo | glass
- mramor | marble
- žula | granite



Č.p.	hrubost	
22701	50	1
22702	100	1
22703	200	1
22704	400	1
22705	800	1
22706	1500	1
22707	3000	1

UNAŠEČ PRO FIBROVÝ KOTOUČ

M14

FESTA

NORTON
MADE IN EU



Č.p.	specifikace	
22073	Ø 125 mm, M14	1
22074	Ø 150 mm, M14	1

UNAŠEČ DIAMANTOVÝCH LEŠTICÍCH KOTOUČŮ

M14



- pro úhlovou brusku



Č.p.	specifikace	
22043	Ø 100 mm se suchým zipem	1

UNAŠEČ BRUSNÉHO PAPIŘU

M14



- pro úhlovou brusku



Č.p.	specifikace	
22044	Ø 125 mm M14 se suchým zipem	15
22060	Ø 150 mm M14 se suchým zipem	6

ADAPTÉR

NEW

M14

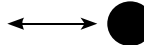

Č.p.	specifikace	
22087		1

UNAŠEČ BRUSNÉHO PAPIŘU KLOUBOVÝ



Č.p.	specifikace	stopka shank	
22061	Ø 125 mm se suchým zipem	Ø 8 mm	6

UNAŠEČ BRUSNÉHO PAPIŘU



Č.p.	specifikace	
22041	Ø 125 mm upínání šroubem	11
22042	Ø 125 mm se suchým zipem	11

KOTOUČ LEŠTÍCÍ, BERÁNEK



Č.p.	specifikace	specifikace	
22065	Ø 125 mm	se suchým zipem	20
22066	Ø 150 mm	se suchým zipem	20

KOTOUČ LEŠTÍCÍ, BERÁNEK S LÍMCEM



Č.p.	specifikace	specifikace	
22068	Ø 125 mm		20
22069	Ø 150 mm		20

FILC LEŠTÍCÍ SE SUCHÝM ZIPEM

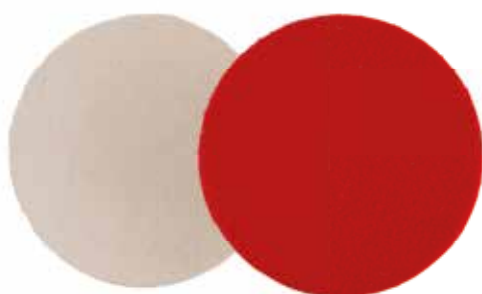

Č.p.	specifikace	specifikace	
22070	Ø 115 mm		20
22071	Ø 125 mm	se suchým zipem	20
22072	Ø 150 mm		20

KOTOUČ NYLONOVÝ, BRUSNÝ



Ø 6 mm



Č.p.	specifikace	specifikace	
22091	Ø 50 mm	P240	1
22092	Ø 75 mm	P240	1
22093	Ø 100 mm	P240	1

KOTOUČ BRUSNÝ UNIVERZÁLNÍ

NEW



Č.p.	specifikace	specifikace	
21798	Ø 125 mm Ø 22,2 mm		1

KOTOUČ NYLONOVÝ, STOPKA



Ø 6 mm



Č.p.	specifikace	specifikace	
22088	Ø 65 mm		9
22090	Ø 100 mm		5

KARTÁČ NYLON



Č.p.	specifikace	specifikace	
22083	Ø 115 mm Ø 22,2 mm		10
22084	Ø 125 mm Ø 22,2 mm		10
22085	Ø 150 mm Ø 22,2 mm		10

KOTOUČ NYLONOVÝ



Č.p.	specifikace	specifikace	
22095	Ø 178 mm		1

KOTOUČ FIBROVÝ - Ø 125 MM

3x



Č.p.	hrubost	
22160	P40	1
22161	P60	1
22162	P80	1
22163	P100	1
22164	P120	1

KOTOUČ FIBROVÝ - Ø 150 MM

3x



Č.p.	hrubost	
22165	P40	1
22166	P60	1
22167	P80	1
22168	P100	1
22169	P120	1

PAPÍR BRUSNÝ Ø 125 MM, SE SUCHÝM ZIPEM

3x



Č.p.	hrubost	
22045	P40	1
22046	P60	1
22047	P80	1
22048	P100	1
22049	P120	1
22050	P150	1
22051	P180	1
22052	P220	1

PAPÍR BRUSNÝ Ø 150 MM, SE SUCHÝM ZIPEM

3x



Č.p.	hrubost	
22053	P40	1
22054	P60	1
22055	P80	1
22056	P100	1
22057	P120	1

VIBRAČNÍ VÝSEK - 94 X 94 X 94 MM

5x



Č.p.	hrubost	
21831	P60	1
21832	P80	1
21834	P120	1

PAPÍR BRUSNÝ SE SUCHÝM ZIPEM - 125 MM

3x



Č.p.	hrubost	
22096	P40	20
22097	P60	20
22098	P80	20
22099	P120	20

NEKONEČNÝ BRUSNÝ PÁS - 75 X 533 MM

3x



Č.p.	hrubost	
21810	P40	20
21811	P60	20
21812	P80	20
21813	P100	20
21814	P120	20

PAPÍR BRUSNÝ 93 X 230 MM

5x



PAPÍR BRUSNÝ 115 X 280 MM

5x



Č.p.	hrubost	počet otvorů	
21740	P40	8	20
21741	P60	8	20
21742	P80	8	20
21743	P100	8	20
21744	P120	8	20

Č.p.	hrubost	počet otvorů	
21750	P40	10	20
21751	P60	10	20
21752	P80	10	20
21753	P100	10	20
21754	P120	10	20

PLÁTNO BRUSNÉ 230 X 280 MM

10x



PAPÍR BRUSNÝ VODĚODOLNÝ 230 X 280 MM

10x



PAPÍR BRUSNÝ 230 X 280 MM

10x



Č.p.	hrubost	
21732	P40	1
21734	P60	1
21735	P80	1
21736	P100	1
21737	P120	1

Č.p.	hrubost	
21701	P60	1
21702	P80	1
21703	P100	1
21704	P120	1
21705	P150	1
21706	P180	1
21709	P240	1

Č.p.	hrubost	
21715	P40	1
21716	P60	1
21717	P80	1
21718	P100	1
21719	P120	1
21720	P150	1
21721	P180	1
21724	P240	1

DRŽÁK BRUSNÉHO PAPÍRU

FESTA

DRŽÁK BRUSNÉHO PAPÍRU



DRŽÁK BRUSNÉHO PAPÍRU GUMOVÝ

rychloupínací
buková rukojeť

Č.p.	specifikace	
22067	170 x 70 mm	10

Č.p.	specifikace	
22075	210 x 105 mm	100
22076	160 x 85 mm	100

Č.p.	specifikace	
22077	125 x 68 mm	10

HOUBA DIAMANTOVÁ BRUSNÁ

FESTA

90 x 55 x 25 mm



- keramické obklady
- sklo
- mramor
- žula

Č.p.	hrubost	
22115	P60	10
22116	P120	10
22117	P200	10

BRUSNÝ LAMELOVÝ KOTOUČ NA STOPCE



Č.p.	hrubost	specifikace	
21850	P40		1
21851	P60		1
21852	P80	20 x 20, Ø 6 mm	1
21853	P100		1
21854	P120		1
21855	P40		1
21856	P60		1
21857	P80	30x30, Ø 6mm	1
21858	P100		1
21859	P120		1
21860	P40		1
21861	P60		1
21862	P80	60x30, Ø 6mm	1
21863	P100		1
21864	P120		1

HOUBA BRUSNÁ 100 X 70 X 28 MM - ZKOSENÁ

FESTA

NEW



Č.p.	hrubost	
22106	P 60	10
22107	P 80	10
22108	P 100	10
22109	P 120	10

HOUBA BRUSNÁ 100 X 70 X 25 MM

FESTA



Č.p.	hrubost	
22100	P60	20
22101	P80	20
22102	P100	20
22103	P120	20
22104	P180	20
22105	P220	20

HOUBA BRUSNÁ 120 X 95 X 10 MM

FESTA

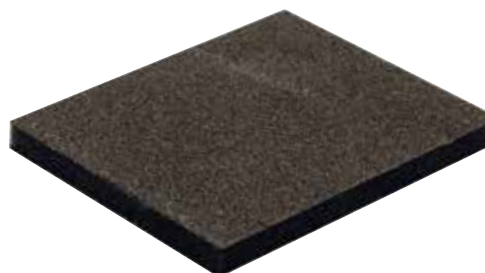

Č.p.	hrubost	
22110	P80	20
22111	P120	20
22112	P180	20
22113	P220	20

NÁŘADÍ NA SÁDROKARTON



RAŠPLE NA SÁDROKARTON



Č.p.	specifikace	
22120	250 x 40 mm	10

RAŠPLE NA SÁDROKARTON



Č.p.	specifikace	
22121	250 x 40 mm	10
22122	140 x 40 mm	6

RAŠPLE NA SÁDROKARTON



Č.p.	specifikace	
22126	155 x 40 mm	1

RAŠPLE NA SÁDROKARTON



Č.p.	specifikace	
22125	Ø 250 x 40 mm	6

RAŠPLE NA SÁDROKARTON



Č.p.	specifikace	
22124	Ø 250 x 16 mm	10

RAŠPLE NA SÁDROKARTON



Č.p.	specifikace	
22123	60 x 40 mm	6

PILKA NA SÁDROKARTON

FESTA®



Č.p.	specifikace	
24159	150 mm	12

HOBLÍK NA SÁDROKARTON

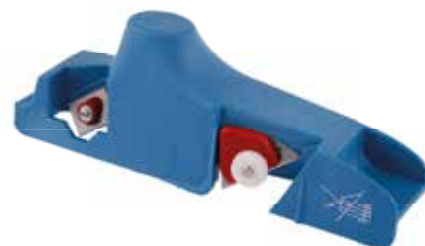

Č.p.	specifikace	
34315		10
34316	náhradní břit	1

PILKA VRTACÍ NA SÁDROKARTON



Č.p.	specifikace	
24190	270 mm	10

RAŠPLE NÁHRADNÍ



Č.p.	specifikace	
22130	250 x 40 mm	20
22129	155 x 40 mm	20
22132	140 x 40 mm	20
22133	60 x 40 mm	20
22134	Ø 16 x 250 mm	20



RAŠPLE A PILNÍKY

PILNÍK ČTYŘHRANNÝ

FESTA



Č.p.	specifikace	hrubost	
22184	250 mm	2	10

PILNÍK TROJHRANNÝ

FESTA



Č.p.	specifikace	hrubost	
22183	250 mm	2	10

PILNÍK TROJHRANNÝ NA PILOVÉ ZUBY

FESTA



Č.p.	specifikace	hrubost	
22178	150 mm	1	10

PILNÍKY - SADA

FESTA



5x



Č.p.	specifikace	hrubost	
22209	150 mm	2	10
22186	250 mm	2	5

PILNÍK PLOCHÝ

FESTA



Č.p.	specifikace	hrubost	
22206	150 mm	2	10
22180	250 mm	2	10

PILNÍK PŮLKULATÝ

FESTA



Č.p.	specifikace	hrubost	
22207	150 mm	2	10
22182	250 mm	2	10

PILNÍK KULATÝ

FESTA



Č.p.	specifikace	hrubost	
22181	250 mm	2	10

PILNÍKY - SADA

FESTA



3x



Č.p.	specifikace	hrubost	
22208	150 mm	2	10
22185	250 mm	2	5

RAŠPLE PLOCHÁ

FESTA



Č.p.	specifikace	
22202	150 mm	10
22197	300 mm	10

RAŠPLE KULATÁ

FESTA



Č.p.	specifikace	
22204	150 mm	10
22205	250 mm	10
22198	300 mm	10

RAŠPLE PŮLKULATÁ

FESTA



Č.p.	specifikace	
22203	150 mm	6
22199	300 mm	6

RAŠPLE SADA

FESTA



3x



Č.p.	specifikace	
22195	300 mm	5

PILNÍK NA ŘETĚZOVOU PILU

FESTA



Č.p.	specifikace		Č.p.	specifikace	
22170	200 mm 3,5 mm	20	22173	200 mm 5 mm	10
22171	200 mm 4 mm	10	22174	200 mm 5,5 mm	10
22172	200 mm 4,5 mm	10			

PILNÍKY JEHLOVÉ - SADA

FESTA

10x



Č.p.	specifikace	
22188		20

SADA NA BROUŠENÍ ŘETĚŽŮ

FESTA



Č.p.	specifikace	
22190	300 mm	5

PILNÍKY DIAMANTOVÉ - SADA

FESTA

10x



Č.p.	specifikace	
22189		25

FESTA®



KOTOUČ PILOVÝ DO DŘEVA S SK PLÁTKY

FESTA

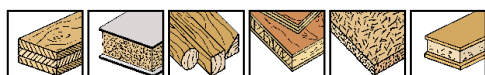

REDUKČNÍ KROUŽEK



Č.p.	specifikace	
22399	Ø 20 16 mm	1
22398	Ø 30 25 mm	1

Č.p.	specifikace	počet zubů	
	Ø 115 mm		
22300	Ø 115 x 22 mm	40	1
	Ø 125 mm		
22301	Ø 125 x 22 mm	40	1
	Ø 140 mm		
22302	Ø 140 x 20 mm	24	1
22303	Ø 140 x 20 mm	30	1
	Ø 150 mm		
22305	Ø 150 x 20 mm	24	1
	Ø 160 mm		
22307	Ø 160 x 20 mm	18	1
22309	Ø 160 x 20 mm	24	1
22310	Ø 160 x 20 mm	30	1
22311	Ø 160 x 20 mm	36	1
22312	Ø 160 x 20 mm	48	1
22313	Ø 160 x 20 mm	60	1
	Ø 165 mm		
22314	Ø 165 x 20 mm	24	NEW 1
	Ø 180 mm		
22315	Ø 180 x 30 mm	24	1
22317	Ø 180 x 30 mm	50	1
22318	Ø 180 x 20 mm	50	1
	Ø 190 mm		
22319	Ø 190 x 20 mm	40	1
22320	Ø 190 x 30 mm	40	1
	Ø 200 mm		
22322	Ø 200 x 30 mm	24	1
22324	Ø 200 x 30 mm	40	1
22326	Ø 200 x 30 mm	60	1
	Ø 205 mm		
22328	Ø 205 x 30 mm	40	1
22329	Ø 205 x 30 mm	60	1
	Ø 210 mm		
22332	Ø 210 x 30 mm	40	1
22333	Ø 210 x 30 mm	60	1
	Ø 250 mm		
22335	Ø 250 x 30 mm	40	1
22337	Ø 250 x 30 mm	60	1
	Ø 300 mm		
22340	Ø 300 x 30 mm	40	1
22343	Ø 300 x 30 mm	60	1
22345	Ø 300 x 30 mm	96	1
	Ø 350 mm		
22350	Ø 350 x 30 mm	40	1
22351	Ø 350 x 30 mm	54	1
	Ø 400 mm		
22355	Ø 400 x 30 mm	40	1
22357	Ø 400 x 30 mm	60	1
	Ø 500 mm		
22365	Ø 500 x 30 mm	60	1
	Ø 600 mm		
22370	Ø 600 x 30 mm	60	1

PROFESIONÁLNÍ PŘÍMOČARÉ PILKY

VYROBENO V NĚMECKU TECHNOLOGIÍ VYPALOVÁNÍM LASEREM

PILKA PŘÍMOČARÁ HSS - UCHYCENÍ AEG, BOSCH, FESTO, MAKITA, METABO

							
24060	50mm/1mm	0,7 mm/ 36TPI	31007	5 ks	10		
							
24061	50mm/1mm	1,2 mm/ 21TPI	31012	5 ks	10		
							
24062	50mm/1mm	2,0 mm/ 13TPI	31020	5 ks	10		
							
24063	75mm/1mm	3,0 mm/ 8TPI	31030	5 ks	10		
							
24064	100mm/1mm	1,2 mm/ 21TPI	31112	5 ks	10		
							
24065	100mm/1,3mm	2,0 mm/ 13TPI	31112	5 ks	10		
							
24066	75mm/1,45mm	2,0 mm/ 13TPI	31220	5 ks	10		
							
24067	120mm/1,3mm	1,8 - 2,4 mm/ 10 - 14 TPI	31220	5 ks	10		
							
24068	75mm/1,45mm	2,5 mm/ 10 TPI	32225	5 ks	10		
							
24069	75mm/1,45mm	4 mm/ 6 TPI	32240	5 ks	10		
							
24070	75mm/1,3mm	4 mm/ 6 TPI	32340	5 ks	10		
							
24071	75mm/1,3mm	4 mm/ 6 TPI	32440	5 ks	10		
							
24072	75mm/1,45mm	2,5 mm/ 10 TPI	32625	5 ks	10		
							
24073	85mm/1,45mm	3 mm/ 8 TPI	32730	5 ks	10		
							
24074	85mm/1,45mm	4 mm/ 6 TPI	32730	5 ks	10		
							
24075	75mm/1,45mm	2,5 1,2 mm/10 21 TPI	32825	5 ks	10		
							
24076	75mm/1,7mm	4 mm 6 TPI	32940	5 ks	10		
							
24077	120mm/1,3mm	4 mm 6 TPI	32040	5 ks	10		
							
24078	105mm/1,45mm	4 mm 6 TPI	34040	5 ks	10		
							
24055	55mm	karbidová		5 ks	1		



PILKA PŘÍMOČARÁ HSS - UCHYCENÍ BLACK & DECKER, FERM

Číslo	Velikost	Uchycení	TPI	Číslo	ks	Obrazky
24080	50mm 1,0 mm	1,2 21 TPI	11012	5 ks	10	
24081	75mm 1,0 mm	3,0 8 TPI	11030	5 ks	10	
24082	75mm 1,45 mm	2,5 10 TPI	12225	5 ks	10	
24083	75mm 1,45 mm	4 6 TPI	12240	5 ks	10	
24084	75mm 1,3 mm	4 6 TPI	12340	5 ks	10	
24085	50mm 1,0 mm	2,0 13 TPI	12420	5 ks	10	
24086	75mm 1,3 mm	4,0 6 TP	12440	5 ks	10	
24087	75mm 1,45 mm	2,5 10 TPI	12625	5 ks	10	



	měkká ocel (s malým obsahem uhlíku)		ocelový plech		nerezavějící ocel		laminovaná prkna
	neželezné kovy		tvrdé a měkké dřevo		dřevotřískka		plasty
	překlížka		laťová překlížka		dřevo s hřebíky		
	sendvičový materiál		dlažba a obklady		hliník		

SADA PŘÍMOČARÝCH PILEK

5x



Č.p.	specifikace	ks
24045	sada	50

STOJAN PŘÍMOČARÝCH PILEK



osazení stojanu 24098

24060	· 5 ks
24080	· 5 ks
24061	· 5 ks
24062	· 5 ks
24081	· 5 ks
24063	· 5 ks
24066	· 5 ks
24067	· 5 ks
24082	· 5 ks
24068	· 5 ks
24083	· 5 ks
24069	· 5 ks
24084	· 5 ks
24070	· 5 ks
24086	· 5 ks
24071	· 5 ks
24087	· 5 ks
24072	· 5 ks
24073	· 5 ks
24074	· 5 ks
24075	· 5 ks
24076	· 5 ks

Č.p.	specifikace	ks
24099	64 x 50 cm - prázdný	1
24098	64 x 50 cm - osazený	1

PILOVÝ PLÁTEK

FESTA®

HCS 3x

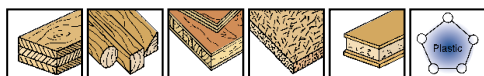

1

Č.p. specifikace
24301 150 x 19 x 1,3 mm TPI 6

PILOVÝ PLÁTEK

FESTA®

HCS 3x



1

Č.p. specifikace
24302 225 x 19 x 1,3 mm TPI 3

PILOVÝ PLÁTEK

FESTA®

HCS 3x

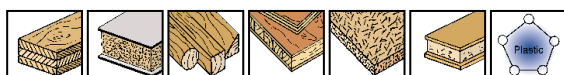

1

Č.p. specifikace
24303 200 x 19 x 1,3 mm TPI 6 - 10

PILOVÝ PLÁTEK

FESTA®

HCS 3x



1

Č.p. specifikace
24304 240 x 19 x 1,5 mm TPI 5

PILOVÝ PLÁTEK

FESTA®

Bi Metal 3x

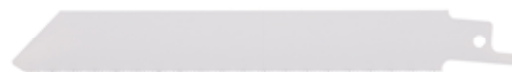
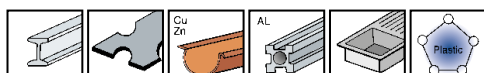

1

Č.p. specifikace
24305 150 x 19 x 1 mm TPI 24

PILOVÝ PLÁTEK

FESTA®

Bi Metal 3x

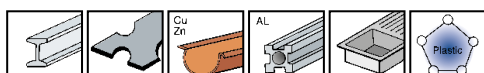

1

Č.p. specifikace
24306 150 x 19 x 1 mm TPI 9

PILOVÝ PLÁTEK

Bi
Metal **3x**

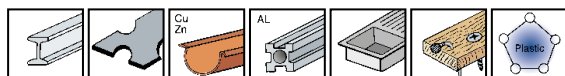

Č.p. specifikace

24308 225 x 19 x 1 mm TPI 10 - 14



1

PILOVÝ PLÁTEK

Bi
Metal **3x**

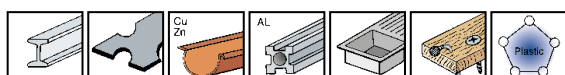

Č.p. specifikace

24310 150 x 22 x 1,6 mm TPI 9



1

PILOVÝ PLÁTEK

Bi
Metal **3x**

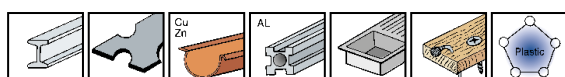

Č.p. specifikace

24313 225 x 22 x 1,6 mm TPI 6



1

PILA NA KOV HSS

HSS

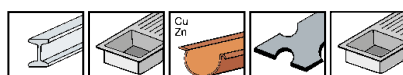

Č.p. specifikace

24050 203 x 19 x 1 mm TPI 10 - 14



25

PILOVÝ PLÁTEK

TC **3x** · SK zuby, dlouhá životnost

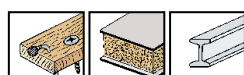

Č.p. specifikace

24312 225 x 19 x 1,3 mm TPI 6 - 9



1

PILOVÝ PLÁTEK

NEW

SK



Č.p. specifikace

24315 305 x 50 x 1,5 mm



1

SADA PILOVÝCH PLÁTKŮ

FESTA

Bi
Metal

HCS

3x

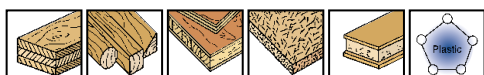

· 24301
· 24304
· 24305

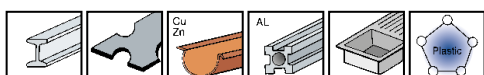

1

Č.p. specifikace
24314

PILOVÝ PLÁTEK



· kalené zuby

Č.p.	specifikace	
24185	533 mm	1
24186	610 mm	1
24187	760 mm	1
24188	800 mm	1
24189	914 mm	1

PILOVÝ PLÁTEK



· kalené zuby

Č.p.	specifikace	
24169	350 mm	10
24167	450 mm	10
24166	533 mm	10
24163	610 mm	10
24164	760 mm	10
24168	800 mm	10
24165	914 mm	10

PILOVÝ PLÁTEK



Č.p.	specifikace	
24195	rozteč 3 mm 300 mm	1
24196	rozteč 4 mm 300 mm šikmý zub	1
24197	rozteč 5 mm 300 mm kalený zub	1
24192	pilový list do řeznické pily 450 mm	1

PILOVÝ PLÁTEK



Č.p.	specifikace	
24160	rozteč 3 mm 300 mm	20
24161	rozteč 4 mm 300 mm	20
24162	rozteč 5 mm 300 mm	50

PILOVÝ PLÁTEK

10x



Č.p.	specifikace	
24108	6 mm 150 mm	1

ŘEZACÍ STRUNA



Č.p.	specifikace	
24120	300 mm	50

PILOVÝ PLÁTEK BI - METAL

FESTA



8 % COBALT



Č.p.	specifikace
24180	300 mm

125

PILOVÝ PLÁTEK

FESTA



Č.p.	specifikace		
24109	12,5 mm 300 mm	na kov	144
24118	25 mm 300 mm	na kov oboustranná	72
24119	25 mm 300 mm	na kov a dřevo	72

PILA NA KOV

FESTA



Č.p.	specifikace
24104	300 mm



6

PILA NA KOV

FESTA



· zesílený rám



Č.p.	specifikace
24102	300 mm



6

PILA NA KOV

FESTA



Č.p.	specifikace
24103	300 mm



6

PILA NA KOV



Č.p.	specifikace
24153	300 mm



12

PILA NA KOV

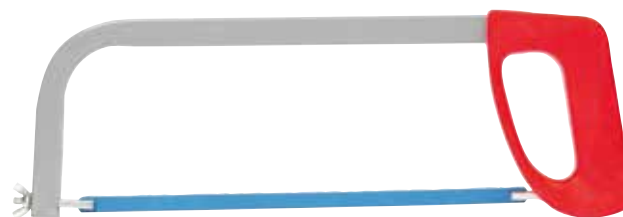

Č.p.	specifikace
24100	300 mm



12

PILA NA KOV

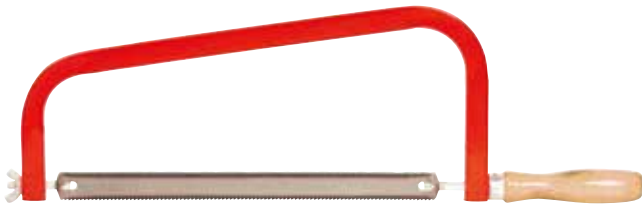

Č.p. specifikace
24170 300 mm

12

PILA NA KOV

FESTA®

MADE IN
EU

2x



Č.p. specifikace
24126 300 x 25 x 0,65 mm TPI 24 | 14

1

PILA NA KOV

· plátky 24108



Č.p. specifikace
24125 150 mm

6

PILA NA KOV

· plátky 24109



Č.p. specifikace
24124 260 mm

10

LUPÉNKOVÁ PILA

NEW

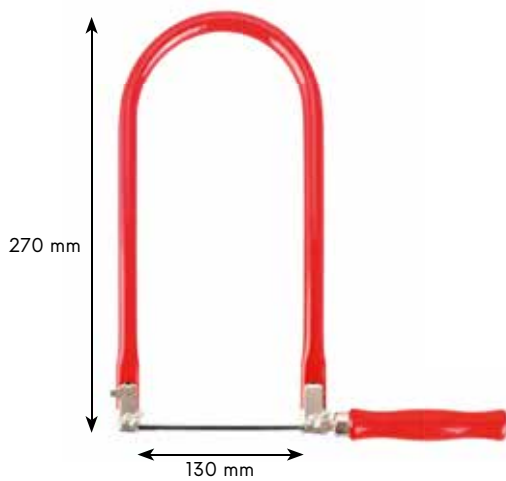

PILA

NEW

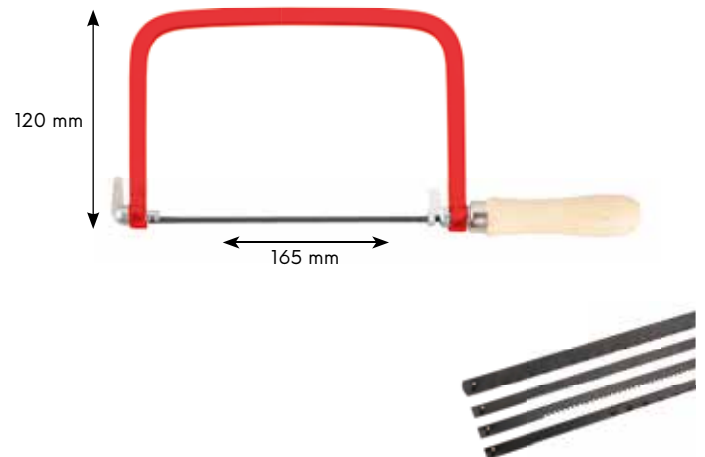

· 5x pilový plátek

Č.p. | No. specifikace
24121 pila
24110 pilový plátek

1
1

Č.p. | No. specifikace
24122 pila
24111 pilový plátek

1
1

PILA OCASKA



· 3 x broušené a kalené zuby

Č.p.	specifikace	
24143	300 mm	12
24144	400 mm	12
24145	500 mm	12

PILA ČEPOVKA



· 3 x broušené a kalené zuby

Č.p.	specifikace	
24147	300 mm	6

PILA DĚROVKA



· 3 x broušené a kalené zuby

Č.p.	specifikace	
24149	300 mm	12

PILA POKOSOVÁ PROFI

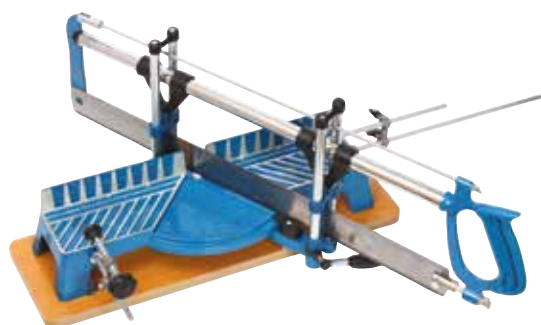

Č.p.	specifikace	
24130	600 mm	1
24131	600 mm, pilový plátek	1

POKOSNICE PLASTOVÁ



Č.p.	specifikace	
24133	300 x 140 mm	1

POKOSNICE DŘEVĚNÁ



· buk

Č.p.	specifikace	
24171	80 x 300 mm	10

KOSOŘEZ + PILA





Č.p.	specifikace	
24148	300 mm	12

PILA OBLOUKOVÁ

FESTA



• kalené zuby

Č.p.	specifikace		Č.p.	specifikace	
24141	450 mm	1	24136	760 mm	1
24140	533 mm	1	24142	800 mm	1
24135	610 mm	1	24137	914 mm	1

PILA OBLOUKOVÁ OTOČNÁ

FESTA



• kalené zuby

Č.p.	specifikace	
24173	350 mm	24

PILA ZAHRADNÍ



Č.p.	specifikace	
24151	300 mm	10

PILA ZAHRADNÍ - TULEJ



Č.p.	specifikace	
24154	300 mm	10

KOZA NA ŘEZÁNÍ DŘEVA

NEW

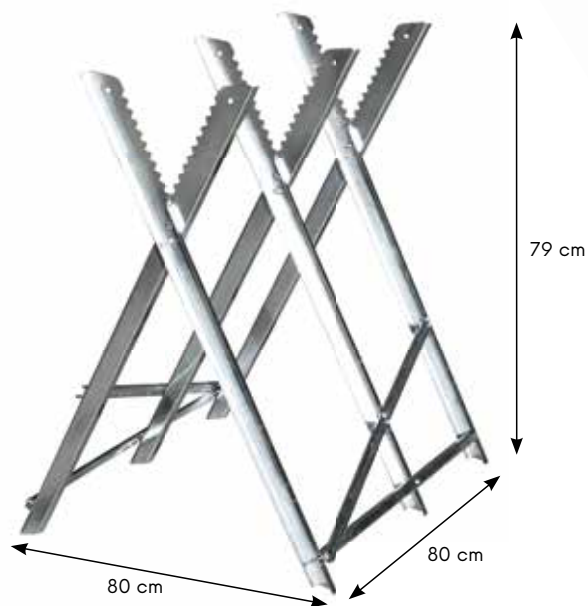

Č.p.	specifikace	
37570	max. 150 kg	1

PILA ZAHRADNÍ - OTOČNÁ

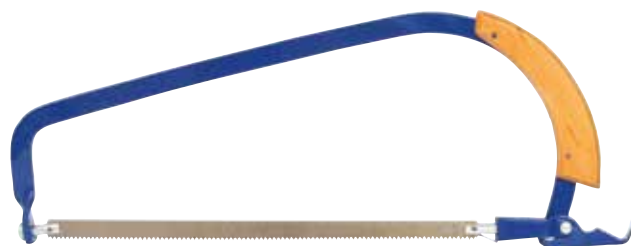

Č.p.	specifikace	
24150	300 mm	10

PILA

INOX



Č.p.	specifikace	
24128	450 mm plátky 24192	6

PILA ZAVÍRACÍ



• 3 x broušené a kalené zuby



Č.p.

specifikace

45061

150 mm s krytem rukojeti

12

PILA ZAVÍRACÍ



• 3 x broušené a kalené zuby



Č.p.

specifikace

45060

180 mm

6

PILA S POUZDREM



• 3 x broušené a kalené zuby



Č.p.

specifikace

45062

260 mm s pouzdem

24

PILA PROŘEZÁVACÍ



• 3 x broušené a kalené zuby



Č.p.

specifikace

24152

350 mm 7 tpi

12

PILA TELESKOPICKÁ PROŘEZÁVACÍ



• 3 x broušené a kalené zuby

Č.p.

specifikace

45033

230 - 490 mm

1

HOUSENICE S PILOU



Č.p.

specifikace

45030

pilka 30 cm

teleskopická tyč 260 cm

6

45031

pilka 30 cm

6

HOUSENICE



Č.p.

specifikace

45032

kovová housenice bez pilky

10

PILA NA POLYSTYREN

FESTA



Č.p.	specifikace	
24174	370 mm	1

PILKA NA SÁDROKARTON

FESTA



1 2 3 · 3 x broušené a kalené zuby



Č.p.	specifikace	
24159	150 mm	12

PILKA VRTACÍ NA SÁDROKARTON



Č.p.	specifikace	
24190	270 mm	10



PILA NA DUTÉ CIHLY (PORO-THERM)

FESTA



Č.p.	specifikace	
24181	550 mm	1

PILA NA POROBETON

FESTA



Č.p.	specifikace	
24158	22 22 SK zubů - 450 mm	5

PILA NA POROBETON

FESTA



Č.p.	specifikace	
24155	34 17 SK zubů - 630 mm	2
24156	34 34 SK zubů - 630 mm	2

PILA NA POROBETON

FESTA



Č.p.	specifikace	
24176	34 17 SK zubů - 750 mm	6
24177	34 34 SK zubů - 750 mm	6

PILA NA POROBETON

FESTA

MADE IN EU



· kalené zuby

Č.p.	specifikace	
24175	bez SK zubů - 600 mm EU	2
24178	bez SK zubů - 600 mm	6



Použití řezných diamantových kotoučů

materiály	festa industry	plný full	turbo	segment
cihla	••	••	••	••
obklady	••	•••	••	-
zdivo, kámen	••	••	••	••
beton	•••	•	•••	•••
železobeton	•••	-	•••	-
střešní tašky	••	•	••	••
sklo a keramika	-	•••	-	-
mramor	•	••	•	•
žula	•••	••	•••	••
pískovec	••	-	••	••
asfalt	-	••	-	••
křemen	••	•	••	•

KOTOUČ DIAMANTOVÝ



Č.p.	specifikace				
21200	Ø 115 mm	1,4 mm	Ø 22,2 mm	1	
21201	Ø 125 mm	1,4 mm	Ø 22,2 mm	1	
21204	Ø 200 mm	1,8 mm	Ø 25,4 mm	1	
21203	Ø 230 mm	1,8 mm	Ø 22,2 mm	1	



KOTOUČ DIAMANTOVÝ PLNÝ



Č.p.	specifikace			
21210	Ø 110 mm	Ø 22,2 mm	1	
21211	Ø 115 mm	Ø 22,2 mm	1	
21212	Ø 125 mm	Ø 22,2 mm	1	
21215	Ø 150 mm	Ø 22,2 mm	1	
21218	Ø 180 mm	Ø 22,2 mm	1	
21219	Ø 180 mm	Ø 25,4 mm	1	
21220	Ø 200 mm	Ø 25,4 mm	1	
21223	Ø 230 mm	Ø 22,2 mm	1	
21224	Ø 300 mm	Ø 25,4 mm	1	



KOTOUČ DIAMANTOVÝ SEGMENTOVÝ



Č.p.	specifikace			
21311	Ø 115 mm	Ø 22,2 mm	1	
21312	Ø 125 mm	Ø 22,2 mm	1	
21315	Ø 150 mm	Ø 22,2 mm	1	
21318	Ø 180 mm	Ø 22,2 mm	1	
21323	Ø 230 mm	Ø 22,2 mm	1	
21324	Ø 300 mm	Ø 25,4 mm	1	
21325	Ø 350 mm	Ø 25,4 mm	1	
21326	Ø 400 mm	Ø 25,4 mm	1	



KOTOUČ DIAMANTOVÝ TURBO

FESTA



Č.p.	specifikace		
21410	Ø 110 mm	Ø 22,2 mm	1
21411	Ø 115 mm	Ø 22,2 mm	1
21412	Ø 125 mm	Ø 22,2 mm	1
21415	Ø 150 mm	Ø 22,2 mm	1
21418	Ø 180 mm	Ø 22,2 mm	1
21423	Ø 230 mm	Ø 22,2 mm	1
21424	Ø 300 mm	Ø 25,4 mm	1



KOTOUČ DIAMANTOVÝ PLNÝ



Č.p.	specifikace		
21010	Ø 110 mm	Ø 22,2 mm	1
21011	Ø 115 mm	Ø 22,2 mm	1
21012	Ø 125 mm	Ø 22,2 mm	1
21015	Ø 150 mm	Ø 22,2 mm	1
21018	Ø 180 mm	Ø 22,2 mm	1
21023	Ø 230 mm	Ø 22,2 mm	1



KOTOUČ DIAMANTOVÝ SEGMENTOVÝ



Č.p.	specifikace		
21110	Ø 110 mm	Ø 22,2 mm	1
21111	Ø 115 mm	Ø 22,2 mm	1
21112	Ø 125 mm	Ø 22,2 mm	1
21115	Ø 150 mm	Ø 22,2 mm	1
21118	Ø 180 mm	Ø 22,2 mm	1
21123	Ø 230 mm	Ø 22,2 mm	1



KOTOUČ DIAMANTOVÝ TURBO



Č.p.	specifikace		
21130	Ø 110 mm	Ø 22,2 mm	1
21135	Ø 115 mm	Ø 22,2 mm	1
21140	Ø 125 mm	Ø 22,2 mm	1
21150	Ø 150 mm	Ø 22,2 mm	1
21180	Ø 180 mm	Ø 22,2 mm	1
21190	Ø 230 mm	Ø 22,2 mm	1



KOTOUČ DIAMANTOVÝ SEGMENTOVÝ, DVOJITÝ

FESTA

Č.p.	specifikace
21195	Ø 125 x 22,2 mm

KOTOUČ DIAMANTOVÝ BRUSNÝ DVOUŘÁDÝ

FESTA

Č.p.	specifikace
21430	Ø 115 mm Ø 22,2 mm
21431	Ø 125 mm Ø 22,2 mm
21432	Ø 150 mm Ø 22,2 mm

KOTOUČ DIAMANTOVÝ BRUSNÝ TURBO

FESTA

Č.p.	specifikace
21425	Ø 100 mm Ø 22,2 mm
21426	Ø 115 mm Ø 22,2 mm
21427	Ø 125 mm Ø 22,2 mm
21428	Ø 150 mm Ø 22,2 mm

KOTOUČ ŘEZNÝ UNIVERZÁLNÍ - DIAMANTOVÝ

FESTA

Č.p.	specifikace
21301	Ø 125 mm Ø 22,2 mm 1,8 mm
21303	Ø 230 mm Ø 22,2 mm 1,8 mm

KOTOUČ ŘEZNÝ NA KOV



Č.p.	specifikace		
22258	NEW Ø 115 mm Ø 22,2 mm x 0,8 mm		25
22263	Ø 115 mm Ø 22,2 mm x 1,6 mm		25
22264	Ø 115 mm Ø 22,2 mm x 2 mm		25
22259	NEW Ø 125 mm Ø 22,2 mm x 0,8 mm		25
22266	Ø 125 mm Ø 22,2 mm x 1 mm		25
22270	Ø 125 mm Ø 22,2 mm x 2 mm		25
22273	Ø 150 mm Ø 22,2 mm x 1,6 mm		25
22274	Ø 150 mm Ø 22,2 mm x 2 mm		25
22275	Ø 150 mm Ø 22,2 mm x 2,5 mm		25
22277	Ø 180 mm Ø 22,2 mm x 2 mm		25
22280	Ø 230 mm Ø 22,2 mm x 2 mm		25
22281	Ø 230 mm Ø 22,2 mm x 2,5 mm		25

KOTOUČ ŘEZNÝ NA HLINÍK



NEW



Č.p.	specifikace		
22285	Ø 115 mm Ø 22,2 mm x 1 mm		1
22286	Ø 125 mm Ø 22,2 mm x 1 mm		1

KOTOUČ ŘEZNÝ NA KOV



Č.p.	specifikace		
22211	Ø 115 mm Ø 22,2 mm x 1 mm	INOX	50
22212	Ø 115 mm Ø 22,2 mm x 1,2 mm	INOX	50
22225	Ø 125 mm Ø 22,2 mm x 1 mm	INOX	50
22217	Ø 125 mm Ø 22,2 mm x 1,2 mm	INOX	50
Č.p.	specifikace		
22251	Ø 115 mm Ø 22,2 mm x 1,6 mm		50
22215	Ø 115 mm Ø 22,2 mm x 2 mm		50
22216	Ø 115 mm Ø 22,2 mm x 2,5 mm		50
22252	Ø 125 mm Ø 22,2 mm x 1,6 mm		25
22218	Ø 125 mm Ø 22,2 mm x 2,5 mm		25
22219	Ø 150 mm Ø 22,2 mm x 1,2 mm		25
22253	Ø 150 mm Ø 22,2 mm x 1,6 mm		50
22220	Ø 150 mm Ø 22,2 mm x 2,5 mm		50
22254	Ø 180 mm Ø 22,2 mm x 1,6 mm		50
22222	Ø 180 mm Ø 22,2 mm x 2,5 mm		25
22255	Ø 230 mm Ø 22,2 mm x 1,6 mm		25
22224	Ø 230 mm Ø 22,2 mm x 2,5 mm		25

KOTOUČ BRUSNÝ NA KOV



Č.p.	specifikace		
22240	Ø 115 mm Ø 22,2 mm x 6,4 mm		25
22242	Ø 125 mm Ø 22,2 mm x 6,4 mm		25
22244	Ø 150 mm Ø 22,2 mm x 6,4 mm		25
22246	Ø 180 mm Ø 22,2 mm x 6,4 mm		25
22248	Ø 230 mm Ø 22,2 mm x 6,4 mm		25

KOTOUČ ŘEZNÝ NA KÁMEN



Č.p.	specifikace	
22294	Ø 230 mm Ø 22,2 mm x 3 mm	1

KOTOUČ ŘEZNÝ NA KÁMEN



Č.p.	specifikace	
22230	Ø 115 mm Ø 22,2 mm x 2,5 mm	50
22232	Ø 125 mm Ø 22,2 mm x 2,5 mm	50
22234	Ø 150 mm Ø 22,2 mm x 2,5 mm	25
22236	Ø 180 mm Ø 22,2 mm x 2,5 mm	25
22238	Ø 230 mm Ø 22,2 mm x 2,5 mm	25

KOTOUČ ŘEZNÝ NA KOV - DIAMANTOVÝ



Č.p.	specifikace	
21306	Ø 125 mm Ø 22,2 mm 1,3 mm	1
21308	Ø 230 mm Ø 22,2 mm 1,8 mm	1

KOTOUČ ŘEZNÝ UNIVERZÁLNÍ - KARBIDOVÝ



Č.p.	specifikace	
21192	Ø 125 mm Ø 22,2 mm	1
21194	Ø 230 mm Ø 22,2 mm	1

KOTOUČ LAMELOVÝ

FESTA®

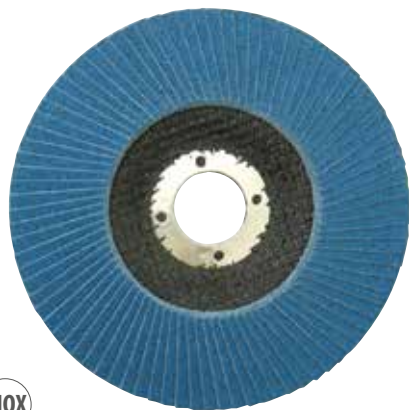

• brusný kotouč vhodný pro broušení nerez oceli

Č.p.	specifikace	hrubost	
22140	Ø 115 mm Ø 22,2 mm	P40	5
22141	Ø 115 mm Ø 22,2 mm	P60	5
22142	Ø 115 mm Ø 22,2 mm	P80	5
22143	Ø 115 mm Ø 22,2 mm	P100	5
22145	Ø 125 mm Ø 22,2 mm	P40	5
22146	Ø 125 mm Ø 22,2 mm	P60	5
22147	Ø 125 mm Ø 22,2 mm	P80	5
22148	Ø 125 mm Ø 22,2 mm	P100	5
22150	Ø 150 mm Ø 22,2 mm	P40	5
22151	Ø 150 mm Ø 22,2 mm	P60	5
22155	Ø 150 mm Ø 22,2 mm	P80	5
22156	Ø 150 mm Ø 22,2 mm	P100	5



KOTOUČ LAMELOVÝ



Č.p.	specifikace	hrubost	
21780	Ø 115 mm Ø 22,2 mm	P40	10
21781	Ø 115 mm Ø 22,2 mm	P60	10
21782	Ø 115 mm Ø 22,2 m	P80	10
21783	Ø 115 mm Ø 22,2 mm	P100	10
21784	Ø 115 mm Ø 22,2 mm	P120	10
21786	Ø 125 mm Ø 22,2 mm	P40	10
21787	Ø 125 mm Ø 22,2 mm	P60	10
21788	Ø 125 mm Ø 22,2 mm	P80	10
21789	Ø 125 mm Ø 22,2 mm	P100	10
21790	Ø 125 mm Ø 22,2 mm	P120	10
21792	Ø 150 mm Ø 22,2 mm	P40	10
21793	Ø 150 mm Ø 22,2 mm	P60	10
21794	Ø 150 mm Ø 22,2 mm	P80	10
21795	Ø 150 mm Ø 22,2 mm	P100	10
21796	Ø 150 mm Ø 22,2 mm	P120	10



KOTOUČ BRUSNÝ UNIVERZÁLNÍ



NEW



Č.p.	specifikace	
21798	Ø 125 mm Ø 22,2 mm	1

KOTOUČ RAŠPLOVÝ - STŘEDNĚ HRUBÝ

FESTA®

NEW



Č.p.	specifikace				
21802	Ø 125 mm	Ø 22,2 mm	3 mm		1

KOTOUČ RAŠPLOVÝ - HRUBÝ

FESTA®

NEW



Č.p.	specifikace				
21801	Ø 125 mm	Ø 22,2 mm	3 mm		1

KOTOUČ NA DŘEVO S OTVORY

FESTA®



• brusný kotouč vhodný pro broušení dřeva

Č.p.	specifikace				
21800	Ø 125 mm	Ø 22,2 mm			1



212

ZEDNICKÁ HLADÍTKA, LŽÍCE, ŠPACHTLE



222

ŠKRABÁKY A BRUSNÁ HLADÍTKA



225

HLADÍTKA A BRUSNÉ MŘÍŽKY



227

HLADÍTKA PRO ÚPRAVU OMÍTEK



233

ZEDNICKÉ NABĚRAČKY



234

MÍCHADLA



238

PRODLUŽOVACÍ KABELY



239

ELEKTRICKÁ A PLYNOVÁ TOPIDLA



240

STAVEBNÍ MÍCHAČKY



244

SHOZ STAVEBNÍ SUTI



244

STAVEBNÍ KOLEČKA

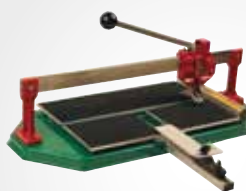

245

LÁMAČE DLAŽBY A NOSIČE OBRUB-
NÍKŮ

247

ŘEZAČKY DLAŽBY



250

POMŮCKY PRO POKLÁDÁNÍ DLAŽBY



253

NIVELACE



257

ŘEZAČKY NA POLYSTYREN



261

OMÍTAČKY



263

PB HOŘÁKY A REGULÁTORY TLAKU



267

ZEDNICKÉ NÁDOBY

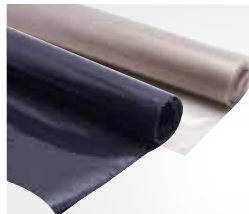

268

PYTLE NA SUŠ A ODPAD



269

LEPÍCÍ A MASKOVACÍ PÁSKY

STAVEBNÍ NÁŘADÍ 210 - 291



273

VYTLAČOVACÍ PISTOLE



275

PISTOLE NA PU PĚNU



276

HORKOVZDUŠNÉ A TAVNÉ PISTOLE



278

MALÍŘSKÉ POTŘEBY



284

PE PLACHTY



286

KARABINY, ŘETĚZY A OCELOVÉ LANA



289

STAVEBNÍ SVĚTLA



290

ŽEBŘÍKY



290

DVÍŘKA KOMÍNOVÁ A BEDNÍCÍ STOJKY



HLADÍTKA, LŽÍCE A ŠPACHTLE

HLADÍTKO NEREZ 280 X 130 MM

INOX

- gumová rukojeť

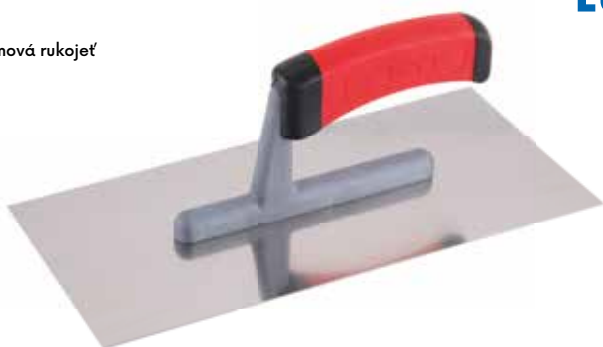

Č.p.	specifikace
31140	rovné



10

FESTA
MADE IN
EU

HLADÍTKO NEREZ 280 X 130 MM

INOX

- gumová rukojeť



Č.p.	specifikace
31148	rovné s oblými rohy



10

FESTA
MADE IN
EU

HLADÍTKO NEREZ 280 X 130 MM ZUBOVÉ

INOX

- gumová rukojeť



Č.p.	specifikace
31146	Ø 16



10

FESTA
MADE IN
EU

HLADÍTKO NEREZ 280 X 130 MM ZUBOVÉ

INOX

- gumová rukojeť



Č.p.	specifikace	Icon	Č.p.	specifikace	Icon
31141	e 4	10	31144	e 10	10
31142	e 6	10	31145	e 12	10
31143	e 8	10			

FESTA
MADE IN
EU

HLADÍTKO NEREZ 280 X 130 MM ZUBOVÉ

INOX



Č.p.	specifikace	Icon
31101	e 4	10
31111	e 6	10
31121	e 8	10

Č.p.	specifikace	Icon
31131	e 10	10
31132	e 12	10

FESTA
MADE IN
EU

HLADÍTKO NEREZ 280 X 130 MM

INOX



Č.p.	specifikace
31091	rovné



10

FESTA
MADE IN
EU

HLADÍTKO NERAZ 280 X 130 MM

INOX



Č.p.	specifikace	
31011	rovné	10

HLADÍTKO NERAZ 280 X 130 MM ZUBOVÉ

INOX



Č.p.	specifikace		Č.p.	specifikace	
31021	e 4	10	31051	e 10	10
31031	e 6	10	31053	e 12	10
31041	e 8	10			

HLADÍTKO NERAZ 270 X 125 MM

INOX



Č.p.	specifikace	
31005	rovné	25

HLADÍTKO NERAZ 270 X 125 MM ZUBOVÉ

INOX



Č.p.	specifikace		Č.p.	specifikace	
31006	e 4	24	31008	e 8	24
31007	e 6	24	31009	e 10	24

HLADÍTKO NERAZ 360 X 130 MM

INOX



Č.p.	specifikace	
31151	rovné	10

HLADÍTKO NERAZ 360 X 130 MM

INOX



Č.p.	specifikace	
31150	rovné	10

HLADÍTKO NERAZ 480 X 130 MM

INOX



Č.p.	specifikace	
31082	rovné	10

HLADÍTKO NERAZ 680 X 130 MM

INOX



Č.p.	specifikace	
31155	rovné	10

HLADÍTKO NEREZ 500 X 130 MM

FESTA

INOX



Č.p.	specifikace	
31081	rovné straight	10

HLADÍTKO NEREZ 500 X 130 MM ZUBOVÉ

FESTA

INOX



Č.p.	specifikace	
31052	e 4	10
31061	e 6	10
31062	e 8	10
31071	e 10	10
31072	e 12	10

LŽÍCE NEREZ

FESTA

INOX

· gumová rukojeť



Č.p.	specifikace		Č.p.	rozměry	
31232	120 mm	10	31234	160 mm	10
31233	140 mm	10	31235	180 mm	10

LŽÍCE NEREZ

FESTA

INOX



Č.p.	specifikace		Č.p.	specifikace	
31220	120 x 80 mm	10	31222	160 x 115 mm	10
31221	140 x 80 mm	10	31231	180 x 120 mm	10

LŽÍCE NEREZ OBLÁ

FESTA

INOX

· gumová rukojeť



Č.p.	specifikace	
31334	160 x 100 mm	10

LŽÍCE NEREZ OBLÁ

FESTA

INOX



Č.p.	specifikace	
31343	160 x 100 mm	10

LŽÍCE NEREZ VYMAZÁVACÍ

FESTA

INOX

· gumová rukojeť



Č.p.	specifikace		Č.p.	specifikace	
31360	40 mm	10	31400	100 mm	10
31380	60 mm	10	31403	120 mm	10
31390	80 mm	10			

LŽÍCE NEREZ VYMAZÁVACÍ

FESTA

INOX



Č.p.	specifikace		Č.p.	specifikace	
31362	40 mm	10	31392	80 mm	10
31382	60 mm	10	31402	100 mm	10
			31404	120 mm	10

LŽÍCE NEREZ KOČIČÍ JAZYK

FESTA

INOX

· gumová rukojeť



Č.p.	specifikace	
31330	140 x 50 mm	10
31340	160 x 60 mm	10

LŽÍCE NEREZ KOČIČÍ JAZYK

FESTA

INOX



Č.p.	specifikace	
31332	140 x 50 mm	10
31341	160 x 60 mm	10

LŽÍCE NEREZ KOUTOVÁ

FESTA

INOX

· gumová rukojeť



Č.p.	specifikace	
31280	80 x 60 x 60 mm	10

LŽÍCE NEREZ KOUTOVÁ

FESTA

INOX



Č.p.	specifikace	
31281	80 x 60 x 60 mm	10

LŽÍCE NEREZ ROHOVÁ

FESTA

INOX

· gumová rukojeť



Č.p.	specifikace	
31270	80 x 60 x 60 mm	10

LŽÍCE NEREZ ROHOVÁ

FESTA

INOX



Č.p.	specifikace	
31271	80 x 60 x 60 mm	10

LŽÍCE NEREZ POKRÝVAČSKÁ

FESTA

INOX

· gumová rukojeť



Č.p.	specifikace	
31320	140 x 75 mm	10

LŽÍCE NEREZ POKRÝVAČSKÁ

FESTA

INOX



Č.p.	specifikace	
31322	140 x 75 mm	10

LŽÍCE NEREZ ZUBOVÁ S HRANOU

FESTA

INOX



Č.p.	specifikace	
31218	180 mm e 6	12

ŠPACHTLE NEREZ

FESTA

INOX

- gumová rukojeť



Č.p.	specifikace		Č.p.	specifikace	
31510	40 mm	10	31513	100 mm	10
31511	60 mm	10	31514	120 mm	10
31512	80 mm	10	31515	140 mm	10

ŠPACHTLE NEREZ

FESTA

INOX



Č.p.	specifikace		Č.p.	specifikace	
31461	40 mm	12	31491	100 mm	12
31471	60 mm	12	31467	120 mm	12
31481	80 mm	12	31468	140 mm	12

ŠKRABKA NEREZ

FESTA

INOX

- gumová rukojeť



- zesílená čepel

Č.p.	specifikace	
32173	75 mm	10

ŠKRABKA NEREZ S TULEJÍ

INOX



- zesílená čepel
- vhodná násada 52010

Č.p.	specifikace	
32170	100 mm	12

ŠPACHTLE NEREZ S BITEM

FESTA

INOX

- gumová rukojeť



Č.p.	specifikace	
31455	150 mm	12
31456	200 mm	12

ŠPACHTLE NEREZ

FESTA

INOX



Č.p.	specifikace	
31498	150 mm	12
31499	200 mm	12
31500	100 mm	12



ŠPACHTLE NEREZ PRO CELOPLOŠNÉ TMELENÍ

FESTA
INOX

Č.p.	specifikace	
31555	35 cm	1
31556	45 cm	1
31557	60 cm	1

Č.p.	specifikace	
31558	80 cm	1
31559	100 cm	1

ŠTĚRKA NEREZ S VÝZTUŽÍ

FESTA
INOX

• gumová rukojeť



Č.p.	specifikace	
31505	200 mm	5
31506	250 mm	5
31507	300 mm	5

ŠTĚRKA NEREZ

INOX
MADE IN EU

Č.p.	specifikace	
31541	250 mm	1
31551	250 mm úzká	1

ŠPACHTLE NEREZ S VÝZTUŽÍ

MADE IN EU
NEW
INOX

Č.p.	specifikace	
31520	400 mm	1
31521	500 mm	
31522	600 mm	

PŘÍSLUŠENSTVÍ KE ŠPACHTLI S VÝZTUŽÍ

MADE IN EU
NEW

Č.p.	specifikace	
31523	držák ALU	1
31524	držák plastic	1
31525	držák KULOGRIF	1
31526	násada dřevěná s kovovým vnitřním závitem - 130cm	1

ŠPACHTLE NEREZ



INOX



Č.p.	specifikace	
31493	40 mm	20
31494	60 mm	20
31495	80 mm	20
31496	100 mm	20

STĚRKA NEREZ FASÁDNÍ

FESTA

INOX



Č.p.	specifikace	
31552	400 mm	10
31553	600 mm	10

ŠPACHTLE NEREZ MALÍŘSKÁ

FESTA

INOX



Č.p.	specifikace	
31497	63 x 195 mm	12

NŮŽ NEREZ TAPETÁŘSKÝ

FESTA

INOX



Č.p.	specifikace	
31503	150 mm	12

ŠKRABÁK MALÍŘSKÝ



ŠPACHTLE PRO SÁDROKARTONÁŘE



Č.p.	specifikace	
31501	100 mm	30
31502	náhradní břit	1



Č.p.	specifikace	
34308	50 mm	20
34307	80 mm	12
34306	100 mm	10
34305	150 mm	12

STĚRKA JAPONSKÁ

FESTA

4x

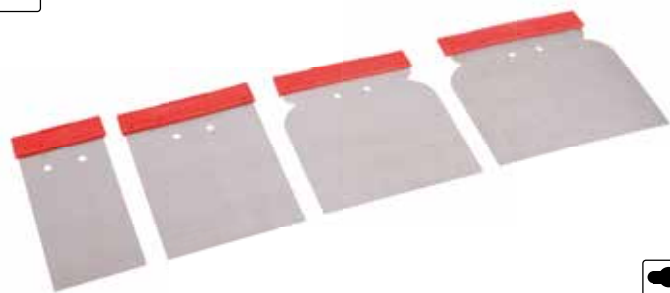

Č.p.	specifikace	
31452	neroz 50, 80, 100, 120 mm	10
31453	ocel 50, 80, 100, 120 mm	10

STĚRKA JAPONSKÁ, PLAST

FESTA



4x



Č.p.	specifikace	
31454	50, 80, 100, 120 mm	12

HLADÍTKO OCEL

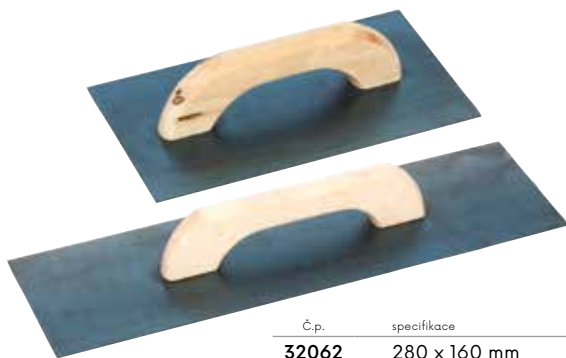

Č.p.	specifikace	
32062	280 x 160 mm	10
32076	400 x 100 mm	36
32060	500 x 140 mm	5

HLADÍTKO OCEL ŠPIČATÉ



Č.p.	specifikace	
32064	500 x 90 mm	5
32066	550 x 140 mm	5

LŽÍCE OCEL BROUŠENÁ



Č.p.	specifikace	
32015	160 x 130 mm	10
32014	180 x 130 mm	10
32016	200 x 140 mm	10

LŽÍCE OCEL



Č.p.	specifikace	
32001	160 x 110 mm	10
32002	160 x 130 mm	10
32003	180 x 130 mm	10
32013	200 x 140 mm	10

LŽÍCE OCEL OBLÁ



Č.p.	specifikace	
32018	160 x 110 mm	10

LŽÍCE VYMAZÁVACÍ OCEL



Č.p.	specifikace	
32024	140 x 80 mm	12

LŽÍCE KOČIČÍ JAZYK OCEL



Č.p.	specifikace	
32020	140 x 65 mm	12
32021	140 x 40 mm	12

LŽÍCE POKRÝVAČSKÁ OCEL





Č.p.	specifikace	
32026	140 x 85 mm	12

ŠPACHTLE OCEL



FESTA®



Č.p.	specifikace		Č.p.	specifikace	
32161	30 mm	10	32171	90 mm	10
32162	40 mm	10	32166	100 mm	10
32163	50 mm	10	32172	110 mm	10
32164	60 mm	10	32167	120 mm	10
32169	70 mm	10	32168	140 mm	10
32165	80 mm	10			

ŠPACHTLE OCEL



Č.p.	specifikace		Č.p.	specifikace	
32176	30 mm	12	32216	80 mm	12
32186	40 mm	12	32226	100 mm	12
32196	50 mm	12	32234	125 mm	12
32206	60 mm	12			

ŠKRABKA NA STĚNY A PODLAHY

FESTA®

INOX



· zesílená čepel

Č.p.	šířka	délka	
32174	100 mm	500 mm	1

SADA ŠPACHTLÍ OCEL

3x



Č.p.	specifikace	
32240	30, 50, 80 mm	10



STĚRKA OCELOVÁ



A1

A2

e4

Č.p.	specifikace	
31601	180 mm - rovná	1
31602	NEW 180mm A1	1
31603	NEW 180mm A2	1
31641	180 mm - e4	1



STĚRKA OCELOVÁ



e4

Č.p.	specifikace	
31651	250 mm - rovná	1
31655	250 mm - e4	1



STĚRKA PLASTOVÁ ZUBOVÁ



Č.p.	specifikace	
37101	150 x 80 mm	100
37111	170 x 115 mm	100



STĚRKA PLASTOVÁ



Č.p.	specifikace	
37051	rovná	1
37031	zub - 4 x 6 mm	1
37041	zub - 6 x 6 mm	1



LŽÍCE MODELOVACÍ OCEL



Č.p.	specifikace	
32022	140 x 80 mm	12
32023	125 x 40 mm	12



SPÁROVAČKA JEDNOSTRANNÁ



Č.p.	specifikace	
32040	10 mm	20
32041	12 mm	20
32042	15 mm	20
32043	18 mm	20
32044	20 mm	20



SPÁROVAČKA DVOUSTRANNÁ



Č.p.	specifikace	
32050	10 12 mm	50
32051	10 15 mm	50
32052	10 18 mm	50
32053	15 20 mm	50



DRÁŽKOVAC NA YTONG



Č.p.	specifikace	
32037	600 mm	1



ŠKRABÁK NA YTONG

FESTA



· topol

MOQ
2

Č.p.	specifikace
32317	450 x 95 mm

ŠKRABÁK NA YTONG - JEMNÝ ZUB

FESTA



· topol

MOQ
2

Č.p.	specifikace
32312	450 x 95 mm

ŠKRABÁK NA YTONG

FESTA



· topol

MOQ
2

Č.p.	specifikace
32337	260 x 95 mm

ŠKRABÁK NA BŘIZOLIT

FESTA



· topol

MOQ
2

Č.p.	specifikace
32327	230 x 145 mm

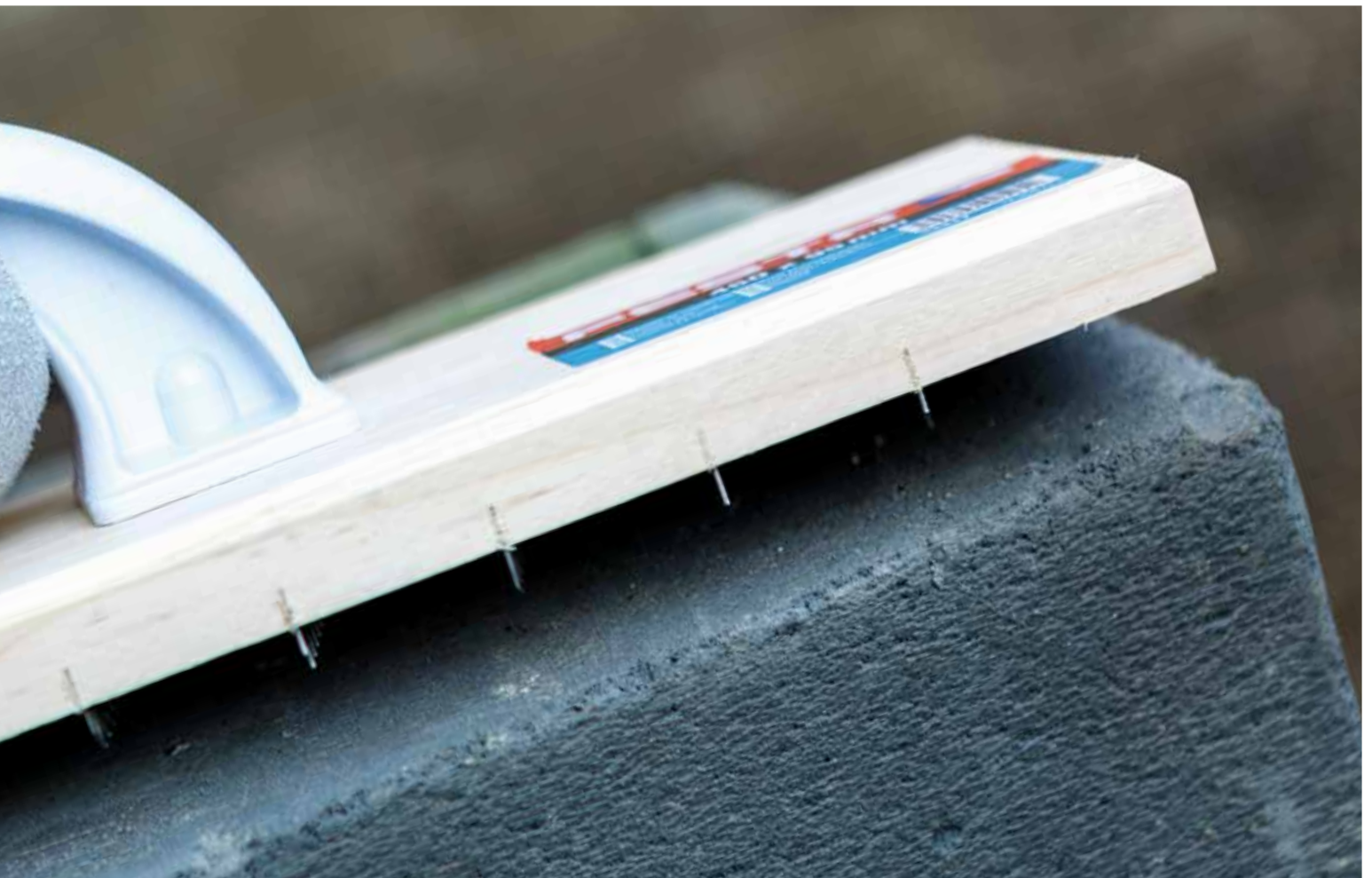

ŠKRABÁK NA STARÉ OMÍTKY



MOQ
2

Č.p.	specifikace
32314	400 x 180 mm



ŠKRABÁK NA STARÉ OMÍTKY



MOQ
2

Č.p.	specifikace
32329	270 x 130 mm



ŠKRABÁK NA STARÉ OMÍTKY S OTVORY



MOQ
2

Č.p.	specifikace
33168	380 x 160 mm



ŠKRABÁK NA STARÉ OMÍTKY

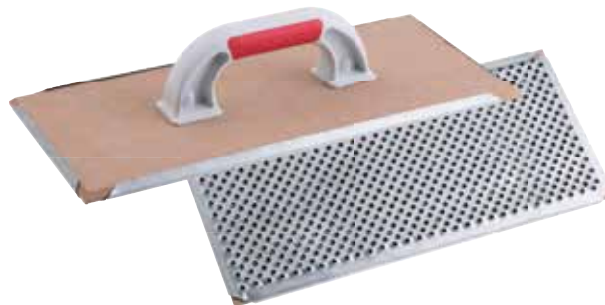

MOQ
2

Č.p.	specifikace
32320	400 x 180 mm



HLADÍTKO BRUSNÉ NA POLYSTYREN



MOQ
2

Č.p.	specifikace	
32418	400 x 180 mm	hr. 16
32421	400 x 180 mm	hr. 16 brusný papír



HLADÍTKO BRUSNÉ NA POLYSTYREN



MOQ
2

Č.p.	specifikace	
32318	400 x 180 mm	
32319	500 x 250 mm	
32321	400 x 180 mm	hr. 16 brusný papír
32322	500 x 250 mm	hr. 16 brusný papír

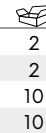

HLADÍTKO BRUSNÉ NA POLYSTYREN PLASTOVÉ



MOQ
2

Č.p.	specifikace	
32324	270 x 130 mm	hr. 16
32323	270 x 130 mm	hr. 16 brusný papír



HLADÍTKO S LEPENÝM BRUSIVEM



MOQ
2

Č.p.	specifikace	
32330	400 x 180 mm	
32331	270 x 130 mm	



ŠKRABÁK NA KAMENNOU VLNU

Zn

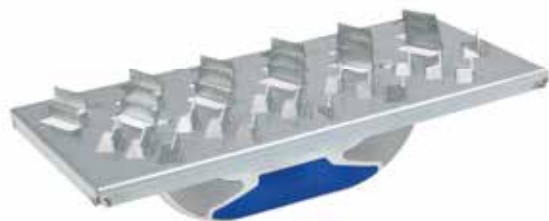
MADE IN
EUMOQ
2

Č.p.	specifikace
32328	285 x 145 mm

10

ŠKRABÁK

FESTA
MADE IN
EUMOQ
2

Č.p.	specifikace
32325	225 x 105 mm

2

ŠKRABÁK MŘÍŽOVÝ

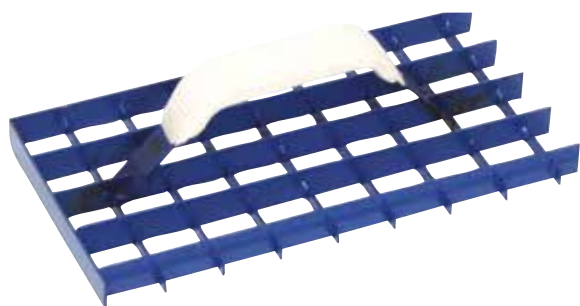
MOQ
2

Č.p.	specifikace
32316	280 x 150 mm

20

ŠKRABÁK MŘÍŽOVÝ OZUBENÝ

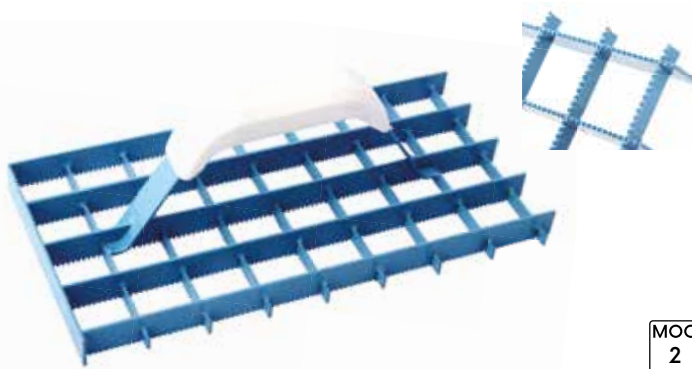
MOQ
2

Č.p.	specifikace
32335	290 x 145 mm

2

ŠKRABÁK

ALU



· 8 břitů

MOQ
2

Č.p.	specifikace
32326	450 x 90 mm

20

ŠKRABÁK PLASTOVÝ



· 6 břitů

MOQ
2

Č.p.	specifikace
32315	270 x 90 mm

30

HLADÍTKO PLASTOVÉ

FESTA
MADE IN
EU

Č.p.	specifikace
34027	400 x 180 mm

20

HLADÍTKO PLAST BEZ POVRCHU

FESTA
MADE IN
EU

Č.p.	specifikace	
30003	270 x 125 mm	28
30004	235 x 115 mm	35
30005	210 x 115 mm	38
30007	210 x 60 mm	44

HLADÍTKO DŘEVĚNÉ

FESTA

· lipové dřevo

Č.p.	specifikace	
34005	400 x 145 mm	40
34007	290 x 145 mm	20

HLADÍTKO DŘEVĚNÉ



· topolové dřevo

Č.p.	specifikace	
34006	400 x 145 mm	40

HLADÍTKO ABS



Č.p.	specifikace	
34041	280 x 140 - 2 mm	10
34051	280 x 140 - 3 mm	10
34053	280 x 140 - 3 mm zubové - e6	10

HLADÍCÍ DESKA NA BETON



Č.p.	specifikace	
15889	980 x 380 mm násada Ø 32 mm	1

STĚRKA S GUMOU



Č.p.	specifikace	
15886	450 mm násada Ø 23 mm	48
15887	600 mm násada Ø 23 mm	48
15888	750 mm násada Ø 23 mm	32

STAHOVACÍ DESKA



Č.p.	specifikace	
15885	100 x 800 mm násada Ø 32 mm	1

HLADÍTKO POLYURETANOVÉ



HLADÍTKO POLYSTYRENOVÉ

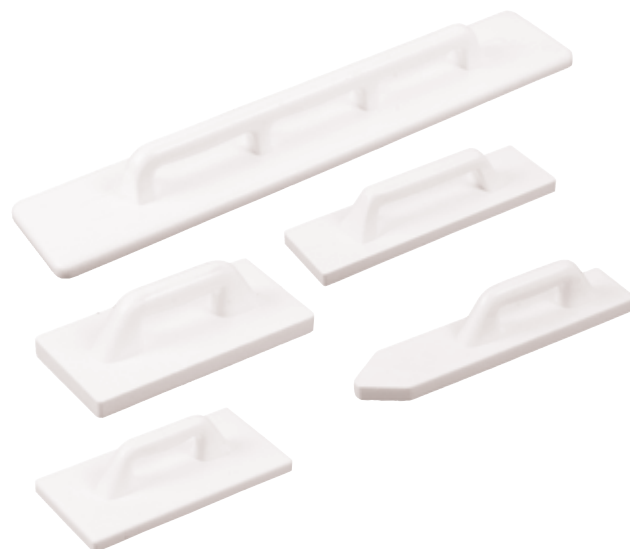

Č.p.	specifikace		Č.p.	specifikace	
34122	120 x 240 mm	50	34154	220 x 420 mm	15
34132	140 x 280 mm	40	34155	240 x 480 mm	15
34142	180 x 320 mm	25	34156	280 x 500 mm	10
34152	200 x 360 mm	20	34157	330 x 330 mm	5
34121	80 x 260 mm zkosené	50	34158	120 x 800 mm	5
34153	100 x 400 mm	30	34159	120 x 1000 mm	5
			34160	120 x 1200 mm	5

Č.p.	specifikace	
34101	80 x 350 mm zkosené	10
34061	130 x 270 mm	10
34111	170 x 320 mm	10
34071	130 x 450 mm	10
34081	140 x 750 mm	10
34091	140 x 900 mm	5

HLADÍTKO POLYURETANOVÉ PUR



HLADÍTKO PRO BRUSNOU MŘÍŽKU

HLADÍTKO PRO BRUSNOU MŘÍŽKU



Č.p.	specifikace	
34115	140 x 280 mm	36
34116	180 x 320 mm	36
34117	200 x 360 mm	24
34118	220 x 420 mm	24
34119	240 x 480 mm	24

Č.p.	specifikace	
34301	230 x 105 mm	1
34304	235 x 80 mm	1

Č.p.	specifikace	
34200	210 x 115 mm	30
34201	240 x 105 mm	50
34202	240 x 80 mm	50

HLADÍTKO NA NÁSADU PRO BRUSNOU MŘÍŽKU

BRUSNÉ MŘÍŽKY SADA

BRUSNÉ MŘÍŽKY SADA



násada 52030

Č.p.	specifikace	
34203	230 x 80 mm aluminium	1
52030	teleskopická násada	12

Č.p.	specifikace	
34271	115 x 290 mm zrn. 120	80
34272	115 x 290 mm zrn. 100	80
34273	115 x 290 mm zrn. 80	80
34274	93 x 290 mm zrn. 120	80
34275	93 x 290 mm zrn. 100	80
34276	93 x 290 mm zrn. 80	80

Č.p.	specifikace	
34280	115 x 290 mm zrn. 120	20
34281	115 x 290 mm zrn. 100	20
34282	115 x 290 mm zrn. 80	20
34283	93 x 290 mm zrn. 120	20
34284	93 x 290 mm zrn. 100	20
34285	93 x 290 mm zrn. 80	20

MATERIÁL POVRCH	BETON		OMÍTKA			LEPIDLO A SPÁROVACÍ HMOTY	FASÁDNÍ LEPIDLO	POUŽITÍ
	HRUBÝ	POTĚROVÝ	JÁDROVÁ	JEMNÁ VNITŘNÍ	JEMNÁ YTONG			
ČERNÁ PLSTĚ (HNĚDÁ, ŠEDÁ)				••••		••		srovnání jemné omítky, na větší zrno omítek
BÍLÁ PLSTĚ				••••	••••	••••		srovnání jemné omítky, na jemnější zrno omítek
MOLITAN JEMNÝ				••••	••••	••••		odstranění volného písku, na jemný štuk (keraštuk), na omytí obkladů po spárování
MOLITAN HRUBÝ				••••	••••	••••		odstranění volného písku, na hrubý štuk
MOLITAN RASTROVANÝ				••••	••••	••••		odstranění volného písku, díky rastrování lépe zachytí hrubé části štuky, na omytí po spárování
MOŘSKÁ HOUBA					•••		••••	smytí spárovací hmoty
HYDRO HOUBA HRUBÁ, JEMNÁ					•		••••	smytí spárovací hmoty
HOUBA				••	••••	••	••••	smytí spárovací hmoty, dočištění jemné omítky, vyhlazení štukových omítek
MIKROPRYŽ							••••	zatlačení spárovací hmoty do spáry
GUMOVÁ PĚNA							••••	zatlačení spárovací hmoty do spáry
MIRELON		••••	•••					zpracování betonu, zapucování jádra
DUREN				••••	••	••••		srovnání jemné omítky, všeobecně k dokončení štukových omítek
DŘEVO	••••	••••	••••					zpracování betonu, zapucování jádra
OCELOVÝ PLECH	••	••••		••		••••	••	gletování betonu, nedostupná místa
POLYSTYREN	•••	••••	•••	••		••		zpracování betonu, zapucování jádra
POLYURETAN	••••	••••	••••					zpracování betonu, zapucování jádra
ABS		••		••••	••••	••••	••••	škrabaná a točená omítka, nanášení lepidla, omítek a štuků, natahování jemné, špalety
NEREZ HLADKÉ				••••	••••	••••	••••	natahování jemné, nanášení lepidel, omítek a štuků, natahování fasádního lepidla
NEREZ ZUBATÉ							••••	natahování lepidla na obklady a dlažbu
BRUSNÉ HLADÍTKO NA POLYSTYREN, PLASTOVÉ			••				••••	broušení polystyrenu, broušení cementového lepidla
BRUSNÉ HLADÍTKO NA POLYSTYREN, PŘEKLIŽKOVÉ			••				••••	broušení fasádního polystyrenu, broušení cementového lepidla

HLADÍTKO PLASTOVÉ S BÍLOU PLSTÍ



NÁHRADNÍ POVRCH - BÍLÁ PLŠŤ



Č.p.	specifikace		Č.p.	specifikace	
34400	280 x 140 x 8 mm	15	34450	220 x 130 x 8 mm	15
34415	250 x 130 x 8 mm	15	34445	220 x 70 x 8 mm	20

Č.p.	specifikace		Č.p.	specifikace	
34241	280 x 140 x 8 mm	1	34460	220 x 130 x 8 mm	1
34223	250 x 130 x 8 mm	1	34475	220 x 70 x 8 mm	1

HLADÍTKO PLASTOVÉ S ČERNOU PLSTÍ



NÁHRADNÍ POVRCH - ČERNÁ PLŠŤ



Č.p.	specifikace		Č.p.	specifikace	
34401	280 x 140 x 10 mm	15	34451	220 x 130 x 10 mm	15
34416	250 x 130 x 10 mm	15	34446	220 x 70 x 10 mm	20

Č.p.	specifikace		Č.p.	specifikace	
34243	280 x 140 x 10 mm	1	34461	220 x 130 x 10 mm	1
34221	250 x 130 x 10 mm	1	34476	220 x 70 x 10 mm	1

HLADÍTKO PLASTOVÉ S HRUBOU HOUBOU



NÁHRADNÍ POVRCH - HRUBÁ HOUBA



Č.p.	specifikace		Č.p.	specifikace	
34441	280 x 140 x 12 mm	15	34473	280 x 140 x 12 mm	1
34440	250 x 130 x 12 mm	15	34472	250 x 130 x 12 mm	1

Č.p.	specifikace		Č.p.	specifikace	
34473	280 x 140 x 12 mm	1	34472	250 x 130 x 12 mm	1

HLADÍTKO PLASTOVÉ S JEMNOU HOUBOU



NÁHRADNÍ POVRCH - JEMNÁ HOUBA



Č.p.	specifikace		Č.p.	specifikace	
34405	280 x 140 x 18 mm	15	34480	280 x 140 x 12 mm	15
34420	250 x 130 x 18 mm	15	34481	250 x 130 x 12 mm	15
34454	220 x 130 x 18 mm	15	34482	220 x 130 x 12 mm	15
34449	220 x 70 x 18 mm	20			

Č.p.	specifikace		Č.p.	specifikace	
34262	280 x 140 x 18 mm	1	34290	280 x 140 x 12 mm	1
34227	250 x 130 x 18 mm	1	34291	250 x 130 x 12 mm	1
34465	220 x 130 x 18 mm	1	34292	220 x 130 x 12 mm	1
34474	220 x 70 x 18 mm	1			

HLADÍTKO PLASTOVÉ S EXTRA JEMNOU HOUBOU



Č.p.	specifikace	
34443	280 x 140 x 12 mm	15
34442	250 x 130 x 12 mm	15

NÁHRADNÍ POVRCH - EXTRA JEMNÁ HOUBA



Č.p.	specifikace	
34471	280 x 140 x 12 mm	1
34470	250 x 130 x 12 mm	1

HLADÍTKO PLASTOVÉ S JEMNÝM MOLITANEM



Č.p.	specifikace		Č.p.	specifikace	
34404	280 x 140 x 30 mm	10	34419	250 x 130 x 20 mm	10
34485	280 x 130 x 20 mm	10	34453	220 x 130 x 20 mm	10
34486	250 x 130 x 30 mm	10	34447	220 x 70 x 20 mm	10

NÁHRADNÍ POVRCH - JEMNÝ MOLITAN



Č.p.	specifikace		Č.p.	specifikace	
34251	280 x 140 x 30 mm	1	34224	250 x 130 x 20 mm	1
34295	280 x 130 x 20 mm	1	34464	220 x 130 x 20 mm	1
34296	250 x 130 x 30 mm	1	34477	220 x 70 x 20 mm	1

HLADÍTKO PLASTOVÉ S RASTROVANÝM MOLITANEM



Č.p.	specifikace	
34409	280 x 140 x 30 mm	10
34425	250 x 130 x 20 mm	10

NÁHRADNÍ POVRCH - RASTROVANÝ MOLITAN



Č.p.	specifikace	
34253	280 x 140 x 30 mm	1
34225	250 x 130 x 20 mm	1

HLADÍTKO PLASTOVÉ S HRUBÝM MOLITANEM



Č.p.	specifikace	
34410	280 x 140 x 30 mm	10
34426	250 x 130 x 20 mm	10

NÁHRADNÍ POVRCH - HRUBÝ MOLITAN

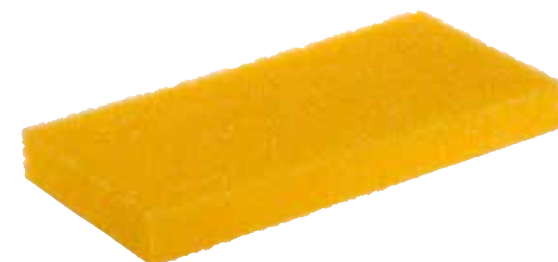

Č.p.	specifikace	
34261	280 x 140 x 30 mm	1
34226	250 x 130 x 20 mm	1

HLADÍTKO PLASTOVÉ S MOŘSKOU HOUBOU



Č.p.	specifikace	
34406	280 x 140 x 30 mm	10
34421	250 x 130 x 30 mm	10
34455	220 x 130 x 30 mm	10

NÁHRADNÍ POVRCH - MOŘSKÁ HOUBA



Č.p.	specifikace	
34265	280 x 140 x 30 mm	1
34228	250 x 130 x 30 mm	1
34466	220 x 130 x 30 mm	1

HLADÍTKO PLASTOVÉ S MOŘSKOU HOUBOU, RASTROVANOU



Č.p.	specifikace	
34413	280 x 140 x 30 mm	10
34428	250 x 130 x 30 mm	10

NÁHRADNÍ POVRCH - MOŘSKÁ HOUBA RASTROVANÁ



Č.p.	specifikace	
34264	280 x 140 x 30 mm	1
34233	250 x 130 x 30 mm	1

HLADÍTKO PLASTOVÉ S HYDRO HOUBOU HRUBOU

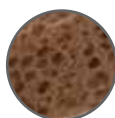

Č.p.	specifikace	
34412	280 x 140 x 30 mm	10
34424	250 x 130 x 30 mm	10
34458	220 x 130 x 30 mm	10

NÁHRADNÍ POVRCH - HYDRO HOUBA HRUBÁ

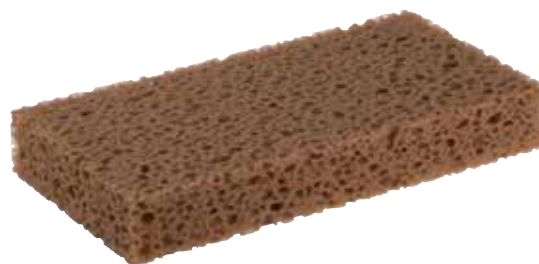

Č.p.	specifikace	
34238	280 x 140 x 30 mm	1
34236	250 x 130 x 30 mm	1
34469	220 x 130 x 30 mm	1

HLADÍTKO PLASTOVÉ S HYDRO HOUBOU HRUBOU, RASTROVANOU



Č.p.	specifikace	
34490	280 x 140 x 30 mm	10
34491	250 x 130 x 30 mm	10

NÁHRADNÍ POVRCH - HYDRO HOUBA HRUBÁ, RASTROVANÁ



Č.p.	specifikace	
34298	280 x 140 x 30 mm	1
34299	250 x 130 x 30 mm	1

HLADÍTKO PLASTOVÉ S HYDRO HOUBOU JEMNOU

FESTA®

Č.p.	specifikace	
34411	280 x 140 x 30 mm	10
34423	250 x 130 x 30 mm	10
34457	220 x 130 x 30 mm	10

NÁHRADNÍ POVRCH - HYDRO HOUBA JEMNÁ



Č.p.	specifikace	
34237	280 x 140 x 30 mm	1
34235	250 x 130 x 30 mm	1
34468	220 x 130 x 30 mm	1

HLADÍTKO PLASTOVÉ S GUMOVOU PĚNOU

FESTA®

Č.p.	specifikace	
34402	280 x 140 x 10 mm	15
34417	250 x 130 x 10 mm	15
34452	220 x 130 x 10 mm	15

NÁHRADNÍ POVRCH - GUMOVÁ PĚNA



Č.p.	specifikace	
34231	280 x 140 x 10 mm	1
34222	250 x 130 x 10 mm	1
34462	220 x 130 x 10 mm	1

HLADÍTKO PLASTOVÉ S MIKROPŘYŽÍ

FESTA®

Č.p.	specifikace	
34403	280 x 140 x 8 mm	15
34418	250 x 130 x 8 mm	15
34496	220 x 130 x 8 mm	15

NÁHRADNÍ POVRCH - MIKROPŘYŽ



Č.p.	specifikace	
34232	280 x 140 x 8 mm	1
34230	250 x 130 x 8 mm	1
34463	220 x 130 x 8 mm	1

HLADÍTKO PLASTOVÉ DUREN

FESTA®

Č.p.	specifikace	
34407	280 x 140 x 20 mm	10
34422	250 x 130 x 20 mm	10
34456	220 x 130 x 20 mm	10
34448	220 x 70 x 20 mm	10

NÁHRADNÍ POVRCH - DUREN



Č.p.	specifikace	
34266	280 x 140 x 20 mm	1
34267	250 x 130 x 20 mm	1
34467	220 x 130 x 20 mm	1
34478	220 x 70 x 20 mm	1

HLADÍTKO PLASTOVÉ RUVEN

FESTA®



Č.p.	specifikace	
34414	280 x 140 x 20 mm	10
34429	250 x 130 x 20 mm	10
34459	220 x 130 x 20 mm	10
34479	220 x 70 x 20 mm	10

NÁHRADNÍ POVRCH - RUVEN



Č.p.	specifikace	
34167	280 x 140 x 20 mm	1
34168	250 x 130 x 20 mm	1

HLADÍTKO SPÁROVACÍ

FESTA®



Č.p.	specifikace	
34033	240 x 95 mm	5

HLADÍTKO PLAST BEZ POVRCHU

FESTA®



Č.p.	specifikace	
30003	270 x 125 mm	28
30004	235 x 115 mm	35
30005	210 x 115 mm	38
30007	210 x 60 mm	44

HLADÍTKO KOUTOVÉ S HOUBOU 90°

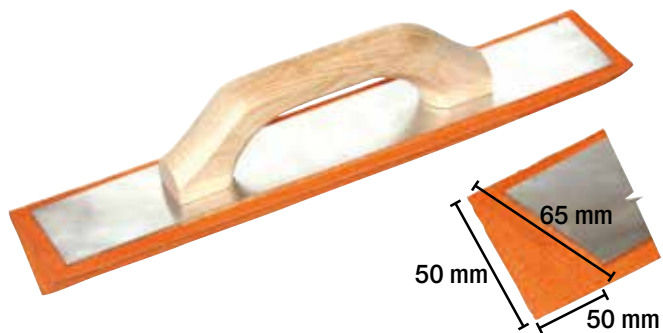

Č.p.	specifikace	
34500	350 mm	6

NABĚRAČKA ZEDNICKÁ S RUČKOU NEREZ

FESTA

INOX



Č.p.	specifikace	
32285	Ø 180 mm	1

NABĚRAČKA ZEDNICKÁ S RUČKOU POZINK

FESTA

Zn



Č.p.	specifikace	
32265	Ø 180 mm	10

NABĚRAČKA ZEDNICKÁ S RUČKOU

FESTA



Č.p.	specifikace	
32273	Ø 160 mm	10
32285	Ø 180 mm	10
32293	Ø 215 mm	10

NABĚRAČKA ZEDNICKÁ PLASTOVÁ



Č.p.	specifikace	
32270	Ø 160 mm	1

NABĚRAČKA ZEDNICKÁ OCEL



Č.p.	specifikace	
32302	Ø 180 mm	1
32313	Ø 215 mm	1
32301	Ø 235 mm	1

· vhodná násada 61215

NABĚRAČKA ZEDNICKÁ OCEL S RUČKOU PRO LOPATOVOU NÁSADU

· vhodná násada 61200, 61201



Č.p.	specifikace	
32268	Ø 215 mm	1
32269	Ø 235 mm	1
32296	Ø 215 mm	1

NABĚRAČKA ZEDNICKÁ OCEL S NÁSADOU



MOQ
3

Č.p.	specifikace	
32295	Ø 180 mm délka násady 160 cm	3
32297	Ø 215 mm délka násady 160 cm	3
32298	Ø 235 mm délka násady 160 cm	3

HRÁBLŮ NA BETON



Č.p.	specifikace	
60100	hráblo na beton 295 x 150 mm	24
61169	hráblo s násadou 160 cm	3
61218	násada 160 cm	5

ELEKTRICKÉ MÍCHADLO STAVEBNÍCH SMĚSÍ DVOUMETLOVÉ

FESTA®

NEW

Zn

CE



Příkon	1800 W
Napětí/frekvence	230 V / 50 Hz
Rychlostní stupně	2
1. stupeň (volnoběžné otáčky)	0 - 450 ot./min.
2. stupeň (volnoběžné otáčky)	0 - 790 ot./min.
Ochrana proti přetížení	Ano
Průměr míchacího koše	100 mm
Délka míchací metly	570 mm
Hmotnost	5,6 kg



Č.p. specifikace

35311	míchadlo	1
35318	náhradní uhlík	1
35319	míchadla náhradní - pár (L+P)	1

ELEKTRICKÉ MÍCHADLO STAVEBNÍCH SMĚSÍ 850 W

M14

Zn

CE



Příkon	850 W
Napětí/frekvence	230 V / 50 Hz
Rychlostní stupně	1
1. stupeň (volnoběžné otáčky)	0 - 500 ot./min.
2. stupeň (volnoběžné otáčky)	-
Ochrana proti přetížení	Ano
Závit míchací metly	M 14
Průměr míchacího koše	120 mm
Délka míchací metly	600 mm
Hmotnost	3,7 kg



Č.p. specifikace

35300		1
35316	náhradní uhlík	1

ELEKTRICKÉ MÍCHADLO STAVEBNÍCH SMĚSÍ 1600 W

M14

Zn

CE



Příkon	1600 W
Napětí/frekvence	230 V / 50 Hz
Rychlostní stupně	2
1. stupeň (volnoběžné otáčky)	0 - 480 ot./min.
2. stupeň (volnoběžné otáčky)	0 - 800 ot./min.
Ochrana proti přetížení	Ano
Závit míchací metly	M 14
Průměr míchacího koše	140 mm
Délka míchací metly	600 mm
Hmotnost	4,7 kg



Č.p. specifikace

35310		1
35317	náhradní uhlík	1

MÍCHADLO S KRUHEM PRAVOTOČIVÉ

Zn

M14



Spirálová metla se třemi rameny a kroužkem pravotočivá – pro těžké materiály s vysokou viskozitou. Malty, betony, cementové a vápenné omítky, spojovací hmoty, mazaniny, epoxidové pryskyřice, živичné vrstvy- Míchací účinek odspodu nahoru – metla se jako šroub vtahuje do materiálu.



Č.p.	specifikace	
35059	M14 Ø 90 x 550 mm	24
35085	M14 Ø 120 x 600 mm	12
35086	M14 Ø 140 x 600 mm	12
35087	M14 Ø 160 x 600 mm	12

MÍCHADLO S KRUHEM LEVOTOČIVÉ

Zn

M14



Spirálová metla se třemi rameny a kroužkem levotočivá – pro řídké tekuté směsi ve velkém množství. Mícháný materiál je tlačěn dolů. Řídký tekutý materiál nestříká z nádoby, usazené pigmenty barev se dostávají vzhůru a ideálně se promíchají.



Č.p.	specifikace	
35091	M14 Ø 120 x 600 mm	12
35092	M14 Ø 140 x 600 mm	12
35093	M14 Ø 160 x 600 mm	12

MÍCHADLO S KRUHEM



Zn



Spirálová metla se dvěma rameny – pro důkladné rozmíchání lepidel na obklady, spárovacích hmot, lepicích malt, hotových omítek, mazaniny, stěrkovacích hmot, vyrovnávacích hmot.

Č.p.	specifikace	
35038	Ø 80 x 500 mm	24
35058	Ø 100 x 500 mm	24
35023	Ø 120 x 500 mm	24

MÍCHADLO S KRUHEM

SDS+

Zn



Spirálová metla se dvěma rameny – pro důkladné rozmíchání lepidel na obklady, spárovacích hmot, lepicích malt, hotových omítek, mazaniny, stěrkovacích hmot, vyrovnávacích hmot.

Č.p.	specifikace	
35094	Ø 80 x 500 mm	24
35095	Ø 100 x 500 mm	24
35096	Ø 120 x 500 mm	24

MÍCHADLO S KRUHEM, PRODLOUŽENÁ SPIRÁLA



Zn



Spirálová metla se dvěma rameny – pro důkladné rozmíchání lepidel na obklady, spárovaných hmot, lepicích malt, hotových omítek, mazaniny, stěrkovacích hmot, vyrovnávacích hmot.

Č.p.	specifikace	
35013	Ø 80 x 500 mm	24
35006	Ø 100 x 500 mm	24
35007	Ø 120 x 500 mm	24

MÍCHADLO S KRUHEM, PRODLOUŽENÁ SPIRÁLA

SDS+

Zn



Spirálová metla se dvěma rameny – pro důkladné rozmíchání lepidel na obklady, spárovaných hmot, lepicích malt, hotových omítek, mazaniny, stěrkovacích hmot, vyrovnávacích hmot.

Č.p.	specifikace	
35012	Ø 100 x 500 mm	24

MÍCHADLO SPIRÁLA DRÁT



Zn



Spirálová metla se dvěma rameny – pro důkladné rozmíchání lepidel na obklady, spárovaných hmot, lepicích malt, hotových omítek, mazaniny, stěrkovacích hmot, vyrovnávacích hmot.

Č.p.	specifikace	
35069	Ø 60 x 500 mm	50
35078	Ø 80 x 500 mm	24
35081	Ø 100 x 500 mm	24

MÍCHADLO SPIRÁLA DRÁT

SDS+

Zn



Spirálová metla se dvěma rameny – pro důkladné rozmíchání lepidel na obklady, spárovaných hmot, lepicích malt, hotových omítek, mazaniny, stěrkovacích hmot, vyrovnávacích hmot.

Č.p.	specifikace	
35070	Ø 60 x 500 mm	50
35079	Ø 80 x 500 mm	24
35082	Ø 100 x 500 mm	24

MÍCHADLO BEZ KRUHU



Zn



Spirálová metla se dvěma rameny – pro důkladné rozmíchání lepidel na obklady, spárovaných hmot, lepicích malt, hotových omítek, mazaniny, stěrkových hmot, vyrovnávacích hmot.

Č.p.	specifikace	
35048	Ø 70 x 500 mm	24
35068	Ø 90 x 500 mm	24

MÍCHADLO BEZ KRUHU



Zn



Spirálová metla – pro vysoce viskózní a lepivé materiály, jako jsou stavební lepidla a tmely, omítky, podlahové stěrky a pod. Materiál proudí ode dna k hladině.

Č.p.	specifikace	
35021	Ø 100 x 500 mm	24

MÍCHADLO KALICH



Zn



Klecová metla – pro materiály, kde je zavzdušnění směsi nežádoucí. Pro řídké vyrovnávací hmoty, stěrkové hmoty, těsnicí látky, lepidla.

Č.p.	specifikace	
35015	Ø 100 x 500 mm	20

MÍCHADLO VRTULE



Zn



Vrtulová metla – pro tekuté materiály, barvy, laky, nástěnné a disperzní klišy na lepení tapet, lepidla na dlaždice.

Č.p.	specifikace	
35011	Ø 80 x 500 mm	50

MÍCHADLO S KRUHEM



Zn



Oblouková metla s kruhem – pro důkladné rozmíchání nástěnných barev, disperzních barev, kličů, laků.

Č.p.	specifikace	
35125	Ø 60 x 400 mm	40
35126	Ø 80 x 400 mm	40
35127	Ø 100 x 600 mm	20

MÍCHADLO S KRUHEM LAKOVANÉ



Oblouková metla s kruhem – pro důkladné rozmíchání nástěnných barev, disperzních barev, kličů, laků.

Č.p.	specifikace	
35103	Ø 60 x 400 mm	40
35113	Ø 80 x 400 mm	40
35123	Ø 100 x 600 mm	20

KABEL PRODLUŽOVACÍ S NAVIJÁKEM



KABEL PRODLUŽOVACÍ



- Prodlužovací přívod s navijákem 25 m - IP20
- H05VV - F 3G 1,5mm², - Vybavený tepelnou pojistkou
- Výkon v navinutém stavu : 1000 W max.
- Výkon v rozvinutém stavu : 3000 W max.
- 4 uzemněné zásuvky s dětskou pojistkou



Č.p.	specifikace	
37760	4 zásuvky délka 25 m, IP 20, 1,5 mm ²	2
37761	4 zásuvky délka 50 m, IP 20, 1,5 mm ²	2

Č.p.	specifikace	
37730	max. 3680 W délka 10 m, 1,5 mm ²	8
37731	max. 3680 W délka 20 m, 1,5 mm ²	4

TOPIDLO ELEKTRICKÉ



napětí	230V ~50Hz
výkon	3300W
proudové zatížení	14,5A
nastavení výkonu	30/1650/3300W
teplotní rozsah	5-40°C
krytí	IP24
rozměry	27 x 25,5 x 40cm
hmotnost	4,8 kg

- rychlé a efektivní vytápění sklepů, dílen, obchodů, párty stanů, skleníků atd.
- nespotebovává kyslík
- bezpečný provoz, plynulá regulace výkonu, prostorový termostat, ventilátor
- topné těleso z nerezavějící oceli
- možnost letního využití pro ventilaci bez ohřevu
- nízká hladina hluku
- kvalitní zpracování, materiály, robustní ocelová konstrukce, snadná a bezpečná manipulace, dlouhá životnost



1

Č.p. specifikace
35833 3,3 kW

TOPIDLO PLYNOVÉ



plyn	G30-I3B/P
tlak plynu	0,7bar
jmenovité napětí	230V 50Hz
výkon motoru	25W
maximální spotřeba plynu	1,11 Kg/h
maximální tepelný výkon	15KW
maximální objem horkého vzduchu	300m ³ /h

- rychlé a efektivní vytápění při stavebních pracích, v dílnách atd.
- spotřebovává kyslík!
- přímý ohřev vzduchu s nucenou cirkulací – rychlý nástup tepla
- bezpečný provoz, plynulá regulace výkonu
- termostat a bezpečnostní ventil proti přehřátí a úniku plynu
- včetně příslušenství – regulátor a přírodní plynová hadice
- kvalitní zpracování, materiály, robustní ocelová konstrukce, snadná a bezpečná manipulace, dlouhá životnost



1

Č.p. specifikace
35845 15 kW

TOPIDLO PLYNOVÉ



plyn	g30-i3b/p
tlak plynu	1,5bar
jmenovité napětí	230v 50hz
výkon motoru	70w
maximální spotřeba plynu	2,2kg/h
maximální tepelný výkon	30kw
maximální objem horkého vzduchu	750m ³ /h

- rychlé a efektivní vytápění při stavebních pracích, v dílnách atd.
- spotřebovává kyslík!
- přímý ohřev vzduchu s nucenou cirkulací – rychlý nástup tepla
- bezpečný provoz, plynulá regulace výkonu
- termostat a bezpečnostní ventil proti přehřátí a úniku plynu
- včetně příslušenství – regulátor a přírodní plynová hadice
- kvalitní zpracování, materiály, robustní ocelová konstrukce, snadná a bezpečná manipulace, dlouhá životnost



1

Č.p. specifikace
35850 30 kW



Stavební míchačky pro nejnáročnější profesionální použití

Zubový věnec z litiny s patentovaným uchycením

Nastavitelná vůle zubů

Vysoce kvalitní povrchová úprava

Dvojitě uložené ložiskové na dně bubny

Patentovaná ochranná izolace, kvalitativní jistění dle DIN EN ISO 9001

Speciálně vyvinutý tvar bubny

Ochrana proti střikající vodě IP 45

Dodávány v provedení na 230V i 400V

PROFESIONÁLNÍ STAVEBNÍ MÍCHAČKY

Lescha

MÍCHAČKA STAVEBNÍ



Lescha



Č.p.	specifikace	
35500	Star 150 - 125 l, 230 V nožní brzda	1

MÍCHAČKA STAVEBNÍ



Lescha



Č.p.	specifikace	
35502	EUROMIX 125 l, 230 V	1
35503	EUROMIX 125 l, 400 V	1

MÍCHAČKA STAVEBNÍ



Lescha



Č.p.	specifikace	
35501	BX 135 - 125 l, 230 V	1

MÍCHAČKA STAVEBNÍ



Lescha



Č.p.	specifikace	
35504	ABM 135 l, 230 V nožní brzda	1

MÍCHAČKA STAVEBNÍ



Lescha



Č.p.	specifikace	
35505	SM 145 S - 140 l, 230 V	1
35506	SM 145 S - 140 l, 400 V	1
35507	SM 145 S - 140 l, 230 V nožní brzda	1
35508	SM 145 S - 140 l, 400 V nožní brzda	1

MÍCHAČKA STAVEBNÍ



Lescha



Č.p.	specifikace	
35510	SM 165 S - 160 l, 230 V nožní brzda	1
35511	SM 165 S - 160 l, 400 V nožní brzda	1
35512	SM 165 S - 160 l, G benzínová	1

MÍCHAČKA STAVEBNÍ



Lescha



Č.p.	specifikace	
35514	SM 185 S - 180 l, 230 V nožní brzda	1
35515	SM 185 S - 180 l, 400 V nožní brzda	1

MÍCHAČKA STAVEBNÍ



Lescha



Č.p.	specifikace	
35516	S 180 HR - 180 l, 230 V nožní brzda	1
35517	S 180 HR - 180 l, 400 V nožní brzda	1

MÍCHAČKA STAVEBNÍ



Lescha



Č.p.	specifikace		
35524	LB 354 230 V, 1,5 kW		1
35525	LB 354 400 V, 1,5 kW		1
35527	LB 354 Honda G200		1
35532	LB 404 230 V, 1,5 kW		1
35533	LB 404 400 V, 1,5 kW		1
35539	LB 484 Robin EH17B		1
35540	LB 484 Honda GX160LX		1
35542	AT 480 400 V, 1,2 kW		1

MÍCHAČKA STAVEBNÍ



Lescha



Č.p.	specifikace		
35552	LHB 1000 400 V		1
35553	LHB 1000 HATZ Diesel		1
35555	LHB 1200 400 V		1

MÍCHAČKA STAVEBNÍ



Lescha



Č.p.	specifikace	
35518	S 230 HR - 230 l, 230 V nožní brzda	1
35519	S 230 HR - 230 l, 400 V nožní brzda	1



MÍCHAČKA STAVEBNÍ



130 L

specifikace	
objem bubnu	130 l
otáčky bubnu	26±Min ⁻¹
příkon	700 W
napětí	230 V / 50 Hz
stupeň krytí	IP44
materiál věnce	litinový
rozměry	délka 1170 mm
	šířka 650 mm
	výška 1280 mm
váha	53 kg

165 L

specifikace	
objem bubnu	165 l
otáčky bubnu	23±Min ⁻¹
příkon	900 W
napětí	230 V / 50 Hz
stupeň krytí	IP44
materiál věnce	litinový
rozměry	délka 1295 mm
	šířka 735 mm
	výška 1440 mm
váha	70 kg

č.p.	specifikace				
37500	MIX 130Zk	230 V	rozložená		1
37501	MIX 130Z	230 V	složená		1
37505	MK 165Bk	230 V	rozložená		1
37506	MK 165B	230 V	složená		1

MÍCHAČKA STAVEBNÍ



· speciálně vyrobené lopatky, tloušťka 4 mm



· kvalitní patní ložisko s krytem



· vypínač s bezpečnostní krytkou



· plastový kryt pohonu, litinový věnec

125 L

specifikace	
objem bubnu	125 l
otáčky bubnu	26±Min ⁻¹
příkon	550 W
napětí	230 V / 50 Hz
stupeň krytí	IP44
materiál věnce	litinový
rozměry	délka 1102 mm šířka 690 mm výška 1310 mm
váha	52,5 kg

Č.p.	specifikace		
37509	126 l, 230 V	složená	1
37510	126 l, 230 V	rozložená	1

142 L

specifikace	
objem bubnu	142 l
otáčky bubnu	26±Min ⁻¹
příkon	650 W
napětí	230 V / 50 Hz
stupeň krytí	IP44
materiál věnce	litinový
rozměry	délka 1164 mm šířka 690 mm výška 1293 mm
váha	54 kg

Č.p.	specifikace		
37511	142 l, 230 V	rozložená	1
37512	142 l, 230 V	složená	1

162 L

specifikace	
objem bubnu	162 l
otáčky bubnu	26±Min ⁻¹
příkon	650 W
napětí	230 V / 50 Hz
stupeň krytí	IP44
materiál věnce	litinový
rozměry	délka 1180 mm šířka 710 mm výška 1310 mm
váha	56 kg

Č.p.	specifikace		
37515	162 l, 230 V	rozložená	1
37516	162 l, 230 V	složená	1

180 L

specifikace	
objem bubnu	180 l
otáčky bubnu	26±Min ⁻¹
příkon	850 W
napětí	230 V / 50 Hz
stupeň krytí	IP44
materiál věnce	litinový
rozměry	délka 1164 mm šířka 690 mm výška 1368 mm
váha	58 kg

Č.p.	specifikace		
37517	180 l, 230 V	rozložená	1
37518	180 l, 230 V	složená	1

SHOZ STAVEBNÍ SUTI

Lescha
MADE IN
EU



Č.p.	specifikace	
35603	shoz základní průměr 50 cm, délka 110 cm PE (HDPE)	1
35604	násepka shozu stavební suti PE (HDPE)	1
35605	nosný rám pro násepku shozu stavební suti	1



KOLEČKO STAVEBNÍ



Č.p.	specifikace	
37530	60 l, Ø 38 cm samonosné kolečko	1
37532	60 l, Ø 40 cm nafukovací	1

KOLEČKO STAVEBNÍ POZINK



Zn



Č.p.	specifikace	
37527	80 l, Ø 40 cm nafukovací	1
37533	80 l, Ø 38 cm samonosné kolečko	1

KORBA ČERNÁ



Č.p.	specifikace	
37539	60 l	1

KORBA POZINK



Zn



Č.p.	specifikace	
37541	80 l	1

NÁHRADNÍ KOLA



Č.p.	specifikace		
48729	typ AA 400	nafukovací	1
48730	typ AA 380	samonosné	1
48731	typ AA 380	samonosné	1

DRŽÁK DLAŽBY STAVITELNÝ



Č.p.	specifikace	
36310	max. 20kg	5

NOSIČ OBRUBNÍKŮ



Č.p.	specifikace	
60116	PRO 041	1

PALICE PRO SROVNÁNÍ ŘAD



specifikace	60121	60123
výška	200 mm	200 mm
šířka	70 kg	70 kg
délka	870 mm	450 mm
hmotnost	2,5 kg	2,2 kg

Č.p.	specifikace	
60121	870 mm	1
60123	450 mm	1

JAPONKA STAVEBNÍ TŘÍKOLÁ



Č.p.	specifikace	
37564	60 l	1

NOSIČ OBRUBNÍKŮ



Č.p.	specifikace	
60115	PRO 040	1

NOSIČ OBRUBNÍKŮ



Č.p.	specifikace	
60117	PRO 042	1
60118	PRO 043	1

PODLOŽKA VYROVNÁVACÍ POD DLAŽBU



Č.p.	specifikace	
37166	D10 základní	25

RUDL



Č.p.	specifikace	nosnost	
48719	kolo 260 mm bantam	250 kg	1

KOZA NA ŘEZÁNÍ DŘEVA

NEW

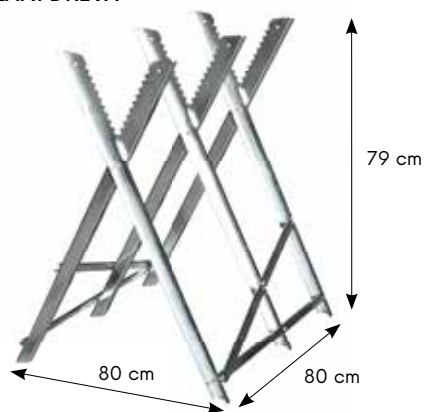

Č.p. / No.	rozměry	
37570	max. 150 kg	1

KOZA SKLÁDACÍ

2x



· max. nosnost 125 kg



Č.p.	specifikace	
37549	pár	1

KOZA PLASTOVÁ, SKLÁDACÍ

2x



· max. nosnost 150 kg (300 kg v páru)

Č.p.	specifikace	
37560	pár	1

PODPĚRA STAVEBNÍ

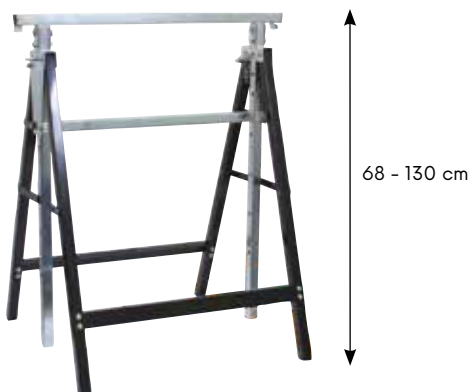

Č.p.	specifikace	
36300	68 - 130 cm, max. 125 kg	1

KOZA LEŠENÁŘSKÁ



Č.p.	specifikace	
37545	140 cm, výška 98 - 165 cm	1
37546	120 cm, výška 98 - 165 cm	1

PROFESIONÁLNÍ ŘEZAČKY OBKLADŮ

- řezačky dlažby pro nejnáročnější profesionální použití
- pojezd je řešen 9 zapouzdřenými kuličkovými ložisky skf,
- 4 jsou stavitelné a vymezují vůli pojezdu
- odpružené stoly
- lze kompletovat i pro práci levou rukou
- zajištěny veškeré náhradní díly a servis
- řezná kolečka z chrom wolframové oceli



ŘEZAČKA DLAŽBY SUPER PRO "EVO"

NEW

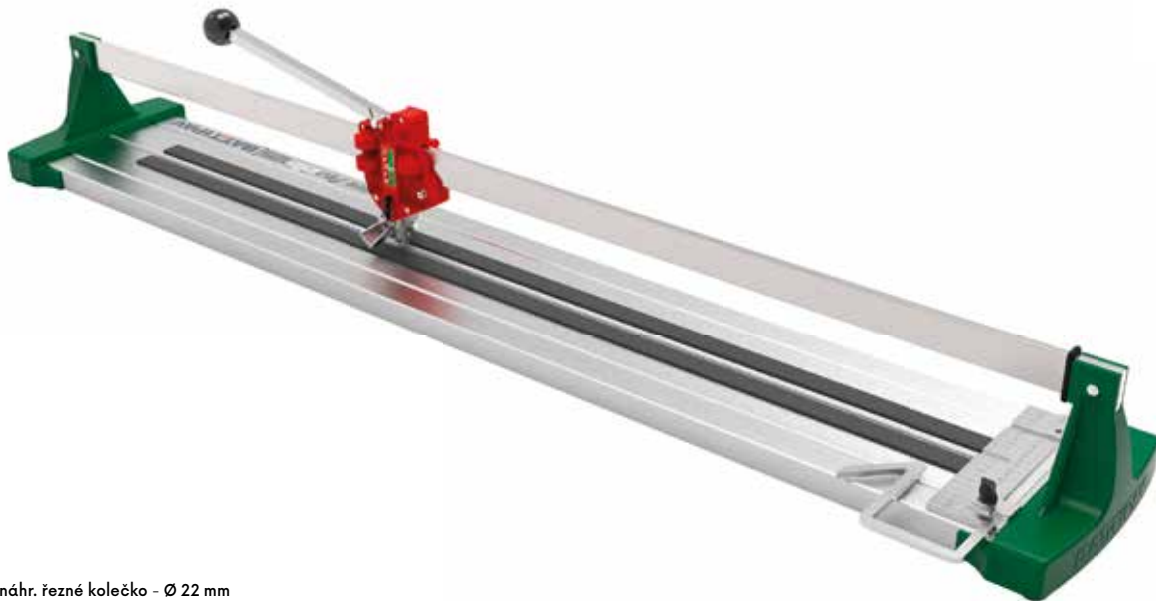

SUPER PRO



- 36195 náhr. řezné kolečko - Ø 22 mm

Č.p.	specifikace
36191	1250 mm



ŘEZAČKA DLAŽBY SUPER PRO



- 36195 náhr. řezné kolečko - Ø 22 mm

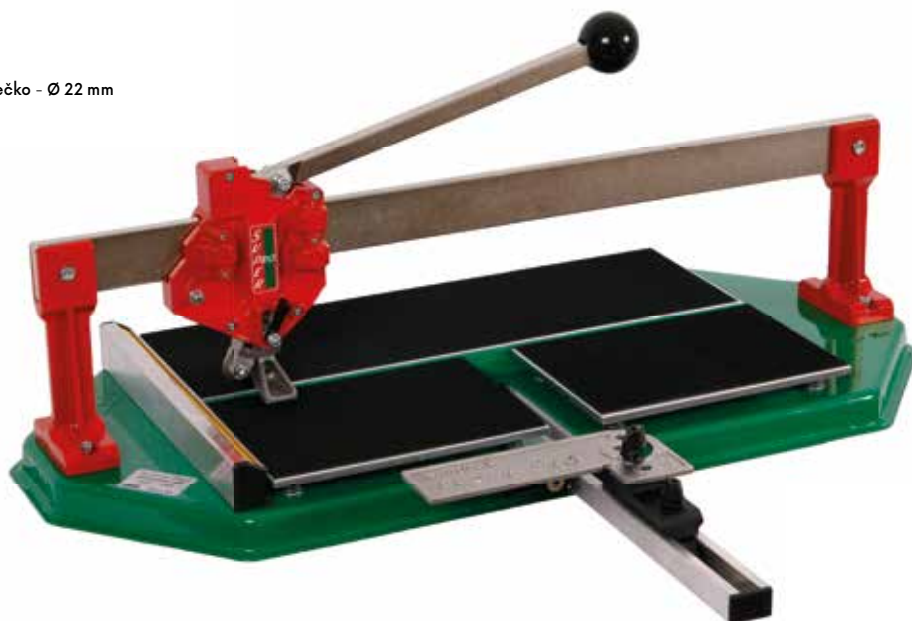

SUPER PRO



Č.p.	specifikace
36145	SUPER PRO 450 mm
36160	SUPER PRO 600 mm
36175	SUPER PRO 750 mm
36190	SUPER PRO 900 mm



ŘEZAČKA DLAŽBY BASIC PLUS + KUFR



PRODEJNÍ STOJAN SUPER PRO



· ilustrační foto

· 36261 náhr. řezné kolečko - Ø 15 mm

Č.p.	specifikace
36240	400 mm



Č.p.	specifikace	
36200	prodejní stojan	1
36199	prodejní stojan osazený 36160, 36175, 36190	1

ŘEZAČKA DLAŽBY „X“



FESTA®

· 36138 náhr. řezné kolečko - Ø 22 mm

Č.p.	specifikace	
36085	600 mm	1
36087	900 mm	1
36086	1300 mm	1



ŘEZAČKA DLAŽBY



FESTA®

· 36195 náhr. řezné kolečko - Ø 22 mm

Č.p.	specifikace	
36080	600 mm	1
36081	750 mm	1
36082	900 mm	1



Č.p.	specifikace	
36076	750 mm složená	1
36077	900 mm složená	1

ŘEZAČKA DLAŽBY S VYKRUŽOVÁKEM

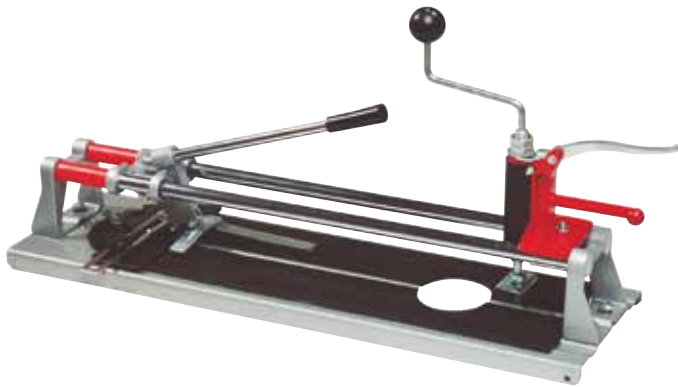

· 36128 náhr. řezné kolečko - Ø 16 mm

Č.p.	specifikace
36014	480 mm



4

ŘEZAČKA DLAŽBY



· 36126 náhr. řezné kolečko - Ø 15 mm

Č.p.	specifikace
36024	300 mm
36034	400 mm
36035	600 mm



10

10

4

ŘEZAČKA DLAŽBY



· 36136 náhr. řezné kolečko - Ø 22 mm

Č.p.	specifikace
36036	480 mm



1

ŘEZAČKA DLAŽBY RUČNÍ



· 36136 náhr. řezné kolečko - Ø 22,2 mm

Č.p.	specifikace
36046	22 mm



1

NÁHRADNÍ KOLEČKO DO ŘEZAČEK DLAŽBY

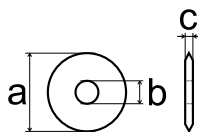

Č.p.	specifikace
36126	a= Ø 15 mm, b= Ø 6 mm, c= 1,5 mm
36128	a= Ø 16 mm, b= Ø 6 mm, c= 3 mm
36130	a= Ø 20 mm, b= Ø 6 mm, c= 5 mm
36136	a= Ø 22 mm, b= Ø 6 mm, c= 2 mm

1

1

1

1

PILKA PŘÍMOČARÁ NA OBKLADY A KERAMIKU



Č.p.	specifikace
24055	Karbid - BOSCH, MAKITA



1

KLEŠTĚ NA OBKLADY

FESTA

KLEŠTĚ NA OBKLADY

NEW



Č.p.	specifikace
36057	200 mm

6



Č.p.	specifikace
36056	200 mm

10

KLEŠTĚ ŠTÍPACÍ NA KERAMIKU



Č.p.	specifikace
36059	

1

KLEŠTĚ (PAPOUŠEK)



Č.p.	specifikace
36058	200 mm

6

HOUBA VYMÝVACÍ 160 X 110 X 60 MM



37028



37029

Č.p.	specifikace	
37028	hydro houba	1
37029	mořská houba	1

HOUBA VYMÝVACÍ 200 X 100 X 100 MM



37025



37026

Č.p.	specifikace	
37025	jemný molitan	1
37026	mořská houba	1

VANIČKA VYMÝVACÍ



Č.p.	specifikace	
37117	sada	1
90070	nádoba 25 l	1

VANIČKA VYMÝVACÍ - PŘÍSLUŠENSTVÍ



Č.p.	specifikace	
90072	mřížka	1
90071	válečky kovové	1

ČISTIČ SPÁR



4 mm



Č.p. specifikace

37012

1

SADA NA APLIKACI A ODSTRANĚNÍ SILIKONU

3x



Č.p. specifikace

16042

12

APLIKÁTOR SILIKONU

FESTA



Č.p. specifikace

16056

145 mm

50

STĚRKA



na spárování oken

Č.p. specifikace

37055

na spárování oken



1

ČISTIČ SPÁR



37006

37007



Č.p. specifikace

37006 30 mm



20

37007 50 mm

20

37008 náhradní ostří 30 mm

50

37009 náhradní ostří 50 mm

50

SADA STĚREK

4x



Č.p. specifikace

37053

48

STĚRKA



Č.p. specifikace

37054



1

STĚRKA DŘEVĚNÁ S GUMOU

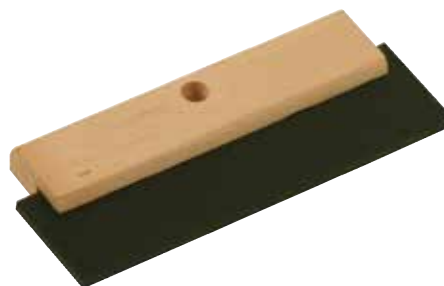

Č.p. specifikace

37011 180 mm



12

37021 280 mm

12

MAGNETY POD OBKLADY

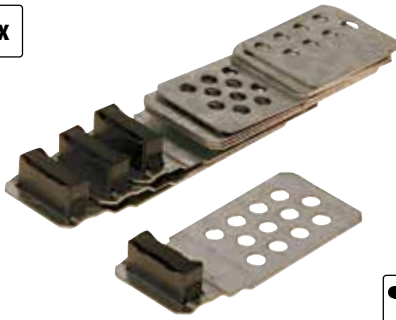

4x

Č.p.
38920

1

MAGNETY STAVITELNÉ POD OBKLADY



4x

Č.p.
38923

24

ROŽKY STAVEBNÍ - SADA

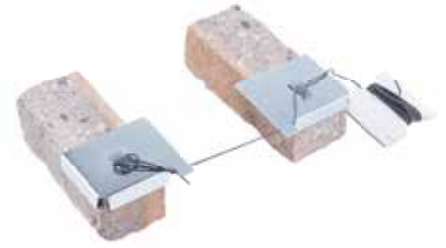
Č.p.
38919

50

MONTÁŽNÍ SADA NA PLOVOUCÍ PODLAHY

24x

Č.p.
52130

1

MONTÁŽNÍ KLÍNKY - PLAST

50x



Č.p.	specifikace	ks	1
37210	95 x 45 x 15 - 0 mm	50	1
37211	70 x 30 x 8 - 0 mm	50	1

POLŠTÁŘEK MONTÁŽNÍ, ROZPÍNACÍ



- rozměr 15x17 cm
- max. výška 5 cm

Č.p.
37220

1

VYMEZOVACÍ PODLOŽKY

30x

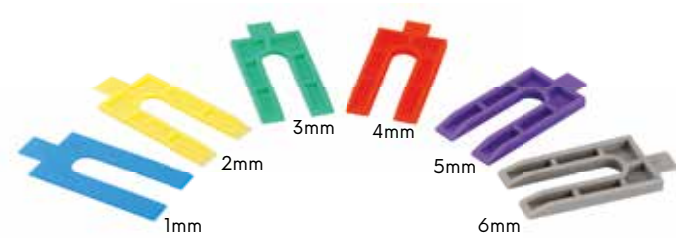
Č.p.
37212

specifikace

1 - 6 mm, 5 ks každé velikosti

1

MONTÁŽNÍ KLÍNKY - DŘEVO

FESTA



Č.p.	specifikace	ks	1
37204	55 x 20 x 0 - 6 mm	20	1
37203	65 x 18 x 0 - 12 mm	20	1
37202	80 x 25 x 3 - 10 mm	20	1
37201	100 x 25 x 1 - 16 mm	14	1
37200	150 x 25 x 1 - 25 mm	8	1
37205	55 x 8 x 0 - 10 mm	250	1

PISTOLE SPÁROVACÍ

Č.p.
38026

specifikace

5x špička

1

PYTEL SPÁROVACÍ

MADE IN EU

Č.p.
38042

specifikace

3x špička

1

KŘÍŽKY DISTANČNÍ

100x



· opakovaně použitelné

Č.p.	specifikace	ks	
37195	1,0 mm	100	12
37196	1,5 mm	100	12
37197	2 mm	100	12
37198	3 mm	100	12

KŘÍŽKY OBKLADAČSKÉ

FESTA



Č.p.	specifikace	ks		Č.p.	specifikace	ks	
37148	1,0 mm	200	100	37152	3 mm	150	100
37149	1,5 mm	200	100	37153	4 mm	100	100
37150	2 mm	200	100	37154	5 mm	75	100
37151	2,5 mm	200	100	37158	10 mm	30	100

KLÍNKY OBKLADAČSKÉ

FESTA



Č.p.	specifikace	ks	
37155	0 - 8 mm	30	100
37156	0 - 4 mm	100	100
37157	2,5 - 8 mm	30	100

MONTÁŽNÍ KLÍNKY - DŘEVO

FESTA

250x



Č.p.	specifikace	ks	
37205	55 x 8 x 0 - 10 mm	250	1

DISTANČNÍ KLIP SE ZÁVITEM

50x



Č.p.	specifikace	
37131	1 mm	40
37132	2 mm	40

KLOBOUČEK NIVELAČNÍ SE ZÁVITEM

50x



· opakovaně použitelné

Č.p.	
37130	15



DISTANČNÍ SPONY

50x



· nivelační klínky 37175, 37176

Č.p.	specifikace	ks	
37170	1 mm	50	60
37171	2 mm	50	60
37172	3 mm	50	60

DISTANČNÍ SPONY

600x



Č.p.	specifikace	ks	krabice	
37125	1 mm	600	38 x 28 x 19 cm	1
37126	1,5 mm	600	38 x 28 x 19 cm	1
37127	2 mm	600	38 x 28 x 19 cm	1

NIVELAČNÍ KLÍNKY



Č.p.	ks	
37175	50	40
37176	400	3

KLEŠTĚ NIVELAČNÍ



Č.p.	
37177	1

DISTANČNÍ SPONY

100x



Č.p.	specifikace	ks		Č.p.	specifikace	ks	
37185	1 mm	100	1	37187	3 mm	100	1
37190	1,5 mm	100	1	37188	4 mm	100	1
37186	2 mm	100	1	37189	5 mm	100	1

NIVELAČNÍ SADA



Č.p.	specifikace	
37173	spony 1 mm, 400 ks + klínky 200 ks	1
37174	spony 1,5 mm, 400 ks + klínky 200 ks	1



KLEŠTĚ NIVELAČNÍ



Č.p.	
37178	1

PUDR 180 G

FESTA

Č.p.	specifikace	
37096	modrý	10
37094	světle modrý	10
37097	červený	10
37095	světle červený	10
37098	černý	10



SADA NAVÍJEČ 30 M + PUDR 150 G

FESTA

- 3x rychlejší mechanismus navíjení
- funkce olovnice



Č.p.
37070

6

SADA NAVÍJEČ 30 M + PUDR 150 G

FESTA

- 5x rychlejší mechanismus navíjení



Č.p.
37065

6

SADA NAVÍJEČ ABS 30 M + PUDR 180 G



Č.p.
37069

10

NAVÍJEČ ABS 30 M



Č.p.
37067

25

NAVÍJEČ PLASTOVÝ 30 M



Č.p.
37066

25

NAVÍJEČ KOVOVÝ 30 M

ALU

Č.p.
37068

25

PROVÁZEK ČERVENÝ

FESTA

PROVÁZEK ŽLUTÝ

FESTA



Č.p.	specifikace	
38895	50 m	24
38896	100 m	24

Č.p.	specifikace	
38899	50 m	24
38900	100 m	24

PROVÁZEK ZEDNICKÝ POLYETYLEN 50 M

FESTA

PROVÁZEK ZEDNICKÝ POLYETYLEN 50 M

FESTA



Č.p.	specifikace	
38907	červený 1,0 mm	100
38908	červený 1,7 mm	100
38909	červený 2,0 mm	100

Č.p.	specifikace	
38904	žlutý 1,0 mm	100
38905	žlutý 1,7 mm	100
38906	žlutý 2,0 mm	100

PROVÁZEK ZEDNICKÝ POLYETYLEN 50 M

FESTA

PROVÁZEK ZEDNICKÝ POLYETYLEN 50 M

FESTA



Č.p.	specifikace	
38910	oranžový 1,0 mm	100
38911	oranžový 1,7 mm	100
38912	oranžový 2,0 mm	100

Č.p.	specifikace	
38901	bílý 1,0 mm	100
38902	bílý 1,7 mm	100
38903	bílý 2,0 mm	100

ŠŤŮRA VOSKOVANÁ



OLOVNICE S PROVÁZKEM 15 M

FESTA

OLOVNICE

FESTA

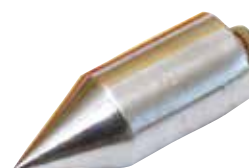

Č.p.	délka	Ø	
50920	50 m	1 mm	80

Č.p.	specifikace	
38916	150 g	10
38917	300 g	10
38918	500 g	10

Č.p.	specifikace	
38913	150 g	5
38914	300 g	5
38915	500 g	5

ŘEZAČKA POLYSTYRENU STRUNOVÁ



- napětí/frekvence: 230 V / 50 Hz
- příkon: 160 W
- délka řezu: 137 cm
- výška řezu: 30 cm
- krytí: IP44
- úhel řezu: 0° - 90°

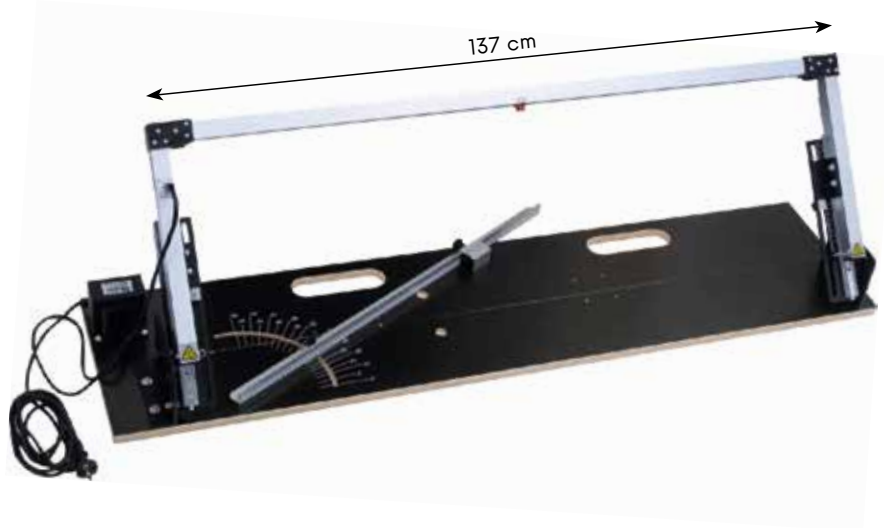
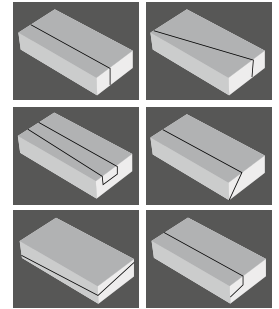

- vybavení: Ni-Cr řezací drát, čisticí mosazný kartáč, inbus



Č.p.	specifikace	
35345	Řezačka polystyrenu 1500 x 450 mm	1
35346	Náhradní řezná struna Ni-Cr	1
35347	Náhradní zdroj	1

ŘEZAČKA POLYSTYRENU STRUNOVÁ



- napětí/frekvence: 230 V / 50 Hz
- příkon: 160 W
- délka řezu: 120 cm
- výška řezu: 30 cm
- krytí: IP44
- úhel řezu: 0° - 90°

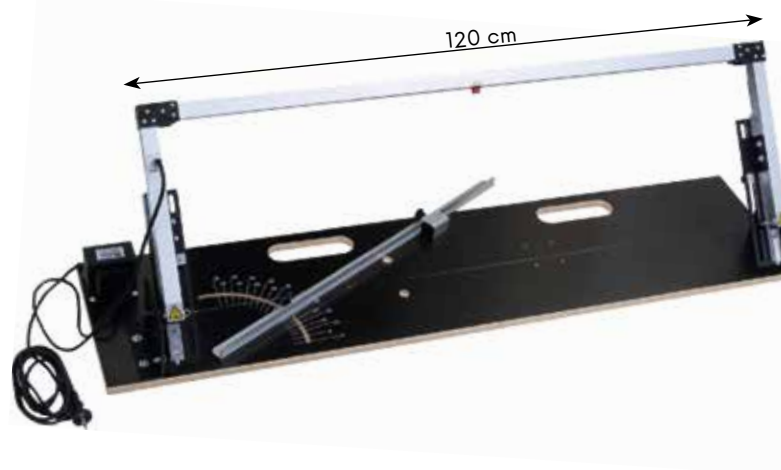
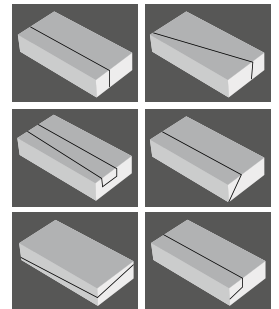

- vybavení: Ni-Cr řezací drát, čisticí mosazný kartáč, inbus



Č.p.	specifikace	
35330	Řezačka polystyrenu 1350 x 450 mm	1
35331	Náhradní řezná struna Ni-Cr	1
35347	Náhradní zdroj	1

ŘEZAČKA POLYSTYRENU AKUMULÁTOROVÁ



- baterie:
- výkon:
- teplota:
- délka čepele:

36 V, 1,5 Ah Li-ion
180 W
max 350 C°
20 cm



FESTA®

Li-ion
technology

- vybavení: 2 ks baterie, nabíječka, čepel, čistící mosazný kartáč, inbus

Č.p. specifikace
35323



1

ŘEZAČKA POLYSTYRENU ELEKTRICKÁ



- napětí / frekvence:
- příkon:
- teplota:
- délka čepele:
- délka přívodního kabelu:

230 V / 50 Hz
250 W
50-600 C°
25 cm
3 m



- vybavení: čistící mosazný kartáč, inbus, nůž 25 cm, kufr

Č.p.	specifikace	
35326	Elektrická řezačka polystyrenu	1
35328	Náhr. nůž do řezačky polystyrenu 14 cm	1
35329	Náhr. nůž do řezačky polystyrenu 25 cm	1

FESTA®

VODÍCÍ LIŠTA PRO ŘEZAČKU POLYSTYRENU



- pro 35323, 35326



Č.p.	specifikace	
35327	Vodící lišta	1
35335	Náhradní nůž - 30 cm	1

ŘEZAČKA POLYSTYRENU ELEKTRICKÁ



- regulace teploty

Č.p. specifikace
35325 220 W



1



1

PODLOŽKA ZATEPLOVACÍ



MOQ

Č.p.	specifikace	
39206	Ø 40 mm	200
39207	Ø 60 mm	100

PODLOŽKA RABICOVÁ

1000x



Č.p.	specifikace	
42420	Ø 30 mm	1

HMOŽDINKA FASÁDNÍ

100x



Č.p.	specifikace		Č.p.	specifikace	
39210	Ø 10 x 100 mm	1	39218	Ø 10 x 180 mm	1
39212	Ø 10 x 120 mm	1	39217	Ø 10 x 200 mm	1
39214	Ø 10 x 140 mm	1	39219	Ø 10 x 220 mm	1
39216	Ø 10 x 160 mm	1			

FRÉZKA DO POLYSTYRENU



Č.p.	specifikace	
24727	Ø 65 mm	1
24729	Ø 68 mm	1
24728	Ø 70 mm	1

ROH PLASTOVÝ



Č.p.	specifikace	
39234	2 m	25
39238	3 m	25

ROH HLINÍKOVÝ

ALU



Č.p.	specifikace	
39245	AL 30 m x 5 cm	1

PERLINKA

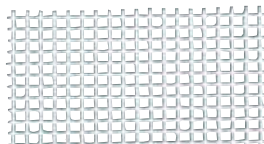

Č.p.	specifikace			
42110	145 g/m ²	4 x 5 mm	1 m x 50 m	1
42112	145 g/m ²	4 x 5 mm	1 m x 10 m	1
42113	145 g/m ²	4 x 5 mm	1 m x 20 m	1

PLETIVO RABICOVÉ

Zn



Č.p.	specifikace	
42312	1 m 50 bm 16 x 16 mm	1

VÁLEČEK NIVELAČNÍ



Č.p.	průměr	výška hrotů	délka	
38950	Ø 69 mm	12 mm	25 cm	10
38951	Ø 69 mm	12 mm	40 cm	8
38952	Ø 122 mm	34 mm	25 cm	10
38953	Ø 122 mm	34 mm	40 cm	8
38954	Ø 122 mm	34 mm	60 cm	4

PODEŠVE S HROTY PÁR



Č.p.	specifikace	
38970	hroty 25 mm	1
38971	hroty 30 mm	1

ZVEDÁK SÁDROKARTONOVÝCH DESEK

- zdvih 153 - 344 cm
- maximální zatížení 54 kg



SADA PRO SÁDROKARTONÁŘE



Č.p.	specifikace	
34300	sada 9 ks	10
34303	vanička	60

Č.p.	specifikace	
26775		1

NOSIČ DESEK



2x



Č.p.	specifikace	
36312		12

NOSIČ DESEK



Č.p.	specifikace	
36308	36 x 16,5 x 7,5 cm	10

OMÍTAČKA

Zn



1

Č.p.
37114

OMÍTAČKA

Zn



1

Č.p. specifikace
37115

SÍTO PROHAZOVACÍ

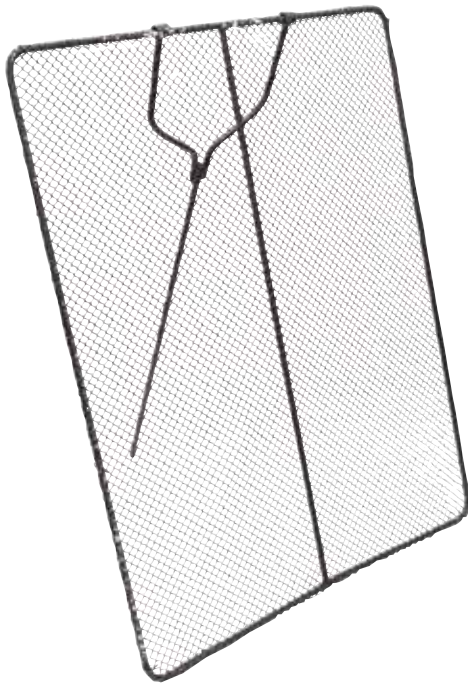

Č.p.	šířka	výška	oko síta	
37236	0,8 m	1 m	10 mm	1
37237	0,8 m	1 m	12 mm	1
37238	0,8 m	1 m	16 mm	1
37239	0,8 m	1 m	20 mm	1

SÍTO NA ŠTUK



Č.p.	šířka	výška	oko síta	
37216	50 mm	50 mm	2 mm	1
37217	50 mm	50 mm	3 mm	1
37218	50 mm	50 mm	4 mm	1

DŘEVĚNÝ OMÍTNÍK



Č.p.	délka	tloušťka	šířka	
37120	200 mm	1,7 mm	20 mm	10
37119	250 mm	1,7 mm	20 mm	10

MOQ
10

10
10

SÍŤ NA LEŠENÍ



Č.p.	specifikace		
42120	2,5 x 20 m, 80 g/ m ²	zelená	5

VLÁKNO VÝZTUŽNÉ DO BETONU 0,9KG



- +/- 150 g/ 50 kg cementu
- 600 - 900 g/m² betonu nebo malty

Č.p.	váha	
42115	0,9 kg	9

KRYT OTVORU MAGNETICKÝ



Č.p.	specifikace	
82101	35 x 35 cm SDK	1
82104	63 x 63 cm SDK	1
82105	25 x 25 cm zdivo	1
82109	63 x 63 cm zdivo	1

SKOBA ZEDNICKÁ KOVANÁ

Zn



Č.p.	specifikace	
37229	14,5 cm	10

SKOBA ZEDNICKÁ POZINKOVANÁ

Zn



Č.p.	specifikace	
37231	14 cm volně	10

SKOBA ZEDNICKÁ KOVANÁ



Č.p.	specifikace	
37232	14,5 cm	5

SKOBA ZEDNICKÁ SADA

6x



Č.p.	specifikace	
37230	16 cm	6

KRAMLE POZINKOVANÁ

Zn



Č.p.	specifikace	
37233	320 x 10 mm	100
37234	320 x 12 mm	100

KRAMLE



Č.p.	specifikace	
37235	250 x 12 mm	1



PB HOŘÁKY

PB HOŘÁK - SADA



Ø 17, 22, 40 mm

Č.p. specifikace

69918 2 kW, 1,5 m hadice



10

PB HOŘÁK - SADA



Ø 25, 35, 50 mm

Č.p. specifikace

69919 19,5 kW, 1,5 m hadice



10

PB HOŘÁK - SADA



Ø 55 mm

Č.p. specifikace

69904 60 kW, 850 mm, 5 m hadice



8

PÁJECÍ SOUPRAVA 3 KW

FESTA

TÜVRheinland
AK 601423580004

Č.p.	specifikace
69914	300 mm + 2 m hadice

5

PB HOŘÁK

FESTA

TÜVRheinland
AK 601423580004

Č.p.	specifikace	
69900	Ø 35 mm, délka 300 mm, bez hadice	10
69901	Ø 35 mm, délka 300 mm + 3 m hadice	5

5

PB HOŘÁK

FESTA

TÜVRheinland
AK 601423580004

Č.p.	specifikace
69902	Ø 55 mm, délka 550 mm, bez hadice

10

PB HOŘÁK

FESTA

TÜVRheinland
AK 601423580004

Č.p.	specifikace	
69903	Ø 55 mm, délka 550 mm + 3 m hadice	10

10

PB HOŘÁK

FESTA

TÜVRheinland
AK 601423580004

Č.p.	specifikace
69905	Ø 55 mm, délka 850 mm, bez hadice

10

PB HOŘÁK

FESTA

TÜVRheinland
AK 601423580004

Č.p.	specifikace	
69906	Ø 55 mm, délka 850 mm + 3 m hadice	5

5

PB HOŘÁK - SADA S REDUKČNÍM VENTILEM

FESTA



· redukční ventil pro připojení 10 a 33 kg bomby



Č.p.

specifikace

69917 Ø 55 mm, délka 850 mm + 3 m hadice 3 m

1

HADICE PRO PB HOŘÁK

FESTA



Č.p.

specifikace

69910 3 m s koncovkami
69911 5 m s koncovkami
69912 10 m s koncovkami

20

12

8

HOŘÁK PLYNOVÝ NA KARTUŠI SE ZÁVITEM

FESTA



· max. teplota:
· výkon:
· průměr hořáku:

1200 °C
1,7 kW
Ø 20 mm



20

Č.p.

specifikace

69930 piezo

HOŘÁK PLYNOVÝ NA PROPICHOVACÍ KARTUŠI

FESTA



· max. teplota:
· výkon:
· průměr hořáku:

1200 °C
1,7 kW
Ø 20 mm



12

Č.p.

specifikace

69931 piezo

REDUKČNÍ VENTIL PROPAN BUTAN



Č.p. specifikace
69923 W 21,8; G 3/8; 4 bar

1

REDUKČNÍ VENTIL PROPAN BUTAN



výstupní tlak	4,0 bar
jmenovitý průtok	16 kg h
připojení - vstup	W 21,8 x 1 14" LH
připojení - výstup	G3 8" LH

Č.p. specifikace
69920

25

REDUKČNÍ VENTIL PROPAN BUTAN



vstupní tlak	25 bar
výstupní tlak	0,5 - 4,0 bar
jmenovitý průtok	16 kg h
připojení - vstup	W 21,8 x 1 14" LH
připojení - výstup	G3 8" LH

Č.p. specifikace
69907

1



JEDNOCESTNÝ UZAVÍRACÍ VENTIL



výstup G 3/8L, pro 2 kg PB láhev

Č.p. specifikace
69928

1

REGULÁTOR TLAKU



Č.p. specifikace
69908 30 mBar, trn
69909 30 mBar, závit G 1/4L

1

1

MISKA NA SÁDRU



Č.p.	specifikace	
37121	kónická	1

MISKA NA SÁDRU



Č.p.	specifikace	
37122	nízká	1

MISKA NA SÁDRU



Č.p.	specifikace	
33275	nízká gumová	20



VĚDRO POZINKOVANÉ

Zn



Č.p.	specifikace	
39000	5 l	40
39001	10 l	30
39002	12 l	20
39003	15 l	20

VĚDRO ZEDNICKÉ



Č.p.	specifikace	
39005	5 l	1
39010	10 l	1
39012	12 l	1
39014	15 l s nálevkou	1
39020	20 l	1
39021	20 l s nálevkou	1



NÁDOBA PLAST - PRUŽNÁ



Č.p.	specifikace	
39192	30 l	20
39193	45 l	20



ZEDNICKÁ NÁDOBA KRUHOVÁ



Č.p.	specifikace	
39045	45 l Ø 54 x 27 cm	1
39065	60 l Ø 60 x 35 cm	1
39090	90 l Ø 66 x 35 cm	1



ZEDNICKÁ NÁDOBA OBDÉLNÍKOVÁ



Č.p.	specifikace	
39145	45 l 71 x 40 x 21 cm	1
39165	65 l 71 x 40 x 30 cm	1
39190	85 l 77 x 48 x 30 cm	1



KLADKA ZEDNICKÁ Z 500



Č.p.	specifikace	
26780	0,5 t A s hákem	1
26781	0,5 t B s okem	1
26782	0,5 t C s hákem a chráničem	1
26783	0,5 t D s okem a chráničem	1

FOLIE SMRŠŤOVACÍ



Č.p.	šířka	délka	pevnost materiálu	
38095	500 mm	600 m	8 µm čirá	1
38097	100 mm	150 m	20 µm čirá	1
38096	500 mm	200 m	23 µm černá	1

PE PYTLE NA SUŠ
TRANSPARENTNÍ

Č.p.	šířka	délka	tloušťka	objem	ks	
39194	500 mm	1100 mm	0,16 mm	100	1	10
39196	600 mm	1200 mm	0,16 mm	110	1	10
39198	700 mm	1100 mm	0,16 mm	120	1	10
39200	500 mm	1100 mm	0,20 mm	100	1	10
39202	600 mm	1200 mm	0,20 mm	110	1	10
39204	700 mm	1100 mm	0,20 mm	120	1	10



PE PYTLE NA SUŠ ČERNÉ



Č.p.	šířka	délka	tloušťka	objem	ks	
39195	500 mm	1100 mm	0,16 mm	100	1	10
39197	600 mm	1200 mm	0,16 mm	110	1	10
39199	700 mm	1100 mm	0,16 mm	120	1	10
39201	500 mm	1100 mm	0,20 mm	100	1	10
39203	600 mm	1200 mm	0,20 mm	110	1	10
39205	700 mm	1100 mm	0,20 mm	120	1	10



PYTLE NA ODPAD



Č.p.	šířka	délka	tloušťka	ks	
38060	700 mm	1100 mm	0,08 mm	10	1
38063	700 mm	1100 mm	0,10 mm	3	1
38065	700 mm	1100 mm	0,20 mm	3	1



SÁČKY NA ODPAD



Č.p.	šířka	délka	tloušťka	ks	
38050	500 mm	600 mm	0,04 mm	25	1
38052	600 mm	800 mm	0,04 mm	25	1
38054	700 mm	1100 mm	0,04 mm	25	1



PE PYTLE NA ODPAD

5x



FÓLIE POLOHADICE



polohadice



Č.p.	šířka	délka	tloušťka	
38055	1200 mm	1000 mm	0,08 mm	5

Č.p.	šířka	tloušťka	specifikace	
38089	1,2 m	0,1mm 150 bm	polohadice	1

ÚVAZEK PYTLUVÝ



1000x



Č.p.	specifikace	
42365	1,25 100 mm	1
42366	1,25 125 mm	1
42367	1,25 140 mm	1
42368	1,25 160 mm	1

VAZAČ PYTLŮ



Č.p.	specifikace	
50052		12
50050		1

VAZAČ ÚVAZKŮ - RÁDLLOVAČKA



Č.p.	specifikace	
50051		2

FOLIE VÝSTRAŽNÁ - EL. VEDENÍ



Č.p.	šířka	délka	
38955	22 cm	20 m	1
38956	22 cm	50 m	1

FOLIE VÝSTRAŽNÁ - VODA



Č.p.	šířka	délka	
38957	22 cm	20 m	1
38958	22 cm	50 m	1

FOLIE VÝSTRAŽNÁ - PLYN



Č.p.	šířka	délka	
38959	22 cm	20 m	1
38960	22 cm	50 m	1

PÁSKA VAROVACÍ



Č.p.	specifikace	délka	
38944	ZÁKAZ VSTUPU, SK	80 mm 250 m	8
38945	VSTUP ZAKÁZÁN, CZ	80 mm 250 m	8

PÁSKA VAROVACÍ



Č.p.	délka	
38948	80 mm 250 m	8

PÁSKA VAROVACÍ

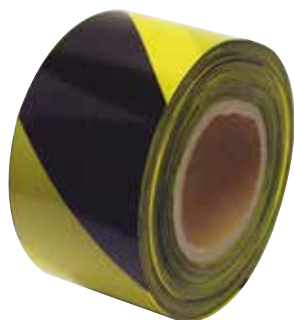

Č.p.	délka	
38946	80 mm 250 m	8

PÁSKA VAROVACÍ - SAMOLEPICÍ



Č.p.	délka	specifikace	
38947	48 mm 33 m	pravá	48
38961	48 mm 33 m	levá	48

PÁSKA TRASOVACÍ



Č.p.	šířka	délka	tloušťka materiálu	
38949	50 mm	50 m	0,15 mm	36

BEZPEČNOSTNÍ SÍŤ

140 g/m²
UV STABLE

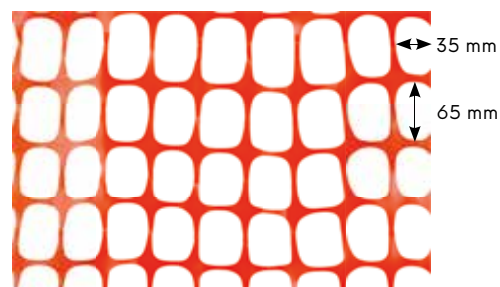

Č.p.	specifikace	
42190	1,2 x 50 m HDPE 140g/m ²	1

PÁSKY PVC

5x



Č.p.	šířka	délka	tloušťka materiálu	
38931	19 mm	5 m	0,13 mm	100

PÁSKA PVC - ČERNÁ



Č.p.	šířka	délka	tloušťka materiálu	
38932	19 mm	10 m	0,13 mm	10

PÁSKA PVC



Č.p.	šířka	délka	tloušťka materiálu	
38925	19 mm	10 m	0,13 mm	10

PÁSKA PVC, ČERNÁ



Č.p.	šířka	délka	tloušťka materiálu	
38968	19 mm	10 m	0,19 mm	10

PÁSKA TEXTIL ČERNÁ



Č.p.	šířka	délka	
38927	19 mm	10 m	10

PÁSKA TEXTILNÍ, KOBERCOVÁ



Č.p.	šířka	délka	
38980	48 mm	10 m	24
38981	48 mm	20 m	24

PÁSKA LEPICÍ OBOUSTRANNÁ S VÝTUŽÍ



Č.p.	šířka	délka	
38924	50 mm	10 m	1
38964	50 mm	25 m	1

PÁSKA LEPICÍ OBOUSTRANNÁ, POLYPROPYLEN

PP
Polypropylen

Č.p.	šířka	délka	
38929	50 mm	10 m	1
38966	50 mm	25 m	1

PÁSKA LEPICÍ OBOUSTRANNÁ MONTÁŽNÍ

MADE IN
EU

Č.p.	šířka	délka	
38990	19 mm	5 m	48
38991	25 mm	5 m	36

PÁSKA PROFESIONÁLNÍ ZESÍLENÁ, VODĚODOLNÁ

FESTA

MADE IN EU

Č.p.	šířka	délka	
38995	48 mm	25 m	24

PÁSKA TEXTILNÍ, VODĚODOLNÁ



Č.p.	šířka	délka	
38965	30 mm	10 m	1
38928	50 mm	10 m	72
38934	50 mm	45 m	24

PÁSKA DUCT TAPE, VODĚODOLNÁ

MADE IN EU

Č.p.	šířka	délka	
37275	48 mm	50 m	24

PÁSKA FASÁDNÍ NA OMÍTKU

MADE IN EU

Č.p.	šířka	délka	
37271	38 mm	20 m	24
37270	48 mm	20 m	24
37272	48 mm	50 m	24

PÁSKA PE VENKOVNÍ OCHRANA NA OKNA



po dobu 30 dní

MADE IN EU

Č.p.	šířka	délka	
37273	48 mm	50 m	24

PÁSKA PROFI PAPIŘOVÁ MASKOVACÍ

MADE IN EU

Č.p.	šířka	délka	
37263	38 mm	50 m	24
37264	48 mm	50 m	24

PÁSKA PVC MASKOVACÍ

MADE IN EU

Č.p.	šířka	délka	
37266	30 mm	33 m	60
37267	38 mm	33 m	48
37268	50 mm	33 m	36

PÁSKA PAPIŘOVÁ MASKOVACÍ

MADE IN EU

Č.p.	šířka	délka	
37255	19 mm	50 m	12
37256	25 mm	50 m	12
37257	30 mm	50 m	7
37258	38 mm	50 m	6
37259	50 mm	50 m	6

PÁSKA BALÍCÍ PVC

MADE IN EU

Č.p.	šířka	délka	
38942	50 mm	50 m	72

PÁSKA POKOVENÁ

NEW

ALU

UV
STABLE

Č.p.	šířka	délka	
38972	50 mm	50 m	1
38973	50 mm	100 m	1

FÓLIE HLINÍKOVÁ SAMOLEPÍCÍ

ALU



Č.p.	šířka	délka	
38963	48 mm	10 m	1
38943	48 mm	45 m	24

PÁSKA PROTISLUZOVÁ



Č.p.	šířka	délka	tloušťka	
37280	25 mm	15 m	0,8 mm	72
37281	50 mm	15m	0,8 mm	36

PÁSKA SAMOVULKANIZAČNÍ



Č.p.	šířka	délka	
38930	19 mm	5 m	100

PÁSKA SÁDROKARTONÁŘSKÁ SAMOLEPÍCÍ

MADE IN
EU

Č.p.	šířka	délka	
38935	50 mm	20 m	60
38937	50 mm	45 m	36
38939	50 mm	90 m	24
38940	50 mm	153 m	24

PÁSKA SKLOVLÁKNOVÁ

MADE IN
EU

Č.p.	šířka	délka	
38941	50 mm	25 m	40

PÁSKA INSTALATÉRSKÁ TEFLONOVÁ

TEFLON



Č.p.	šířka	délka	tloušťka materiálu	
38969	19 mm	15 m	0,2 mm	10

PÁSKA INSTALATÉRSKÁ TEFLONOVÁ

TEFLON



Č.p.	šířka	délka	tloušťka materiálu	
38933	12 mm	10 m	0,075 mm	10

NIT TEFLONOVÁ

TEFLON

· na vodo. a plyn. instalace



Č.p.	šířka	délka	
38926	2 mm	150 m	20

ODVÍJEČ PÁSKY



Č.p.	
38985	1

VÁZACÍ PÁSKA, SUCHÝ ZIP



Č.p.	specifikace	
45471	12 mm x 5 m	1

PÁSKA NA SUCHÝ ZIP 3 KS

3x

FESTA



Č.p.	šířka	délka	
37295	20 mm	150 mm	1
37296	20 mm	200 mm	1
37297	20 mm	250 mm	1

PISTOLE VYTLAČOVACÍ ZESÍLENÁ

FESTA



Č.p. specifikace
38013

12

PISTOLE VYTLAČOVACÍ

FESTA



Č.p. specifikace
38001

24

PISTOLE VYTLAČOVACÍ

FESTA



Č.p. specifikace
38012

6

PISTOLE VYTLAČOVACÍ

FESTA

NEW



Č.p. specifikace
38024

1

PISTOLE VYTLAČOVACÍ SE ZPĚTNÝM ODSKOKEM



Č.p. specifikace
38010 6ti hran

24

PISTOLE VYTLAČOVACÍ



Č.p. specifikace
38025

24

PISTOLE VYTLAČOVACÍ NA CHEMICKÉ KOTVY 380 ML **FESTA**



Č.p. specifikace
38020

12

PISTOLE VYTLAČOVACÍ - KROKOVÁ



Č.p. specifikace
38006

12

PISTOLE VYTLAČOVACÍ

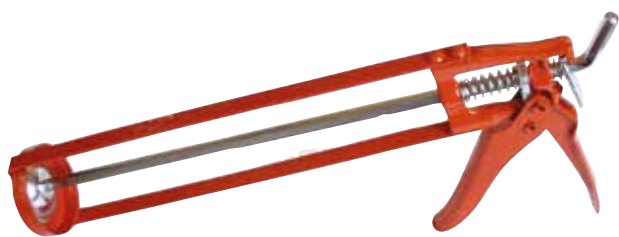

Č.p.	specifikace	
38002	6ti hran	24

PISTOLE VYTLAČOVACÍ - PLASTOVÁ



Č.p.	specifikace	
38003	6ti hran	24

PISTOLE VYTLAČOVACÍ



Č.p.	specifikace	
38007		24

PISTOLE VYTLAČOVACÍ - PLASTOVÁ, POLOUZAVŘENÁ



Č.p.	specifikace	
38008		24

PISTOLE VYTLAČOVACÍ OZUBENÁ



Č.p.	specifikace	
38009		24

PISTOLE VYTLAČOVACÍ



Č.p.	specifikace	
38000		24

PISTOLE VYTLAČOVACÍ

FESTA

Č.p.	specifikace	
38005	310 ml	20
38014	špička 3 ks	100

PISTOLE VYTLAČOVACÍ

FESTA

Č.p.	specifikace	
38004	600 ml	12
38014	špička 3 ks	100

PISTOLE NA PU PĚNY S TEFLONOVÝM POVRCHEM

FESTA

TEFLON



20

Č.p. specifikace

38018

PISTOLE NA PU PĚNY S TEFLONOVÝM POVRCHEM

FESTA

TEFLON



20

Č.p. specifikace

38017

PISTOLE NA PU PĚNY

FESTA

TEFLON



20

Č.p. specifikace

38016

PISTOLE NA PU PĚNY

FESTA

TEFLON



20

Č.p. specifikace

38015

PISTOLE NA PU PĚNY

NEW



20

Č.p. specifikace

38031

PISTOLE NA PU PĚNY ABS

FESTA



Č.p. specifikace

38022 ABS

20

PISTOLE NA PU PĚNY



Č.p. specifikace

38021

24



TRYSKA NÁHRADNÍ NA PISTOLE

TEFLON



· pro pistole 38015, 38016, 38017, 38018

Č.p. specifikace
38030

5

PISTOLE SPÁROVACÍ



· objem 1,5 l

Č.p. specifikace
38026 5x špička

25

PYTEL SPÁROVACÍ

Č.p. specifikace
38042 3x špička

6

PISTOLE HORKOVZDUŠNÁ S REGULACÍ TEPLoty



FESTA



napětí / frekvence	230V / 50Hz
příkon	2000W
poloha spínače	0 - I (350°C) - II (600°C)
příslušenství	nerezové nástavce - 4 ks

Č.p. specifikace
35320 2000 W

1

PISTOLE HORKOVZDUŠNÁ S REGULACÍ TEPLoty A PROUDU VZDUCHU



FESTA

· digitální display



napětí / frekvence	230V / 50Hz
příkon	2000W
poloha spínače	0 - I (50°C) - II (50 - 600°C)
proud vzduchu	250 - 500 l/min.
příslušenství	nerezové nástavce - 4 ks

Č.p. specifikace
35322 2000 W

1



TAVNÉ PISTOLE

PISTOLE TAVNÁ - BEZDRÁTOVÁ



· Ø tavné tyčinky 11,2 mm



Č.p. 89975 specifikace 80 W | 230 V



PISTOLE TAVNÁ



· Ø tavné tyčinky 7,2 mm

Č.p. 89970 specifikace 15 W | 230 V



PISTOLE TAVNÁ



· Ø tavné tyčinky 11,2 mm

Č.p. 89973 specifikace 60 W | 230 V



TYČINKY DO TAVNÉ PISTOLE - ČIRÉ

TYČINKY DO TAVNÉ PISTOLE - ČIRÉ

TYČINKY DO TAVNÉ PISTOLE - BAREVNÉ



Č.p.	Ø tyčinky	délka		
89980	7,2 mm	100 mm	12 ks	100
89988	7,2 mm	100 mm	1 kg	25

Č.p.	Ø tyčinky	délka		
89985	11,2 mm	200 mm	10 ks	50
89987	11,2 mm	200 mm	1 kg	25

Č.p.	Ø tyčinky	délka		
89989	7,2 mm	100 mm	12 ks	100
89990	11,2 mm	200 mm	10 ks	50



ŠTĚTCE A VÁLEČKY

ŠTĚTEC PLOCHÝ NATUR



Č.p.	šířka	tloušťka	délka	
52212	20 mm	15 mm	40 mm	12
52213	30 mm	15 mm	45 mm	12
52214	40 mm	15 mm	45 mm	12
52215	50 mm	15 mm	50 mm	12
52216	60 mm	15 mm	60 mm	12
52217	70 mm	15 mm	65 mm	12
52218	80 mm	15 mm	65 mm	12
52220	100 mm	15 mm	70 mm	12

ŠTĚTEC PLOCHÝ



Č.p.	šířka	tloušťka	délka	
52202	20 mm	12,5 mm	38 mm	12
52203	30 mm	13 mm	38 mm	12
52204	40 mm	14 mm	44 mm	12
52205	50 mm	16 mm	44 mm	12
52206	60 mm	17 mm	52 mm	12
52208	80 mm	17 mm	52 mm	12
52207	100 mm	18 mm	52 mm	12

ŠTĚTEC ZÁROHOVÝ



Č.p.	šířka	tloušťka	délka	
52283	25 mm	10 mm	44 mm	12
52284	38 mm	10 mm	44 mm	12
52285	50 mm	10 mm	44 mm	12
52286	62 mm	10 mm	50 mm	12
52288	76 mm	10 mm	50 mm	12

SADA ŠTĚTCŮ - PLASTOVÁ RUKOJEŤ

3x



Č.p.	specifikace	
52070	20, 30, 50 mm	50

SADA ŠTĚTCŮ - PLASTOVÁ RUKOJEŤ

5x



50

Č.p.

specifikace

52071 15 mm, 25 mm, 40 mm, 60 mm, 80 mm

ŠKRABKA NA BARVY A LAKY



12

Č.p.

37005

MALÍŘSKÁ ŠTĚTKA PROFÍ



10

Č.p.

specifikace

52075 Ø 90 mm

MALÍŘSKÁ ŠTĚTKA



12

Č.p.

specifikace

délka

52077 Ø 105 mm 70 mm

MALÍŘSKÁ ŠTĚTKA PROFÍ



10

Č.p.

šířka

délka

52076 170 mm 80 mm

MALÍŘSKÁ ŠTĚTKA



12

Č.p.

šířka

délka

52078 170 mm 70 mm



TABULKA POUŽITÍ MALÍŘSKÝCH VÁLEČKŮ		BARVY A LAKY												
MATERIÁL	VÝŠKA VLASU l mm	DISPERZNÍ	ANTIKOROZÍ	PRYSKYŘIC.	OLEJOVÉ	VODOU ŘED.	POLYESTEROVÉ	POJIVOVÉ	LAZURY	LATEXOVÉ	EPOXYDOVÉ	2-KOMPONENTNÍ	HUSTÉ	AKRYLOVÉ
PES	20	•						•		•			•	
PES	20	•	•			•		•		•				•
PAC	18	•						•		•				
PAC	12, 13	•								•				
PAD	18, 21	•								•				
PAD	13	•	•							•				
BERÁNEK	23	•								•				
NYLON	13		•	•	•	•	•			•	•	•		
VELOUR	4		•	•			•				•	•	•	
MICROFIBRE	10					•			•	•				
MOLITAN				•		•								•



MALÍŘSKÉ VÁLEČKY

PENETRAČNÍ SOUPRAVA

MADE IN EU

PAC



č.p.

52600 polster 4 180 mm Ø 8 mm Ø 53 mm 18 mm 1



MALÍŘSKÁ SOUPRAVA - VESTAN

MADE IN EU

PES

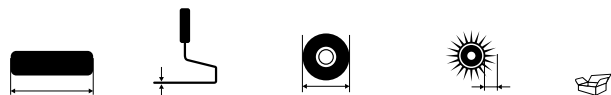

č.p.

52610 180 mm Ø 6 mm Ø 42 mm 20 mm 25
52605 250 mm Ø 6 mm Ø 42 mm 20 mm 20

LAKOVACÍ SADA

MADE IN EU

- 1x váleček PAD 13mm/ 10 cm
- 1x váleček PAC 12mm/ 10 cm
- 1x váleček PES 11mm/ 10 cm
- držák
- miska



č.p.

52602 10



VÁLEČEK POLYAKRYL



PAC



Č.p.					
52331	100 mm	Ø 6 mm	Ø 17 mm	12 mm	50
52334	250 mm	Ø 8 mm	Ø 48 mm	12 mm	10

VÁLEČEK POLYAKRYL



PAC



Č.p.					
52391	polster 5 250 mm	Ø 8 mm	Ø 54 mm	18 mm	10

VÁLEČEK POLYAKRYL



PAC



Č.p.					
52328	polster 5 250 mm	Ø 8 mm	Ø 54 mm	18 mm	10
52456	polster 7 250 mm	Ø 8 mm	Ø 67 mm	18 mm	10

VÁLEČEK POLYAMID



PAD



Č.p.					
52428	polster 7 250 mm	Ø 8 mm	Ø 67 mm	18 mm	10

VÁLEČEK POLYESTER



PES



Č.p.					
52315	polster 5 180 mm	Ø 8 mm	Ø 54 mm	20 mm	10

VÁLEČEK LAZUROVACÍ - NYLON



PAD



Č.p.					
52421	100 mm	Ø 6 mm	Ø 17 mm	13 mm	50
52424	250 mm	Ø 8 mm	Ø 48 mm	13 mm	10

VÁLEČEK POLYESTER



PES



Č.p.					
52305	180 mm	Ø 6 mm	Ø 42 mm	20 mm	10
52306	250 mm	Ø 6 mm	Ø 42 mm	20 mm	10

VÁLEČEK LAKOVACÍ MOLITAN



Č.p.	rovný	100 mm	Ø 6 mm	Ø 35 mm	50
52471					

ROHOVÝ VÁLEČEK POLYAKRYL



PAC



Č.p.	včetně držáku	Ø 6 mm	18 mm	1
52601				

TELESKOPICKÁ TYČ

ALU



Č.p.	délka	ALU	50
52010	120 cm		
52012	240 cm		25

TELESKOPICKÁ TYČ



Č.p.	délka	ocel	10
52020	300 cm		

TELESKOPICKÁ TYČ



Č.p.	délka	fiberglass	6
52030	240 cm		

MISKA



Č.p.	specifikace	100 mm	1
52662	150 x 270 mm		
52666	260 x 290 mm	180 mm	
52671	330 x 340 mm	250 mm	

KBELÍK NA BARVU



Č.p.	objem	25	20
52694	8 l		
52695	12 l		

MŘÍŽKA



Č.p.	šířka	výška	
52652	230 mm	250 mm	100
52656	270 mm	290 mm	100

DRŽÁK



Č.p.	specifikace	
52640	5 cm Ø 6 mm	100
52645	8,5 cm Ø 6 mm x 27 mm	100

DRŽÁK



Č.p.	specifikace	
52630	18 cm Ø 6 mm	100
52635	25 cm Ø 6 mm	100
52620	18 cm Ø 8 mm	50
52625	25 cm Ø 8 mm	50

PÁSKA KRYCÍ SAMOLEPÍCÍ S FÓLIÍ



Č.p.	šířka	délka	
37243	55 cm	30 m	60
37244	110 cm	30 m	30
37245	140 cm	30 m	30
37246	180 cm	15 m	30
37290	210 cm	20 m	30
37247	240 cm	15 m	30
37291	270 cm	16 m	30

OCHRANNÁ KOMBINEZA S KAPUCÍ



Č.p.	specifikace	
50585	velikost M	1
50586	velikost L	1
50587	velikost XL	1
50588	velikost XXL	1

FOLIE DO DVEŘÍ SE ZIPEM



Č.p.	specifikace	
37248	1,2 x 2,2 m páska 45 mm x 25 m	25

UNIVERZÁLNÍ KRYCÍ FÓLIE



Č.p.	objem	tloušťka materiálu	
37250	4 x 5 m	0,007 mm	100
37251	4 x 12,5 m	0,007 mm	50
37252	2 x 50 m	0,007 mm	20

UNIVERZÁLNÍ KRYCÍ FÓLIE



Č.p.	specifikace	tloušťka materiálu	
37253	4 x 5 m	0,03 mm	100

LEPENKA VLNITÁ



Č.p.	šířka	délka	
54008	1 m	10 m	1

EKONOMIK **

STANDARD ***

PROFI ****

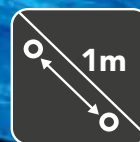

- Zdvojené svažené lemy s polypropylenovou šňůrou
- Stříbrná vrstva pro zvýšený odraz slunečního záření
- ALU oka po 1 m

ZAKRÝVACÍ PLACHTA EKONOMIK

· modrá



Č.p.	specifikace		Č.p.	specifikace	
25369	2 x 2 m	50	25374	4 x 6 m	5
25370	2 x 3 m	20	25376	5 x 8 m	5
25371	3 x 4 m	10	25378	6 x 10 m	2
25372	3 x 5 m	10	25379	8 x 12 m	2
25373	4 x 5 m	10	25380	10 x 15 m	2

ZAKRÝVACÍ PLACHTA STANDARD

· modro-stříbrná



70 g/m²



Č.p.	specifikace		Č.p.	specifikace	
25155	2 x 2 m	50	25025	5 x 5 m	10
25006	2 x 3 m	50	25030	5 x 6 m	10
25009	3 x 3 m	35	25040	5 x 8 m	5
25012	3 x 4 m	20	25048	6 x 8 m	5
25015	3 x 5 m	10	25060	6 x 10 m	5
25016	4 x 4 m	10	25096	8 x 12 m	2
25020	4 x 5 m	10	25150	10 x 15 m	2
25024	4 x 6 m	10	25153	15 x 20 m	1

ZAKRÝVACÍ PLACHTA STANDARD

· zelená



70 g/m²



Č.p.	specifikace		Č.p.	specifikace	
25179	2 x 2 m	50	25184	4 x 6 m	10
25180	2 x 3 m	50	25186	5 x 8 m	5
25195	2 x 8 m	20	25188	6 x 10 m	5
25181	3 x 4 m	20	25189	8 x 12 m	2
25182	3 x 5 m	10	25190	10 x 15 m	2
25183	4 x 5 m	10			

PE PLACHTA PROFI

· modro-stříbrná



140 g/m²



Č.p.	specifikace		Č.p.	specifikace	
25206	2 x 3 m	25	25240	5 x 8 m	4
25212	3 x 4 m	10	25248	6 x 8 m	3
25215	3 x 5 m	8	25260	6 x 10 m	3
25220	4 x 5 m	8	25296	8 x 12 m	2
25224	4 x 6 m	8	25350	10 x 15 m	1
25230	5 x 6 m	8			

PE PLACHTA PROFI

· zeleno-zelená



200 g/m²



Č.p.	specifikace		Č.p.	specifikace	
25160	2 x 3 m	15	25164	4 x 6 m	3
25171	NEW 2 x 8 m	1	25167	6 x 8 m	2
25162	3 x 5 m	5	25169	8 x 12 m	1
25163	4 x 5 m	4	25170	10 x 15 m	1

PE PLACHTA KULATÁ

· modro-stříbrná



120 g/m²



Č.p.	specifikace	
25003	Ø 3,6 m	15
25004	Ø 4,5 m	5
25005	Ø 5,5 m	4
25002	Ø 6,5 m	3

ZAKRÝVACÍ PLACHTA MASKOVACÍ

· maskovací



80 g/m²



Č.p.	specifikace	
25365	5 x 8 m	5
25366	6 x 10 m	2
25367	8 x 12 m	2
25368	10 x 15 m	2



NAPÍNÁK PLACHET

4x



Č.p.	specifikace	
25400	20 cm	1

APLIKÁTOR OK DO PLACHET



Č.p.	specifikace	
25410	aplikátor ok + 25 ok	1

OKA DO PE PLACHET

10x



Č.p.	specifikace	
25001		1





KARABINY, ŘETĚZY A OCELOVÁ LANA

NAPÍNACÍ ŠROUB

DIN 1480

Zn





Č.p.	specifikace		Č.p.	specifikace	
50100	5 x 70 mm	10	50104	12 x 200 mm	10
50101	6 x 90 mm	10	50106	16 x 230 mm	10
50102	8 x 125 mm	10	50108	20 x 220 mm	10
50103	10 x 150 mm	10			

KARABINA

DIN 5299 C

Zn





Č.p.	specifikace		Č.p.	specifikace	
51204	4 mm	10	51209	9 mm	10
51205	5 mm	10	51210	10 mm	10
51206	6 mm	10	51211	11 mm	10
51207	7 mm	10	51212	12 mm	10
51208	8 mm	10			

ČLÁNEK RAPID

Zn





Č.p.	specifikace		Č.p.	specifikace	
51241	4 mm	10	51245	8 mm	10
51242	5 mm	10	51246	10 mm	10
51243	6 mm	10	51247	12 mm	10
51244	7 mm	10			

S HÁK

Zn





Č.p.	specifikace		Č.p.	specifikace	
51271	3 mm	10	51275	7 mm	10
51272	4 mm	10	51276	8 mm	10
51273	5 mm	10	51278	10 mm	10
51274	6 mm	10			

MATICE OČKOVÁ

DIN 5820

Zn





Č.p.	specifikace		Č.p.	specifikace	
51320	6 mm	10	51324	14 mm	10
51321	8 mm	10	51325	16 mm	10
51322	10 mm	10	51327	20 mm	10
51323	12 mm	10			

ŠROUB OČKOVÝ

DIN 5820

Zn



Č.p.	specifikace		Č.p.	specifikace	
51300	6 mm	10	51305	16 mm	10
51301	8 mm	10	51306	18 mm	10
51302	10 mm	10	51307	20 mm	10
51303	12 mm	10	51308	22 mm	10
51304	14 mm	10			

SVĚRKA LANOVÁ

Zn



Č.p.	specifikace		Č.p.	specifikace	
51280	3 mm	10	51284	10 mm	10
51281	5 mm	10	51286	12 mm	10
51282	6 mm	10	51287	14 mm	10
51283	8 mm	10	51288	16 mm	10

LANOVÁ SVĚRKA OTOČNÁ

Zn



Č.p.	specifikace	
51225	3,8 mm	10
51226	4,5 mm	10
51227	6,0 mm	10

ŘETĚZ KRÁTKÉ OKO

DIN 5685 A

Zn



Č.p.	velikost oka	délka		Č.p.	velikost oka	délka	
51402	2 x 10 mm	110 m	1	51406	6 x 24 mm	18 m	1
51403	3 x 16 mm	60 m	1	51407	7 x 50 mm	16 m	1
51404	4 x 21 mm	40 m	1	51408	8 x 32 mm	10 m	1
51405	5 x 23 mm	30 m	1	51410	10 x 39 mm	10 m	1

ŘETĚZ DLOUHÉ OKO

DIN 5685 C

Zn



Č.p.	velikost oka	délka		Č.p.	velikost oka	délka	
51412	2 x 12 mm	80 m	1	51416	6 x 43 mm	18 m	1
51413	3 x 26 mm	60 m	1	51417	7 x 50 mm	16 m	1
51414	4 x 32 mm	38 m	1	51418	8 x 54 mm	10 m	1
51415	5 x 35 mm	32 m	1	51420	10 x 65 mm	10 m	1

KARABINA OTOČNÁ

Zn



Č.p.	specifikace	
51220	53 mm	10
51221	67 mm	10
51222	76 mm	10

ŘETĚZ UZLOVÝ

DIN 5686

Zn



Č.p.	Ø materiálu	délka		Č.p.	Ø materiálu	délka	
51430	1,4 mm	150 m	1	51433	2,0 mm	118 m	1
51431	1,6 mm	150 m	1	51435	2,5 mm	70 m	1
51432	1,8 mm	150 m	1	51436	2,8 mm	50 m	1

ŘETĚZ PLASTOVÝ



Č.p.	specifikace	
51450	6 mm 25 m červeno-bílý	1

SPOJKA LANOVÁ DVOJITÁ

DIN 5685 C

Zn



SPOJKA LANOVÁ

DIN 5685 C

Zn



Č.p.	specifikace	
51348	Ø 10 mm	10

Č.p.	specifikace		Č.p.	specifikace	
51338	Ø 5 mm	10	51341	Ø 10 mm	10
51340	Ø 8	10			

OČNICE PRO LANA

Zn



Č.p.	specifikace	
51257	Ø 14 mm	10
51258	Ø 16 mm	10
51259	Ø 18 mm	10
51260	Ø 20 mm	10
51261	Ø 22 mm	10
51262	Ø 24 mm	10
51263	Ø 26 mm	10
51264	Ø 28 mm	10
51265	Ø 30 mm	10

LANKO OCELOVÉ POZINKOVANÉ

Zn



Č.p.	průměr lana	délka	
51100	Ø 1 mm	500 m	1
51101	Ø 1,2 mm	500 m	1
51102	Ø 1,5 mm	500 m	1
51103	Ø 2 mm	200 m	1
51104	Ø 3 mm	200 m	1
51105	Ø 4 mm	100 m	1
51106	Ø 5 mm	75 m	1
51107	Ø 6 mm	75 m	1
51130	Ø 8 mm	75 m	1
51131	Ø 10 mm	50 m	1
51132	Ø 12 mm	50 m	1

LANKO OCELOVÉ POZINKOVANÉ V PVC OBALU

Zn



Č.p.	průměr lana	délka	
51108	Ø 2/3 mm	200 m	1
51109	Ø 3/4 mm	100 m	1
51110	Ø 4/5 mm	75 m	1
51111	Ø 5/6 mm	50 m	1

LANKO OCELOVÉ NEREZOVÉ

INOX



Č.p.	průměr lana	délka	
51120	Ø 1 mm	300 m	1
51121	Ø 1,2 mm	300 m	1
51122	Ø 1,5 mm	300 m	1
51123	Ø 2 mm	200 m	1
51124	Ø 3 mm	200 m	1
51125	Ø 4 mm	100 m	1
51126	Ø 5 mm	75 m	1
51127	Ø 6 mm	75 m	1

STOJAN PRODEJNÍ NA LANKA A ŘETĚZY

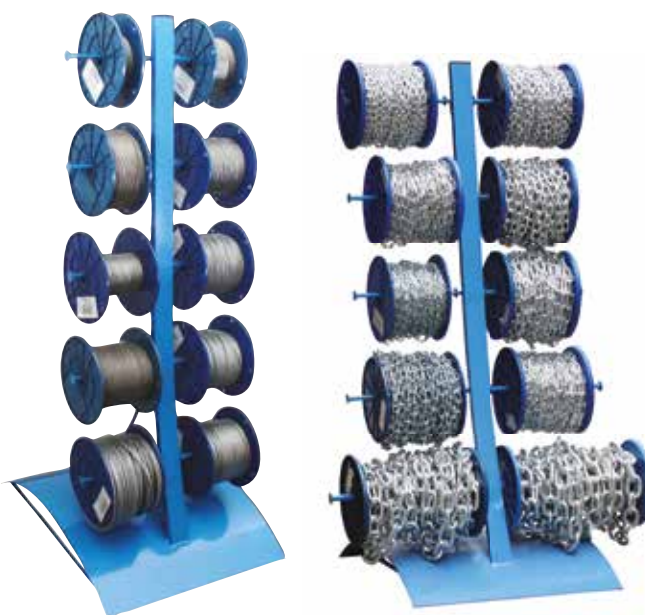

Č.p.	specifikace	
51196	stojan na řetězy osazený	10
51197	stojan na lanka osazený	10
51198	stojan na řetězy	10
51199	stojan na lanka	10

NAVIJÁK S LANEM A HÁKEM

Zn



Č.p.	nosnost	délka lana	
26720	300 kg	8 m	1
26705	450 kg	8 m	1
26721	500 kg	8 m	1
26722	800 kg	8 m	1
26706	900 kg	8 m	1
26707	1350 kg	8 m	1

SVĚTLO STAVEBNÍ LED



20 W



Č.p.	specifikace
37611	1



SVĚTLO STAVEBNÍ HALOGENOVÉ



Č.p.	specifikace	
37600	120 W	1
37601	400 W	1

HALOGENOVÁ ŽÁROVKA



Č.p.	specifikace	
37604	120 W	1
37606	250 W	1
37605	400 W	1

SVĚTLO STAVEBNÍ LED



20 W



· maximální výška 180 cm

Č.p.	specifikace	
37615	20 W	1
37616	2 x 20 W	1

SVĚTLO STAVEBNÍ HALOGENOVÉ



· maximální výška 180 cm

Č.p.	specifikace	
37602	400 W	2
37603	2 x 400 W	2

ŽEBŘÍK TELESKOPICKÝ

ALU

CE EN
131

· max. nosnost 150 kg

Č.p.	specifikace	
48410	3,2 m 11 příček	1
48411	3,8 m 13 příček	1

PLOŠINA PRACOVNÍ SKLÁDACÍ

ALU



· max. nosnost 150 kg

Č.p.	specifikace	
48420		1

TYČ ROZPÍNACÍ, PODPĚRNÁ

FESTA

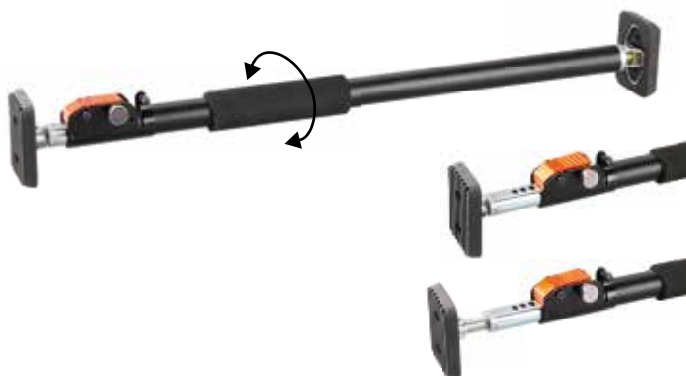

· max. nosnost 40 kg

Č.p.	specifikace	
52060	66 - 115 cm	1
52065	160 - 290 cm	1

ŽEBŘÍK TELESKOPICKÝ SKLÁDACÍ

ALU

CE EN
131

· max. nosnost 150 kg

Č.p.	specifikace	
48415	1,9 / 3,8 m 6/12 příček	1

STOJKA BEDNÍCÍ

MADE IN
EU

· 48449 klec na bednicí stojky

Č.p.	specifikace	
48452	160 - 290 cm	1
48453	180 - 320 cm	1
48454	200 - 360 cm	1
48455	250 - 440 cm	1
48456	260 - 380 cm	1
48457	220 - 400 cm	1

TYČ ROZPÍNACÍ, PODPĚRNÁ



Č.p.	specifikace	
52050	50 - 115 cm	1
52055	115 - 290 cm	1

VRUTY DO DŘEVA, BOX

310x



ks	obsah balení
60	3,0 x 12 mm
50	3,0 x 16 mm
40	3,0 x 20 mm
50	3,5 x 20 mm
40	3,5 x 30 mm
25	4,0 x 30 mm
20	4,0 x 40 mm
15	5,0 x 50 mm
10	5,0 x 60 mm



Č.p. specifikace
55642

1

VRUTY DO DŘEVA + HMOŽDINKY, BOX

170x



vruty do dřeva

ks	obsah balení
40	3,5 x 30 mm
25	4,0 x 40 mm
12	5,0 x 50 mm
8	6,0 x 60 mm

hmoždinky

ks	obsah balení
40	5 x 25 mm
25	6 x 30 mm
12	8 x 40 mm
8	10 x 50 mm



Č.p. specifikace
55645

1

VRUTY DO DŘEVA

2000x



ks	obsah balení
350	3,0 x 16 mm
280	3,0 x 20 mm
220	3,0 x 25 mm
250	3,5 x 20 mm
240	3,5 x 25 mm
180	3,5 x 3, mm
280	4,0 x 16 mm
80	4,0 x 30 mm
40	4,0 x 40 mm
30	4,0 x 50 mm
25	5,0 x 50 mm
25	5,0 x 60 mm



1

Č.p. specifikace
55640 2000 ks

DVÍŘKA KOMÍNOVÁ PLECHOVÁ



DVÍŘKA KOMÍNOVÁ KOMAX



DVÍŘKA KOMÍNOVÁ ZINKOVANÁ



Č.p. specifikace
65062



1

Č.p. specifikace
65063 šedá
65064 bílá



1

1

Č.p. specifikace
65065



1



294

WINLAND ZAHRADNICKÉ NŮŽKY



298

ZAHRADNICKÉ NŮŽKY



301

ZAHRADNÍ PILY



302

MAČETY A ZAHRADNICKÉ NÁŘADÍ



303

ZAHRADNICKÉ NÁŘADÍ



305

STRUNY DO SEKAČKY



306

BROUSKY

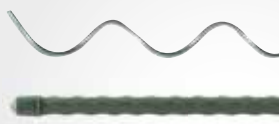

307

RAJČATOVÉ A ZAHRADNÍ TYČE



308

MULČOVACÍ TEXTILIE



310

ZAVLAŽOVÁNÍ AQUATIC, ROSA



322

VOZÍKY A DRŽÁKY NA HADICE



324

HADICOVÉ SPOJKY MOSAZ



326

HADICOVÉ SPOJKY



327

POSTŘIKOVAČE A KOMPRESORY



329

HRÁBĚ



334

RÝČE, LOPATY A VIDLE



340

MOTYKY A KRUMPÁČE



343

SMETÁKY



346

SHRNOVAČE SNĚHU



347

NÁSADY DŘEVĚNÉ, ALU A FIBERGLASS

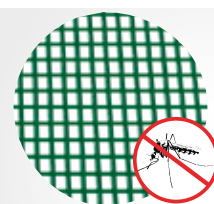

349

SÍTĚ PROTI HMYZU

ZAHRADNÍ NÁŘADÍ A PLETIVA

292 - 357



350

PLETIVA A VÁZACÍ DRÁTY



352

KOTEVNÍ PATKY A ZEMNÍ VRUTY

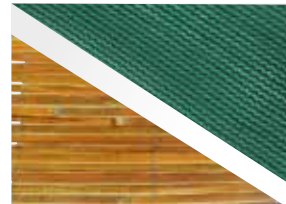

354

STÍNÍCÍ TKANINY, RÁKOS, BAMBUS



355

GRILOVACÍ NÁŘADÍ





ZAHRADNICKÉ NŮŽKY

- profesionální zahradní nůžky
- vysoká kvalita použitých materiálů
- kvalitní zpracování
- ergonomické rukojeti

ZAHRADNICKÉ NŮŽKY

SK5

- čepel HCS SK - 5, Japonská ocel



Č.p.	specifikace	
45020	205 mm	10
44980	Náhradní pružina	1

ZAHRADNICKÉ NŮŽKY

SK5

- čepel HCS SK - 5, Japonská ocel



Č.p.	specifikace	
45023	205 mm	10
44980	Náhradní pružina	1

ZAHRADNICKÉ NŮŽKY

SK5

- čepel HCS SK - 5, Japonská ocel



Č.p.	specifikace	
45063	215 mm	10
44981	Náhradní pružina	1

ZAHRADNICKÉ NŮŽKY

SK5

- čepel HCS SK - 5, Japonská ocel



Č.p.	specifikace	
44972	215 mm	10
44981	Náhradní pružina	1

ZAHRADNICKÉ NŮŽKY

SK5



Č.p.	specifikace	
45099	190 mm	10
44983	Náhradní pružina	1

ZAHRADNICKÉ NŮŽKY

SK5



Č.p.	specifikace	
45098	220 mm	10
44983	Náhradní pružina	1

ZAHRADNICKÉ NŮŽKY

SK5

TEFLON



Č.p.	specifikace	
45095	200 mm	10
44982	Náhradní pružina	1

ZAHRADNICKÉ NŮŽKY

SK5



- čepel HCS SK - 5, Japonská ocel
- nylonová rukojeť

Č.p.	specifikace	
45064	210 mm	10
44983	Náhradní pružina	1

ZAHRADNICKÉ NŮŽKY

SK5

TEFLON

- otočná rukojeť



- čepel HCS SK - 5, Japonská ocel

Č.p.	specifikace	
45096	220 mm	6
44982	Náhradní pružina	1

ZAHRADNICKÉ NŮŽKY

SK5

TEFLON



- čepel HCS SK - 5, Japonská ocel

Č.p.	specifikace	
45097	250 mm	10
44981	Náhradní pružina	1

ZAHRADNICKÉ NŮŽKY

INOX



Č.p.	specifikace	
45089	160 mm	10

ZAHRADNICKÉ NŮŽKY

INOX



Č.p.	specifikace	
45088	160 mm	10

ZAHRADNICKÉ NŮŽKY PRODLOUŽENÉ

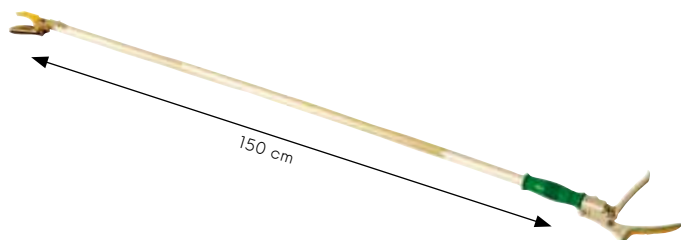

Č.p. specifikace
45017

10

NÁHRADNÍ BŘÍT



SK5

TEFLON



· pro nůžky 45095, 45027

Č.p. specifikace
45094

20

NŮŽKY NA VĚTVE



Ø max.
45mm

SK5

TEFLON



· čepel HCS SK - 5, Japonská ocel

Č.p. specifikace
44991 76 cm



12

NŮŽKY NA VĚTVE TELESKOPICKÉ



Ø max.
45mm

SK5

TEFLON



· čepel HCS SK - 5, Japonská ocel

Č.p. specifikace
44992 70 - 103 cm



10

NÁHRADNÍ PRUŽINA



Č.p.	pro nůžky	
44981	45021, 45025, 45063, 45097	1
44980	45020, 45023	1
44983	45098, 45099	1
44982	45027, 45095, 45096	1
44984	45110, 45014, 45026	1
44985	45018	1
44986	45019, 45029, 44970	1
44987	45021	1
44988	44971	1
44989	45015, 45016	1

NŮŽKY NA VĚTVE



NŮŽKY



TEFLON



Č.p. specifikace
44996 61 cm, vlnité ostří



12

NŮŽKY

TEFLON



Č.p.	specifikace	
44997	61 cm, rovné ostří	12

NŮŽKY NA TRÁVU OTOČNÉ 360°



Č.p.	specifikace	
44998		6

BROUSEK NA NŮŽKY A NOŽE 6 V 1



Č.p.	specifikace	
45068		10

BROUSEK NA NŮŽKY A NOŽE



Č.p.	specifikace	
45048		20

NŮŽKY

INOX



Č.p.	specifikace	
45010	190 mm	12
44984	Náhradní pružina	1

NŮŽKY

INOX



Č.p.	specifikace	
45014	190 mm	12
44984	Náhradní pružina	1

NŮŽKY

INOX



Č.p.	specifikace	
45026	150 mm	12
44985	Náhradní pružina	1

NŮŽKY ZAHRADNICKÉ



Č.p.	specifikace	
45018	210 mm kované	10

NŮŽKY ZAHRADNICKÉ

SK5

TEFLON



Č.p.	specifikace
45019	210 mm

Č.p.	specifikace
10	

NŮŽKY ZAHRADNICKÉ

FESTA

SK5

TEFLON

NYLON



· nylonová rukojeť

Č.p.	specifikace
45021	200 mm

Č.p.	specifikace
6	

NŮŽKY ZAHRADNICKÉ

ALU



Č.p.	specifikace
45025	200 mm

Č.p.	specifikace
12	

NŮŽKY ZAHRADNICKÉ

INOX



Č.p.	specifikace
44970	210 mm

Č.p.	specifikace
10	

NŮŽKY ZAHRADNICKÉ

TEFLON



Č.p.	specifikace
45027	200 mm

Č.p.	specifikace
10	

NŮŽKY ZAHRADNICKÉ

INOX

ALU



Č.p.	specifikace
45029	200 mm

Č.p.	specifikace
24	

NŮŽKY ZAHRADNICKÉ

INOX



Č.p.	specifikace
44971	160 mm

Č.p.	specifikace
10	

NŮŽKY ZAHRADNICKÉ



Č.p.	specifikace
45016	180 mm

Č.p.	specifikace
12	

NŮŽKY ZAHRADNICKÉ



Č.p. specifikace
45015 190 mm, rovné

12

POUZDRO NA ZAHRADNICKÉ NŮŽKY



Č.p. specifikace
37317

1

NŮŽKY NA TRÁVU



Č.p. specifikace
45011 300 mm

1

NŮŽKY NA TRÁVU OTOČNÉ



Č.p. specifikace
45012 370 mm, otočné 180°

1



NŮŽKY NA VĚTVE



• nylonová rukojeť

Č.p. specifikace
44999 540 mm, oblé

12

NŮŽKY NA VĚTVE

TEFLON

FESTA



Č.p. specifikace
45000 750 mm, oblé

6

NŮŽKY NA VĚTVE

TEFLON

FESTA



Č.p. specifikace
45001 710 mm, oblé

6

NŮŽKY NA VĚTVE

FESTA

TEFLON



Č.p. specifikace
45002 750 mm, ráčnové

12

NŮŽKY NA VĚTVE TELESKOPICKÉ

FESTA

TEFLON



Č.p. specifikace
45003 660-900 mm, teleskopické

6

NŮŽKY

TEFLON

 NYLON

Č.p. specifikace
44995 440 | 160 mm

12

NŮŽKY NA VĚTVE

FESTA

TEFLON



Č.p. specifikace
45005 580 | 230 mm, vlnité ostří

6

NŮŽKY



Č.p. specifikace
45009 500 | 190 mm, vlnité ostří

6

NŮŽKY

FESTA

TEFLON



Č.p. specifikace
45006 580 | 230 mm, rovné ostří

6

NŮŽKY



Č.p. specifikace
45008 500 | 190 mm, rovné ostří

6

NŮŽKY TELESKOPICKÉ

FESTA

TEFLON



Č.p. specifikace
45007 670-870 | 230 mm, vlnité ostří

6

PILA ZAVÍRACÍ



· 3 x broušené a kalené zuby



12

Č.p.	specifikace
45061	150 mm

PILA ZAVÍRACÍ



· 3 x broušené a kalené zuby



6

Č.p.	specifikace
45060	180 mm

PILA S POUZDREM



· 3 x broušené a kalené zuby



24

Č.p.	specifikace
45062	260 mm

PILA PROŘEZÁVACÍ



· 3 x broušené a kalené zuby



12

Č.p.	specifikace
24152	300 mm

PILA TELESKOPICKÁ PROŘEZÁVACÍ



· 3 x broušené a kalené zuby



1

Č.p.	specifikace
45033	230 - 490 cm 340 mm

HOUSENICE S PILKOU



Č.p.	specifikace		
45030	pilka 300 mm	teleskopická tyč 240 cm	6
45031	pilka 300 mm		6

HOUSENICE



Č.p.	specifikace	
45032	kovová housenice bez pilky	10



MAČETA

TEFLON



Č.p.	specifikace
45069	440 mm



MAČETA

TEFLON



Č.p.	specifikace
44950	490 mm



MAČETA NEREZ

INOX



Č.p.	specifikace
45083	430 mm
45084	600 mm



MAČETA



Č.p.	specifikace
45081	510 mm
45082	710 mm



rukojeť vyrobená z jasanového dřeva

LOPATKA ŠIROKÁ NEREZ

INOX



Č.p. 45056
specifikace 360 mm



LOPATKA ÚZKÁ NEREZ

INOX



Č.p. 45057
specifikace 350 mm



MOTYČKA NEREZ

INOX



Č.p. 45058
specifikace 270 mm



VYPICHOVAČ PLEVELE S KOLÉBKOU NEREZ

INOX



Č.p. 45059
specifikace 370 mm



LOPATKA ŠIROKÁ NYLON

NYLON



Č.p. 45065
specifikace 280 mm



LOPATKA ÚZKÁ NYLON

NYLON



Č.p. 45066
specifikace 310 mm



KULTIVÁTOR RUČNÍ NYLON

NYLON



Č.p. 45067
specifikace 290 mm



SADA NÁŘADÍ

HOBBY

4x



Č.p. 45035
specifikace 240 mm



KOLÍK SÁZECÍ "T"



Č.p.	specifikace
45038	280 mm



VYTRHÁVAČ PLEVELE



Č.p.	specifikace
44955	950 mm



NOŽ ZA KOROV



Č.p.	specifikace
45079	200 mm



NOŽ ZA KOROV



Č.p.	specifikace
45080	200 mm „L“



LOPATKA SKLÁDACÍ 3 V 1



pouzdro

Č.p.	specifikace
61085	410 mm



SAZEČ CIBULOVIN

INOX



Č.p.	specifikace
45040	230 mm



ČESÁČEK NA OVOCE



Č.p.	specifikace
45041	



ČESÁČEK NA OVOCE



Č.p.	specifikace
45039	
45034	170 - 300 cm, teleskopická násada





STRUNA DO SEKAČKY

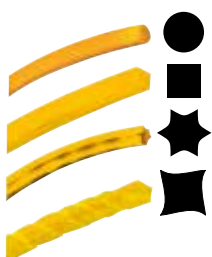

Č.p.	specifikace		
45500	1,3 mm x 15 m	●	30
45502	1,3 mm x 15 m	■	30
45503	1,6 mm x 15 m	★	20
45505	1,6 mm x 15 m	◆	20
45506	2 mm x 15 m	●	12
45508	2 mm x 15 m	■	12
45517	2 mm x 15 m	★	10
45509	2,4 mm x 15 m	◆	12
45511	2,4 mm x 15 m	●	12
45512	2,4 mm x 15 m	■	12
45518	2,4 mm x 15 m	★	10
45523	2,7 mm x 15 m	◆	10
45524	2,7 mm x 15 m	●	10
45513	3 mm x 15 m	■	10
45515	3 mm x 15 m	★	10
45516	3 mm x 15 m	◆	10
45519	3 mm x 15 m	●	10

STRUNA DO SEKAČKY S NYLONOVÝM STŘEDEM



Č.p.	specifikace		
45530	2 mm x 15 m	■	1
45531	2,4 mm x 15 m	■	1
45532	3 mm x 15 m	■	1
45533	3,15 mm x 15 m	■	1
45534	4 mm x 15 m	■	1

STRUNA DO SEKAČKY



Č.p.	specifikace		
45520	2 mm x 162 m	●	10
45521	2,4 mm x 112 m	●	10
45528	2,7 mm x 90 m	●	10
45522	3 mm x 72 m	●	10
45525	2 mm x 162 m	★	10
45526	2,4 mm x 112 m	★	10
45529	2,7 mm x 90 m	★	10
45527	3 mm x 72 m	★	10



BROUSEK NA KOSU



Č.p.	specifikace	
45046	205 x 15 mm	100

BROUSEK OVÁLNÝ



Č.p.	specifikace	
45370	250 x 33 x 18 mm	20

BROUSEK



Č.p.	specifikace	
45045	150 x 50 x 30 mm	50

BROUSEK NA NOŽE A NŮŽKY 6 V 1



Č.p.	specifikace	
45068		10

BROUSEK NA NOŽE A NŮŽKY



Č.p.	specifikace	
45048		20

BROUSEK NA NOŽE A NŮŽKY



Č.p.	specifikace	
16990	Ø 50 mm	50

BROUSEK NA NOŽE A NŮŽKY



Č.p.	specifikace	
16991		20

VÁZACÍ PÁSKY

3x



Č.p.	specifikace	
45472	3 cm x 3 m, 3 ks	36

VÁZACÍ PÁSKA



Č.p.	specifikace	
45473	3 cm x 50 m	60

VÁZACÍ PÁSKA, SUCHÝ ZIP



Č.p.	specifikace	
45471	12 mm x 5 m	1

DRÁT VÁZACÍ PVC

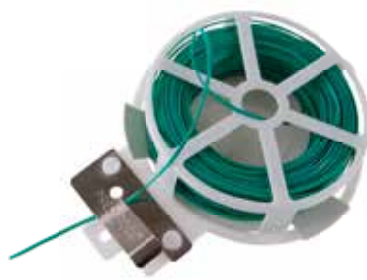

Č.p.	specifikace	
45043	30 m	30

DRÁT VÁZACÍ POGUMOVANÝ



Č.p.	specifikace	
23845	3 mm x 8 m	30
23846	4 mm x 6 m	30
23847	5 mm x 4 m	30

TYČ SKLOVLÁKNOVÁ



Č.p.	specifikace	
45036	180 cm Ø 7,9 mm	100

TYČ SPIRÁLOVÁ K RAJČATŮM



Č.p.	specifikace	
44041	1,2 m, Ø 5,5 mm komaxit - zelená	10
44042	1,5 m, Ø 6 mm komaxit - zelená	10
44043	1,8 m, Ø 6 mm komaxit - zelená	10
45049	1,8 m, Ø 7 mm komaxit - zelená	10
45044	1,8 m, Ø 7 mm komaxit - stříbrná	10
44050	2,2 m, Ø 7 mm komaxit - zelená	10

TYČ ZAHRADNÍ POPLASTOVANÁ



Č.p.	specifikace		Č.p.	specifikace		Č.p.	specifikace	
45650	90 cm Ø 8 mm	25	45655	150 cm Ø 11 mm	25	45659	180 cm Ø 16 mm	25
45651	120 cm Ø 8 mm	25	45656	180 cm Ø 11 mm	25	45660	210 cm Ø 16 mm	25
45652	150 cm Ø 8 mm	25	45661	210 cm Ø 11 mm	25	45662	150 cm Ø 20 mm	10
45653	90 cm Ø 11 mm	25	45657	120 cm Ø 16 mm	25	45663	180 cm Ø 20 mm	10
45654	120 cm Ø 11 mm	25	45658	150 cm Ø 16 mm	25	45664	210 cm Ø 20 mm	10



PÁSEK VÁZACÍ ZUBATÝ

50x



Č.p.	specifikace	
23840		20

SPOJKA PLASTOVÁ



Č.p.	specifikace	
45670	8 mm	10
45671	11 mm	10
45672	16 mm	10
45673	20 mm	10

SÍŤ NA OKURKY

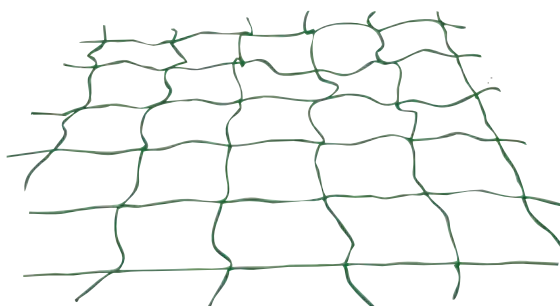

Č.p.	specifikace	velikost oka	
45560	2 x 10 m	10 x 10 cm	100

TEXTILIE NETKANÁ S VÝSEKY NA VÝSADBU JAHODNÍKU

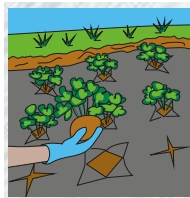
45 g/m²

Č.p.	specifikace	
45535	1,6 x 5 m	18

TEXTILIE NETKANÁ MULČOVACÍ ČERNÁ

50 g/m²

Č.p.	specifikace	
45550	1,6 x 5 m	50
45551	1,6 x 10 m	20
45564	3,2 x 10 m	20
45552	1,6 x 50 m	v roli 1
45553	1,6 x 100 m	v roli 1
45562	3,2 x 50 m	v roli 1
45563	3,2 x 100 m	v roli 1

TEXTILIE NETKANÁ MULČOVACÍ HNĚDÁ

50 g/m²

Č.p.	specifikace	
45556	1,6 x 5 m	50
45557	1,6 x 10 m	20
45565	3,2 x 10 m	20
45558	1,6 x 50 m	v roli 1
45559	1,6 x 100 m	v roli 1

TEXTILIE NETKANÁ BÍLÁ

17 g/m²

Č.p.	specifikace	
45540	1,6 x 5 m	40
45541	1,6 x 10 m	40
45542	1,6 x 50 m	v roli 1
45543	1,6 x 100 m	v roli 1

KOLÍK KOTVÍCÍ K UPEVNĚNÍ NETKANÉ TEXTILIE

10x



Č.p.	specifikace	
45555	11,5 cm	1

STOLIČKA ZAHRADNÍ, SKLÁDACÍ



• oboustranná - klekátko, sedátko

Č.p.	specifikace	
45074	58 x 48 x 28 cm	4

PODLOŽKA KLEKACÍ



Č.p.	specifikace	
45086	40 x 18 x 2 cm	50



KULTIVÁTOR



Č.p.	specifikace	
45042	160 x 132 cm	12

KULTIVÁTOR



Č.p.	specifikace	
44053		12
61251	160 cm násada	1

VOZÍK SYPACÍ

rozměry	
výška	111 cm
šířka	55 cm
objem zásobníku	12 l



Č.p.	specifikace	
45085	12 l	1

NÁDOBA PLAST - PRUŽNÁ



KOŠ NA LISTÍ, SKLÁDACÍ



Č.p.	specifikace	
39192	30 l	20
39193	45 l	20

Č.p.	specifikace	
45047	55 x 70 cm, 3 držadla	20

KOŠ SKLÁDACÍ

VAK NA LISTÍ



Č.p.	specifikace	
45093	40 x 25 x 23 cm	20

Č.p.	specifikace	
44960	200 l 60 x 60 x 55 cm	1

- PROFESIONÁLNÍ ZAVLAŽOVACÍ SORTIMENT
- KVALITNÍ MATERIÁLY A ZPRACOVÁNÍ
- MODERNÍ DESIGN
- KOMPATIBILNÍ S ŘADOU PRODUKTŮ ROSA

FESTA®
AQUATIC



PISTOLE



FESTA®
AQUATIC



- 7 funkcí
- přední spoušť s pojistkou
- snadná regulace průtoku

Č.p. specifikace

45386



12

PISTOLE



FESTA®
AQUATIC



- plynulá regulace proudu
- přední spoušť s pojistkou
- snadná regulace průtoku

Č.p. specifikace

45388



12

ROZSTŘIKOVAČ



FESTA®
AQUATIC



SADA S ROZSTŘIKOVAČEM



FESTA®
AQUATIC



- plynulá regulace proudu

Č.p. specifikace

45389



24

- plynulá regulace proudu

Č.p. specifikace

45385

4 ks



12

SPOJKA

FESTA
AQUATIC

1/2"



Č.p. specifikace

45390

24

SPOJKA

FESTA
AQUATIC

3/4"



Č.p. specifikace

45391

24

RYCHLOSPOJKA

FESTA
AQUATIC

1/2"



Č.p. specifikace

45392

24

RYCHLOSPOJKA

FESTA
AQUATIC

3/4"



Č.p. specifikace

45393

24

STOP RYCHLOSPOJKA

FESTA
AQUATIC

1/2"



Č.p. specifikace

45394

24

STOP RYCHLOSPOJKA

FESTA
AQUATIC

3/4"



Č.p. specifikace

45395

24

ADAPTÉR

FESTA
AQUATIC

1/2"

3/4"



Č.p. specifikace

45396

24

ADAPTÉR

FESTA
AQUATIC

3/4"

1"



Č.p. specifikace

45397

24

ZAVLAŽOVAČ



- 2bar min
4bar max
- Max
27L/min
- 318m²

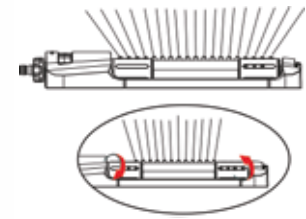

• 19 trysek, z toho 8 vypínatelných



Č.p. specifikace

45398



6

ZAVLAŽOVAČ



- 4bar max
- Max
30L/min
- 360°
- R 6m
113m²



• nastavitelná ramena s tryskami

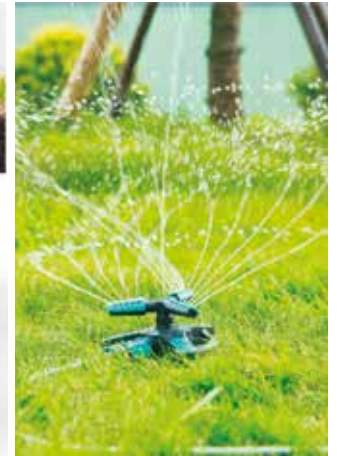

Č.p. specifikace

45399



12

ROZDĚLOVAČ



- 3/4"
- 1"



• plynulá regulace průtoku



Č.p. specifikace

45400 2 cestný



6

ROZDĚLOVAČ



- 3/4"
- 1"



• plynulá regulace průtoku



Č.p. specifikace

45401 4 cestný



6



ROSA

Watering system

PISTOLE



0,7 bar min
5,5 bar max



- 10 funkcí
- přední spoušť s pojistkou

Č.p. specifikace

45124



12

PISTOLE



0,7 bar min
5,5 bar max



- 10 funkcí
- spoušť s pojistkou
- snadná regulace průtoku

Č.p. specifikace

45125



12

PISTOLE



0,7 bar min
5,5 bar max



- 7 funkcí
- spoušť s pojistkou

Č.p. specifikace

45126



12

PISTOLE DELUX



0,7 bar min
5,5 bar max



- 7 funkcí
- spoušť s pojistkou
- snadná regulace průtoku

Č.p. specifikace

45123

kovová



12

PISTOLE



0,7 bar min
5,5 bar max



- 6 funkcí
- spoušť s pojistkou
- snadná regulace průtoku

Č.p. specifikace

45117



12

PISTOLE DELUX



0,7 bar min
5,5 bar max



- 6 funkcí
- spoušť s pojistkou
- snadná regulace průtoku

Č.p. specifikace

45118

kovová hlavice



12

PISTOLE

ROSA

0,7 bar min
5,5 bar max

- 5 funkcí
- spoušť s pojistkou
- snadná regulace průtoku



Č.p. specifikace

45110

12

PISTOLE

ROSA

0,7 bar min
5,5 bar max

- pistole růžicová
- snadná regulace průtoku



Č.p. specifikace

45116

12

PISTOLE

ROSA

0,7 bar min
5,5 bar max

- kovová hlavice
- spoušť s pojistkou
- snadná regulace průtoků



Č.p. specifikace

45120

12

PISTOLE

ROSA

0,7 bar min
5,5 bar max

- spoušť s pojistkou
- snadná regulace průtoku



Č.p. specifikace

45115

12

PISTOLE

ROSA

0,7 bar min
5,5 bar max

- kovová
- spoušť s pojistkou
- snadná regulace průtoku



Č.p. specifikace

45122 kovová

12

PISTOLE SADA

ROSA

0,7 bar min
5,5 bar max

1/2"

2x



- spoušť s pojistkou
- snadná regulace průtoku



Č.p. specifikace

45114 1/2 rychlospojka

12

PISTOLE

ROSA

0,7 bar min
5,5 bar max

- spoušť s pojistkou
- snadná regulace průtoku



Č.p. specifikace

45111

12

ROZSTŘIKOVAČ

ROSA

0,7 bar min
5,5 bar max

- plynulá regulace proudu



Č.p. specifikace

45113

60

ROZSTŘIKOVAČ

ROSA

0,7 bar min
5,5 bar max



· proudnicový, klasické připojení



Č.p. specifikace

45112



32

PISTOLE SADA

ROSA

0,7 bar min
5,5 bar max



4x



· 6 funkcí
· spoušť s pojistkou
· snadná regulace průtoku



Č.p. specifikace

45181



12

SOUPRAVA S ROZSTŘIKOVAČEM

ROSA

0,7 bar min
5,5 bar max



4x



· plynulá regulace proudu



Č.p. specifikace

45180



12

ROZDVOJKA - Y

ROSA

0,7 bar min
5,5 bar max



· s ventilem



Č.p. specifikace

45134



12

SPOJKA

ROSA

10 bar max



Č.p. specifikace

45140



60

SPOJKA

ROSA

10 bar max



MOQ 20



Č.p. specifikace

45296



MOQ 20

RYCHLOSPOJKA

ROSA

10 bar max



Č.p. specifikace

45142



60

RYCHLOSPOJKA

ROSA

10 bar max



MOQ 20



Č.p. specifikace

45298



MOQ 20

STOP RYCHLOSPOJKA

ROSA

10 bar max

1/2"



Č.p. specifikace

45138

60

STOP RYCHLOSPOJKA

ROSA

10 bar max

1/2"



MOQ 20



Č.p. specifikace

45294

MOQ 20

SPOJKA

ROSA

10 bar max

3/4"



Č.p. specifikace

45141

60

SPOJKA

ROSA

10 bar max

3/4"



MOQ 20



Č.p. specifikace

45297

MOQ 20

RYCHLOSPOJKA

ROSA

10 bar max

3/4"



Č.p. specifikace

45143

60

RYCHLOSPOJKA

ROSA

10 bar max

3/4"



MOQ 20



Č.p. specifikace

45299

MOQ 20

STOP RYCHLOSPOJKA

ROSA

10 bar max

3/4"



Č.p. specifikace

45139

60

STOP RYCHLOSPOJKA

ROSA

10 bar max

3/4"



MOQ 20



Č.p. specifikace

45295

MOQ 20

ADAPTÉR

ROSA

10 bar max



Č.p.	specifikace	
45130	1/2" + 3/4"	60
45131	3/4" + 1"	60

ADAPTÉR

ROSA

10 bar max



MOQ 20



Č.p.	specifikace	
45289	1/2" + 3/4"	MOQ 20
45290	3/4" + 1"	MOQ 20

RYCHLOSPOJKA SADA

ROSA

10 bar max



2x



Č.p.	specifikace	
45144		60

REDUKCE 1/2" - 3/4"

ROSA

10 bar max



Č.p.	specifikace	
45213	1/2" - 3/4"	60

SPOJOVACÍ VENTIL

ROSA

6,9 bar max



Č.p.	specifikace	
45135	s ventilem	60

ADAPTÉR

ROSA

10 bar max



Č.p.	specifikace	
45145		60

ADAPTÉR

ROSA

10 bar max



Č.p.	specifikace	
45132		60

ADAPTÉR

ROSA

10 bar max



MOQ 20



Č.p.	specifikace	
45291		MOQ 20

ADAPTÉR



ADAPTÉR



MOQ 20



Č.p. specifikace



45133

60

Č.p. specifikace



45292

MOQ 20

ADAPTÉR



ADAPTÉR



MOQ 20



Č.p. specifikace



45136

60

Č.p. specifikace



45293

MOQ 20

ADAPTÉR



ADAPTÉR



Č.p. specifikace

45137

60

Č.p. specifikace



45215

48

SPOJKA



RYCHLOSPOJKA



Č.p. specifikace

45218

48

Č.p. specifikace



45219

48

REDUKCE 3/4" - 1"

ROSA



Č.p. specifikace

45216

48

ADAPTÉR

ROSA



Č.p. specifikace

45217

48

PRODEJNÍ SADA

ROSA

225x



· obsah sady

45113	15 ks
45117	10 ks
45120	15 ks
45132	40 ks
45131	40 ks
45133	40 ks
45142	25 ks
45143	20 ks
45140	20 ks

Č.p. specifikace

45146

1

POSTŘIKOVACÍ HUBICE

ROSA



· plynulá regulace proudu

Č.p. specifikace

45214

48

ZAVLAŽOVAČ IMPULSNÍ

ROSA



· impulsní

Č.p. specifikace

45162

24

ZAVLAŽOVAČ

ROSA



· 8 funkcí

Č.p. specifikace

45154

48

ZAVLAŽOVAČ

ROSA



· rotační
· 2 ramena

Č.p. specifikace

45153

24

ZAVLAŽOVAČ

ROSA



· rotační
· 3 ramena

Č.p. specifikace

45152

24

ZAVLAŽOVAČ VÝKYVNÝ

ROSA

0,7 bar min
5,5 bar max

ALU



· 17 trysek

Č.p. specifikace

45158



6

ZAVLAŽOVAČ

ROSA

0,7 bar min
5,5 bar max

· pyramidový

Č.p. specifikace

45167



12

ZAVLAŽOVAČ

ROSA

0,7 bar min
5,5 bar max

· hrotový

Č.p. specifikace

45160



25

ZAVLAŽOVAČ

ROSA

0,7 bar min
5,5 bar max

· konvicový s ventilem

Č.p. specifikace

45156



12

PODSTAVEC PRO IMPULSNÍ ZAVLAŽOVAČ

ROSA

0,7 bar min
5,5 bar max

Č.p. specifikace

45155



24

ZAVLAŽOVAČ IMPULSNÍ

ROSA

0,7 bar min
5,5 bar max

· na trojnožce

Č.p. specifikace

45163 impulsní na trojnožce

20

ČASOVAČ

ROSA

0,7 bar min
5,5 bar max

· 0 - 120 min.

Č.p. specifikace

45147



24

ZAVLAŽOVAČ IMPULSNÍ

ROSA

0,7 bar min
5,5 bar max

· mosazný

Č.p. specifikace

45150



12

ZAVLAŽOVAČ IMPULSNÍ

ROSA

0,7 bar min
5,5 bar max

3/4"



Č.p. specifikace

45151

12

ZAVLAŽOVAČ IMPULSNÍ, HROTOVÝ

ROSA

0,7 bar min
5,5 bar max

3/4"



Č.p. specifikace

45168 plastový hrot
45169 kovový hrot

12
12

ZAVLAŽOVAČ IMPULSNÍ, HROTOVÝ

ROSA

0,7 bar min
5,5 bar max



Č.p. specifikace

45161 plastový hrot

20

ZAVLAŽOVAČ ROTAČNÍ, HROTOVÝ

ROSA

0,7 bar min
5,5 bar max

3/4"



- 3 ramena
- dvoucestný

Č.p. specifikace

45164 plastový hrot

12

HROTOVÝ PODSTAVEC

ROSA

Zn

3/4"



Č.p. specifikace

45159

12

HROTOVÝ PODSTAVEC

ROSA

3/4"



Č.p. specifikace

45179

12

VODIČ HADICE

ROSA



Č.p. specifikace

45186

48

ZAVLAŽOVAČ IMPULSNÍ

ROSA

1"



20

Č.p. specifikace

45185

ZAVLAŽOVAČ IMPULSNÍ

ROSA

3/4"



20

Č.p. specifikace

45184

SADA TĚSNĚNÍ

ROSA



· pro položky

45110, 45111, 45118,
45120, 45121, 45123,
45125, 45126, 45130,
45131, 45132, 45134,
45135, 45152, 45153,
45154, 45155, 45156,
45162, 45177, 45178,
45180, 45196, 45197,
45198

Č.p. specifikace
45175



TĚSNĚNÍ NA SPOJKY A KONEKTORY

ROSA

50x



Č.p. specifikace
45187



DRŽÁK NA HADICI

ROSA



Č.p. specifikace
45182 1/2" 40 m



NAVÍJEČ NA HADICI

ROSA

0,7 bar min
5,5 bar max

1/2"



Č.p. specifikace
45176



· včetně hadice 1/2" 20 m

VOZÍK NA HADICI KOVOVÝ

ROSA



Č.p. specifikace
45183 1/2" 60 m



VOZÍK NA HADICI

ROSA



Č.p. specifikace
45177 1/2" 60 m



DRŽÁK NA HADICI

ROSA



Č.p. specifikace
45178 1/2" 60 m



SPRCHA

ROSA

0,7 bar min
5,5 bar max



Č.p. specifikace
45171 stavitelná

12

SPRCHA

ROSA

0,7 bar min
5,5 bar max



Č.p. specifikace
45170 3 nohy

6

SPRCHA - RUČNÍ

ROSA

0,7 bar min
5,5 bar max



Č.p. specifikace
45172 s ventilem
45173 10 funkcí

12
12

DRŽÁK HADIC

ROSA



Č.p. specifikace
45174

60

HADICE ZAHRADNÍ PRŮHLEDNÁ



Č.p. specifikace
45345 1/2" 25 m
45349 3/4" 25 m
45353 1" 25 m

1
1
1

HADICE ZAHRADNÍ NEPRŮHLEDNÁ



Č.p. specifikace
45360 1/2" 25 m
45364 3/4" 25 m
45366 1" 25 m

1
1
1

SPIRÁLOVÁ HADICE - SADA

ROSA

0,7 bar min
5,5 bar max



Č.p. specifikace
45300 7,5 m
45301 15 m

6
8

NOSIČ HADIC

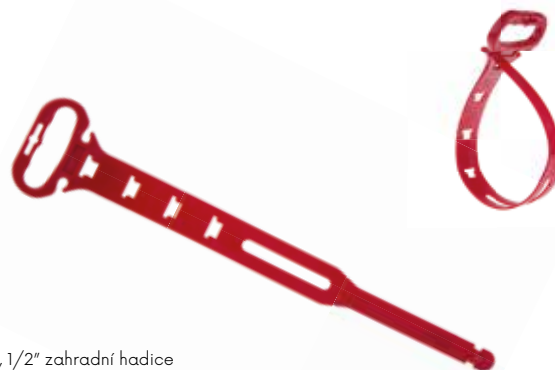

· max. 30 m, 1/2" zahradní hadice

Č.p. specifikace
45350 Max. nosnost 20 kg

1

SPOJKA MOSAZ

ROSA

0,7 bar min
13,8 bar max

1/2"



Č.p. specifikace

45192

48

RYCHLOSPOJKA MOSAZ

ROSA

0,7 bar min
13,8 bar max

1/2"



Č.p. specifikace

45194

48

STOP RYCHLOSPOJKA MOSAZ

ROSA

0,7 bar min
13,8 bar max

1/2"



Č.p. specifikace

45190

48

SPOJKA MOSAZ

ROSA

0,7 bar min
13,8 bar max

3/4"



Č.p. specifikace

45193

48

RYCHLOSPOJKA MOSAZ

ROSA

0,7 bar min
13,8 bar max

3/4"



Č.p. specifikace

45195

48

STOP RYCHLOSPOJKA MOSAZ

ROSA

0,7 bar min
13,8 bar max

3/4"



Č.p. specifikace

45191

48

ADAPTÉR MOSAZ

ROSA

0,7 bar min
13,8 bar max1/2"
3/4"

Č.p. specifikace

45196 s vnitřním závitem 1/2" + 3/4"

48

ADAPTÉR MOSAZ

ROSA

0,7 bar min
13,8 bar max

3/4"



Č.p. specifikace

45197 s vnitřním závitem 3/4"

48

ADAPTÉR MOSAZ

ROSA

0,7 bar min
13,8 bar max

1"



Č.p. specifikace

45199 s vnitřním závitem 1"

48

ADAPTÉR MOSAZ

ROSA

0,7 bar min
13,8 bar max3/4"
1"

Č.p. specifikace

45198 s vnitřním závitem 3/4 + 1"

48

ADAPTÉR MOSAZ

ROSA

0,7 bar min
13,8 bar max

3/4"



Č.p. specifikace

45200 s vnějším závitem 3/4"

48

POSTŘIKOVACÍ HUBICE MOSAZ

ROSA

0,7 bar min
13,8 bar max

Č.p. specifikace

45206 stavitelná

48

ADAPTÉR MOSAZ

ROSA



Č.p.	specifikace	
45203	mezikus pro 2 rychlospojky	48

ADAPTÉR MOSAZ

ROSA



Č.p.	specifikace	
45204	mezikus pro 3 rychlospojky	48

ADAPTÉR

MADE IN EU



Č.p.	specifikace	
45211	vnitřní závit 1"	25

HADICOVÁ SPOJKA



Č.p.	specifikace	
45220	1/2" závit 3/4"	10
45221	3/4" závit 1"	10
45222	1" závit 1"	10

HADICOVÁ KONCOVKA



Č.p.	specifikace	
45223	1/2" závit 3/4"	10
45224	3/4" závit 1"	10
45225	1" závit 1"	10

HADICOVÁ REDUKCE



Č.p.	specifikace	
45226	1/2" - 3/4" závit 1"	10
45227	1" - 3/4" závit 1"	10
45228	1" - 1/2" závit 1"	10

ROZPRAŠOVAČ



Č.p.	specifikace	
45229		10

SPONA HADICOVÁ

Zn



Č.p.	průměr	
45600	8 - 12 mm	100
45601	10 - 16 mm	100
45602	12 - 20 mm	100

Č.p.	průměr	
45603	16 - 25 mm	100
45604	20 - 32 mm	100
45605	25 - 40 mm	100
45606	30 - 45 mm	100
45607	32 - 50 mm	100
45608	40 - 60 mm	100
45609	50 - 70 mm	100
45610	60 - 80 mm	50
45611	70 - 90 mm	50
45612	80 - 100 mm	50
45613	90 - 110 mm	50
45614	100 - 120 mm	50
45615	110 - 130 mm	50
45616	120 - 140 mm	50
45617	130 - 150 mm	50
45618	140 - 160 mm	50
45619	150 - 170 mm	50

SPONA HADICOVÁ

INOX



Č.p.	průměr	šířka	
45620	8 - 12 mm	9 mm	100
45621	10 - 16 mm	9 mm	100
45622	12 - 20 mm	9 mm	100

Č.p.	průměr	šířka	
45623	16 - 25 mm	9 mm	100
45624	20 - 32 mm	9 mm	100
45625	25 - 40 mm	12 mm	100
45626	30 - 45 mm	12 mm	100
45627	32 - 50 mm	12 mm	100
45628	40 - 60 mm	12 mm	100
45629	50 - 70 mm	12 mm	100
45630	60 - 80 mm	12 mm	100
45631	70 - 90 mm	12 mm	100
45632	80 - 100 mm	12 mm	50
45633	90 - 110 mm	12 mm	50
45634	100 - 120 mm	12 mm	50
45635	110 - 130 mm	12 mm	50
45636	120 - 140 mm	12 mm	50
45637	130 - 150 mm	12 mm	50
45638	140 - 160 mm	12 mm	50
45639	150 - 170 mm	12 mm	50



VENTILY A ZAVLAŽOVACÍ KONVE

VENTIL ZAHRADNÍ DVOJITÝ



Č.p.	specifikace	
45105		8

VENTIL ZAHRADNÍ



Č.p.	specifikace	
45100	1/2"	12
45101	3/4"	10
45102	1"	6

VENTIL KULOVÝ



Č.p.	specifikace	
45106	1/2"	12
45107	3/4"	10
45108	1"	8

ROHÁČEK



Č.p.	specifikace	
45104	1/2" x 3/8"	10

KONEV PLASTOVÁ



Č.p.	specifikace	
45280	2,5 l	10
45283	5 l	10
45285	10 l	10
45286	12 l	10
45287	15 l	10





POSTŘIKOVAČ TLAKOVÝ ZAHRADNÍ 12 L



max. tlak	2,5 Bar
objem	12 l
délka hadice	3 m
rozměry	32 x 25 x 59 cm

Č.p.	specifikace	
45249	postřikovač tlakový zahradní 12 l	1
45273	pistole náhradní	1
45274	tlaková hadice náhradní	1

ČISTIČ VYSOKOTLAKÝ



napětí/ frekvence	230 V/50 Hz
příkon	1500 W
maximální tlak	120 Bar
pracovní tlak	80 Bar
průtok vody	6 l
délka hadice	5 m
krytí	IPX5
funkce	Auto Stop

Č.p.	specifikace	
45270	čistič vysokotlaký	1
45271	pistole náhradní	1
45272	tlaková hadice náhradní	1

POSTŘIKOVAČ TLAKOVÝ ZAHRADNÍ



Č.p.	specifikace	
45247	12 l	1
45248	16 l	1

Č.p.	specifikace	
45263	náhradní hadička k postřikovači	1
45251	náhradní sada těsnění	1
45254	náhradní tryska	1
45257	náhradní rukojeť	1
45260	náhradní tyč - 370 mm	1
45267	náhradní tyč 45 - 250 cm	1
45268	náhradní tyč 65 - 260 cm	1

POSTŘIKOVAČ TLAKOVÝ ZAHRADNÍ



Č.p.	specifikace	
45244	3 l	6
45245	5 l	6
45246	8 l	6

Č.p.	specifikace	
45262	náhradní hadička k postřikovači	1
45250	náhradní sada těsnění	1
45253	náhradní tryska	1
45256	náhradní rukojeť	1
45261	náhradní tyč - 370 mm	1

POSTŘIKOVAČ RUČNÍ TLAKOVÝ

FESTA



Č.p.	typ	
45242	1,5 l	20
45241	2 l	20

POSTŘIKOVAČ RUČNÍ

MADE IN EU



Č.p.	typ	
45239	0,5 l	1
45240	0,7 l	1

TYČ K POSTŘIKOVAČI TELESKOPICKÁ

· pro postřikovače 45244, 45245, 45246

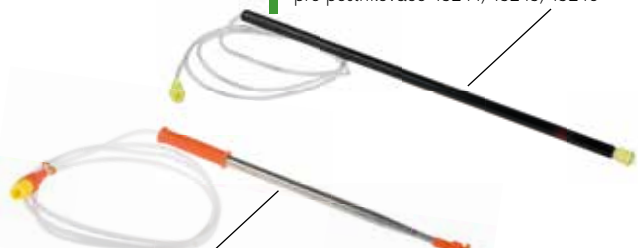

· pro postřikovače 45247, 45248

Č.p.	typ	
45267	45 - 250 cm inox	1
45268	65 - 260 cm fiberglass	1

TYČ K POSTŘIKOVAČI TELESKOPICKÁ

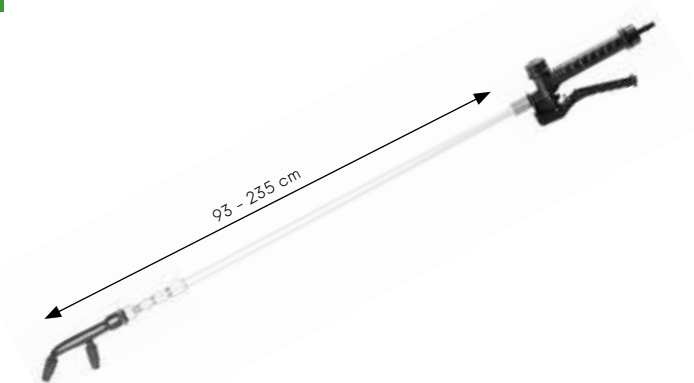

Č.p.	specifikace	
45269		1

NÁHRADNÍ HADIČKA K POSTŘIKOVAČI



Č.p.	typ	
45263	pro postřikovač 45247, 45248	1
45262	pro postřikovač 45244, 45245, 45246	1

ZVON HERBICIDNÍ



· pro postřikovače 45247, 45248, 45249

Č.p.	velikost	délka	šířka	výška	
45265	malý	230 mm	90 mm	130 mm	1
45266	velký	370 mm	140 mm	200 mm	1

ČERPADLO PONORNÉ



příkon	400 W
napětí	230 V 50 Hz
typ ochrany	IPX 8
max. výtlač (výška)	5 m
max. průtok	8000 l h
velikost zrna	3,5 mm
max. hloubka ponoru	7 m
max. teplota kapaliny	35°C
připojení	1", G1", 1/4", G1/2"
délka kabelu	10 m



Č.p.	výkon	
35350	400 W	1

FESTA®



HRÁBĚ

HRÁBĚ PLASTOVÉ



Č.p.	počet lamel	šířka	výška	
45327	13	240 mm	200 mm	12

SET HRÁBĚ PLASTOVÉ, HLINÍKOVÁ NÁSADA



Č.p.	počet lamel	délka násady	
61136	13	160 cm	3
61147	13	100 cm	3

HRÁBĚ PLASTOVÉ



Č.p.	počet lamel	šířka	výška	
45328	23	480 mm	280 mm	12

SET HRÁBĚ PLASTOVÉ, HLINÍKOVÁ NÁSADA



Č.p.	počet lamel	délka násady	
61137	23	160 cm	3
61148	23	100 cm	3

HRÁBĚ PLASTOVÉ



Č.p.	počet lamel	šířka	výška	
45329	35	760 mm	310 mm	1

SET HRÁBĚ PLASTOVÉ, HLINÍKOVÁ NÁSADA



Č.p.	počet lamel	délka násady	
61138	35	160 cm	3

HRÁBĚ PLASTOVÉ

FESTA



Č.p.	počet lamel	šířka	
45325	12	410 mm	12

SET HRÁBĚ PLASTOVÉ, HLINÍKOVÁ NÁSADA

FESTA



Č.p.	počet lamel	délka násady	
61139	12	160 cm	3

MOQ
3

HRÁBĚ PLASTOVÉ

FESTA



Č.p.	počet lamel	šířka	
45326	18	580 mm	12

SET HRÁBĚ PLASTOVÉ, HLINÍKOVÁ NÁSADA

FESTA



Č.p.	počet lamel	délka násady	
61140	18	160 cm	3

MOQ
3

ULICOVÝ SMETÁK



Č.p.	specifikace	
45323	37 cm	16

SET ULICOVÝ SMETÁK, NÁSADA



Č.p.	specifikace	délka násady	
61149	37 cm	160 cm (45330)	3

MOQ
3

HRÁBĚ KOVOVÉ STAVITELNÉ, TELESKOPICKÉ

FESTA

Zn



Č.p.	počet lamel	rozsah	
44965	15	200 - 590 mm	12

HRÁBĚ KOVOVÉ STAVITELNÉ

FESTA

Zn



Č.p.	počet lamel	váha	rozsah	
45050	15	1200 g	200 - 590 mm	25

HRÁBĚ KOVOVÉ LAMELOVÉ

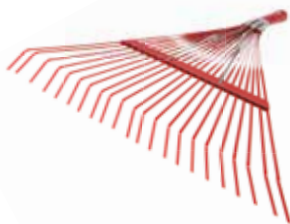

• pružinová ocel

Č.p.	šířka	počet lamel	
45071	56 cm	22	1

HRÁBĚ KOVOVÉ LAMELOVÉ, S NÁSADOU



MOQ
3

Č.p.	šířka	délka násady	
61150	56 cm	160 cm	3

HRÁBĚ KOVOVÉ LAMELOVÉ



Č.p.	šířka	počet lamel	
45051	45 cm	22	60

HRÁBĚ KOVOVÉ LAMELOVÉ, S NÁSADOU



MOQ
3

Č.p.	šířka	délka násady	
61130	45 cm	160 cm	3

HRÁBĚ KOVOVÉ DRÁTOVÉ



Č.p.	šířka	počet lamel	
45052	45 cm	22	36

HRÁBĚ KOVOVÉ S NÁSADOU



MOQ
3

Č.p.	šířka	délka násady	
61131	45 cm	160 cm	3

HRÁBĚ PLASTOVÉ



Č.p.	šířka	počet lamel	
45320	60 cm	24	10

HRÁBĚ PLASTOVÉ S NÁSADOU



MOQ
3

Č.p.	šířka	počet lamel	délka násady	
61132	60 cm	24	160 cm	3

HRÁBĚ PLASTOVÉ



Č.p.	šířka	počet lamel	
45055	50 cm	22	10

HRÁBĚ PLASTOVÉ S NÁSADOU



MOQ
3

Č.p.	šířka	počet lamel	délka násady	
61133	50 cm	22	160 cm	3

HRÁBĚ PLASTOVÉ



Č.p.	šířka	počet lamel	
45321	40 cm	23	20

HRÁBĚ PLASTOVÉ S NÁSADOU

MOQ
3

Č.p.	počet lamel	délka násady	
61134	23	160 cm	3

HRÁBĚ PLASTOVÉ



Č.p.	šířka	počet lamel	
45054	40 cm	23	10

HRÁBĚ PLASTOVÉ S NÁSADOU

MOQ
3

Č.p.	šířka	počet lamel	délka násady	
61135	40 cm	23	160 cm	3

HRÁBĚ PLASTOVÉ



Č.p.	šířka	počet lamel	
45053	58 cm	16	35

HRÁBĚ PLASTOVÉ S NÁSADOU

MOQ
3

Č.p.	šířka	počet lamel	délka násady	
61141	58 cm	16	160 cm	3

HRÁBĚ PLASTOVÉ, SE ZAROVNÁVACÍ HRANOU



Č.p.	šířka	počet zubů	
45070	41 cm	14	4

HRÁBĚ PLASTOVÉ, SE ZAROVNÁVACÍ HRANOU, S NÁSADOU

MOQ
3

Č.p.	šířka	počet zubů	délka násady	
61142	41 cm	14	160 cm	3

HRÁBĚ KOVOVÉ



Č.p.	šířka	počet zubů	
61030	24 cm	10	24
61031	29 cm	12	24
61032	34 cm	14	24
61033	40 cm	16	24

HRÁBĚ KOVOVÉ S NÁSADOU



MOQ
3

Č.p.	šířka	počet zubů	délka násady	
61060	24 cm	10	160 cm	3
61061	29 cm	12	160 cm	3
61062	34 cm	14	160 cm	3
61063	40 cm	16	160 cm	3

HRÁBĚ VERTIKUTAČNÍ KOVOVÉ



· kladivkový lak

Č.p.	šířka	počet zubů	
61045	30 cm	12	25
61046	39 cm	14	25
61047	45 cm	16	25

HRÁBĚ VERTIKUTAČNÍ S NÁSADOU



· kladivkový lak

MOQ
3

Č.p.	šířka	počet zubů	délka násady	
61143	30 cm	12	160 cm	3
61144	39 cm	14	160 cm	3
61145	45 cm	16	160 cm	3

HRÁBĚ VERTIKUTAČNÍ



Č.p.	šířka	počet zubů	
61048	35 cm	11 21	12

HRÁBĚ VERTIKUTAČNÍ S NÁSADOU



MOQ
3

Č.p.	šířka	počet zubů	délka násady	
61146	35 cm	11 21	160 cm	3



HRÁBĚ KOVOVÉ S NÁSADOU, FIBERGLASS



MOQ
3

Č.p.	šířka	počet zubů	délka násady	
61034	34 cm	14	160 cm	3

RÝČE
A
LOPATY
FESTA®

RÝČ ŠPIČATÝ MALÝ

FESTA®

• vhodný pro práci ve skleníku

Č.p.	specifikace	délka násady	
61008	19 x 28 cm	85 cm	5

RÝČ OBLÝ

FESTA®

Č.p.	specifikace	délka násady	
61005	20 x 29 cm	120 cm	5

RÝČ ŠPIČATÝ

FESTA®

Č.p.	specifikace	délka násady	
61006	19 x 28 cm	120 cm	5

RÝČ OBLÝ, PRODLOUŽENÝ

FESTA®

• pro postavy vyšší 180 cm

Č.p.	specifikace	délka násady	
61157	20 x 29 cm	130 cm	5

RÝČ ŠPIČATÝ, PRODLOUŽENÝ

FESTA®

• pro postavy vyšší 180 cm

Č.p.	specifikace	délka násady	
61158	19 x 28 cm	130 cm	5

LOPATA STANDARD

FESTA®

Č.p.	specifikace	délka násady	
61155	24 x 29 cm	120 cm	5

VIDLE

FESTA®

Č.p.	specifikace	délka násady	
61156	19 x 28 cm	130 cm	5

RYCÍ VIDLE

RYCÍ VIDLE, NÁSADA FIBERGLASS



Č.p.	specifikace	délka násady	
61007	18 x 28 cm	130 cm	5

Č.p.	specifikace	délka násady	
61010	18 x 30 cm	95 cm	12

RYČ ŠPIČATÝ, NÁSADA FIBERGLASS

RYČ OBLÝ, NÁSADA FIBERGLASS



Č.p.	specifikace	délka násady	
61029	19 x 30 cm	95 cm	12

Č.p.	specifikace	délka násady	
61015	19 x 30 cm	95 cm	12

LOPATA HLINÍKOVÁ



LOPATA HLINÍKOVÁ S NÁSADOU



ALU

ALU



· buková násada kolínko

Č.p.	specifikace	
61026	26 x 29 cm	10
61025	34 x 30 cm	10

Č.p.	specifikace	délka násady	
61057	26 x 29 cm	130 cm	3
61056	34 x 30 cm	130 cm	3

MOQ
3

LOPATA UHELNÁ

LOPATA UHELNÁ S NÁSADOU



Č.p.	specifikace	
61021	35 x 35 cm	10

Č.p.	specifikace	délka násady	
61089	35 x 35 cm	130 cm	3

MOQ
3

LOPATA SRDCOVKA S NÁSADOU



- kladivkový lak
- buková násada kolínko

MOQ
3

Č.p.	specifikace	délka násady
61050	26 x 28 cm	130 cm



LOPATA SRDCOVKA



- kladivkový lak

Č.p.	specifikace
61000	26 x 28 cm



LOPATA SRDCOVKA S NÁSADOU



- buková násada kolínko

MOQ
3

Č.p.	specifikace	délka násady
61088	26 x 28 cm	130 cm



LOPATA SRDCOVKA



Č.p.	specifikace
61020	26 x 28 cm



LOPATA STANDARD S NÁSADOU



- kladivkový lak
- buková násada kolínko

MOQ
3

Č.p.	specifikace	délka násady
61051	24 x 29 cm	130 cm



LOPATA STANDARD



- kladivkový lak

Č.p.	specifikace
61001	24 x 29 cm



LOPATA STANDARD S NÁSADOU



- buková násada kolínko

MOQ
3

Č.p.	specifikace	délka násady
61090	24 x 29 cm	130 cm
61053	24 x 29 cm	130 cm "T _n " násada



LOPATA STANDARD



Č.p.	specifikace
61022	24 x 29 cm





LOPATA HOLŠTÝNSKÁ



Č.p.	specifikace	
61058	25 x 27 cm	12

LOPATA ÚZKÁ



- kladivkový lak

Č.p.	specifikace	
61002	19 x 27 cm	12

LOPATA ÚZKÁ



Č.p.	specifikace	
61024	19 x 27 cm	12

RÝČ ŠPIČATÝ



- kladivkový lak

Č.p.	specifikace	
61004	22 x 30 cm	12

LOPATA HOLŠTÝNSKÁ S NÁSADOU



- buková násada kolínko

MOQ
3

Č.p.	specifikace	délka násady	
61059	25 x 27 cm	130 cm	3

LOPATA ÚZKÁ S NÁSADOU



- kladivkový lak
- buková násada kolínko

MOQ
3

Č.p.	specifikace	délka násady	
61052	19 x 27 cm	130 cm	3

LOPATA ÚZKÁ S NÁSADOU



- buková násada kolínko

MOQ
3

Č.p.	specifikace	délka násady	
61054	19 x 27 cm	130 cm	3

RÝČ ŠPIČATÝ S "T," NÁSADOU



- kladivkový lak

MOQ
3

Č.p.	specifikace	délka násady	
61161	22 x 30 cm	90 cm	3

RÝČ ŠPIČATÝ S "T,, NÁSADOU

MOQ
3

Č.p.	specifikace	délka násady	
61097	19 x 30 cm	90 cm	3

RÝČ ŠPIČATÝ



Č.p.	specifikace	
61019	22 x 30 cm	12

RÝČ KOVANÝ, ŠPIČATÝ, S "T,, NÁSADOU

MOQ
3

Č.p.	specifikace	délka násady	
61162	22 x 25 cm	90 cm	3
61223	násada	90 cm	1

RÝČ KOVANÝ, ŠPIČATÝ



Č.p.	specifikace	
61013	22 x 25 cm	12

RÝČ OBLÝ S "T,, NÁSADOU

MOQ
3

Č.p.	specifikace	délka násady	
61163	21 x 30 cm	90 cm	3

• kladivkový lak

RÝČ OBLÝ



• kladivkový lak

Č.p.	specifikace	
61003	21 x 30 cm	12

RÝČ OBLÝ S "T,, NÁSADOU

MOQ
3

Č.p.	specifikace	délka násady	
61098	21 x 30 cm	90 cm	3

RÝČ OBLÝ



Č.p.	specifikace	
61018	21 x 30 cm	12



RÝČ ŠTYCHAR



Č.p.	specifikace	
61014	14 x 37 cm	12

RÝČ ŠTYCHAR S "T,, NÁSADOU



Č.p.	specifikace	délka násady	
61164	14 x 37 cm	90 cm	MOQ 3
61203	násada	90 cm	1

VIDLE NA SENO



Č.p.	specifikace	
61009	20 x 32 cm	12

VIDLE NA SENO S NÁSADOU



· buková násada kolínko

MOQ 3

Č.p.	specifikace	délka násady	
61165	20 x 32 cm	90 cm	3

VIDLE RYČÍ KOVANÉ



Č.p.	specifikace	
61012	22 x 30 cm	12

VIDLE RYČÍ KOVANÉ S "T,, NÁSADOU



Č.p.	specifikace	délka násady	
61166	22 x 30 cm	90 cm	MOQ 3
61222	násada	90 cm	1

RYČÍ VIDLE



Č.p.	specifikace	
61044	20 x 30 cm	12

VIDLE RYČÍ S "T,, NÁSADOU



Č.p.	specifikace	délka násady	
61028	20 x 30 cm	90 cm	MOQ 3
61209	násada	90 cm	1

MOTYKA KOVANÁ, ŠPIČATÁ, S NÁSADOU



Č.p.	specifikace	délka násady	
61111	0,4 kg	120 cm	MOQ 3
61112	0,6 kg	120 cm	MOQ 3
61224	násada	120 cm	1

MOTYKA PLOCHÁ, KOVANÁ, S NÁSADOU



Č.p.	specifikace	délka násady	
61114	0,6 kg	120 cm	MOQ 3
61224	násada	120 cm	1

KRUMPÁČ KOVANÝ S NÁSADOU



Č.p.	specifikace	délka násady	
61121	1,5 kg	95 cm	3
61042	2,5 kg	95 cm	3

MOQ
3

MOTYKA KOVANÁ, ŠPIČATÁ

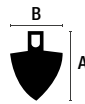

Č.p.	specifikace	A	B	
61035	0,4 kg	180 mm	125 mm	1
61036	0,6 kg	230 mm	160 mm	30

MOTYKA KOVANÁ, PLOCHÁ

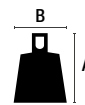

Č.p.	specifikace	A	B	
61038	0,6 kg	165 mm	135 mm	20

KRUMPÁČ KOVANÝ



Č.p.	specifikace	
61120	1,5 kg	6
61040	2,5 kg	6



MOTYKA



Č.p.	specifikace	
61067	75 mm	1
61068	125 mm	1
61069	175 mm	1

MOTYKA S NÁSADOU



MOQ
3

Č.p.	specifikace	délka násady	
61290	75 mm	120 cm	3
61291	125 mm	120 cm	3
61292	175 mm	120 cm	3

MOTYKA SRDCOVÁ



Č.p.	specifikace	
61070	140 mm	40

MOTYKA SRDCOVÁ S NÁSADOU



MOQ
3

Č.p.	specifikace	délka násady	
61293	140 mm	120 cm	3

MOTYKA PLOCHÁ S NÁSADOU



Č.p.	specifikace	délka násady	
61294	140 mm	27 cm	MOQ 3
61221	násada	27 cm	1

MOTYKA SRDCOVÁ S NÁSADOU



Č.p.	specifikace	délka násady	
61295	140 mm	27 cm	MOQ 3
61221	násada	27 cm	1

MOTYKA PLEČKA S NÁSADOU



Č.p.	specifikace	délka násady	
61296	175 mm	27 cm	MOQ 3
61221	násada	27 cm	1

DRÁBEK SE 3 HROTY S NÁSADOU



Č.p.	specifikace	délka násady	
61297		27 cm	MOQ 3
61221	násada	27 cm	1

REKLAMNÍ STOJAN NA LOPATY A RÝČE

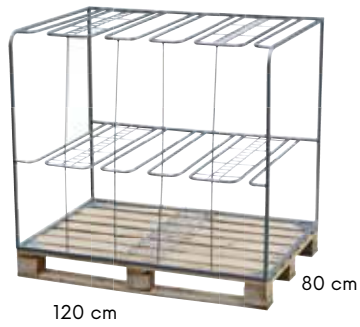

120 cm

80 cm



• ilustrační foto

Č.p.	specifikace	
61077	stojan osazený	1
61079	stojan s paletou	1

DRŽÁK ZAHRADNÍHO NÁŘADÍ



• ilustrační foto



Č.p.	specifikace	
51185	45 cm	5

DRŽÁK ZAHRADNÍHO NÁŘADÍ

5x



• otočné gumové válečky

Č.p.	specifikace	
51184		12

SRP



Č.p.	specifikace	
45490	450 mm	1

KARTÁČ OCELOVÝ

FESTA



Č.p.	specifikace		
22135	6 x 19 cm	bez násady	8
22137	6 x 19 cm	s násadou 140 cm	MOQ 3

KARTÁČ NYLONOVÝ

FESTA



Č.p.	specifikace		
22136	6 x 19 cm	bez násady	8
22138	6 x 19 cm	s násadou 140 cm	MOQ 3

KARTÁČ OCELOVÝ NA ČIŠTĚNÍ SPÁR S NÁSADOU



Č.p.	délka násady		
52198	140 cm		1

SMETÁČEK

MADE IN EU



Č.p.	specifikace		
52119	29 cm		24

SMETÁČEK S LOPATKOU

MADE IN EU



Č.p.	specifikace		
52168			26

SMETÁČEK S LOPATKOU

MADE IN EU



Č.p.	specifikace		
52173			26

LOPATKA PLECHOVÁ - ZESÍLENÁ

FESTA



Č.p.	specifikace		
52176	22 x 23 cm		24

LOPATKA PLECHOVÁ

Zn

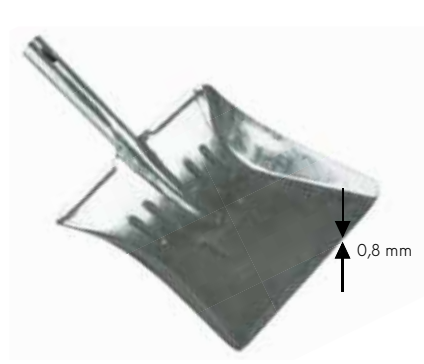

Č.p.	specifikace		
52175	22 x 23 cm		50

ULICOVÝ SMETÁK S NÁSADOU

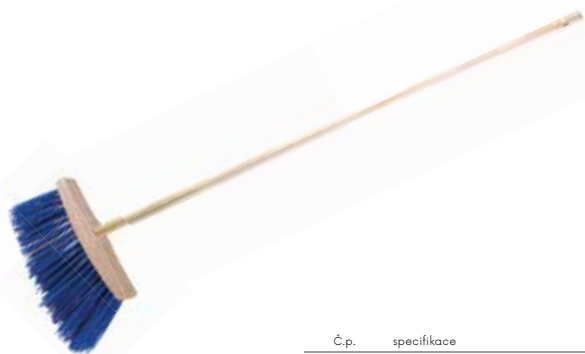

MOQ
3

Č.p.	specifikace			
52197	30 cm 120 cm dřevěná	3		

ULICOVÝ SMETÁK



Č.p.	specifikace		
52108	30 cm hrubý závit	25	
61172	násada 120 cm hrubý závit	1	

SET ULICOVÝ SMETÁK, NÁSADA



MOQ
3

Č.p.	specifikace	délka násady	
61149	37 cm	160 cm	3

ULICOVÝ SMETÁK



Č.p.	specifikace	
45323	37 cm	16

ULICOVÝ SMETÁK S NÁSADOU



MOQ
3

Č.p.	specifikace	délka násady	
52190	30 cm	150 cm	3
52191	40 cm	150 cm	3
52192	50 cm	150 cm	3
52193	60 cm	150 cm	3
52194	80 cm	150 cm	3

ULICOVÝ SMETÁK

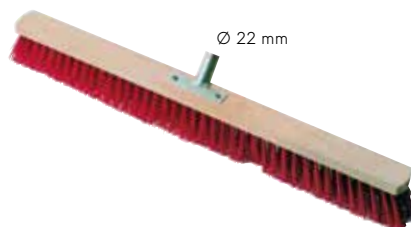

Č.p.	specifikace	
52101	30 cm	10
52102	40 cm	10
52103	50 cm	10
52104	60 cm	10
52105	80 cm	10

SÁLOVÝ SMETÁK S NÁSADOU



MOQ
3

Č.p.	specifikace	délka násady	
52185	40 cm	150 cm	3
52186	50 cm	150 cm	3
52187	60 cm	150 cm	3
52188	70 cm	150 cm	3
52189	80 cm	150 cm	3

SÁLOVÝ SMETÁK



Č.p.	specifikace	
52160	40 cm	10
52161	50 cm	10
52162	60 cm	10
52163	70 cm	10
52164	80 cm	10



SMETÁK



Č.p.	specifikace		
52114	28 cm	hrubý závit	1

SMETÁK S NÁSADOU



MOQ
3

Č.p.	specifikace	délka násady	
52116	28 cm	s násadou 130 cm	3

SMETÁK



Č.p.	specifikace		
52113	30 cm	hrubý závit	26
52115	30 cm	bez závitů	26

SMETÁK S NÁSADOU



MOQ
3

Č.p.	specifikace		
52195	30 cm	150 cm dřevěná	3
52196	30 cm	130 cm ALU	3

STĚRKA S GUMOU



Č.p.	specifikace		
15886	450 mm	násada Ø 23 mm	48
15887	600 mm	násada Ø 23 mm	48
15888	750 mm	násada Ø 23 mm	32

ULICOVÝ SMETÁK S NÁSADOU



Č.p.	specifikace		
52109	25 cm	120 cm dřevěná	12

NÁHRADNÍ MOP



Č.p.	specifikace		
52111	30 cm		1

ČISTÍCÍ MOP



Č.p.	specifikace		
52110	30 cm		16



SHRNOVAČE SNĚHU

SHRNOVAČ SNĚHU

FESTA

SHRNOVAČ SNĚHU

FESTA



Č.p.	specifikace	
60006	46 x 34 cm	12
60206	46 x 34 cm, složený	1

Č.p.	specifikace	
60008	50 x 34 cm	12
60208	50 x 34 cm, složený	1

SHRNOVAČ SNĚHU

MADE IN
EU

SHRNOVAČ SNĚHU

ALU



Č.p.	specifikace	
60001	48 x 40 cm	10
60201	48 x 40 cm, složený	1

Č.p.	specifikace	
60012	50 x 38 cm	12
60212	50 x 38 cm, složený	1

SEKÁČ NA LED



MOQ
3

Č.p.	specifikace
60022	20 cm

3

SEKÁČ NA LED

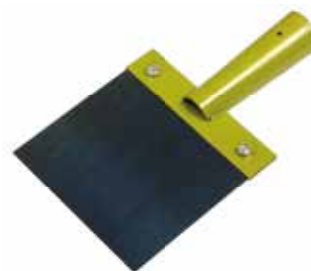

Č.p.	specifikace	
60018	15 cm	20
60019	20 cm	24
60020	30 cm	20
61201	násada 130 cm	10

POSYPOVÁ SŮL



Č.p.	specifikace
43300	10 kg
43301	25 kg

1
1

NÁSADA NA SMETÁK



Č.p.	specifikace	
61172	120 cm dřevěná násada s hrubým závitem	1
61192	150 cm dřevěná násada s hrubým závitem pro 52195	1
61193	150 cm dřevěná násada s hrubým závitem pro 52185 - 94	1
61194	140 cm dřevěná násada s hrubým závitem	1

NÁSADA NA SMETÁK



ALU



Č.p.	specifikace
52125	130 cm, jemný závit
52126	130 cm, hrubý závit

1
1

NÁSADA NA SMETÁK



Č.p.	specifikace		Č.p.	specifikace	
61171	1,2 m	1	61175	1,6 m	1
61173	1,4 m	1	61176	1,7 m	1
61174	1,5 m	1	61177	1,8 m	1

NÁSADA HLINÍKOVÁ

FESTA

ALU



Č.p.	specifikace
45330	161 cm
45331	100 cm

24
24

NÁSADA NA VIDLE A LOPATU - KOLÍNKO



Č.p.	specifikace	
61200	130 cm	10

NÁSADA NA LOPATU



Č.p.	specifikace	
61201	130 cm, rovná	10

NÁSADA NA RÝČ "T,"



Č.p.	specifikace
61208	90 cm



10

NÁSADA NA LOPATU "T,"



Č.p.	specifikace
61202	130 cm, rovná



10

NÁSADA NA ZEDNICKOU NABĚRAČKU



Č.p.	specifikace
61215	160 cm



10

NÁSADA NA RÝČ "Y,"



Č.p.	specifikace
61207	100 cm



10

NÁSADA NA KRUMPÁČ FIBERGLASS



· na krumpáč 2,5 kg 61040

Č.p.	specifikace
61206	95 cm



1

NÁSADA NA KRUMPÁČ



Č.p.	specifikace
61204	95 cm, úzká (pro 61120)
61205	95 cm



10

10

NÁSADA NA PLASTOVÉ HRÁBĚ



Č.p.	specifikace
61195	120 cm



10

NÁSADA NA MOTYKU



Č.p.	specifikace
61219	120 cm



10

NÁSADA NA HRÁBĚ



Č.p.	specifikace	vhodné pro	
61250	160 cm	45051, 61048	20
61251	160 cm	45052	20
61252	160 cm	45320	20
61253	160 cm	45053	20
61254	160 cm	45054	20
61255	160 cm	45070	20
61256	160 cm	45055	20



NÁSADA NA ŽELEZNÉ HRÁBĚ



Č.p.	specifikace	
61183	150 cm	10
61184	160 cm	10
61189	170 cm	10
61190	180 cm	10



10

10

10

10

PLASTOVÁ RUČKA "Y", NA NÁSADU



Č.p.	specifikace	
61230		10



10



SÍŤ PROTI HMYZU

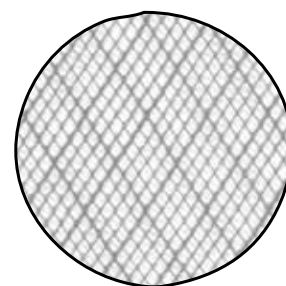

Č.p.	specifikace	
40100	1 x 25 m - PE bílá	1
40120	1,2 x 25 m - PE bílá	1

SÍŤ PROTI HMYZU

ALU

Zn

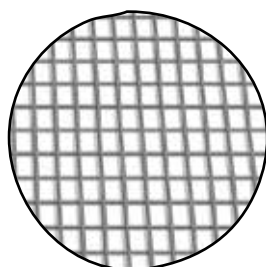

Č.p.	specifikace	
42101	1 x 30 m - ALUMINIUM	2
42103	1 x 30 m - galvanizovaný drát	2

SÍŤ PROTI HMYZU

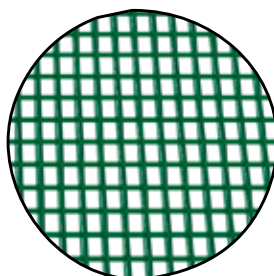

Č.p.	specifikace	
42102	1 x 30 m - zeleně lakovaný ocelový drát	2

DVEŘNÍ ZÁVĚS PROTI HMYZU



· variabilní rozměr 60 - 120 cm

Č.p.	specifikace	
40075	4 x 35 x 220 cm bílá	20
40076	4 x 35 x 220 cm černá	20

SÍŤ PROTI HMYZU - SKLOVLÁKNO

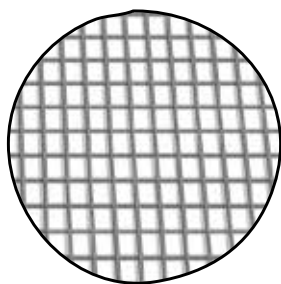

Č.p.	specifikace		
41083	0,8 x 30 m	bílá	6
41103	1 x 30 m	bílá	6
41123	1,2 x 30 m	bílá	6
41153	1,5 x 30 m	bílá	6

Č.p.	specifikace		
41082	0,8 x 30 m	bílá-šedá	6
41102	1 x 30 m	bílá-šedá	6
41122	1,2 x 30 m	bílá-šedá	6
41152	1,5 x 30 m	bílá-šedá	6

Č.p.	specifikace		
41050	0,5 x 30 m	šedá	6
41080	0,8 x 30 m	šedá	6
41100	1 x 30 m	šedá	6
41120	1,2 x 30 m	šedá	6
41150	1,5 x 30 m	šedá	6

Č.p.	specifikace		
41081	0,8 x 30 m	černá	6
41101	1 x 30 m	černá	6
41121	1,2 x 30 m	černá	6
41151	1,5 x 30 m	černá	6

OKENNÍ SÍŤ SE SUCHÝM ZIPEM - BÍLÁ



Č.p.	specifikace		
40050	150 x 130 cm	5,6 m	10
40052	150 x 180 cm	6,6 m	10
40054	150 x 90 cm	4,8 m	10
40056	220 x 75 cm 2 ks	5,8 m	10

OKENNÍ SÍŤ SE SUCHÝM ZIPEM - ČERNÁ



Č.p.	specifikace		
40057	150 x 130 cm	5,6 m	10
40058	150 x 180 cm	6,6 m	10
40059	150 x 90 cm	4,8 m	10

OKENNÍ SÍŤ SE SUCHÝM ZIPEM - ŠEDÁ



Č.p.	specifikace		
40051	150 x 130 cm	5,6 m	10
40053	150 x 180 cm	6,6 m	10
40055	150 x 90 cm	4,8 m	10

SUCHÝ ZIP SAMOLEPÍCÍ PRO OKENNÍ SÍŤ



Č.p.	specifikace	
40060	9 mm 7 m	1

PLETIVO HEX

Zn



· zinkováno před spletním

Č.p.	specifikace	
42150	13 0,7 x 1000 mm - 50 m	1
42151	16 0,7 x 1000 mm - 50 m	1
42152	20 0,7 x 1000 mm - 50 m	1
42153	25 0,8 x 1000 mm - 50 m	1

PLETIVO HEX

Zn



Č.p.	specifikace	
42155	13 0,7 x 1000 mm - 50 m	1
42156	16 0,7 x 1000 mm - 50 m	1
42157	20 0,7 x 1000 mm - 50 m	1
42158	25 0,8 x 1000 mm - 50 m	1

PLETIVO HEX POPLASTOVANÉ

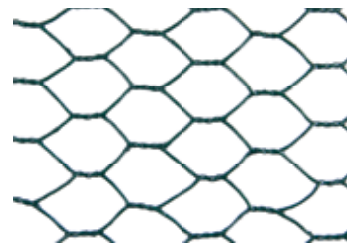



Č.p.	specifikace	
42160	13 1 x 1000 mm - 25 m	1
42161	16 1 x 1000 mm - 25 m	1
42162	20 1 x 1000 mm - 25 m	1
42163	25 1 x 1000 mm - 25 m	1

PLETIVO ČTVEREC

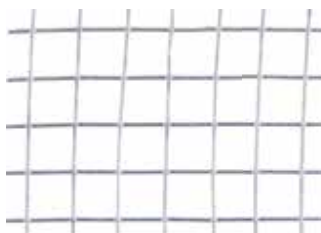
Zn



Č.p.	specifikace		Č.p.	specifikace	
42185	6 0,65 x 1000 mm - 25 m	1	42174	25 1,4 x 1000 mm - 25 m	1
42170	10 0,8 x 1000 mm - 25 m	1	42186	13 1,05 x 1000 mm - 25 m	1
42171	13 0,8 x 1000 mm - 25 m	1	42187	25 2,0 x 1000 mm - 25 m	1
42172	16 1,2 x 1000 mm - 25 m	1	42188	50 2,0 x 1000 mm - 25 m	1
42173	19 1,4 x 1000 mm - 25 m	1			

PLETIVO ČTVEREC - POPLASTOVANÉ



Č.p.	specifikace	
42180	13 1,2 x 1000 mm - 25 m	1
42181	16 1,2 x 1000 mm - 25 m	1
42182	25 2,3 x 1000 mm - 25 m	1

BEZPEČNOSTNÍ SÍŤ

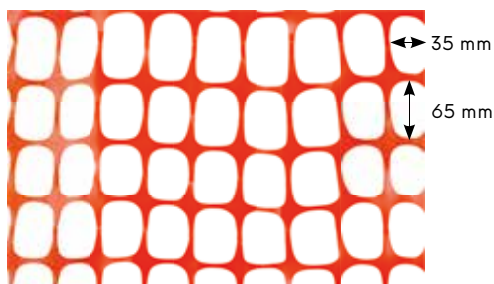
140
g/m²



Č.p.	specifikace	
42190	1,2 x 50 m HDPE 140g/m ²	1

OKRASNÉ PLETIVO POPLASTOVANÉ



Č.p.	velikost oka	Ø drátu	výška	length	
42175	15 x 9 mm	2 mm	40 cm	25 m	1
42176	15 x 9 mm	2 mm	65 cm	25 m	1
42177	15 x 9 mm	2 mm	90 cm	25 m	1
42178	15 x 9 mm	2 mm	120 cm	25 m	1
42179	15 x 9 mm	2 mm	25 cm	25 m	1

PLETIVO RABICOVÉ

Zn



Č.p.	specifikace	
42312	1 m 50 bm, 16 x 16 mm	1

SÍŤ PROTI PTÁKŮM



Č.p.	specifikace	
45570	2 x 5 m 18 x 18 mm	45
45571	2 x 10 m 18 x 18 mm	28
45572	4 x 5 m 18 x 18 mm	24
45573	4 x 10 m 18 x 18 mm	15

MADE IN EU

OCHRANA STROMŮ PROTI OKUSU

MADE IN EU

3x

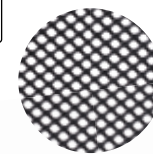

· samosvorná

Č.p.	specifikace	
45580	Ø 11 x 80 cm	1

VÁZACÍ DRÁT

Zn



Č.p.	Ø drátu	délka drátu	
42203	0,6 mm	30 m	50

VÁZACÍ DRÁT

Zn



Č.p.	Ø drátu	délka drátu	
42207	0,8 mm	50 m	40
42208	0,8 mm	100 m	20
42209	0,9 mm	100 m	20
42240	1,0 mm	50 m	40
42210	1,0 mm	100 m	20
42211	1,2 mm	50 m	40
42212	1,2 mm	100 m	20
42213	1,4 mm	30 m	40
42214	1,4 mm	50 m	20
42217	1,8 mm	30 m	40
42218	1,8 mm	50 m	20

NAPÍNACÍ DRÁT

Zn



Č.p.	Ø drátu	délka drátu	
42219	2,0 mm	26 m	20
42220	2,0 mm	52 m	20
42221	2,0 mm	78 m	20
42228	3,15 mm	26 m	10
42229	3,15 mm	52 m	10
42230	3,15 mm	78 m	10

VÁZACÍ DRÁT



Č.p.	Ø drátu	délka drátu	povrch	
42201	0,6 mm	30 m	PVC	50
42202	0,9 mm	30 m	PVC	50

DRÁT VÁZACÍ



Č.p.	Ø drátu	délka drátu	
42244	1,4 mm	50 m	20
42248	1,8 mm	50 m	20
42249	2,0 mm	50 m	20

DRÁT NAPÍNACÍ



Č.p.	Ø drátu	délka drátu	
42251	2,6 mm	26 m	20
42252	2,6 mm	52 m	20
42253	2,6 mm	78 m	20
42255	3,4 mm	26 m	10
42256	3,4 mm	52 m	10
42257	3,4 mm	78 m	10

OSTNATÝ DRÁT

Zn



Č.p.	Ø drátu	délka drátu	
42260	1,7 mm	50 m	1
42261	1,7 mm	100 m	1

SVORKA NAPÍNACÍHO DRÁTU

INOX



Č.p.	specifikace	
50040	nerez hrot, zelená	50
50041	nerez hrot, černá	50

SVORKA NAPÍNACÍHO DRÁTU

10x



Č.p.	specifikace	
50042		10

PLOTOVÝ NAPÍNÁK MALÝ

Zn



Č.p.	specifikace	
50030	pozink malý	50
50032	PVC malý	50

PLOTOVÝ NAPÍNÁK VELKÝ

Zn



Č.p.	specifikace	
50031	pozink	50
50033	PVC	50

PLOTOVÝ NAPÍNÁK MALÝ LT

Zn



Č.p.	specifikace	
50037	pozink	50
50038	PVC	50

NAPÍNACÍ ZAŘÍZENÍ



Č.p.	specifikace	
50035	2 t	6
50036	4 t	4

PŮDNÍ VRTÁK



Č.p.	Ø	A	B	
61299	110 mm	270 mm	1200 mm	1
61300	140 mm	270 mm	1200 mm	1
61301	170 mm	270 mm	1200 mm	1
61302	200 mm	270 mm	1200 mm	1

ZEMNÍ VRUT

Zn

6x

· redukce

- Ø 24 mm
- Ø 35 mm
- Ø 40 mm
- Ø 48 mm
- Ø 55 mm



Č.p.	Ø patky	délka patky	specifikace	
55450	60 mm	550 mm	1 ks + 5x redukce	8

KOTEVNÍ PATKA SLOUPKU

Zn



Č.p.	Ø patky	délka patky	tloušťka materiálu	
55400	71 x 71 mm	750 mm	2 mm	1
55401	91 x 91 mm	750 mm	2 mm	1
55406	81 x 81 mm	750 mm	2 mm	1
55402	91 x 91 mm	900 mm	2 mm	1
55403	101 x 101 mm	900 mm	2 mm	1
55404	121 x 121 mm	900 mm	2 mm	1
55405	151 x 151 mm	900 mm	2 mm	1

KOTEVNÍ PATKA SLOUPKU

Zn



Č.p.	Ø patky	délka patky	tloušťka materiálu	
55420	71 x 71 mm	150 mm	2 mm	1
55425	81 x 81 mm	150 mm	2 mm	1
55421	91 x 91 mm	150 mm	2 mm	1
55422	101 x 101 mm	150 mm	2 mm	1
55423	121 x 121 mm	150 mm	2 mm	1
55424	151 x 151 mm	150 mm	2 mm	1

KOTEVNÍ PATKA SLOUPKU

Zn



Č.p.	specifikace	tl.	
55436	70 x 75 mm 110 mm	4 mm	10
55437	80 x 90 mm 130 mm	4 mm	10

Ø 18 x 200mm

KOTEVNÍ PATKA SLOUPKU

Zn



Č.p.	specifikace	tl.	
55429	70 x 60 mm 100 mm	4 mm	10
55433	81 x 60 mm 100 mm	4 mm	10
55430	91 x 60 mm 100 mm	4 mm	10
55431	101 x 60 mm 100 mm	4 mm	10
55432	121 x 60 mm 100 mm	4 mm	10

Ø 18 x 200mm

ZEMNÍ VRUT "U,"

Zn

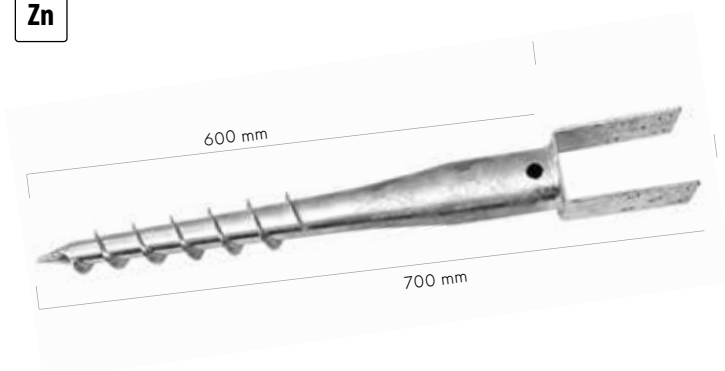

Č.p.	Ø patky	délka patky	tloušťka materiálu	
55455	71 x 60 mm	100 mm	4 mm	1
55452	81 x 60 mm	100 mm	4 mm	1
55456	90 x 60 mm	100 mm	4 mm	1
55453	101 x 60 mm	100 mm	4 mm	1
55457	110 x 60 mm	100 mm	4 mm	1
55454	121 x 60 mm	100 mm	4 mm	1

PATKA SLOUPKU S NASTAVITELNÝM ŠROUBEM

Zn



Č.p.	Ø patky	výška patky	závit	
55460	80 x 80 mm	150 mm	M16	10
55461	100 x 100 mm	150 mm	M16	10
55462	150 x 150 mm	150 mm	M24	10

BAMBUSOVÉ ZÁSTĚNY A STÍNÍCÍ TKANINY

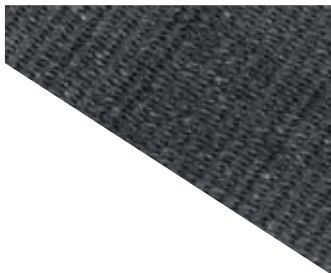
STÍNÍCÍ TKANINA HDPE 150 G/M² ANTRACIT150
g/m²

• stínění 85%

Č.p.	specifikace	
45496	1 x 10 m	1
45497	1,5 x 10 m	1
45498	1,8 x 10 m	1
45499	2 x 10 m	1

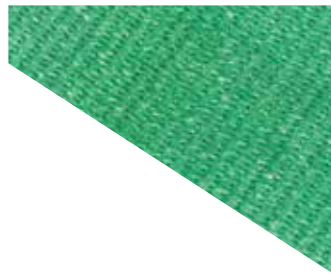
STÍNÍCÍ TKANINA HDPE 150 G/M²150
g/m²

• stínění 85%

Č.p.	specifikace	
45460	1 x 10 m	1
45461	1,5 x 10 m	1
45463	1,8 x 10 m	1
45462	2 x 10 m	1

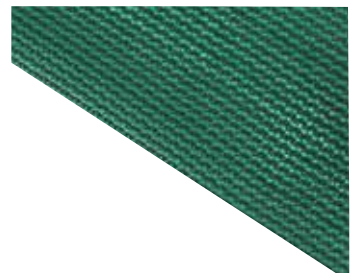
STÍNÍCÍ TKANINA HDPE 220 G/M²220
g/m²

• stínění 95%

Č.p.	specifikace	
45465	1 x 10 m	1
45466	1,5 x 10 m	1
45467	2 x 10 m	1

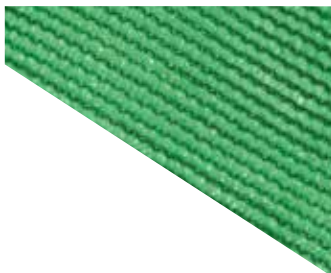
STÍNÍCÍ TKANINA HDPE 80 G/M²80
g/m²

Č.p.	specifikace	
45450	1 x 10 m	1
45451	1,5 x 10 m	1
45453	1,8 x 10 m	1
45452	2 x 10 m	1

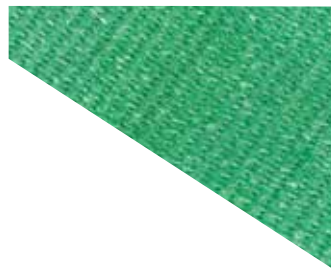
STÍNÍCÍ TKANINA HDPE 150 G/M²150
g/m²

• stínění 85%

Č.p.	specifikace	
45480	1,5 x 50 m	1

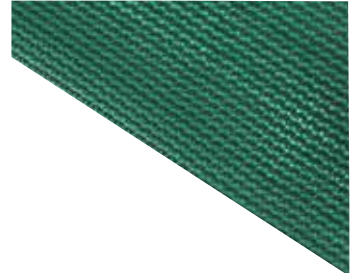
STÍNÍCÍ TKANINA HDPE 220 G/M²220
g/m²

• stínění 95%

Č.p.	specifikace	
45485	1,5 x 50 m	1

BAMBUS ŠTÍPANÝ



Č.p.	specifikace	
45410	1 x 5 m	1
45415	1,5 x 5 m	1
45420	2 x 5 m	1

ROHOŽ RÁKOSOVÁ



Č.p.	specifikace	
45425	1 x 5 m	5
45426	1,5 x 5 m	5
45427	2 x 5 m	5

UPÍNKA STÍNÍCÍ TKANINY

20x



Č.p.	specifikace	
45470		1



GRILOVÁNÍ

SADA NÁŘADÍ

INOX

18x



Č.p. specifikace

43077



6

SADA GRILOVACÍHO NÁŘADÍ

INOX

3x



GRILOVACÍ KLEŠTĚ

INOX



GRILOVACÍ TÁCEK

4x



Č.p. specifikace

43071 380 mm

16



Č.p. specifikace

43072 360 mm

25

Č.p. specifikace

43050 300 x 200 mm



50

GRILOVACÍ ROŠT



Č.p.	specifikace	
43058	58 x 30 mm	20
43060	60 x 40 mm	20
43068	68 x 40 mm	16

OPĚKACÍ MŘÍŽKA



Č.p.	specifikace	
43084	330 x 290 mm	50

OPĚKAČ RYB



Č.p.	specifikace	
43082	280 x 276 mm	50

OPĚKAČ RYB



Č.p.	specifikace	
43083	360 x 130 mm	12

ŠAŠLIKOVÉ JEHLICE

4x

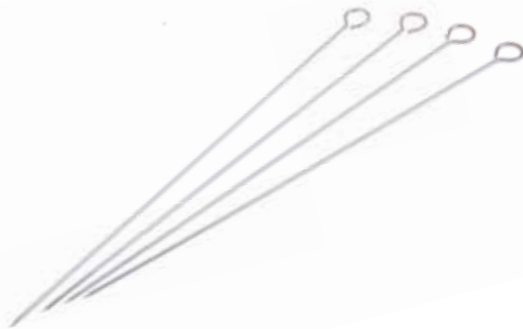

Č.p.	specifikace	
43086	Ø 3 x 380 mm	80

GRILOVACÍ VIDLICE



Č.p.	specifikace	
43097	100 cm	100

· grilovací vidlice s hygienickým atestem

GRILOVACÍ MOTOR 230V



Č.p. specifikace
43090



24

GRILOVACÍ MOTOREK BATERIOVÝ



· baterie typ D
Č.p. specifikace
43089



48

KARTÁČ NA ČIŠTĚNÍ 2 V 1



Č.p. specifikace
43098 30 cm



10

KARTÁČ 3 V 1



Č.p. specifikace
43099



40

MECHANICKÉ DMYCHADLO



Č.p. specifikace
43087



1



360

ZÁMKY, VISACÍ A ZÁMKY NA KOLA



364

POKLADNY A POŠTOVNÍ SCHRÁNKY



366

UPÍNACÍ POPRUHY



369

PROVAZY, MOTOUZY A VÁZACÍ PÁSKY



371

TAVNÉ PISTOLE



373

DRŽÁKY A NOSIČE



375

ČISTIČE ODPADU



377

DOMÁCÍ POTŘEBY



378

SVÍTILNY



381

PAPÍROVÉ PREZentaČNÍ STOJANY



382

REGÁLOVÝ SYSTÉM SU-5



386

ZEDNICKÉ NÁŘADÍ KUBALA

ŽELEZÁŘSKÉ ZBOŽÍ

358 - 391



ZÁMKY



TREZOR S ELEKTRONICKÝM ZÁMKEM

FESTA®

NEW



4x AA

- typ zámku: elektronický, mechanický
- bezpečnostní klíč
- rozměry 350x250x250mm
- hmotnost 10kg



Č.p. specifikace

23270

VLOŽKA ZÁMKU MOSAZNÁ

FESTA®

VLOŽKA ZÁMKU POMOSAZENÁ



3x



3x

Č.p. specifikace

23001 65 mm · 175 g

10



Č.p. specifikace

23000 65 mm · 75 g

15

ZÁMEK VISACÍ

FESTA



Č.p.	specifikace		Č.p.	specifikace	
23261	25 mm	12	23264	45 mm	6
23262	32 mm	12	23265	52 mm	12
23263	38 mm	6	23266	63 mm	6

ZÁMEK VISACÍ PRODLOUŽENÝ

FESTA



Č.p.	specifikace		Č.p.	specifikace	
23211	25 mm	12	23214	45 mm	12
23212	32 mm	12	23215	52 mm	6
23213	38 mm	6			

ZÁMEK VISACÍ MOSAZNÝ POPLASTOVANÝ

FESTA



Č.p.	specifikace		Č.p.	specifikace	
23310	30 mm	10			
23311	40 mm	10			
23312	50 mm	6			

ZÁMEK MOSAZNÝ ZESÍLENÝ

FESTA



Č.p.	specifikace		Č.p.	specifikace	
23125	25 mm	12	23140	40 mm	12
23130	30 mm	12	23150	50 mm	12
23135	35 mm	12	23160	60 mm	12

ZÁMEK VISACÍ

FESTA



Č.p.	specifikace		Č.p.	specifikace	
23273	50 mm	12			
23274	60 mm	10			
23275	70 mm	10			

ZÁMEK VISACÍ



Č.p.	specifikace		Č.p.	specifikace	
23220	25 mm	12	23240	40 mm	6
23225	30 mm	12	23250	50 mm	12
23232	32 mm	15	23260	60 mm	12

ZÁMEK POMOSAZENÝ

3x



Č.p.	specifikace		Č.p.	specifikace	
23020	20 mm	12	23040	40 mm	12
23025	25 mm	12	23050	50 mm	12
23030	30 mm	12	23060	60 mm	12
23035	35 mm	12			

ZÁMEK POMOSAZENÝ PRODLOUŽENÝ

3x



Č.p.	specifikace	
23070	40 mm	12

ZÁMEK VISACÍ

3x



Č.p.	specifikace	
23010	50 mm	6

ZÁMEK VISACÍ

2x



Č.p.	specifikace	
23005	40 mm	12
23006	50 mm	6

ZÁMEK NA KOLO S ČÍSELNÝM KÓDEM

FESTA®



Č.p.	specifikace	
23288	120 cm x Ø 10 mm	1

ZÁMEK NA KOLO S ČÍSELNÝM KÓDEM

FESTA®



Č.p.	specifikace	
23287	65 cm x Ø 10 mm	1

ZÁMEK NA KOLO S ÚCHYTEM

FESTA
2x

Č.p.	specifikace	
23290	120 cm x Ø 8 mm	20
23291	150 cm x Ø 8 mm	20
23292	180 cm x Ø 8 mm	20

ZÁMEK NA KOLO S ÚCHYTEM

2x

Č.p.	specifikace	
23296	150 cm x Ø 8 mm	25
23297	180 cm x Ø 8 mm	25

ZÁMEK NA KOLO

2x

Č.p.	specifikace	
23282	55 cm x Ø 8 mm	50
23284	65 cm x Ø 8 mm	50

ZÁVORA UZAMYKATELNÁ

3x

Č.p.	
51500	1

ZÁMEK VISACÍ S ČÍSELNÝM KÓDEM



Č.p.	
23281	20

VISAČKY KE KLÍČŮM

100x

• zesílený kroužek

Č.p.	
23391	50

VISAČKY KE KLÍČŮM

100x

Č.p.	
23390	1

PETLICE



Č.p.	specifikace	
51514	100 mm	25
51515	120 mm	25
51516	140 mm	25
51517	160 mm	25

ZÁSTRČ



Č.p.	specifikace	
51510	100 mm	12
51511	120 mm	12
51512	140 mm	12
51513	160 mm	12



POKLADNY A POŠTOVNÍ SCHRÁNKY

SCHRÁNKA NA KLÍČE



Č.p.	specifikace	
70140	250 x 180 x 80 mm - pro 48 klíčů	12
70141	300 x 230 x 90 mm - pro 90 klíčů	8

POKLADNA



Č.p.	šířka	hloubka	výška	
70120	125 mm	95 mm	60 mm	1

POKLADNA



Č.p.	šířka	hloubka	výška	
70121	152 mm	118 mm	80 mm	30

POKLADNA



Č.p.	šířka	hloubka	výška	
70122	200 mm	160 mm	90 mm	20

POKLADNA



Č.p.	šířka	hloubka	výška	
70123	250 mm	180 mm	90 mm	16

POKLADNA



Č.p.	šířka	hloubka	výška	
70124	300 mm	240 mm	90 mm	10

POKLADNA



Č.p.	šířka	hloubka	výška	
70125	370 mm	280 mm	90 mm	7

SCHRÁNKA POŠTOVNÍ PLASTOVÁ



Č.p.	barva	šířka	hloubka	výška	
70113	bílá	240 mm	105 mm	345 mm	6

SCHRÁNKA POŠTOVNÍ PLASTOVÁ



Č.p.	barva	šířka	hloubka	výška	
70114	hnědá	240 mm	105 mm	345 mm	6

SCHRÁNKA POŠTOVNÍ



Č.p.	barva	šířka	hloubka	výška	
70101	bílá	290 mm	360 mm	105 mm	5
70100	hnědá	290 mm	360 mm	105 mm	5

SCHRÁNKA POŠTOVNÍ



Č.p.	barva	šířka	hloubka	výška	
70102	bílá	310 mm	260 mm	90 mm	10
70103	hnědá	310 mm	260 mm	90 mm	6

SCHRÁNKA POŠTOVNÍ



Č.p.	barva	šířka	výška	hloubka	
70104	bílá	310 mm	360 mm	90 mm	6
70105	hnědá	310 mm	360 mm	90 mm	6

SCHRÁNKA POŠTOVNÍ



Č.p.	barva	šířka	hloubka	výška	
70108	bílá	370 mm	134 mm	364 mm	5

SCHRÁNKA POŠTOVNÍ



Č.p.	materiál	šířka	hloubka	výška	
70107	nerez	360 mm	100 mm	520 mm	6

SCHRÁNKA POŠTOVNÍ



Č.p.	materiál	šířka	hloubka	výška	
70106	nerez	360 mm	100 mm	360 mm	5

SCHRÁNKA POŠTOVNÍ



Č.p.	materiál	šířka	hloubka	výška	
70109	nerez	310 mm	90 mm	260 mm	6

SCHRÁNKA POŠTOVNÍ



Č.p.	materiál	šířka	hloubka	výška	
70110	nerez	310 mm	90 mm	360 mm	6



UPÍNACÍ POPRUHY

POPRUHY UPÍNACÍ SAMONAVÍJECÍ



2x



Č.p.	šířka	délka	nosnost	ks	
51070	18 mm	2 m	100 kg	2	8

POPRUH UPÍNACÍ SAMONAVÍJECÍ



Č.p.	šířka	délka	nosnost	ks	
51071	25 mm	3,5 m	300 kg	1	12

POPRUH UPÍNACÍ SAMONAVÍJECÍ



Č.p.	šířka	délka	nosnost	ks	
51072	35 mm	4 m	500 kg	1	6

POPRUH UPÍNACÍ



Č.p.	šířka	délka	nosnost	ks	
51040	25 mm	6 m	1000 kg	1	1
51041	35 mm	8 m	2000 kg	1	1
51042	35 mm	8 m	3000 kg	1	1
51043	50 mm	10 m	5000 kg	1	1

POPRUHY UPÍNACÍ



2x



Č.p.	šířka	délka	nosnost	ks	
51060	25 mm	5 m	750 kg	2	5

POPRUH UPÍNACÍ



Č.p.	šířka	délka	nosnost	ks	
51065	50 mm	10 m	960 kg	1	6

POPRUH UPÍNACÍ



Č.p.	šířka	délka	nosnost	ks	
51026	75 mm	5 m	3000 kg	1	4

POPRUH UPÍNACÍ



Č.p.	šířka	délka	nosnost	ks	
51017	50 mm	6 m	480 kg	2	5
51018	50 mm	6 m	480 kg	1	10

POPRUH UPÍNACÍ



Č.p.	šířka	délka	specifikace	
51022	25 mm	5 m	s háky	40
51023	50 mm	5 m	s háky	12

POPRUH UPÍNACÍ



PE



• měkčená EVA podložka

Č.p.	šířka	délka	ks	
51046	38 mm	4 m	1	30

POPRUH UPÍNACÍ



Č.p.	šířka	délka	specifikace	
51030	50 mm	6 m	s háky	20
51034	50 mm	8 m	s háky	10

POPRUHY UPÍNACÍ

2x



Č.p.	šířka	délka	ks	
51020	25 mm	2,5 m	2	100

POPRUH UPÍNACÍ

PE



Č.p.	šířka	délka	ks	
51045	25 mm	4 m	1	50

GUMY UPÍNACÍ NASTAVITELNÉ

2x



Č.p.	délka	Ø	ks	
51013	1,2 m	8 mm	2	30

GUMY UPÍNACÍ

2x



Č.p.	délka	ks	
51008	1 m	2	25

GUMA UPÍNACÍ S KARABINAMI



Č.p.	délka	Ø	ks	
51009	1 m	10 mm	1	50

SADA UPÍNACÍCH POPRUHŮ

8x

- 2 x 0,4 m
- 2 x 0,6 m
- 1 x 0,8 m
- 1 x 1,0 m



Č.p.	délka	Ø	ks	
51011	1 m	8 mm	8	10

GUMY UPÍNACÍ

2x



Č.p.	délka	Ø	ks	
51001	80 cm	10 mm	2	50
51002	100 cm	10 mm	2	50
51003	150 cm	10 mm	2	50
51004	200 cm	10 mm	2	50

GUMY UPÍNACÍ S HÁKY

2x



Č.p.	délka	Ø	ks	
51007	1 m	8 mm	2	25

GUMY UPÍNACÍ - PAVOUK



Č.p.	délka	Ø	specifikace	
51010	80 cm	8 mm	8 ramen	50

PRUŽNÁ UPEVŇOVACÍ SÍŤ S HÁKY



Č.p.	délka	šířka	
51015	80 cm	120 cm	20

LANO ELASTICKÉ



Č.p.	délka	Ø	
51036	20 m	8 mm	10
51037	20 m	10 mm	6

HÁČKY K UPÍNACÍM GUMÁM

20x



Č.p.	délka	
51038	8 mm	30

KARABINA

ALU



MOQ
2

Č.p.	Ø	délka		Č.p.	Ø	délka	
51186	4 mm	40 mm	2	51202	7 mm	70 mm	2
51187	5 mm	50 mm	2	51201	8 mm	80 mm	2
51200	6 mm	60 mm	2	51203	10 mm	100 mm	2

PROVÁZEK SILONOVÝ



Č.p.	délka	Ø	
51055	80 m	1,5 mm	50
51056	50 m	2 mm	50
51057	20 m	4 mm	50

MOTOUZ POLYPROPYLEN



Č.p.	váha	
50905	80 g	80
50906	100 g	100
50907	200 g	50

MOTOUZ JUTA



Č.p.	váha	
50900	80 g (61 m)	1
50901	100 g (76 m)	1
50902	200 g (153 m)	1

LANO PRŮMYSLOVÉ



Č.p.	délka	Ø	
50915	5 m	8 mm	1
50916	25 m	8 mm	1
50917	25 m	10 mm	1
50918	25 m	12 mm	1
50919	25 m	14 mm	1

LANO SILONOVÉ



Č.p.	délka	Ø	
51050	50 m	8 mm	10
51051	50 m	10 mm	4

MOTOUZ POLYPROPYLEN



Č.p.	váha	
50909	500 g (250 m)	1
50910	1000 g (500 m)	1
50911	5000 g (2500 m)	1

ŠŤŮRA VOSKOVANÁ



Č.p.	délka	Ø	
50920	50 m	1 mm	80

PÁSKY VÁZACÍ S ÚCHYTEM

10x



Ø 15 - 32 mm



Č.p.	délka	šířka	
23865	160 mm	7,5 mm	1

PÁSKY VÁZACÍ BAREVNÉ

100x



EN 50146
nylon



Č.p.	délka	šířka	
23880	100 mm	2,5 mm	1
23882	150 mm	2,5 mm	1
23884	200 mm	3,6 mm	1

PÁSKY VÁZACÍ ČERNÉ

50x



EN 50146
nylon

Č.p.	délka	šířka	
23810	120 mm	2,5 mm	1
23814	200 mm	3,6 mm	1
23816	250 mm	3,6 mm	1
23818	250 mm	4,8 mm	1
23820	300 mm	4,8 mm	1
23824	400 mm	4,8 mm	1
23826	500 mm	4,8 mm	1
23828	400 mm	7,6 mm	1
23830	500 mm	7,6 mm	1

PÁSKY VÁZACÍ BÍLÉ

50x



EN 50146
nylon



Č.p.	délka	šířka	
23850	120 mm	2,5 mm	1
23854	200 mm	3,6 mm	1
23856	250 mm	3,6 mm	1
23858	250 mm	4,8 mm	1
23860	300 mm	4,8 mm	1
23864	400 mm	4,8 mm	1
23866	500 mm	4,8 mm	1
23868	400 mm	7,6 mm	1
23870	500 mm	7,6 mm	1

VÁZACÍ PÁSKA, SUCHÝ ZIP



Č.p.	specifikace	
45471	12 mm x 5 m	1

PÁSKA NA SUCHÝ ZIP 3 KS



3x



Č.p.	šířka	délka	
37295	20 mm	150 mm	1
37296	20 mm	200 mm	1
37297	20 mm	250 mm	1

PISTOLE TAVNÁ - BEZDRÁTOVÁ



Č.p. specifikace

89975 80 W | 230 V Ø tavné tyčinky 11,2 mm



20

PISTOLE TAVNÁ



Č.p. specifikace

89973 60 W | 230 V Ø tavné tyčinky 11,2 mm



20

PISTOLE TAVNÁ



Č.p. specifikace

89970 15 W | 230 V Ø tavné tyčinky 7,2 mm



20

TYČINKY DO TAVNÉ PISTOLE - ČIRÉ



Č.p. Ø tyčinky délka počet ks v balení

89985	11,2 mm	200 mm	10	50
89987	11,2 mm	200 mm	1 kg	25



50

TYČINKY DO TAVNÉ PISTOLE - ČIRÉ



Č.p. Ø tyčinky délka počet ks v balení

89980	7,2 mm	100 mm	12	100
89988	7,2 mm	100 mm	1 kg	25



100

TYČINKY DO TAVNÉ PISTOLE - BAREVNÉ



Č.p. Ø tyčinky délka počet ks v balení

89990	11,2 mm	200 mm	10	50
-------	---------	--------	----	----



50

TYČINKY DO TAVNÉ PISTOLE - BAREVNÉ



Č.p. Ø tyčinky délka počet ks v balení

89989	7,2 mm	100 mm	12	100
-------	--------	--------	----	-----



100

PISTOLE HORKOVZDUŠNÁ S REGULACÍ TEPLoty



FESTA



napětí / frekvence	230V / 50Hz
příkon	2000W
poloha spínače	0 - I (350°C) - II (600°C)
příslušenství	nerozové nástavce - 4 ks

Č.p.	specifikace
35320	2000 W



5

PISTOLE HORKOVZDUŠNÁ S REGULACÍ TEPLoty A PROUDU VZDUCHU



FESTA

- digitální display



napětí / frekvence	230V / 50Hz
příkon	2000W
poloha spínače	0 - I (50°C) - II (50 - 600°C)
proud vzduchu	250 - 500 l/min.
příslušenství	nerozové nástavce - 4 ks

Č.p.	specifikace
35322	2000 W



5

KABEL PRODLUŽOVACÍ S NAVIJÁKEM



- Prodlužovací přívod s navijákem 25 m - IP20
- H05VV - F 3G 1,5mm², - Vybavený tepelnou pojistkou
- Výkon v navinutém stavu : 1000 W max.
- Výkon v rozvinutém stavu : 3000 W max.
- 4 uzemněné zásuvky s dětskou pojistkou



Č.p.	specifikace		
37760	4 zásuvky	délka 25 m, IP 20, 1,5 mm ²	2
37761	4 zásuvky	délka 50 m, IP 20, 1,5 mm ²	2

KABEL PRODLUŽOVACÍ



Č.p.	specifikace		
37730	max. 3680 W	délka 10 m, 1,5 mm ²	8
37731	max. 3680 W	délka 20 m, 1,5 mm ²	4

SKLENÁŘSKÝ DRŽÁK



SKLENÁŘSKÝ DRŽÁK

ALU



poloha	max. nosnost
horizontální poloha	50 kg
vertikální poloha	50 kg



Č.p.	specifikace
36314	jednoduchý

20

Č.p.	specifikace
36305	jednoduchý

60

SKLENÁŘSKÝ DRŽÁK



SKLENÁŘSKÝ DRŽÁK

ALU



poloha	max. nosnost
horizontální poloha	80 kg
vertikální poloha	100 kg



Č.p.	specifikace
36313	dvojitý

20

Č.p.	specifikace
36306	dvojitý

20

SKLENÁŘSKÝ DRŽÁK



SKLENÁŘSKÝ DRŽÁK

NEW

ALU



NEW



poloha	max. nosnost
horizontální poloha	120 kg
vertikální poloha	150 kg

poloha	max. nosnost
horizontální poloha	80 kg
vertikální poloha	100 kg



Č.p.	specifikace
36318	trojitý

10

Č.p.	specifikace
36319	trojitý

10

MINCÍŘ ANALOGOVÝ



Č.p.	maximální nosnost
24260	50 kg



MINCÍŘ



Č.p.	maximální nosnost	
24212	12,5 kg	48
24225	25 kg	6
24250	50 kg	6
24255	100 kg	6
24258	150 kg	6

PINZETA S LED SVĚTLEM



Č.p.	specifikace
50005	95 mm



SADA PINZET NEREZ

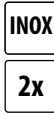

Č.p.	specifikace
50004	



PAST NA MYŠI

2x



Č.p.	specifikace
70221	90 x 45 mm dřevěná



PAST NA MYŠI

2x



Č.p.	specifikace
70220	97 x 47 mm plastová



ČISTÍCÍ MOP



Č.p.	specifikace
52110	30 cm



NÁHRADNÍ MOP

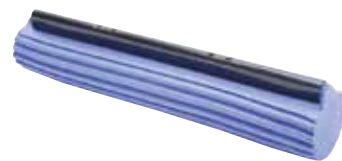

Č.p.	specifikace
52111	30 cm



ČISTIČ ODPADU



Ø 15 mm

· možnost použití s vrtačkou



6

Č.p.	délka	Ø
50014	6 m	6 mm

ČISTIČ ODPADU



Ø 5mm

Č.p.	délka	Ø	
50009	3 m	5 mm	40

ČISTIČ ODPADU

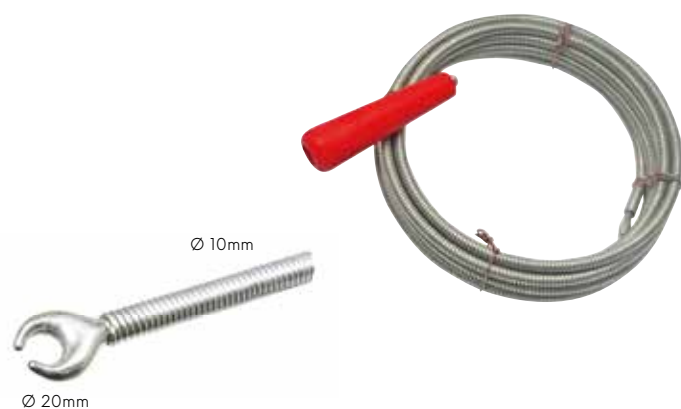

Ø 10mm

Ø 20mm

Č.p.	délka	
50010	3 m	20
50011	5 m	10
50012	10 m	6
50013	15 m	4

PUMPA NA ČIŠTĚNÍ ODPADU



Č.p.	délka	Ø	
50015	385 mm	65 mm	36

ELEKTRIKÁŘSKÉ PROTAHOVACÍ PÉRO



Č.p.	délka	Ø	
51181	8 m	5 mm	25
51182	10 m	5 mm	25



25

SBĚRAČ ODPADKŮ



· otočné o 90°

Č.p.	délka
61235	81 cm

12

SBĚRAČ ODPADKŮ



· max. 4 kg

Č.p.
61236

12

TELESKOPICKÁ TYČ

ALU



Č.p.	délka	ALU	
52010	120 cm	ALU	50
52012	240 cm	ALU	25



TELESKOPICKÁ TYČ



Č.p.	délka	ocel	
52020	300 cm	ocel	10



TELESKOPICKÁ TYČ



Č.p.	délka	fiberglass	
52030	240 cm	fiberglass	6



OLEJNIČKA



Č.p.	specifikace	
50020	300 ml	10

MAZNICE

přímé plnění
plnění kartuší
plnění čerpadlem

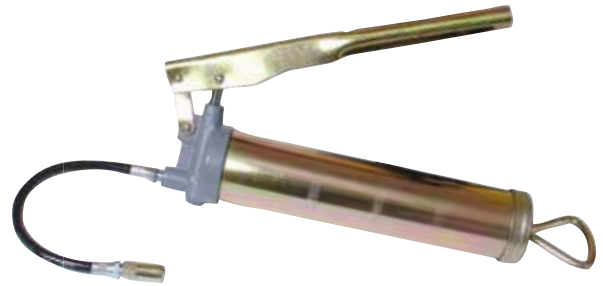

Č.p.	specifikace	
50022	400 ml	20

BARELOVÁ PUMPA



Č.p.	
50017	10

OLEJNIČKA



Č.p.	specifikace	
50019	90 ml	1

POVOLOVAČ FILTRŮ

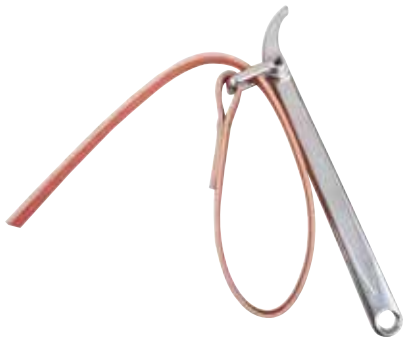

Č.p.	specifikace	
50021	60 x 140 mm	6

TRYCHTÝŘ



Č.p.	specifikace	
50025	60 x 140 mm	50

HADICE PŘEČERPÁVACÍ SE SAMONASÁVACÍM VENTILEM



Č.p.	délka	ø	
50026	180 cm	15 mm	24

SVÍTILNY

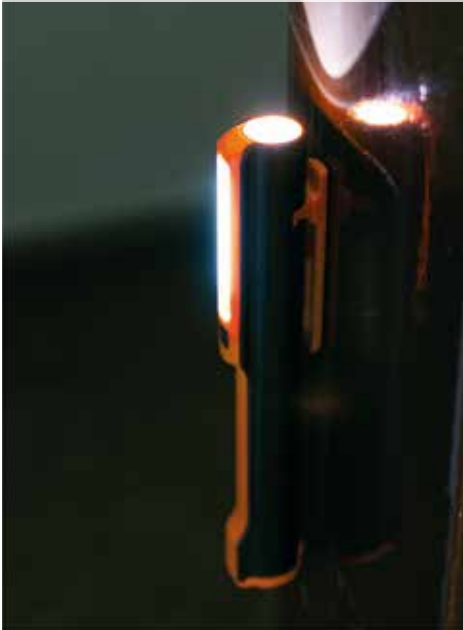

LED SVÍTILNA

LED light



3x AAA

FESTA®

· magnety k připevnění např: na kovová zárubně aj.



· magnetický, otočný, klip

MOQ
12

Č.p.	specifikace
37645	200 mm 3 x AAA

12

LED ČELOVKA

LED light

3x AAA

120 lumen

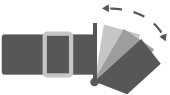

Váha	42 g
Zdroj světla	1 x 1 W white LED + 2x red LED
Baterie	3 x AAA
Rozměry	40 x 59 x 32 mm
Doba svícení	45 h
Tok světla	120 lumen
Dosvit	60 m (100% battery)
Režimy svícení	4

· 5 pozic vyklopení

Č.p.	specifikace
37641	2 druhy světla, bílé a červené



1

LED ČELOVKA

LED light

3x AAA

120 lumen



FESTA®

Č.p.	specifikace
37640	120 lumen + červené světlo



6

LED SVÍTLNA

FESTA

LED light

3x AA



220 lumen

měkčené poplastování



130 lumen

nastavitelná rukojeť



úchytka s háčky



č.p.

37650



12

LED SVÍTLNA

FESTA

ALU

LED light

2x AA

80 lumen



č.p.

specifikace

37630

185 mm

2 x AA



20

LED SVÍTLNA

LED light



č.p.	37621
výkon	0,6 W
barevná teplota	700k
baterie	2xD
váha	138g
délka dosvitu	30 m
světelnost	50 lm

č.p.

specifikace

37621

185 mm



6

KONZOLA BÍLÁ

MOQ
2

Č.p.	specifikace	
81100	100 x 75 mm	24
81101	125 x 100 mm	24
81102	150 x 125 mm	24
81103	200 x 150 mm	24
81104	250 x 200 mm	24
81105	300 x 250 mm	24
81106	350 x 300 mm	24

KONZOLA HNĚDÁ

MOQ
2

Č.p.	specifikace	
81113	200 x 150 mm	24
81114	250 x 200 mm	24
81115	300 x 250 mm	24

REGÁLOVÁ STOJKA JEDNODUCHÁ



REGÁLOVÝ HÁK JEDNODUCHÝ



Č.p.	specifikace	
81053	50 cm	10
81054	80 cm	10
81055	100 cm	10
81056	150 cm	10
81057	200 cm	10



Č.p.	specifikace	
81070	10 cm	10
81071	15 cm	10
81072	20 cm	10
81073	25 cm	10
81074	30 cm	10
81075	35 cm	10
81076	40 cm	10
81077	50 cm	10



PAPÍROVÝ PREZentaČNÍ STOJAN FESTA



Č.p. specifikace
81600 60 x 40 x 175 cm - CZ



PAPÍROVÝ PREZentaČNÍ STOJAN FESTA POWER TOOLS



Č.p. specifikace
81603 60 x 40 x 175 cm



PAPÍROVÝ PREZentaČNÍ STOJAN NA NIVELAČNÍ SYSTÉMY



Č.p. specifikace
37129 60 x 40 x 175 cm - CZ
37123 60 x 40 x 175 cm - osazený
37124 60 x 40 x 175 cm - osazený





STOJAN FESTA + PŘÍSLUŠENSTVÍ



Č.p.	specifikace	
81011	stojan FESTA 220 x 100 cm	1
81011A	stojan 81011 + samolepka AQUATIC	1
81011F	stojan 81011 + samolepka FESTA CZ	1
81011G	stojan 81011 + samolepka FESTA GB	1
81011H	stojan 81011 + samolepka FESTA SK	1
81011R	stojan 81011 + samolepka ROSA	1
81012	police FESTA 100 x 40 cm	8
81013	háček 10 cm	10
81014	háček 16 cm	10
81015	háček 20 cm	10
81035	háček s visačkou 20 cm	10
81016	háček 30 cm	10
81036	háček s visačkou 30 cm	10
81022	koš na hladítka - velký, 50 cm	1
81023	koš na hladítka - malý, 40 cm	1
81024	příčka ke koši - velká, 50 cm	1
81025	příčka ke koši - malá, 40 cm	1



REGÁLOVÝ SYSTÉM SU - 5



RÁDI VÁM SESTAVÍME NABÍDKU NA POŽADOVANOU REGÁLOVOU SESTAVU

Č.p.	specifikace	Č.p.	specifikace	Č.p.	specifikace
81200	Stojina 40/2400 mm kotvená	81293	Závěs jednoduchý 100	81389	Zadní panel 200/1250mm plný
81201	Stojina 80/1108 mm	81294	Závěs jednoduchý 200	81390	Zadní panel 400/1250mm plný
81202	Stojina 80/1208 mm	81295	Závěs jednoduchý 300	81391	Zadní panel 200/1250mm děrovaný
81203	Stojina 80/1408 mm	81296	Jednoháček s hrazdou 200	81393	Kryt gondoly 80/1250mm
81204	Stojina 80/1608 mm	81297	Jednoháček s hrazdou 300	81392	Zadní panel 400/1250mm děrovaný
81205	Stojina 80/1808 mm	81298	Zámek vitríny	81394	Kryt gondoly 60/1250mm
81206	Stojina 80/2000 mm	81299	Dělitko drátěné 360mm vysoké	81395	Nosník závěsů 1250mm
81207	Stojina 80/2108 mm	81300	Dělitko drátěné 460 mm vysoké	81396	Police 200/1250mm
81208	Stojina 80/2208 mm	81301	Dělitko drátěné 560 mm vysoké	81439	Nosník závěsů 1000 mm
81209	Stojina 80/2308 mm	81302	Dělitko drátěné 560 mm nízké	81344	Police 300/1000 zesílená
81210	Stojina 80/2408 mm	81303	Konzola 300 dvojitá L	81345	Police 400/1000 zesílená
81211	Stojina 80/2600 mm	81304	Konzola 300 dvojitá P	81346	Police 500/1000 zesílená
81212	Stojina 60/1000 mm	81305	Konzola 400 dvojitá L	81397	Police 300/1250mm
81213	Stojina 60/1208 mm	81306	Konzola 400 dvojitá P	81400	Police 300/1250mm, zesílená
81214	Stojina 60/1408 mm	81307	Konzola 500 dvojitá L	81401	Police 400/1250mm, zesílená
81215	Stojina 60/1608 mm	81308	Konzola 500 dvojitá P	81402	Police 500/1250mm, zesílená
81216	Stojina 60/1808 mm	81309	Police půlkruh 300	81398	Police 400/1250mm
81217	Stojina 60/2108 mm	81310	Police půlkruh 400	81399	Police 500/1250mm
81218	Stojina 60/2208 mm	81311	Police půlkruh 500	81404	Čelní opěra nízká 1250mm, plast bílý
81225	Stojina 30/2108 mm přední	81312	Šokl půlkruhu 500	81405	Cenovková lišta, 1250mm
81486	Stojina 60/2000 mm	81313	Celo soklu půlkruhu 500	81406	Hřeben 1250mm
81219	Nástavec stojiny 80x30/100mm	81314	Držák cenovky pol. 300 půlkruh	81407	Držák cenovky, 1250mm
81220	Nástavec stojiny 80x30/400 mm	81315	Držák cenovky pol. 400 půlkruh	81408	Celo zastřešení, 1250mm
81221	Nástavec stojiny 80x30/600 mm	81316	Držák cenovky pol. 500 půlkruh	81409	Deska zastřešení, 600x1250mm
81222	Nástavec stojiny 60x30/400 mm	81317	Police půlkruh 600	81410	Zadní panel 100/625 plný
81223	Stojina rohová 90st. 2100mm	81318	Šokl půlkruhu 600	81411	Zadní panel 200/625 plný
81224	Stojina rohová 90st. 2200mm	81319	Celo soklu půlkruhu 600	81412	Zadní panel 400/625 plný
81226	Podpěra 80	81320	Cenovka P 7,5x5 cm	81413	Zadní panel 400/625 děrovaný
81227	Podpěra 60	81321	Cenovka P 2,6x3,2 cm	81414	Kryt gondol 80/650
81228	Spojka gondoly s regálem 80	81322	Cenovka P 5,0x4,0 cm	81415	Kryt gondol 60/650
81229	Kotevní lišta	81323	Police děrovaná 500/1000	81416	Nosník závěsů, modul 3
81230	Kotevní hák	81324	Spojnice stojin 80, modul 1	81432	Nosník závěsů, 1330mm
81231	Kotvení lehké	81325	Zadní panel 10x100cm	81417	Police 300/625
81232	Kotvení vrchní	81326	Zadní panel 20x100cm	81418	Police 400/625
81233	Výplň 400	81327	Zadní panel 40x100cm	81419	Police 500/625
81234	Výplň 500	81328	Zadní panel dř. 20x100 cm EUR	81421	Čelní opěra nízká 625, plast bílý
81235	Výplň 600	81329	Zadní panel dř. 40x100 cm EUR	81422	Cenovková lišta 625mm
81236	Výplň 700	81330	Kryt gondol 8x100cm	81423	Hřeben 625mm
81237	Výplň 800	81331	Kryt gondol 6x100cm	81424	Držák cenovky, 625mm
81238	Konzola nízká 200	81332	Nosník závěsů 100cm	81425	Zadní panel 100/1330 plný
81239	Konzola nízká 300	81333	Police skleněná 985/300 vitrína	81457	Čelní opěra nízká 200 plast
81240	Konzola nízká 400	81334	Police skleněná 985/400 vitrína	81426	Zadní panel 200/1330 plný
81241	Konzola nízká 500	81335	Police dřevěná 47/98,5	81427	Zadní panel 400/1330 plný
81242	Konzola vysoká 400	81336	Police drátěná 1000/500	81428	Zadní panel 200/1330 děrovaný S
81243	Konzola vysoká 500	81337	Police korytová 1000x500	81429	Zadní panel 400/1330 děrovaný S
81244	Konzola vysoká 600	81338	Police 200/1000	81430	Kryt gondol 80/1330
81245	Konzola vysoká 700	81339	Police 300/1000	81431	Kryt gondol 60/1330
81246	Konzola nízká 300 dvojitá	81340	Police 400/1000	81433	Police 300/1330
81247	Konzola nízká 400 dvojitá	81341	Police 500/1000	81434	Police 400/1330
81248	Konzola nízká 300 dvojitá	81342	Police 400/1000 RAL7015	81435	Police 500/1330
81251	Konzola RR 80	81343	Police 500/1000 RAL7015	81436	Cenovková lišta, 1330 mm
81249	Konzola vysoká dvojitá 500	81347	Rám vysoké vitríny 1000/400	81437	Hřeben 1330 mm
81250	Nosník vys. vitríny 400/2000	81348	Skló rámu vysoké vitríny 1000/400	81438	Držák cenovky 1330 mm
81252	Dělitko korytové police	81349	Zásuvková vložka regálová	81440	Police drátěná - koš
81253	Dělitko nízké 300	81350	Podhled kovové police 500/100	81441	Zadní panel 100 koutový
81254	Dělitko nízké 400	81352	Čelní opěra vysoká 1000 mm, sklo	81442	Zadní panel 400 koutový
81255	Dělitko nízké 500	81353	Čelní opěra vysoká, plexi	81443	Celo soklu koutové 500/1000mm
81256	Dělitko nízké 300 sklo	81354	Čelní opěra nízká 1000 mm, plast	81444	Celo soklu koutové 600 mm
81257	Dělitko nízké 400 sklo	81355	Cenovková lišta, 1000mm	81445	Zadní panel koutový 400mm děrovaný
81258	Dělitko nízké 500 sklo	81356	Hřeben zásuvky regálů	81447	Police 300 koutová
81259	Dělitko vysoké 300 sklo	81351	Hřeben pro vysoká dělitka, 1000	81448	Police 400 koutová
81262	Dělitko vysoké 300 plexi	81357	Hřeben, 1000 mm	81449	Police 500 koutová
81263	Dělitko vysoké 400 plexi	81403	Hřeben pro vysoká dělitka, 1250 mm	81450	Police 600 koutová
81264	Dělitko vysoké 500 plexi	81420	Hřeben pro vysoká dělitka, 625 mm	81451	Držák cenovky 300 koutový
81260	Dělitko vysoké 400 sklo	81358	Dvoudrážky dvířek vitríny	81452	Držák cenovky 400 koutový
81261	Dělitko vysoké 500 sklo	81359	Držák cenovky, 1000mm	81453	Držák cenovky 500 koutový
81265	Bok vys. vitríny 400/2000	81360	Dveře vys. vitríny 1000/2000	81454	Lišta cenovková 300 koutová
81266	Bočnice zastřešení RR 80	81361	Celo zastřešení, 1000mm	81455	Lišta cenovková 400 koutová
81267	Bočnice zásobníku 500mm	81362	Deska zastřešení, 1000mm	81456	Lišta cenovková 500 koutová
81268	Bočnice vitríny 500	81363	Dvířka zásobníku	81458	Police drátěná koš U 1000/400
81269	Nosník horní vitríny 500	81364	Dvířka vitríny posuvná	81459	Police drátěná koš U 1000/500
81271	Bočnice police nízká 300 plast	81365	Zrcadlo vitríny	81460	Rohové celo soklu 90st.
81272	Bočnice police nízká 400 plast	81366	Závěsový rám, modul 1	81461	Panel zadní rohový 100, stojina 60
81273	Bočnice police nízká 500 plast	81367	Závěsová tyč	81462	Panel zadní rohový 200, stojina 60
81274	Bočnice vysoká sklo 300/250	81370	Koš drátěný šikmý	81463	Panel zadní rohový 400, stojina 80
81275	Pojistka bočnice	81371	Pult s plnou deskou 1000mm	81466	Panel zadní rohový 100, stojina 80
81276	Bočnice vysoká sklo 500/250	81372	Sokl pultu SU 5 1000mm	81467	Panel zadní rohový 400, stojina 60
81277	Bočnice police vysoká 400	81373	Pult prosklený 1000mm	81468	Police rohová 90st. 400mm
81278	Bočnice police vysoká 500	81374	Pult s nerez deskou 1000mm	81469	Police rohová 90st. 500mm
81270	Nosník zastřešení RR 80	81375	Pult s plnou deskou 600mm	81470	Držák cenovky rohový 90st. 400mm
81279	Nosník zastřešení	81376	Police do pultu 600mm	81471	Držák cenovky rohový 90st. 500mm
81280	Bočnice zastřešení levá	81377	Pult prosklený 600mm	81472	Cenovková lišta rohová 90st. 400mm
81281	Bočnice zastřešení pravá	81378	Police do pultu 1000mm	81473	Cenovková lišta rohová 90st. 500mm
81282	Závěsová rameno	81379	Polička pultu dlouhá		
81284	Rameno dvojitě 400/10	81380	Segment pultu vysoký 90st.		
81285	Rameno dvojitě 300/8	81381	Dvoudrážka pultu 1000mm, pár		
81286	Rameno jednoduché 350	81382	Dvířka posuvná, pult 1000mm, pár		
81287	Rameno jednoduché 500	81383	Zásuvka pod desku		
81288	Rameno jednoduché 250	81384	Police drátěná RDE 1000/360mm		
81289	Závěs dvojitý 100	81385	Police drátěná RDE 1000/460mm		
81290	Závěs dvojitý 200	81386	Police drátěná RDE 1000/560mm		
81291	Závěs dvojitý 300	81387	Cenovková lišta RDE 1000 mm		
81292	Závěs 130 V	81388	Zadní panel 100/1250mm plný		

TRADE KONZOLA

· kompatibilní se stojanem FESTA

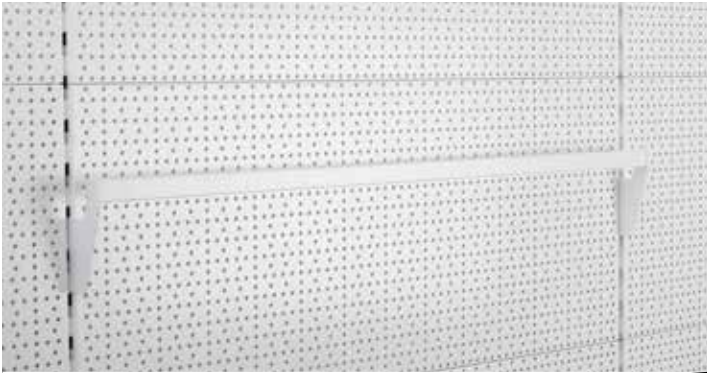

Č.p.	specifikace
81150	1000 × 50 × 135 mm



TRADE KONZOLA

· kompatibilní se stojanem FESTA

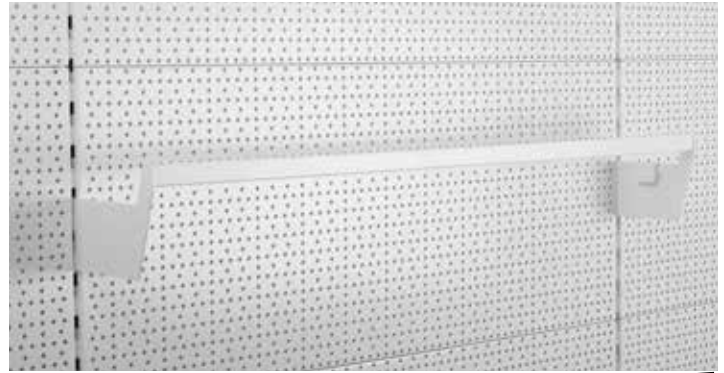

Č.p.	specifikace
81151	1000 × 150 × 135 mm



TRADE KONZOLA

· kompatibilní se stojanem FESTA

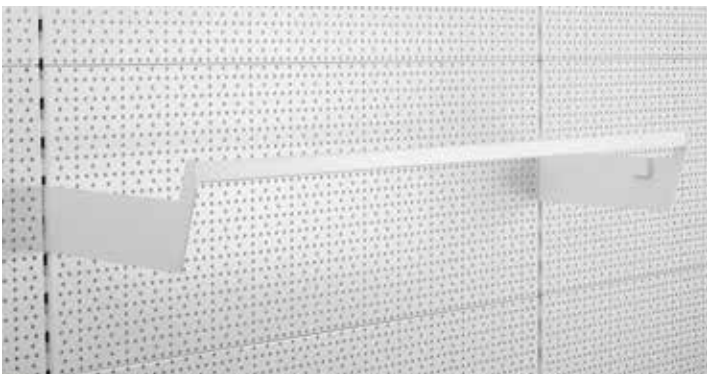

Č.p.	specifikace
81152	1000 × 350 × 135 mm

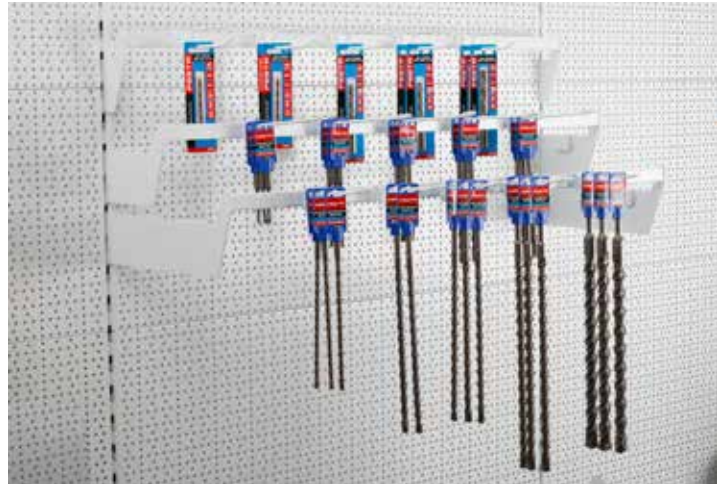

DRŽÁK CENOVKOVÉ LIŠTY

· kompatibilní se stojanem FESTA



Č.p.	specifikace
81155	1000 × 80 × 100 mm



RÁM PRO ŘEZNÉ KOTOUČE

· kompatibilní se stojanem FESTA

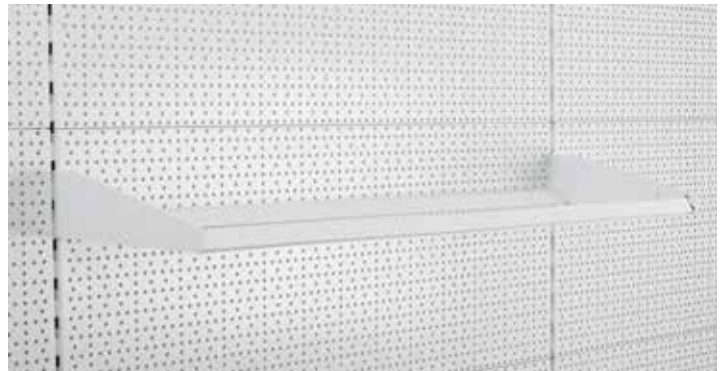

Č.p.	specifikace
81170	1000 × 450 × 85 mm



HÁK PRO ŘEZNÉ KOTOUČE

· kompatibilní se stojanem FESTA

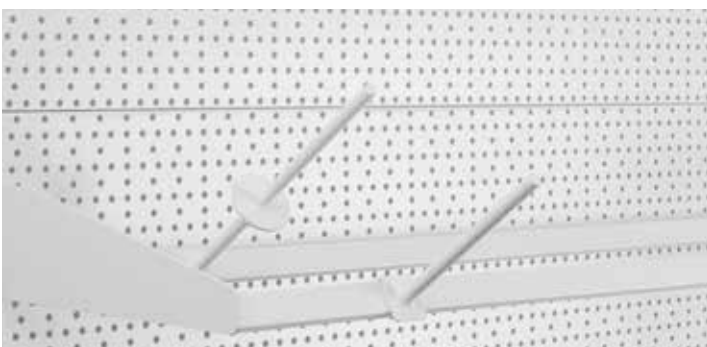

Č.p.	specifikace
81186	150 mm
81185	250 mm



HÁK PRO AKU NÁŘADÍ

· kompatibilní se stojanem FESTA



Č.p.
81189



DRŽÁK NA PILY

· kompatibilní se stojanem FESTA

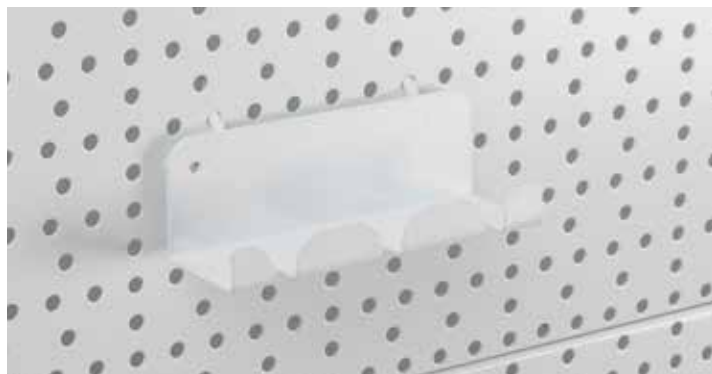

Č.p. specifikace

81190



1

POLICE PRO KOTOUČE

· kompatibilní se stojanem FESTA



Č.p. specifikace

81191 220 x 220 x 200 mm



1

KOŠ ZÁVĚSNÝ

· kompatibilní se stojanem FESTA

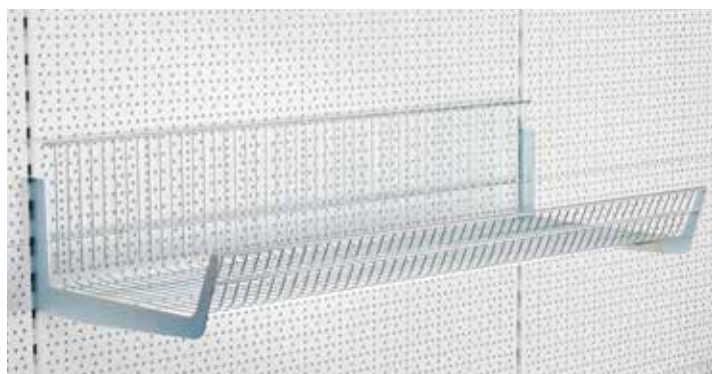

Č.p. specifikace

81160 1000 x 470 x 180 mm



1



DĚLÍTKO

· kompatibilní se stojanem FESTA



Č.p. specifikace

81165 470 x 180 mm



1

HÁK DVOJITÝ NA HRAZDU

· kompatibilní se stojanem FESTA

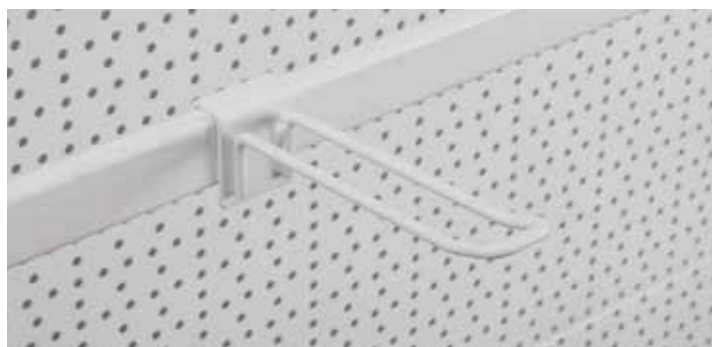

Č.p. specifikace

81175 120 mm



1

81178 180 mm

HÁK JEDNODUCHÝ NA HRAZDU

· kompatibilní se stojanem FESTA



Č.p. specifikace

81180 120 mm



1

HLADÍTKO NEREZ

Kubala

INOX



Č.p.	specifikace		
33100	130 x 270 mm	hladké, 2 zaoblené rohy	10

HLADÍTKO NEREZ

Kubala

INOX



Č.p.	specifikace		
33102	130 x 270 mm	hladké, G-1 ručka	10

HLADÍTKO NEREZ

Kubala

INOX



Č.p.	specifikace		
33105	130 x 350 mm	hladké, G-8 ručka	6

HLADÍTKO NEREZ

Kubala

INOX



Č.p.	specifikace		
33107	110 x 270 mm	rohové	10

HLADÍTKO NEREZ

Kubala

INOX



Č.p.	specifikace		
33110	130 x 270 mm	hladké, G-11 ručka	10

HLADÍTKO NEREZ

Kubala

INOX



Č.p.	specifikace		
33112	130 x 270 mm	zub 6 x 6, G-11 ručka	10
33113	130 x 270 mm	zub 8 x 8, G-11 ručka	10
33114	130 x 270 mm	zub 10 x 10, G-11 ručka	10

HLADÍTKO NEREZ

Kubala

INOX



Č.p.	specifikace		
33120	130 x 480 mm	hladké, G-12 ručka	10

HLADÍTKO NEREZ

Kubala

INOX



Č.p.	specifikace		
33123	130 x 480 mm	zub 8 x 8, G-12 ručka	10
33124	130 x 480 mm	zub 10 x 10, G-12 ručka	10

HLADÍTKO NEREZ OBLÉ ROHY

INOX



Č.p.	specifikace	
33127	130 x 480 mm 2 zaoblené rohy	10

HLADÍTKO NEREZ " BENÁTSKÉ "

INOX



Č.p.	specifikace	
33131	80 x 200 mm G-1 ručka	10
33132	75 x 95 x 240 mm trapezové G-1 ručka	10

HLADÍTKO NEREZ

INOX



Č.p.	specifikace	
33135	130 x 270 mm šikmé zuby 8 mm, G-1 ručka	10

HLADÍTKO NEREZ

INOX



Č.p.	specifikace	
33137	130 x 270 mm zub půlkulatý, G-1 ručka	10

LŽÍCE ŠTUKATÉRSKÁ

INOX



Č.p.	specifikace	
33140	50 mm	20
33141	60 mm	20
33142	80 mm	20
33143	100 mm	20

HLADÍTKO PLASTOVÉ ABS



Č.p.	specifikace	
33150	130 x 240 mm	12

HLADÍTKO PLASTOVÉ



Č.p.	specifikace	
33151	180 x 400 mm	1
33152	130 x 600 mm	1

HLADÍTKO PLASTOVÉ



Č.p.	specifikace	
33154	130 x 270 mm G-17 ručka	12

ŠKRABÁK NA KAMENNOU VLNU



Zn

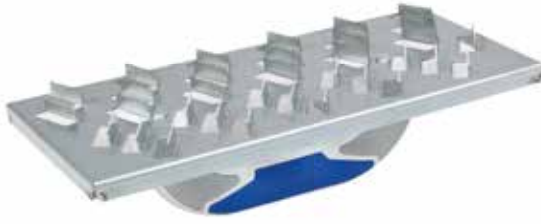

MOQ
2

Č.p.	specifikace
32328	285 x 145 mm

10

HLADÍTKO PRO BRUSNOU MŘÍŽKU



Č.p.	specifikace
33160	105 x 210 mm s podkladovou gumou

20

HLADÍTKO BRUSNÉ



INOX



MOQ
2

Č.p.	specifikace
33162	130 x 270 mm
33163	180 x 400 mm
33164	160 x 380 mm

20
10
10

HLADÍTKO BRUSNÉ PLASTOVÉ



Č.p.	specifikace
33165	165 x 365 mm

MOQ
2

10

HLADÍTKO BRUSNÉ



INOX



MOQ
2

Č.p.	specifikace
33166	130 x 600 mm

2

HLADÍTKO BRUSNÉ S OTVORY



Č.p.	specifikace
33167	130 x 270 mm G-17 ručka
33168	160 x 380 mm G-17 ručka
33170	180 x 400 mm G-17 ručka

MOQ
2

20
10
10

HLADÍTKO BRUSNÉ S OTVORY



MOQ
2

Č.p.	specifikace
33169	160 x 380 mm děrované, G-16 ručka

10

ŠKRABÁK PLASTOVÝ S HŘEBY



Č.p.
33173

MOQ
2

2

STĚRKA NEREZOVÁ



INOX



Č.p.	specifikace	
33200	40 mm	20
33201	60 mm	20
33202	80 mm	20
33203	100 mm	20

STĚRKA NEREZOVÁ



INOX



Č.p.	specifikace	
33205	130 x 90 mm	20

STĚRKA NEREZOVÁ



INOX



Č.p.	specifikace	
33206	130 x 37 mm	20

STĚRKA NEREZOVÁ



INOX



Č.p.	specifikace	
33207	150 mm s bitem PH2	30

STĚRKA NEREZOVÁ



INOX



Č.p.	specifikace	
33208	350 x 90 mm	10

STĚRKA NEREZOVÁ



INOX



Č.p.	specifikace	
33209	335 x 37 mm	20

STĚRKA NEREZOVÁ



INOX



Č.p.	specifikace	
33210	150 mm G-15 ručka	10
33211	250 mm G-15 ručka	10
33212	350 mm G-15 ručka	10

STĚRKA NEREZOVÁ FASÁDNÍ



INOX



Č.p.	specifikace	
33215	600 mm AL uchycení, G-14 ručka	10

STĚRKA PLASTOVÁ



Č.p.	specifikace		
33220	145 mm s gumou		10

STĚRKA PLASTOVÁ



Č.p.	specifikace		
33221	245 mm s gumou		10

HLADÍTKO PLASTOVÉ, GUMA POD ÚHLEM



Č.p.	specifikace		
33155	95 x 240 mm s podkladovou gumou		5

SOUPRAVA PRO OBKLADAČE



Č.p.	specifikace		
33250			1

KBELÍK OBDÉLNÍKOVÝ



Č.p.	specifikace		
33254	16 l mřížka, kolečka		1
33255	20 l mřížka, kolečka		1

SOUPRAVA PRO OBKLADAČE MINI



Č.p.	specifikace		
33252			1

DÍLY PRO VYMÝVACÍ SADY



Č.p.	specifikace		
33257	trojté válečky do kbelíku		1

DÍLY PRO VYMÝVACÍ SADY



Č.p.	specifikace		
33256	válečky do kbelíku		1
33258	válečky do kbelíku		1

DISTANČNÍ SPONY SMART LEVEL

100x

· nivelační klínky 33246



Č.p.	specifikace	
33247	1 mm	15
33248	2 mm	15
33249	3 mm	15

NIVELAČNÍ KLÍNKY

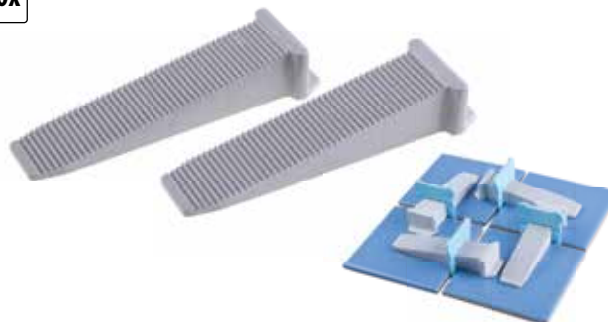
50x

Č.p.	specifikace	
33246	Smart Level	15

NABĚRAČKA PLASTOVÁ

MISKA NA SÁDRU GUMOVÁ

STĚRKA GUMOVÁ



Č.p.	specifikace	
33270	175 mm	20

Č.p.	specifikace	
33275	0,5 l	20

Č.p.	specifikace	
33280	200 mm	10
37010	135 mm	20

NIVELAČNÍ VÁLEČEK

ŠKRABÁK NA BARVY CIDLINKA



Č.p.	specifikace	
33289	85 x 230 mm	15

Č.p.	specifikace	
33285	60 mm	1
33286	náhradní ostří 60 mm	1

VRTÁK DO POROBETONU

POKOSNICE PLASTOVÁ



Č.p.	specifikace	
33291	60 mm	1
33292	80 mm	1
33293	120 mm	1

Č.p.	specifikace	
33298	250 x 80 x 50 mm	1
33299	300 x 115 x 65 mm	1





AUTODOPLŇKY

392 - 403



HYDRAULICKÝ ZVEDÁK, JEDNOPÍSTOVÝ



- stavitelný šroub umožňuje jemné nastavení výšky a maximální zdvih
- dvojitý bezpečnostní přepouštěcí ventil
- velká vroubkovaná dosedací plocha pro bezpečné podepření
- široká základna zajišťuje stabilitu a odolnost
- všechny silně namáhané body jsou zesílené pro zvýšení odolnosti a životnosti



Č.p.	specifikace	nosnost	min. výška	zdvih	jemné nastavení výšky	rozměry základny	váha	
26800	Hydraulický zvedák	2 000 kg	181mm	116 mm	48 mm	88 x 92 mm	2,6 kg	1
26801	Hydraulický zvedák	3 000 kg	194 mm	118 mm	60 mm	92 x 100 mm	3,3 kg	1
26802	Hydraulický zvedák	5 000 kg	216 mm	127 mm	70 mm	96 x 112 mm	4,5 kg	1
26803	Hydraulický zvedák	8 000 kg	230 mm	147 mm	80 mm	103 x 118 mm	5,7 kg	1
26804	Hydraulický zvedák	10 000 kg	230 mm	150 mm	80 mm	110 x 123 mm	6,8 kg	1
26805	Hydraulický zvedák	12 000 kg	230 mm	155 mm	80 mm	116 x 134 mm	7,3 kg	1
26806	Hydraulický zvedák	15 000 kg	230 mm	150 mm	80 mm	133 x 136 mm	8,4 kg	1
26807	Hydraulický zvedák	20 000 kg	242 mm	150 mm	60 mm	144 x 152 mm	11 kg	1

HYDRAULICKÝ ZVEDÁK, DVOUPÍSTOVÝ



- stavitelný šroub umožňuje jemné nastavení výšky a maximální zdvih.
- dvojitý bezpečnostní přepouštěcí ventil.
- velká vroubkovaná dosedací plocha pro bezpečné podepření.
- široká základna zajišťuje stabilitu a odolnost.
- všechny silně namáhané body jsou zesílené pro zvýšení odolnosti a životnosti.



Č.p.	specifikace	nosnost	min. výška	zdvih	jemné nastavení výšky	váha	
26815	Hydraulický zvedák teleskopický	2 000 kg	150 mm	160 mm	60 mm	4,7 kg	1
26816	Hydraulický zvedák teleskopický	4 000 kg	160 mm	170 mm	60 mm	6,4 kg	1
26817	Hydraulický zvedák teleskopický	6 000 kg	215 mm	270 mm	-	8,9 kg	1
26819	Hydraulický zvedák teleskopický	10 000 kg	228 mm	284 mm	89 mm	10,2 kg	1

NŮŽKOVÝ ZVEDÁK



Č.p.	specifikace	nosnost	min. výška	max. výška	váha	
26844	Nůžkový zvedák	1 000 kg	88 mm	380 mm	2,5 kg	1
26845	Nůžkový zvedák	2 000 kg	120 mm	395 mm	3,5 kg	1

HYDRAULICKÝ POJÍZDNÝ ZVEDÁK



Č.p.	specifikace	nosnost	min výška	max výška	váha	
26820	Hydraul. zvedák pojízdný, přenosný	2 000 kg	130 mm	345 mm	9,6 kg	1
26826	Hydraul. zvedák pojízdný, nízký profil, 360° otoč. madlo	2 000 kg	89 mm	359 mm	14,2 kg	1
26824	Hydraul. zvedák pojízdný, dílenský, nožní pedál	3 000 kg	145 mm	500 mm	37,2 kg	1
26825	Hydraul. zvedák pojízdný, dílenský, nízký profil, profi	2 500 kg	85 mm	455 mm	34,8 kg	1

HYDRAULICKÝ POJÍZDNÝ ZVEDÁK, HLINÍKOVÝ, NÍZKOPROFILOVÝ



Č.p.	specifikace	nosnost	min výška	max výška	
26840		2 000 kg	100 mm	465 mm	1

HYDRAULICKÝ POJÍZDNÝ ZVEDÁK + PODPĚRY



· ovládací tyč otočná o 360°

Č.p.	specifikace	nosnost	min výška	max výška	váha	
26829	Hydraulický zvedák pojízdný 2ks stavitelné podpěry	2 000 kg	130 mm	350 mm	10,5 kg	1
		2 000 kg	275 mm	420 mm	5 kg (pair)	

STAVITELNÁ PODPĚRA

- 1ks = 1pár
- hřeben pro přesné nastavení výšky s dvojitým zajištěním
- masivní ocelová rukojeť
- velká dosedací plocha, silná konstrukce rámu
- litinová podpěrná část



Č.p.	specifikace	nosnost	min výška	max výška	váha	
26857	Stavitelná podpěra - pár; s pojistkou	2 000 kg	275 mm	420 mm	5 kg	1
26858	Stavitelná podpěra - pár; s pojistkou	3 000 kg	285 mm	425 mm	6,4 kg	1
26859	Stavitelná podpěra - pár; s pojistkou	2 000 kg	390 mm	605 mm	13,7 kg	1
26853	Stavitelná podpěra - pár	2 000 kg	465 mm	715 mm	27,3 kg	1

HYDRAULICKÝ JEŘÁBOVÝ ZVEDÁK, SKLÁDACÍ

- pro zvedání a ukládání agregátů při jejich montáži a demontáži
- nosné rameno má několik poloh vysunutí a podle toho se také řídí nosnost jeřábu
- konstrukce ve sklopném provedení umožňuje, aby jeřáb zabíral mimo provoz malý prostor



Č.p.	specifikace	nosnost	min výška	max výška	váha	
26862	Hydraulický jeřábový zvedák, skládací	2 000 kg	0	2360 mm	88 kg	1

OPĚRNÝ DRŽÁK MOTORU

· kyvadlové zavěšení ramene držáku v závislosti na sklonu kapoty, zajišťuje vždy vyvážené a stabilní upevnění motoru



Č.p.	specifikace	nosnost	délka	rozsah	váha	
26871	Opěrný držák motoru	500 kg	1500 mm	150 mm	20,3 kg	1

HYDRAULICKÝ ZVEDÁK PŘEVODOVKY

· snadná montáž a demontáž agregátů (motorů, převodovek, náprav apod.)



Č.p.	specifikace	nosnost	délka	rozsah	váha	
26880	Hydraulický zvedák převodovky	500 kg	1100 mm	1900 mm	30,0 kg	1
26881	Nástavec pro automatické převodovky	500 kg	1100 mm	1900 mm	15,0 kg	1

ROZPÍNACÍ SOUPRAVA

· hydraulické zařízení pro opravování karoserií vozidel
 · skládá se z hydraulického rozpínacího válce a 14ti dílů příslušenství
 · široký rozsah využití při opravách karoserií osobních, dodávkových a nákladních vozidel především v místech, kde není možnost napojení na zdroje energie
 · zařízení lze využít pro rozpínání, stlačování, zvedání a natahování ve vertikálních i horizontálních směrech
 · jednoduché přenášení v plastovém kufru



Č.p.	specifikace	nosnost	hydraulický zdvih	váha	
26886	Rozpínací souprava	4 000 kg	125 mm	17,0 kg	1
26888	Rozpínací souprava	10 000 kg	135 mm	32,0 kg	1

STOJAN NA MOTOR

- pojízdný stojan pro upevnění a práci na demontovaných motorech
- univerzální upínací jednotka umožňuje jak upnutí motoru, tak jeho otáčení



Č.p.	specifikace	nosnost	váha	
26920	Stojan na motor polohovatelný, pojízdný	450 kg	20 kg	1
26921	Stojan na motor polohovatelný, pojízdný	560 kg	27 kg	1
26922	Stojan na motor polohovatelný, pojízdný, skládací	675 kg	35 kg	1

RUČNÍ LANOVÝ NAVIJÁK

Zn

- kvalitní pozinkovaný naviják s odolným ocelovým lanem



Č.p.	specifikace	Ø průměr lana	max.zátěž	délka lana	
26705	Ruční lanový naviják	4,0mm	450 kg	10 m	1
26706	Ruční lanový naviják	5,0mm	900 kg	10 m	1
26707	Ruční lanový naviják	6,0mm	1350 kg	10 m	1
26720	Ruční lanový naviják	4,0mm	300 kg	10 m	1
26721	Ruční lanový naviják	4,0mm	500 kg	10 m	1
26722	Ruční lanový naviják	5,0mm	800 kg	10 m	1

ŘETĚZOVÝ ZVEDÁK



Č.p.	specifikace	zátěž	min. výška	zdvih	počet kladek	síla řetězu	váha	
26700	Řetězový zvedák	500 kg	280 mm	3 000 mm	1	6 mm	7,5 kg	1
26701	Řetězový zvedák	1 000 kg	300 mm	3 000 mm	1	6 mm	9 kg	1
26702	Řetězový zvedák	2 000 kg	380 mm	3 000 mm	2	6 mm	12 kg	1

STLAČOVAČ PRUŽIN

- 26897 - pro demontáž pružin typu mopherson přímo na vozidle.
- 26943 - pro demontáž pružin typu mopherson mimo vozidlo masivní ocelové profily pro větší stabilitu.



Č.p.	specifikace	zátěž	Ø stlač. pružiny	rozpětí stlačení	váha	
26897	Stlačovač pružin přenosný	1 000 kg	100-200 mm	150 mm	24,5 kg	1
26943	Stlačovač pružin	1 000 kg	400 mm	210-570 mm	35 kg	1

HYDRAULICKÝ LIS



Č.p.	specifikace	rozsah	max.zátěž	váha	
26940	Hydraulický lis	0 - 610 mm	12 000 kg	43 kg	1
26941	Hydraulický lis	0 - 880 mm	20 000 kg	75 kg	1

HYDRAULICKÁ OHÝBAČKA TRUBEK

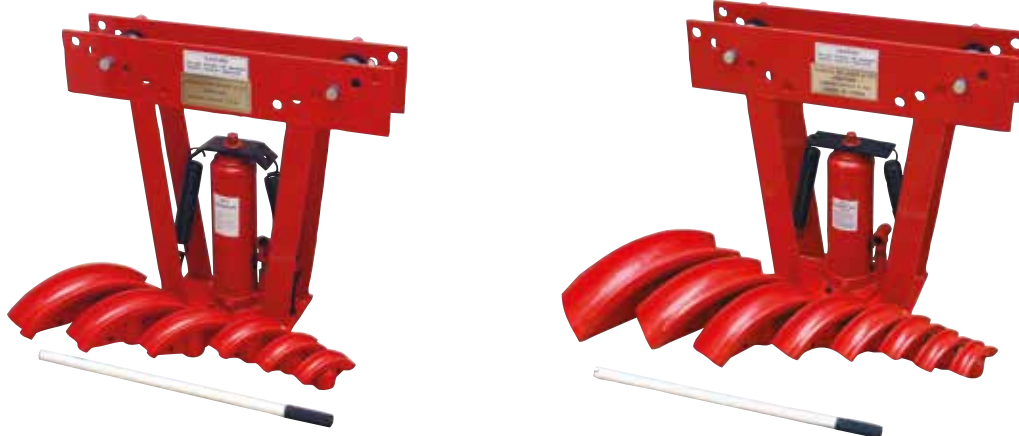

Č.p.	specifikace	zátěž	zdvih	ohýbací kolena	váha	
26895		12 000 kg	232 mm	1 2", 3 4", 1", 1-1 4", 1-1 2", 2"	36 kg	1
26896		16 000 kg	238 mm	1 2", 3 4", 1", 1-1 4", 1-1 2", 2", 2-1 2", 3"	65 kg	1

HYDRAULICKÝ VÁLEC

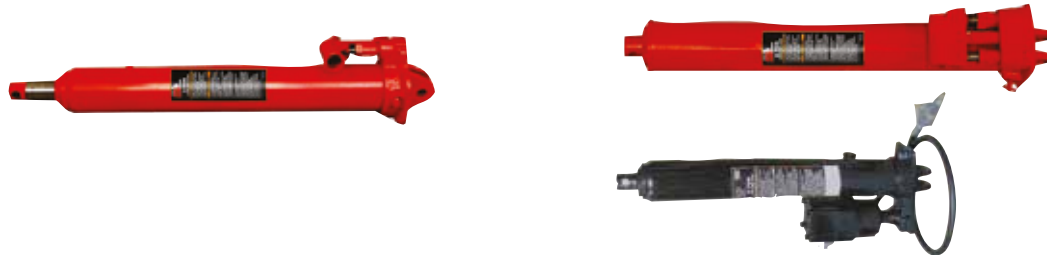

Č.p.	specifikace	zátěž	min.délka (mm)	max. délka (mm)	váha	
26911	Hydraulický válec, jednoduchá pumpa	5 000 kg	620	1100	12 kg	2
26912	Hydraulický válec, jednoduchá pumpa	8 000 kg	620	1100	13 kg	2
26914	Hydraulický válec, dvojitá pumpa	5 000 kg	620	1100	12 kg	2
26915	Hydraulický válec, dvojitá pumpa	8 000 kg	620	1100	14 kg	2



MYČKA SOUČÁSTEK

· pro běžné mytí předmětů (součástky, díly strojů apod.)



Č.p.	specifikace	objem vany	objem čistící kapaliny	Průtok	Max. teplota čistící kapaliny	váha	
26961	Myčka součástek	90 l	45 l	10-12 l/min.	50°C	25 kg	1
26963	Myčka součástek	180l	150 l	20 l/min	50°C	42 kg	1



SCEZOVACÍ NÁDOBA NA OLEJ



Č.p.	objem	max.tlak	váha	
26953	90 l	0,2 MPa	22 kg	1

ODSÁVAČKA VYJETÉHO OLEJE

- olej se z motoru vypouští do vypouštěcí vaničky, odkud stéká do zásobníku
- nádoba je navíc vybavena pneumatickou odsávačkou
- vyprazdňování zásobníku se provádí pneumaticky jeho připojením na stlačený vzduch



Č.p.	objem	max.tlak	váha	
26954	90 l	0,5 MPa	28 kg	1

STAHOVÁK NA LOŽISKA - DVOURAMENNÝ



Č.p.	max. průměr	hloubka	
23734	Ø 100 mm	50-95 mm	1
23735	Ø 150 mm	100-150 mm	1
23736	Ø 200 mm	110-190 mm	1

STAHOVÁK NA LOŽISKA - TŘÍRAMENNÝ



Č.p.	max. průměr	hloubka	
23730	Ø 100 mm	50-95 mm	12
23731	Ø 150 mm	100-150 mm	2
23732	Ø 200 mm	110-190 mm	2

HYDRAULICKÝ STAHOVÁK

- sada s hydraulickým stahovákem na ložiska, náboje kol, ozubená kola
- obsahuje hydraulický šroub, třmen, separátor, tažné šrouby + prodloužení
- v kovovém kufru



Č.p.	specifikace	zátěž	váha	
26891	Univerzální sada hydraulických stahováků	12 000 kg	18 kg	1

PÍSKOVACÍ KABINA 220 L



NÁHRADNÍ DÍLY K PÍSKOVACÍ KABINĚ

Č.p.	rozměry	
26973	rukavice	1
26974	trysky	1
26975	fólie 53,5 x 26 cm	1
26976	plexisklo 60 x 30 cm	1
26977	sklo 60 x 30 cm	1



Č.p.	spotřeba vzduchu	vnější rozměry	vnitřní rozměry	max.tlak	váha	
26972	420-710 l/min.	1500 x 830 x 630 mm	600 x 840 x 630 mm	8 bar	38 kg	1

VOZÍK NA NÁŘADÍ

FESTA®



Č.p.	Pojezdy zásuvek	Zásuvky	Celkové rozměry (mm)	
26986	kluzné	7	680 x 460 x 1020 mm	1

VOZÍK NA NÁŘADÍ

· horní skříňku lze uložit do sponního vozíku



Č.p.	specifikace	Pojezdy zásuvek	Zásuvky	Vnitřní rozměry zásuvek ŠxHxV	Celkové rozměry	Celková váha (kg)	
26985	horní skříňka	kluzné	3	151,5 x 225 x 40 mm	600 x 260 x 340 mm	11,5 kg	1
			2	511 x 225 x 40 mm			
	spodní skříňka	kluzné	1	511 x 225 x 85 mm	616 x 330 x 742 mm	16,4 kg kg	
			2	511 x 308 x 85 mm			

MAGNETICKÁ MISKA



NAPÍŇACÍ ZAŘÍZENÍ



Č.p.	vnitřní rozměry		Č.p.	vnitřní rozměry	
26996	200 x 20 mm	1	50035	2 t	6
			50036	4 t	4

POJÍZDNÉ KLEKÁTKO



Č.p. **37135**  1

MONTÁŽNÍ LEHÁTKO

· čalouněné pojízdné lehátko



Č.p. **26936** Specifikace **930 x 440 x 105 mm**  1

MONTÁŽNÍ LEHÁTKO

· plastové pojízdné lehátko s čalouněnou opěrkou hlavy
· přihrádky po stranách na odkládání náradí



Č.p. **26934** Specifikace **1030 x 450 x 105 mm**  1

MONTÁŽNÍ LEHÁTKO

· čalouněné pojízdné lehátko s naklápěcí opěrkou hlavy a postranními odkládacími přihrádkami na náradí



Č.p. **26938** Specifikace **1030 x 440 x 105 mm**  1

MONTÁŽNÍ SEDÁTKO

· čalouněné pojízdné sedátko s plastovou odkládací přihrádkou.



Č.p. **26988** Specifikace **360 x 365 x 365 mm**   1

STOJAN NA MOTORY - MODEL



Č.p. **26979**  1

ZVEDÁK MOTOCYKLŮ - MODEL



Č.p. **26997**  1

HYDRAULICKÝ MINI JEŘÁB - MODEL



Č.p. **26998**  1

číslo položky	str.	číslo položky	str.	číslo položky	str.	číslo položky	str.	číslo položky	str.	číslo položky	str.
10002	4 B	12050	9 B	13284	32 B	13462	11 B	14380	13 B	15535	18 B
10003	4 B	12110	9 B	13285	35 B	13463	11 B	14399	13 B	15540	18 B
10005	4 B	12120	9 B	13290	70 C	13464	11 B	14410	14 B	15615	18 B
10008	4 B	12130	9 B	13293	70 C	13465	11 B	14411	14 B	15620	18 B
10025	4 B	12150	9 B	13294	70 C	13466	11 B	14420	13 B	15625	18 B
10033	4 B	12210	9 B	13295	37 B	13467	11 B	14421	13 B	15630	18 B
10035	4 B	12220	9 B	13296	37 B	13468	11 B	14425	14 B	15710	18 B
10043	4 B	12230	9 B	13350	36 B	13469	11 B	14430	14 B	15715	18 B
10045	4 B	12250	9 B	13351	36 B	13470	11 B	14435	14 B	15720	18 B
10048	4 B	12433	9 B	13352	36 B	13471	11 B	14440	14 B	15725	18 B
10110	5 B	12435	9 B	13353	36 B	13472	11 B	14450	13 B	15730	18 B
10120	5 B	13010	10 B	13354	36 B	13473	11 B	14451	13 B	15735	18 B
10130	5 B	13020	10 B	13355	36 B	13500	8 B	14455	14 B	15740	18 B
10330	5 B	13021	10 B	13360	36 B	13501	8 B	14456	14 B	15810	19 B
10332	5 B	13022	10 B	13361	36 B	13502	8 B	14457	14 B	15812	19 B
10334	5 B	13023	10 B	13362	36 B	13503	8 B	14458	14 B	15815	19 B
10336	5 B	13030	10 B	13363	36 B	13504	8 B	14471	14 B	15818	19 B
10430	5 B	13111	10 B	13364	36 B	13505	8 B	14472	14 B	15820	19 B
10450	5 B	13120	10 B	13365	36 B	13506	8 B	14473	14 B	15825	19 B
10490	5 B	13205	35 B	13399	11 B	13507	8 B	14474	14 B	15830	19 B
10996	5 B	13210	10 B	13400	11 B	13508	8 B	14480	10 B	15850	19 B
10998	5 B	13211	10 B	13401	11 B	13509	8 B	14490	14 B	15853	19 B
10999	5 B	13212	35 B	13402	11 B	13510	8 B	14491	14 B	15855	19 B
11002	7 B	13214	34 B	13403	11 B	13511	8 B	14492	14 B	15860	19 B
11003	7 B	13216	34 B	13404	11 B	13512	8 B	14493	14 B	15870	19 B
11005	7 B	13217	34 B	13405	11 B	13513	8 B	14494	14 B	15880	19 B
11006	7 B	13218	34 B	13406	11 B	13514	8 B	15003	16 B	15885	225 E
11007	7 B	13219	34 B	13407	11 B	13515	8 B	15004	16 B	15886	225 E
11008	7 B	13220	10 B	13408	11 B	13516	8 B	15005	16 B	15886	345 F
11082	7 B	13222	34 B	13409	11 B	13517	8 B	15006	16 B	15887	225 E
11083	7 B	13223	34 B	13410	11 B	13518	8 B	15008	16 B	15887	345 F
11085	7 B	13224	34 B	13411	11 B	13519	8 B	15010	16 B	15888	225 E
11102	7 B	13225	34 B	13412	11 B	13520	8 B	15012	16 B	15888	345 F
11103	7 B	13226	34 B	13413	11 B	13521	8 B	15015	16 B	15889	225 E
11105	7 B	13227	34 B	13414	11 B	13522	8 B	15018	16 B	15904	20 B
11106	7 B	13228	34 B	13415	11 B	13523	8 B	15020	16 B	15906	20 B
11107	7 B	13229	34 B	13416	11 B	13524	8 B	15033	15 B	15908	20 B
11110	7 B	13230	34 B	13417	11 B	13525	8 B	15034	15 B	15910	20 B
11200	7 B	13231	34 B	13418	11 B	13526	8 B	15035	15 B	15912	20 B
11201	7 B	13235	34 B	13419	11 B	13527	8 B	15036	15 B	15915	20 B
11202	7 B	13236	34 B	13420	11 B	13528	8 B	15037	15 B	15920	20 B
11204	7 B	13237	34 B	13421	11 B	13529	8 B	15039	15 B	15954	20 B
11205	7 B	13238	34 B	13422	11 B	13530	8 B	15103	16 B	15956	20 B
11206	7 B	13240	33 B	13423	11 B	13531	8 B	15104	16 B	15958	20 B
11207	7 B	13241	33 B	13424	11 B	13532	8 B	15105	16 B	15960	20 B
11208	7 B	13242	33 B	13425	11 B	13533	8 B	15106	16 B	15962	20 B
11209	7 B	13243	33 B	13426	11 B	13534	8 B	15108	16 B	15965	20 B
11210	7 B	13244	33 B	13427	11 B	14001	12 B	15110	16 B	15970	20 B
11220	6 B	13245	33 B	13428	11 B	14002	12 B	15112	16 B	15980	22 B
11221	6 B	13249	36 B	13429	11 B	14003	12 B	15115	16 B	15981	22 B
11226	6 B	13250	36 B	13430	11 B	14004	12 B	15118	16 B	15983	9 B
11239	6 B	13251	36 B	13431	11 B	14006	12 B	15120	16 B	15985	9 B
11259	6 B	13252	36 B	13432	11 B	14007	12 B	15204	17 B	15988	9 B
11260	6 B	13253	36 B	13433	11 B	14008	12 B	15205	17 B	15989	9 B
11311	8 B	13254	36 B	13434	11 B	14009	12 B	15206	17 B	15990	22 B
11312	8 B	13255	37 B	13435	11 B	14010	10 B	15208	17 B	15991	22 B
11313	8 B	13256	37 B	13436	11 B	14011	10 B	15210	17 B	15992	22 B
11314	8 B	13257	37 B	13437	11 B	14012	10 B	15212	17 B	15993	22 B
11323	6 B	13258	37 B	13438	11 B	14013	12 B	15215	17 B	15996	19 B
11325	6 B	13259	37 B	13439	11 B	14015	10 B	15218	17 B	15997	19 B
11327	6 B	13260	33 B	13440	11 B	14017	10 B	15220	17 B	15998	19 B
11333	7 B	13261	33 B	13441	11 B	14019	10 B	15230	17 B	15999	19 B
11335	7 B	13262	32 B	13442	11 B	14025	14 B	15235	17 B	16002	136 D
11337	7 B	13263	32 B	13443	11 B	14030	10 B	15310	17 B	16003	136 D
11338	7 B	13264	32 B	13444	11 B	14035	12 B	15315	17 B	16004	137 D
11343	6 B	13265	32 B	13445	11 B	14040	12 B	15318	17 B	16005	137 D
11345	6 B	13266	32 B	13446	11 B	14045	12 B	15320	17 B	16006	137 D
11347	6 B	13268	32 B	13447	11 B	14060	13 B	15325	17 B	16010	137 D
11353	6 B	13269	32 B	13448	11 B	14070	13 B	15330	17 B	16010	137 D
11355	6 B	13270	32 B	13449	11 B	14075	13 B	15335	17 B	16011	136 D
11356	6 B	13271	32 B	13450	11 B	14080	12 B	15340	17 B	16011	136 D
11358	6 B	13272	32 B	13451	11 B	14090	14 B	15415	18 B	16011	137 D
11360	6 B	13273	33 B	13452	11 B	14091	14 B	15418	18 B	16012	136 D
11410	8 B	13274	33 B	13453	11 B	14220	13 B	15420	18 B	16012	136 D
11416	7 B	13275	33 B	13454	11 B	14225	13 B	15425	18 B	16012	137 D
11420	8 B	13276	33 B	13455	11 B	14230	13 B	15430	18 B	16013	137 D
11425	8 B	13277	33 B	13456	11 B	14235	13 B	15510	18 B	16013	137 D
11444	8 B	13278	32 B	13457	11 B	14240	13 B	15515	18 B	16014	137 D
11445	8 B	13279	32 B	13458	11 B	14250	13 B	15518	18 B	16016	137 D
12010	9 B	13280	32 B	13459	11 B	14350	13 B	15520	18 B	16017	137 D
12020	9 B	13281	35 B	13460	11 B	14360	13 B	15525	18 B	16019	136 D
12030	9 B	13282	35 B	13461	11 B	14370	13 B	15530	18 B	16021	143 D

REJSTRÍK POLOŽEK



číslo položky	str.	číslo položky	str.	číslo položky	str.	číslo položky	str.	číslo položky	str.	číslo položky	str.
16022	147 D	16147	140 D	17026	153 D	17128	42 C	17259	85 C	17422	63 C
16023	141 D	16150	138 D	17027	153 D	17130	42 C	17260	84 C	17427	64 C
16024	143 D	16151	138 D	17028	47 C	17133	42 C	17261	69 C	17450	69 C
16025	140 D	16198	150 D	17029	47 C	17135	42 C	17262	69 C	17451	69 C
16026	143 D	16199	150 D	17033	44 C	17137	42 C	17292	59 C	17455	64 C
16028	143 D	16201	147 D	17034	46 C	17138	42 C	17294	59 C	17456	64 C
16029	140 D	16209	149 D	17035	46 C	17140	40 C	17295	59 C	17460	66 C
16030	142 D	16210	148 D	17036	46 C	17141	40 C	17296	59 C	17461	66 C
16031	142 D	16211	148 D	17038	47 C	17142	40 C	17297	59 C	17462	66 C
16032	142 D	16212	147 D	17039	47 C	17145	40 C	17298	59 C	17463	66 C
16033	142 D	16218	148 D	17040	43 C	17146	40 C	17299	59 C	17464	66 C
16034	140 D	16219	148 D	17041	43 C	17148	40 C	17300	46 C	17465	66 C
16035	142 D	16220	148 D	17042	43 C	17155	49 C	17301	46 C	17466	66 C
16036	142 D	16221	148 D	17043	43 C	17156	49 C	17302	46 C	17467	66 C
16037	141 D	16222	149 D	17044	43 C	17158	50 C	17304	46 C	17468	66 C
16038	142 D	16223	149 D	17045	43 C	17159	50 C	17305	46 C	17469	66 C
16041	142 D	16224	149 D	17046	47 C	17160	50 C	17308	60 C	17470	66 C
16042	144 D	16225	147 D	17048	47 C	17165	49 C	17309	60 C	17471	66 C
16042	251 E	16226	149 D	17050	50 C	17167	49 C	17310	60 C	17472	66 C
16043	143 D	16227	149 D	17050	153 D	17169	49 C	17311	60 C	17473	66 C
16046	143 D	16228	149 D	17051	47 C	17170	49 C	17312	60 C	17475	67 C
16049	144 D	16229	147 D	17052	47 C	17175	49 C	17313	60 C	17476	67 C
16050	144 D	16230	147 D	17053	47 C	17177	49 C	17314	60 C	17480	66 C
16051	144 D	16231	99 C	17054	47 C	17180	42 C	17315	60 C	17481	66 C
16052	144 D	16231	147 D	17055	47 C	17181	42 C	17316	60 C	17482	66 C
16053	143 D	16232	42 C	17056	47 C	17182	152 D	17317	60 C	17483	66 C
16054	144 D	16232	150 D	17057	47 C	17183	152 D	17318	60 C	17484	66 C
16055	143 D	16234	147 D	17058	47 C	17185	50 C	17319	60 C	17485	66 C
16056	251 E	16235	148 D	17059	44 C	17186	49 C	17320	60 C	17486	66 C
16057	141 D	16236	148 D	17060	44 C	17187	113 C	17321	60 C	17487	65 C
16058	141 D	16281	151 D	17061	44 C	17188	113 C	17322	60 C	17488	65 C
16059	144 D	16282	151 D	17062	44 C	17189	113 C	17324	60 C	17489	65 C
16060	146 D	16300	154 D	17063	45 C	17190	43 C	17327	60 C	17490	65 C
16061	146 D	16301	154 D	17064	45 C	17191	43 C	17330	60 C	17491	65 C
16062	145 D	16303	154 D	17065	45 C	17192	43 C	17332	60 C	17492	65 C
16063	145 D	16304	154 D	17066	45 C	17193	43 C	17333	60 C	17493	65 C
16064	145 D	16310	154 D	17067	45 C	17197	66 C	17334	60 C	17494	65 C
16065	145 D	16310	154 D	17068	45 C	17198	66 C	17335	55 C	17495	65 C
16066	138 D	16311	154 D	17069	45 C	17199	66 C	17336	55 C	17496	65 C
16066	145 D	16311	154 D	17070	45 C	17200	66 C	17337	55 C	17501	68 C
16067	145 D	16311	154 D	17071	45 C	17201	66 C	17338	55 C	17506	67 C
16068	145 D	16312	154 D	17072	45 C	17202	66 C	17345	54 C	17508	67 C
16069	144 D	16312	154 D	17075	45 C	17203	69 C	17346	54 C	17512	67 C
16070	144 D	16315	153 D	17076	45 C	17204	69 C	17350	88 C	17526	67 C
16070	146 D	16315	153 D	17077	45 C	17205	69 C	17351	88 C	17528	67 C
16071	141 D	16320	154 D	17079	44 C	17206	69 C	17352	88 C	17532	67 C
16071	146 D	16401	50 C	17080	44 C	17208	55 C	17353	88 C	17533	67 C
16072	146 D	16405	50 C	17081	44 C	17210	51 C	17357	88 C	17534	67 C
16073	146 D	16406	50 C	17082	44 C	17211	51 C	17359	88 C	17539	67 C
16074	141 D	16407	50 C	17083	46 C	17212	52 C	17360	88 C	17548	65 C
16074	146 D	16408	50 C	17084	44 C	17213	52 C	17361	88 C	17549	65 C
16075	146 D	16420	50 C	17085	44 C	17214	52 C	17380	64 C	17550	65 C
16077	145 D	16990	151 D	17086	44 C	17215	52 C	17381	64 C	17551	65 C
16078	145 D	16990	306 F	17089	48 C	17216	53 C	17382	63 C	17552	65 C
16081	145 D	16991	151 D	17090	48 C	17217	53 C	17383	63 C	17553	65 C
16082	144 D	16991	306 F	17091	48 C	17218	53 C	17384	63 C	17554	65 C
16083	146 D	16998	137 D	17092	48 C	17219	53 C	17385	63 C	17555	65 C
16084	146 D	16999	137 D	17093	48 C	17220	55 C	17386	63 C	17556	65 C
16085	141 D	17001	41 C	17094	41 C	17222	55 C	17390	64 C	17557	65 C
16086	141 D	17002	41 C	17095	41 C	17224	55 C	17391	64 C	17558	65 C
16090	139 D	17003	41 C	17096	41 C	17225	54 C	17392	64 C	17559	65 C
16091	139 D	17004	41 C	17097	41 C	17226	54 C	17393	64 C	17560	65 C
16095	141 D	17005	41 C	17098	41 C	17227	54 C	17394	64 C	17561	65 C
16100	138 D	17006	41 C	17099	41 C	17229	56 C	17395	64 C	17562	65 C
16104	136 D	17007	41 C	17100	41 C	17230	57 C	17396	64 C	17563	65 C
16105	138 D	17008	41 C	17101	40 C	17231	57 C	17397	64 C	17564	65 C
16110	138 D	17009	41 C	17102	40 C	17233	57 C	17398	64 C	17565	65 C
16115	138 D	17010	41 C	17103	40 C	17234	57 C	17400	64 C	17566	65 C
16120	138 D	17011	41 C	17104	40 C	17235	58 C	17401	63 C	17567	65 C
16125	138 D	17012	44 C	17105	40 C	17236	58 C	17402	63 C	17568	65 C
16130	140 D	17013	44 C	17108	41 C	17237	58 C	17405	63 C	17569	65 C
16131	138 D	17014	44 C	17109	43 C	17238	56 C	17406	63 C	17570	65 C
16135	140 D	17015	46 C	17110	41 C	17238	85 C	17407	63 C	17571	65 C
16136	139 D	17016	46 C	17111	48 C	17240	59 C	17410	63 C	17572	65 C
16137	139 D	17017	46 C	17112	48 C	17241	59 C	17411	63 C	17573	65 C
16140	140 D	17019	46 C	17116	48 C	17242	59 C	17412	63 C	17574	65 C
16141	143 D	17020	47 C	17117	48 C	17243	59 C	17413	63 C	17575	65 C
16142	139 D	17021	47 C	17121	48 C	17244	59 C	17414	63 C	17576	65 C
16143	139 D	17022	47 C	17122	48 C	17245	56 C	17415	63 C	17577	65 C
16144	139 D	17023	46 C	17125	42 C	17247	85 C	17416	63 C	17578	65 C
16145	139 D	17024	41 C	17126	42 C	17250	55 C	17420	63 C	17579	65 C
16146	140 D	17025	43 C	17127	42 C	17255	55 C	17421	63 C	17580	65 C

číslo položky	str.	číslo položky	str.	číslo položky	str.	číslo položky	str.	číslo položky	str.	číslo položky	str.
17581	65 C	17762	66 C	17902	61 C	18212	71 C	18519	87 C	18750	79 C
17582	65 C	17766	66 C	17904	61 C	18215	71 C	18520	87 C	18751	79 C
17583	65 C	17769	66 C	17905	61 C	18216	71 C	18521	87 C	18753	79 C
17584	65 C	17788	66 C	17907	61 C	18301	75 C	18522	87 C	18755	79 C
17585	65 C	17789	66 C	17910	61 C	18302	75 C	18523	87 C	18760	79 C
17586	65 C	17795	66 C	17912	61 C	18303	75 C	18524	87 C	18761	79 C
17587	65 C	17806	66 C	17913	61 C	18304	75 C	18527	87 C	18762	79 C
17589	65 C	17810	60 C	17914	61 C	18310	71 C	18540	87 C	18763	79 C
17590	65 C	17811	60 C	17916	61 C	18311	71 C	18541	87 C	18764	79 C
17591	65 C	17820	60 C	17921	61 C	18312	71 C	18542	87 C	18765	79 C
17592	65 C	17821	60 C	17922	61 C	18313	71 C	18543	87 C	18766	79 C
17593	65 C	17822	60 C	17924	61 C	18321	71 C	18544	87 C	18767	79 C
17600	69 C	17823	60 C	17925	61 C	18322	71 C	18545	87 C	18768	79 C
17601	69 C	17824	60 C	17926	61 C	18340	73 C	18546	87 C	18769	79 C
17602	69 C	17825	60 C	17927	61 C	18350	72 C	18547	87 C	18770	79 C
17603	69 C	17826	60 C	17930	61 C	18351	72 C	18548	87 C	18771	79 C
17605	66 C	17827	60 C	17931	61 C	18352	72 C	18549	87 C	18772	79 C
17606	66 C	17828	60 C	17932	61 C	18353	72 C	18550	87 C	18775	79 C
17607	66 C	17829	60 C	17933	61 C	18354	72 C	18551	87 C	18776	79 C
17608	66 C	17830	60 C	17934	61 C	18355	72 C	18552	87 C	18777	79 C
17609	66 C	17831	60 C	17935	61 C	18356	72 C	18553	87 C	18795	81 C
17610	66 C	17832	60 C	17943	61 C	18357	72 C	18554	87 C	18796	81 C
17611	66 C	17835	61 C	17944	61 C	18358	72 C	18557	87 C	18797	81 C
17612	66 C	17836	61 C	17970	80 C	18359	72 C	18559	87 C	18798	81 C
17613	66 C	17837	61 C	17971	80 C	18360	72 C	18562	87 C	18799	81 C
17614	66 C	17838	61 C	17972	80 C	18400	75 C	18567	87 C	18800	80 C
17615	66 C	17839	61 C	17973	80 C	18401	75 C	18572	87 C	18801	80 C
17616	66 C	17840	61 C	17974	80 C	18402	73 C	18575	87 C	18802	80 C
17617	66 C	17841	61 C	17975	80 C	18403	73 C	18576	87 C	18803	80 C
17620	68 C	17842	61 C	17976	80 C	18404	73 C	18577	87 C	18804	80 C
17621	68 C	17843	61 C	17980	80 C	18408	77 C	18578	87 C	18805	80 C
17622	65 C	17844	61 C	17981	80 C	18409	77 C	18579	87 C	18806	80 C
17623	65 C	17845	61 C	17982	80 C	18410	74 C	18580	87 C	18807	80 C
17624	65 C	17846	61 C	17983	80 C	18411	74 C	18581	87 C	18810	80 C
17625	65 C	17847	61 C	18062	72 C	18413	74 C	18582	87 C	18811	80 C
17626	65 C	17848	61 C	18063	72 C	18415	77 C	18583	87 C	18812	80 C
17628	65 C	17849	61 C	18064	72 C	18416	77 C	18584	87 C	18813	80 C
17629	65 C	17850	61 C	18065	72 C	18417	77 C	18585	87 C	18814	80 C
17630	65 C	17851	61 C	18066	72 C	18418	75 C	18586	87 C	18815	80 C
17631	65 C	17852	61 C	18067	72 C	18419	77 C	18587	87 C	18816	80 C
17632	65 C	17853	61 C	18070	72 C	18420	77 C	18588	87 C	18817	80 C
17633	65 C	17854	61 C	18071	72 C	18421	84 C	18589	87 C	18820	80 C
17640	68 C	17855	61 C	18072	72 C	18422	73 C	18593	87 C	18821	80 C
17642	68 C	17856	61 C	18075	72 C	18423	74 C	18600	81 C	18822	80 C
17643	68 C	17860	60 C	18076	72 C	18424	73 C	18601	81 C	18823	80 C
17644	68 C	17861	60 C	18077	72 C	18425	76 C	18602	81 C	18824	80 C
17645	68 C	17862	60 C	18080	72 C	18426	74 C	18603	59 C	18825	80 C
17650	68 C	17863	60 C	18081	72 C	18430	84 C	18604	64 C	18826	80 C
17651	68 C	17864	60 C	18082	72 C	18431	77 C	18607	81 C	18827	80 C
17652	68 C	17865	60 C	18083	72 C	18433	76 C	18608	76 C	18828	80 C
17653	68 C	17866	60 C	18084	72 C	18435	76 C	18609	81 C	18829	80 C
17654	68 C	17867	60 C	18085	72 C	18437	74 C	18610	82 C	18830	80 C
17655	68 C	17868	60 C	18086	72 C	18440	84 C	18611	82 C	18831	80 C
17656	68 C	17869	60 C	18087	72 C	18450	76 C	18612	82 C	18832	80 C
17657	68 C	17870	60 C	18088	72 C	18451	76 C	18613	82 C	18835	80 C
17658	68 C	17871	60 C	18089	72 C	18455	72 C	18614	82 C	18836	80 C
17659	68 C	17872	60 C	18090	72 C	18456	72 C	18615	82 C	18837	80 C
17660	65 C	17873	60 C	18091	72 C	18460	72 C	18618	82 C	18838	80 C
17661	65 C	17874	60 C	18092	72 C	18466	87 C	18619	64 C	18839	80 C
17662	65 C	17875	60 C	18101	75 C	18468	87 C	18619	81 C	18840	80 C
17663	65 C	17876	60 C	18102	75 C	18476	87 C	18620	79 C	18841	80 C
17664	65 C	17877	60 C	18103	75 C	18477	87 C	18621	79 C	18842	80 C
17665	65 C	17878	60 C	18104	75 C	18490	86 C	18623	79 C	18843	80 C
17666	65 C	17879	60 C	18105	75 C	18491	86 C	18625	79 C	18844	80 C
17667	65 C	17880	60 C	18106	75 C	18492	86 C	18627	79 C	18845	80 C
17668	65 C	17881	60 C	18107	75 C	18493	86 C	18628	79 C	18846	80 C
17669	65 C	17882	60 C	18108	75 C	18494	88 C	18630	79 C	18847	80 C
17670	65 C	17883	60 C	18110	76 C	18495	88 C	18631	79 C	18850	80 C
17671	65 C	17884	60 C	18113	71 C	18496	86 C	18632	79 C	18851	80 C
17672	65 C	17885	60 C	18114	71 C	18497	86 C	18633	79 C	18852	80 C
17674	65 C	17886	60 C	18115	71 C	18498	86 C	18634	79 C	18853	80 C
17675	65 C	17887	60 C	18116	71 C	18499	88 C	18635	79 C	18855	80 C
17676	65 C	17888	60 C	18118	71 C	18500	86 C	18636	79 C	18856	80 C
17677	65 C	17889	60 C	18120	71 C	18508	87 C	18637	79 C	18860	80 C
17678	65 C	17890	60 C	18124	71 C	18510	87 C	18638	79 C	18861	80 C
17679	65 C	17891	60 C	18125	71 C	18511	87 C	18639	79 C	18862	80 C
17680	68 C	17892	60 C	18201	75 C	18512	87 C	18640	79 C	18863	80 C
17681	68 C	17895	61 C	18202	75 C	18513	87 C	18641	79 C	18864	80 C
17682	68 C	17896	61 C	18203	75 C	18514	87 C	18645	79 C	18865	80 C
17683	65 C	17897	61 C	18204	75 C	18515	87 C	18646	79 C	18866	80 C
17685	66 C	17898	61 C	18210	71 C	18516	87 C	18680	79 C	18867	80 C
17761	66 C	17900	61 C	18211	71 C	18518	87 C	18685	79 C	18868	81 C

REJSTRÍK POLOŽEK



číslo položky	str.	číslo položky	str.	číslo položky	str.	číslo položky	str.	číslo položky	str.	číslo položky	str.
18869	81 C	19061	90 C	19360	96 C	19481	173 D	19577	158 D	19645	158 D
18870	81 C	19062	91 C	19370	96 C	19482	173 D	19578	158 D	19646	158 D
18871	81 C	19063	91 C	19371	96 C	19483	173 D	19579	158 D	19647	158 D
18872	81 C	19064	90 C	19380	95 C	19485	172 D	19580	158 D	19648	158 D
18873	81 C	19065	91 C	19381	95 C	19486	172 D	19580	158 D	19649	158 D
18874	81 C	19066	90 C	19382	95 C	19487	172 D	19581	158 D	19650	158 D
18900	83 C	19067	90 C	19383	95 C	19490	99 C	19582	158 D	19650	158 D
18901	83 C	19068	90 C	19384	95 C	19491	99 C	19583	158 D	19651	158 D
18905	83 C	19069	90 C	19385	95 C	19492	99 C	19584	158 D	19652	158 D
18906	83 C	19070	90 C	19387	95 C	19493	99 C	19585	158 D	19653	158 D
18907	84 C	19071	90 C	19388	95 C	19494	99 C	19585	158 D	19654	158 D
18909	83 C	19074	89 C	19389	95 C	19495	99 C	19586	158 D	19655	158 D
18910	76 C	19075	89 C	19390	96 C	19496	99 C	19587	158 D	19656	158 D
18915	84 C	19076	89 C	19391	95 C	19497	99 C	19588	158 D	19657	158 D
18916	84 C	19077	89 C	19392	96 C	19498	99 C	19589	158 D	19658	158 D
18920	62 C	19081	89 C	19394	97 C	19499	99 C	19590	158 D	19659	158 D
18921	62 C	19082	89 C	19395	97 C	19501	99 C	19590	158 D	19660	158 D
18922	62 C	19083	89 C	19396	97 C	19502	99 C	19591	158 D	19661	158 D
18925	62 C	19084	89 C	19397	97 C	19510	100 C	19592	158 D	19662	158 D
18926	62 C	19085	89 C	19398	92 C	19515	100 C	19593	158 D	19663	158 D
18927	62 C	19086	89 C	19399	92 C	19520	100 C	19594	158 D	19664	158 D
18928	62 C	19088	89 C	19400	98 C	19530	158 D	19595	158 D	19665	158 D
18929	62 C	19090	89 C	19401	98 C	19530	158 D	19595	158 D	19669	158 D
18930	62 C	19092	89 C	19402	98 C	19531	158 D	19596	158 D	19670	159 D
18931	62 C	19095	89 C	19403	98 C	19532	158 D	19597	158 D	19671	159 D
18934	62 C	19096	89 C	19404	98 C	19533	158 D	19598	158 D	19672	159 D
18935	62 C	19097	89 C	19405	98 C	19534	158 D	19599	158 D	19673	159 D
18937	62 C	19098	89 C	19406	98 C	19535	158 D	19600	158 D	19673	159 D
18939	62 C	19100	91 C	19407	98 C	19535	158 D	19600	158 D	19674	159 D
18944	62 C	19106	89 C	19408	98 C	19536	158 D	19601	158 D	19675	159 D
18945	62 C	19108	89 C	19409	98 C	19537	158 D	19602	158 D	19676	159 D
18948	62 C	19109	89 C	19410	98 C	19538	158 D	19603	158 D	19677	159 D
18950	62 C	19110	100 C	19410	172 D	19539	158 D	19604	158 D	19678	159 D
18951	62 C	19115	92 C	19411	98 C	19540	158 D	19605	158 D	19678	159 D
18954	62 C	19115	116 C	19411	172 D	19540	158 D	19605	158 D	19679	159 D
18955	62 C	19124	92 C	19412	98 C	19541	158 D	19606	158 D	19680	159 D
18956	62 C	19136	92 C	19412	172 D	19542	158 D	19607	158 D	19681	159 D
18957	62 C	19148	92 C	19415	97 C	19543	158 D	19608	158 D	19682	159 D
18960	62 C	19149	92 C	19416	97 C	19544	158 D	19609	158 D	19683	159 D
18961	62 C	19150	91 C	19418	98 C	19545	158 D	19610	158 D	19683	159 D
18963	62 C	19151	90 C	19418	172 D	19545	158 D	19610	158 D	19684	159 D
18967	62 C	19200	93 C	19419	98 C	19546	158 D	19611	158 D	19685	159 D
18968	62 C	19202	93 C	19419	172 D	19547	158 D	19612	158 D	19686	159 D
18969	62 C	19208	94 C	19421	97 C	19548	158 D	19613	158 D	19687	159 D
18970	62 C	19209	94 C	19422	97 C	19549	158 D	19614	158 D	19688	159 D
18971	62 C	19211	94 C	19423	97 C	19550	158 D	19615	158 D	19688	159 D
18972	62 C	19245	93 C	19424	97 C	19550	158 D	19615	158 D	19689	159 D
18993	82 C	19246	93 C	19425	97 C	19551	158 D	19616	158 D	19690	159 D
18994	82 C	19247	93 C	19426	97 C	19552	158 D	19617	158 D	19691	159 D
19001	90 C	19248	93 C	19427	97 C	19552	158 D	19618	158 D	19692	159 D
19002	90 C	19249	93 C	19429	172 D	19553	158 D	19619	158 D	19693	159 D
19003	90 C	19251	94 C	19430	92 C	19554	158 D	19620	158 D	19693	159 D
19004	90 C	19252	94 C	19431	92 C	19555	158 D	19620	158 D	19694	159 D
19005	90 C	19253	94 C	19432	92 C	19555	158 D	19621	158 D	19695	159 D
19006	90 C	19254	93 C	19433	92 C	19556	158 D	19622	158 D	19695	159 D
19008	90 C	19255	93 C	19434	92 C	19557	158 D	19623	158 D	19696	159 D
19010	90 C	19265	93 C	19435	92 C	19558	158 D	19624	158 D	19697	159 D
19015	90 C	19270	93 C	19436	98 C	19558	158 D	19625	158 D	19698	159 D
19020	90 C	19271	93 C	19436	172 D	19559	158 D	19625	158 D	19698	159 D
19021	90 C	19272	93 C	19440	92 C	19560	158 D	19626	158 D	19699	159 D
19022	90 C	19290	93 C	19441	92 C	19560	158 D	19627	158 D	19700	159 D
19023	90 C	19294	93 C	19442	92 C	19561	158 D	19628	158 D	19701	159 D
19024	90 C	19295	93 C	19443	92 C	19562	158 D	19629	158 D	19701	159 D
19025	90 C	19297	94 C	19450	99 C	19562	158 D	19630	158 D	19702	159 D
19026	90 C	19301	96 C	19451	99 C	19563	158 D	19630	158 D	19703	159 D
19028	90 C	19303	91 C	19455	99 C	19564	158 D	19631	158 D	19703	159 D
19030	90 C	19306	95 C	19457	99 C	19565	158 D	19632	158 D	19704	159 D
19031	90 C	19308	95 C	19458	100 C	19565	158 D	19633	158 D	19705	159 D
19032	90 C	19310	95 C	19459	100 C	19566	158 D	19634	158 D	19705	159 D
19034	90 C	19312	95 C	19460	98 C	19567	158 D	19635	158 D	19706	159 D
19036	90 C	19314	95 C	19462	97 C	19568	158 D	19635	158 D	19707	159 D
19050	90 C	19326	96 C	19463	97 C	19568	158 D	19636	158 D	19708	159 D
19051	91 C	19328	96 C	19464	97 C	19569	158 D	19637	158 D	19708	159 D
19052	91 C	19330	96 C	19465	97 C	19570	158 D	19638	158 D	19709	159 D
19053	90 C	19332	96 C	19469	97 C	19570	158 D	19639	158 D	19710	159 D
19054	90 C	19335	96 C	19470	98 C	19571	158 D	19640	158 D	19711	159 D
19055	90 C	19337	96 C	19472	173 D	19572	158 D	19640	158 D	19711	159 D
19056	90 C	19340	95 C	19473	173 D	19573	158 D	19641	158 D	19712	159 D
19057	90 C	19344	96 C	19474	173 D	19574	158 D	19642	158 D	19713	159 D
19058	90 C	19354	96 C	19477	173 D	19575	158 D	19643	158 D	19713	159 D
19059	90 C	19356	96 C	19478	173 D	19575	158 D	19644	158 D	19714	159 D
19060	91 C	19357	96 C	19480	173 D	19576	158 D	19645	158 D	19715	159 D

číslo položky	str.	číslo položky	str.	číslo položky	str.	číslo položky	str.	číslo položky	str.	číslo položky	str.
19716	159 D	19783	159 D	20411	160 D	20740	174 D	20905	174 D	21211	203 D
19717	159 D	19784	159 D	20412	160 D	20741	174 D	20910	174 D	21212	203 D
19718	159 D	19785	159 D	20413	160 D	20744	168 D	20911	174 D	21215	203 D
19718	159 D	19786	159 D	20414	160 D	20744	178 D	20912	174 D	21218	203 D
19719	159 D	19786	159 D	20415	160 D	20745	178 D	20913	174 D	21219	203 D
19720	159 D	19787	159 D	20416	160 D	20748	166 D	20915	174 D	21220	203 D
19721	159 D	19788	159 D	20417	160 D	20749	166 D	20916	174 D	21223	203 D
19722	159 D	19789	159 D	20418	160 D	20750	166 D	20917	174 D	21224	203 D
19723	159 D	19790	159 D	20419	160 D	20751	166 D	20918	174 D	21301	205 D
19723	159 D	19791	159 D	20420	160 D	20752	166 D	20919	174 D	21303	205 D
19724	159 D	19792	159 D	20421	160 D	20753	166 D	20920	174 D	21306	207 D
19725	159 D	19793	159 D	20422	160 D	20754	166 D	20921	174 D	21308	207 D
19726	159 D	19794	159 D	20423	160 D	20755	166 D	20922	174 D	21311	203 D
19727	159 D	19795	159 D	20424	160 D	20756	166 D	20923	174 D	21312	203 D
19728	159 D	19796	159 D	20425	160 D	20757	166 D	20924	174 D	21315	203 D
19728	159 D	19797	159 D	20426	160 D	20758	166 D	20936	168 D	21318	203 D
19729	159 D	19798	159 D	20427	160 D	20759	166 D	20937	168 D	21323	203 D
19730	159 D	19799	159 D	20428	160 D	20760	166 D	20938	168 D	21324	203 D
19731	159 D	19800	159 D	20429	160 D	20761	166 D	20939	168 D	21325	203 D
19732	159 D	19801	159 D	20430	160 D	20762	166 D	20940	168 D	21326	203 D
19733	159 D	19802	159 D	20450	175 D	20764	166 D	20941	168 D	21410	204 D
19733	159 D	19841	160 D	20460	175 D	20765	166 D	20942	168 D	21411	204 D
19734	159 D	19842	160 D	20487	163 D	20766	166 D	20943	168 D	21412	204 D
19735	159 D	19845	160 D	20488	163 D	20767	166 D	20944	168 D	21415	204 D
19736	159 D	19885	160 D	20489	163 D	20768	166 D	20945	168 D	21418	204 D
19737	159 D	19895	160 D	20490	163 D	20769	166 D	20946	168 D	21423	204 D
19738	159 D	20210	175 D	20491	163 D	20770	166 D	20947	168 D	21424	204 D
19738	159 D	20220	160 D	20492	163 D	20771	166 D	20948	168 D	21425	205 D
19739	159 D	20225	160 D	20493	163 D	20772	166 D	20949	168 D	21426	205 D
19740	159 D	20230	160 D	20494	163 D	20773	166 D	20950	167 D	21427	205 D
19741	159 D	20235	160 D	20495	163 D	20774	166 D	20952	167 D	21428	205 D
19742	159 D	20240	160 D	20496	163 D	20775	166 D	20954	168 D	21430	205 D
19743	159 D	20245	160 D	20510	167 D	20776	166 D	20956	168 D	21431	205 D
19743	159 D	20250	160 D	20511	167 D	20777	166 D	20957	174 D	21432	205 D
19744	159 D	20255	160 D	20512	167 D	20778	166 D	20958	174 D	21440	174 D
19745	159 D	20260	160 D	20513	167 D	20779	166 D	20960	178 D	21441	174 D
19746	159 D	20270	160 D	20514	167 D	20780	166 D	20961	178 D	21442	174 D
19747	159 D	20280	160 D	20515	167 D	20781	166 D	20963	178 D	21443	174 D
19748	159 D	20290	160 D	20516	167 D	20782	166 D	20965	178 D	21444	174 D
19748	159 D	20296	160 D	20520	167 D	20783	166 D	20966	178 D	21445	174 D
19749	159 D	20300	162 D	20521	167 D	20784	166 D	20967	68 C	21446	174 D
19750	159 D	20305	162 D	20522	167 D	20785	166 D	20968	68 C	21450	175 D
19751	159 D	20310	162 D	20523	167 D	20786	166 D	20969	68 C	21451	175 D
19752	159 D	20311	162 D	20524	167 D	20787	166 D	20970	178 D	21452	175 D
19753	159 D	20315	162 D	20525	167 D	20788	166 D	20971	178 D	21453	176 D
19753	159 D	20316	161 D	20526	167 D	20789	166 D	20972	178 D	21454	176 D
19754	159 D	20317	161 D	20673	166 D	20790	166 D	20973	178 D	21530	175 D
19755	159 D	20320	162 D	20674	166 D	20791	166 D	20980	174 D	21540	176 D
19756	159 D	20321	162 D	20675	166 D	20792	166 D	20981	174 D	21541	176 D
19757	159 D	20333	161 D	20676	166 D	20793	166 D	20982	174 D	21701	186 D
19758	159 D	20334	161 D	20677	166 D	20794	166 D	20983	174 D	21702	186 D
19758	159 D	20335	161 D	20678	166 D	20795	166 D	20984	174 D	21703	186 D
19759	159 D	20336	161 D	20680	166 D	20796	166 D	20990	168 D	21704	186 D
19760	159 D	20337	161 D	20682	166 D	20797	166 D	20991	168 D	21705	186 D
19761	159 D	20338	161 D	20684	166 D	20798	166 D	20992	168 D	21706	186 D
19762	159 D	20350	173 D	20685	166 D	20799	166 D	20999	167 D	21709	186 D
19763	159 D	20360	154 D	20686	166 D	20805	167 D	21010	204 D	21715	186 D
19763	159 D	20361	154 D	20687	166 D	20820	167 D	21011	204 D	21716	186 D
19764	159 D	20363	49 C	20688	166 D	20825	166 D	21012	204 D	21717	186 D
19765	159 D	20365	178 D	20690	166 D	20855	166 D	21015	204 D	21718	186 D
19766	159 D	20379	170 D	20691	166 D	20861	166 D	21018	204 D	21719	186 D
19767	159 D	20380	162 D	20692	166 D	20862	166 D	21023	204 D	21720	186 D
19768	159 D	20381	177 D	20694	166 D	20870	166 D	21110	204 D	21721	186 D
19768	159 D	20385	165 D	20696	166 D	20871	166 D	21111	204 D	21724	186 D
19769	159 D	20386	165 D	20697	166 D	20872	166 D	21112	204 D	21732	186 D
19770	159 D	20387	165 D	20698	166 D	20873	166 D	21115	204 D	21734	186 D
19771	159 D	20390	165 D	20724	174 D	20874	166 D	21118	204 D	21735	186 D
19772	159 D	20391	165 D	20725	174 D	20875	166 D	21123	204 D	21736	186 D
19772	159 D	20395	165 D	20726	174 D	20876	166 D	21130	204 D	21737	186 D
19773	159 D	20396	165 D	20727	174 D	20877	166 D	21135	204 D	21740	186 D
19774	159 D	20397	165 D	20728	174 D	20878	166 D	21140	204 D	21741	186 D
19775	159 D	20400	160 D	20729	174 D	20879	166 D	21150	204 D	21742	186 D
19776	159 D	20401	160 D	20730	174 D	20880	166 D	21180	204 D	21743	186 D
19776	159 D	20402	160 D	20731	174 D	20881	166 D	21190	204 D	21744	186 D
19777	159 D	20403	160 D	20732	174 D	20890	167 D	21192	207 D	21750	186 D
19778	159 D	20404	160 D	20733	174 D	20891	167 D	21194	207 D	21751	186 D
19779	159 D	20405	160 D	20734	174 D	20895	167 D	21195	205 D	21752	186 D
19780	159 D	20406	160 D	20735	174 D	20896	174 D	21200	203 D	21753	186 D
19781	159 D	20407	160 D	20736	174 D	20897	174 D	21201	203 D	21754	186 D
19781	159 D	20408	160 D	20737	174 D	20898	174 D	21203	203 D	21780	208 D
19782	159 D	20409	160 D	20738	174 D	20899	174 D	21204	203 D	21781	208 D
19783	159 D	20410	160 D	20739	174 D	20901	175 D	21210	203 D	21782	208 D

REJSTRÍK POLOŽEK

číslo položky	str.	číslo položky	str.	číslo položky	str.	číslo položky	str.	číslo položky	str.	číslo položky	str.
21783	208 D	22018	181 D	22102	187 D	22207	189 D	22515	157 D	23291	363 G
21784	208 D	22019	181 D	22103	187 D	22208	189 D	22520	157 D	23292	363 G
21786	208 D	22020	181 D	22104	187 D	22209	189 D	22525	157 D	23296	363 G
21787	208 D	22021	181 D	22105	187 D	22211	206 D	22530	157 D	23297	363 G
21788	208 D	22022	181 D	22106	187 D	22212	206 D	22532	157 D	23310	361 G
21789	208 D	22023	180 D	22107	187 D	22215	206 D	22535	157 D	23311	361 G
21790	208 D	22024	180 D	22108	187 D	22216	206 D	22540	157 D	23312	361 G
21792	208 D	22025	180 D	22109	187 D	22217	206 D	22542	157 D	23390	363 G
21793	208 D	22026	181 D	22110	187 D	22218	206 D	22545	157 D	23391	363 G
21794	208 D	22027	181 D	22111	187 D	22219	206 D	22548	157 D	23400	109 C
21795	208 D	22028	181 D	22112	187 D	22220	206 D	22550	157 D	23401	109 C
21796	208 D	22029	181 D	22113	187 D	22222	206 D	22555	157 D	23402	109 C
21798	184 D	22030	181 D	22115	187 D	22224	206 D	22560	157 D	23406	109 C
21798	208 D	22031	181 D	22116	187 D	22225	206 D	22565	157 D	23407	109 C
21800	209 D	22032	181 D	22117	187 D	22230	207 D	22568	157 D	23410	108 C
21801	209 D	22033	182 D	22120	188 D	22232	207 D	22570	157 D	23411	108 C
21802	209 D	22034	182 D	22121	188 D	22234	207 D	22575	157 D	23412	108 C
21810	185 D	22035	182 D	22122	188 D	22236	207 D	22580	157 D	23415	108 C
21811	185 D	22036	182 D	22123	188 D	22238	207 D	22585	157 D	23416	108 C
21812	185 D	22037	180 D	22124	188 D	22240	206 D	22590	157 D	23417	108 C
21813	185 D	22038	180 D	22125	188 D	22242	206 D	22595	157 D	23420	109 C
21814	185 D	22039	180 D	22126	188 D	22244	206 D	22600	157 D	23506	108 C
21831	185 D	22040	180 D	22129	188 D	22246	206 D	22602	157 D	23507	108 C
21832	185 D	22041	183 D	22130	188 D	22248	206 D	22605	157 D	23508	108 C
21834	185 D	22042	183 D	22132	188 D	22251	206 D	22610	157 D	23515	108 C
21850	187 D	22043	183 D	22133	188 D	22252	206 D	22615	157 D	23520	108 C
21851	187 D	22044	183 D	22134	188 D	22253	206 D	22620	157 D	23525	108 C
21852	187 D	22045	185 D	22135	343 F	22254	206 D	22625	157 D	23530	108 C
21853	187 D	22046	185 D	22136	343 F	22255	206 D	22630	157 D	23531	108 C
21854	187 D	22047	185 D	22137	343 F	22258	206 D	22701	183 D	23551	108 C
21855	187 D	22048	185 D	22138	343 F	22259	206 D	22702	183 D	23560	107 C
21856	187 D	22049	185 D	22140	208 D	22263	206 D	22703	183 D	23561	107 C
21857	187 D	22050	185 D	22141	208 D	22264	206 D	22704	183 D	23562	107 C
21858	187 D	22051	185 D	22142	208 D	22266	206 D	22705	183 D	23563	107 C
21859	187 D	22052	185 D	22143	208 D	22270	206 D	22706	183 D	23564	107 C
21860	187 D	22053	185 D	22145	208 D	22273	206 D	22707	183 D	23565	107 C
21861	187 D	22054	185 D	22146	208 D	22274	206 D	23000	360 G	23566	107 C
21862	187 D	22055	185 D	22147	208 D	22275	206 D	23001	360 G	23570	107 C
21863	187 D	22056	185 D	22148	208 D	22277	206 D	23005	362 G	23571	107 C
21864	187 D	22057	185 D	22150	208 D	22280	206 D	23006	362 G	23572	107 C
21900	179 D	22058	181 D	22151	208 D	22281	206 D	23010	362 G	23573	107 C
21901	179 D	22059	181 D	22155	208 D	22285	206 D	23020	362 G	23574	107 C
21902	179 D	22060	183 D	22156	208 D	22286	206 D	23025	362 G	23585	108 C
21903	179 D	22061	183 D	22158	182 D	22294	207 D	23030	362 G	23587	108 C
21904	179 D	22062	183 D	22159	182 D	22300	191 D	23035	362 G	23589	108 C
21905	179 D	22063	183 D	22160	185 D	22301	191 D	23040	362 G	23591	108 C
21906	179 D	22064	183 D	22161	185 D	22302	191 D	23050	362 G	23600	108 C
21907	180 D	22065	184 D	22162	185 D	22303	191 D	23060	362 G	23601	108 C
21908	180 D	22066	184 D	22163	185 D	22305	191 D	23070	362 G	23602	108 C
21909	180 D	22067	186 D	22164	185 D	22307	191 D	23125	361 G	23605	108 C
21910	180 D	22068	184 D	22165	185 D	22309	191 D	23130	361 G	23620	108 C
21911	180 D	22069	184 D	22166	185 D	22310	191 D	23135	361 G	23625	108 C
21912	180 D	22070	184 D	22167	185 D	22311	191 D	23140	361 G	23626	108 C
21913	180 D	22071	184 D	22168	185 D	22312	191 D	23150	361 G	23628	108 C
21914	180 D	22072	184 D	22169	185 D	22313	191 D	23160	361 G	23630	108 C
21920	179 D	22073	183 D	22170	190 D	22314	191 D	23211	361 G	23632	108 C
21925	179 D	22074	183 D	22171	190 D	22315	191 D	23212	361 G	23650	109 C
21926	179 D	22075	186 D	22172	190 D	22317	191 D	23213	361 G	23660	109 C
21930	181 D	22076	186 D	22173	190 D	22318	191 D	23214	361 G	23670	107 C
21931	181 D	22077	186 D	22174	190 D	22319	191 D	23215	361 G	23671	107 C
21935	181 D	22078	182 D	22178	189 D	22320	191 D	23220	361 G	23672	107 C
21936	181 D	22079	182 D	22180	189 D	22322	191 D	23225	361 G	23673	107 C
21937	181 D	22080	182 D	22181	189 D	22324	191 D	23232	361 G	23674	107 C
21940	181 D	22081	182 D	22182	189 D	22326	191 D	23240	361 G	23675	107 C
21941	181 D	22082	182 D	22183	189 D	22328	191 D	23250	361 G	23676	107 C
22001	179 D	22083	184 D	22184	189 D	22329	191 D	23260	361 G	23677	107 C
22002	179 D	22084	184 D	22185	189 D	22332	191 D	23261	361 G	23678	107 C
22003	179 D	22085	184 D	22186	189 D	22333	191 D	23262	361 G	23679	107 C
22004	180 D	22086	182 D	22188	190 D	22335	191 D	23263	361 G	23680	107 C
22005	180 D	22087	183 D	22189	190 D	22337	191 D	23264	361 G	23681	107 C
22006	180 D	22088	184 D	22190	190 D	22340	191 D	23265	361 G	23682	107 C
22007	179 D	22090	184 D	22195	190 D	22343	191 D	23266	361 G	23683	107 C
22008	179 D	22091	184 D	22197	190 D	22345	191 D	23270	360 G	23684	107 C
22009	179 D	22092	184 D	22198	190 D	22350	191 D	23273	361 G	23685	107 C
22010	179 D	22093	184 D	22199	190 D	22351	191 D	23274	361 G	23730	113 C
22011	179 D	22095	184 D	22200	170 D	22355	191 D	23275	361 G	23730	401 H
22012	180 D	22096	185 D	22201	170 D	22357	191 D	23281	363 G	23731	113 C
22013	180 D	22097	185 D	22202	190 D	22365	191 D	23282	363 G	23731	401 H
22014	180 D	22098	185 D	22203	190 D	22370	191 D	23284	363 G	23732	113 C
22015	180 D	22099	185 D	22204	190 D	22398	191 D	23287	362 G	23732	401 H
22016	180 D	22100	187 D	22205	190 D	22399	191 D	23288	362 G	23734	113 C
22017	180 D	22101	187 D	22206	189 D	22510	157 D	23290	363 G	23734	401 H

číslo položky	str.	číslo položky	str.	číslo položky	str.	číslo položky	str.	číslo položky	str.	číslo položky	str.
23735	113 C	23987	112 C	24144	199 D	24511	103 C	24731	168 D	25170	285 E
23735	401 H	23988	112 C	24145	199 D	24515	103 C	24732	168 D	25171	285 E
23736	113 C	23989	112 C	24147	199 D	24516	103 C	24735	170 D	25179	284 E
23736	401 H	24000	111 C	24148	199 D	24517	103 C	24736	170 D	25180	284 E
23760	102 C	24001	111 C	24149	199 D	24518	104 C	24737	170 D	25181	284 E
23761	102 C	24002	111 C	24150	200 D	24519	104 C	24738	170 D	25182	284 E
23762	102 C	24005	111 C	24151	200 D	24520	103 C	24739	170 D	25183	284 E
23763	102 C	24006	111 C	24152	201 D	24521	104 C	24740	170 D	25184	284 E
23764	102 C	24007	110 C	24152	301 F	24522	104 C	24741	170 D	25186	284 E
23800	102 C	24010	110 C	24153	197 D	24530	105 C	24743	170 D	25188	284 E
23810	370 G	24015	111 C	24154	200 D	24531	105 C	24745	169 D	25189	284 E
23814	370 G	24017	111 C	24155	202 D	24532	105 C	24746	170 D	25190	284 E
23816	370 G	24020	111 C	24156	202 D	24533	105 C	24747	169 D	25195	284 E
23818	370 G	24030	111 C	24158	202 D	24534	105 C	24748	170 D	25206	284 E
23820	370 G	24035	112 C	24159	188 D	24535	105 C	24749	170 D	25212	284 E
23824	370 G	24036	112 C	24159	202 D	24536	105 C	24750	164 D	25215	284 E
23826	370 G	24038	112 C	24160	196 D	24537	105 C	24751	164 D	25220	284 E
23828	370 G	24039	112 C	24161	196 D	24538	105 C	24755	176 D	25224	284 E
23830	370 G	24040	112 C	24162	196 D	24539	105 C	24756	176 D	25230	284 E
23840	307 F	24041	112 C	24163	196 D	24540	105 C	24757	169 D	25240	284 E
23845	306 F	24042	112 C	24164	196 D	24541	105 C	24758	169 D	25248	284 E
23846	306 F	24043	112 C	24165	196 D	24542	105 C	24759	169 D	25260	284 E
23847	306 F	24045	193 D	24166	196 D	24543	105 C	24760	171 D	25296	284 E
23850	370 G	24050	195 D	24167	196 D	24545	105 C	24761	171 D	25350	284 E
23854	370 G	24055	192 D	24168	196 D	24546	105 C	24762	171 D	25365	285 E
23856	370 G	24055	249 E	24169	196 D	24547	105 C	24763	171 D	25366	285 E
23858	370 G	24060	192 D	24170	198 D	24550	105 C	24764	171 D	25367	285 E
23860	370 G	24061	192 D	24171	199 D	24551	105 C	24765	171 D	25368	285 E
23864	370 G	24062	192 D	24173	200 D	24552	105 C	24766	171 D	25369	284 E
23865	370 G	24063	192 D	24174	202 D	24553	105 C	24767	171 D	25370	284 E
23866	370 G	24064	192 D	24175	202 D	24555	105 C	24768	171 D	25371	284 E
23868	370 G	24065	192 D	24176	202 D	24556	105 C	24769	171 D	25372	284 E
23870	370 G	24066	192 D	24177	202 D	24557	105 C	24770	170 D	25373	284 E
23880	370 G	24067	192 D	24178	202 D	24558	105 C	24771	170 D	25374	284 E
23882	370 G	24068	192 D	24180	197 D	24560	105 C	24772	170 D	25376	284 E
23884	370 G	24069	192 D	24181	202 D	24561	105 C	24773	170 D	25378	284 E
23904	102 C	24070	192 D	24185	196 D	24562	105 C	24774	170 D	25379	284 E
23906	102 C	24071	192 D	24186	196 D	24565	106 C	24780	171 D	25380	284 E
23908	102 C	24072	192 D	24187	196 D	24567	105 C	24781	171 D	25400	285 E
23910	102 C	24073	192 D	24188	196 D	24568	105 C	24782	171 D	25410	285 E
23912	102 C	24074	192 D	24189	196 D	24569	105 C	24783	171 D	26021	31 B
23914	102 C	24075	192 D	24190	188 D	24570	106 C	24784	171 D	26021	123 C
23920	102 C	24076	192 D	24190	202 D	24571	106 C	24785	171 D	26028	22 B
23922	102 C	24077	192 D	24192	196 D	24572	106 C	24786	171 D	26037	29 B
23923	101 C	24078	192 D	24195	196 D	24573	106 C	24787	171 D	26205	22 B
23924	101 C	24080	193 D	24196	196 D	24574	106 C	24788	171 D	26215	21 B
23925	101 C	24081	193 D	24197	196 D	24575	106 C	24789	171 D	26216	21 B
23927	101 C	24082	193 D	24212	374 G	24577	106 C	24790	171 D	26217	21 B
23928	102 C	24083	193 D	24225	374 G	24578	106 C	24791	171 D	26218	21 B
23930	106 C	24084	193 D	24250	374 G	24580	105 C	24792	171 D	26260	26 B
23931	106 C	24085	193 D	24255	374 G	24581	105 C	24793	171 D	26343	25 B
23932	106 C	24086	193 D	24258	374 G	24582	105 C	24794	171 D	26395	29 B
23934	106 C	24087	193 D	24260	374 G	24583	105 C	24795	171 D	26429	27 B
23935	106 C	24098	193 D	24301	194 D	24584	105 C	24796	171 D	26430	27 B
23936	106 C	24099	193 D	24302	194 D	24690	178 D	24798	171 D	26431	27 B
23945	101 C	24100	197 D	24303	194 D	24691	178 D	25001	285 E	26440	30 B
23950	112 C	24102	197 D	24304	194 D	24695	178 D	25002	285 E	26441	30 B
23951	112 C	24103	197 D	24305	194 D	24700	171 D	25003	285 E	26460	23 B
23952	112 C	24104	197 D	24306	194 D	24701	171 D	25004	285 E	26464	23 B
23953	112 C	24108	196 D	24308	195 D	24702	171 D	25005	285 E	26479	25 B
23954	112 C	24109	197 D	24310	195 D	24703	171 D	25006	284 E	26493	31 B
23955	112 C	24110	198 D	24312	195 D	24704	171 D	25009	284 E	26495	31 B
23960	102 C	24111	198 D	24313	195 D	24705	171 D	25012	284 E	26520	24 B
23961	102 C	24118	197 D	24314	196 D	24706	177 D	25015	284 E	26521	24 B
23962	102 C	24119	197 D	24315	195 D	24712	177 D	25016	284 E	26523	28 B
23963	102 C	24120	196 D	24410	164 D	24713	177 D	25020	284 E	26524	29 B
23964	102 C	24121	198 D	24411	164 D	24714	177 D	25024	284 E	26526	30 B
23965	102 C	24122	198 D	24419	164 D	24715	177 D	25025	284 E	26527	23 B
23966	102 C	24124	198 D	24420	164 D	24716	177 D	25030	284 E	26528	26 B
23967	102 C	24125	198 D	24422	164 D	24717	169 D	25040	284 E	26700	398 H
23970	112 C	24126	198 D	24425	164 D	24718	169 D	25048	284 E	26701	398 H
23971	112 C	24128	200 D	24429	164 D	24719	169 D	25060	284 E	26702	398 H
23972	112 C	24130	199 D	24432	164 D	24720	177 D	25096	284 E	26705	288 E
23973	112 C	24131	199 D	24435	164 D	24721	177 D	25150	284 E	26705	398 H
23974	112 C	24133	199 D	24437	164 D	24722	177 D	25153	284 E	26706	288 E
23975	112 C	24135	200 D	24444	164 D	24723	169 D	25155	284 E	26706	398 H
23976	112 C	24136	200 D	24451	164 D	24725	169 D	25160	285 E	26707	288 E
23977	112 C	24137	200 D	24457	164 D	24726	169 D	25162	285 E	26707	398 H
23978	112 C	24140	200 D	24464	164 D	24727	259 E	25163	285 E	26720	288 E
23979	112 C	24141	200 D	24476	164 D	24728	259 E	25164	285 E	26720	398 H
23985	112 C	24142	200 D	24483	164 D	24729	259 E	25167	285 E	26721	288 E
23986	112 C	24143	199 D	24510	103 C	24730	168 D	25169	285 E	26721	398 H

REJSTRÍK POLOŽEK



číslo položky	str.	číslo položky	str.	číslo položky	str.	číslo položky	str.	číslo položky	str.	číslo položky	str.
26722	288 E	31008	213 E	31501	218 E	32226	220 E	33201	389 G	34154	226 E
26722	398 H	31009	213 E	31502	218 E	32234	220 E	33202	389 G	34155	226 E
26775	260 E	31011	213 E	31503	218 E	32240	220 E	33202	389 G	34156	226 E
26780	267 E	31021	213 E	31505	217 E	32265	233 E	33203	389 G	34157	226 E
26781	267 E	31031	213 E	31506	217 E	32268	233 E	33203	389 G	34158	226 E
26782	267 E	31041	213 E	31507	217 E	32269	233 E	33205	389 G	34159	226 E
26783	267 E	31051	213 E	31510	216 E	32270	233 E	33205	389 G	34160	226 E
26800	394 H	31052	214 E	31511	216 E	32273	233 E	33206	389 G	34167	232 E
26801	394 H	31053	213 E	31512	216 E	32283	233 E	33206	389 G	34168	232 E
26802	394 H	31061	214 E	31513	216 E	32285	233 E	33207	389 G	34200	226 E
26803	394 H	31062	214 E	31514	216 E	32293	233 E	33207	389 G	34201	226 E
26804	394 H	31071	214 E	31515	216 E	32295	233 E	33208	389 G	34202	226 E
26805	394 H	31072	214 E	31520	217 E	32296	233 E	33208	389 G	34203	226 E
26806	394 H	31081	214 E	31521	217 E	32297	233 E	33208	389 G	34203	226 E
26807	394 H	31082	213 E	31522	217 E	32298	233 E	33209	389 G	34221	228 E
26815	394 H	31091	212 E	31523	217 E	32301	233 E	33209	389 G	34222	231 E
26816	394 H	31101	212 E	31524	217 E	32302	233 E	33210	389 G	34223	228 E
26817	394 H	31111	212 E	31525	217 E	32312	222 E	33210	389 G	34224	229 E
26819	394 H	31121	212 E	31526	217 E	32313	233 E	33211	389 G	34225	229 E
26820	395 H	31131	212 E	31541	217 E	32314	223 E	33211	389 G	34226	229 E
26824	395 H	31132	212 E	31551	217 E	32315	224 E	33212	389 G	34227	228 E
26825	395 H	31140	212 E	31552	218 E	32316	224 E	33212	389 G	34228	228 E
26826	395 H	31141	212 E	31553	218 E	32317	222 E	33215	389 G	34228	228 E
26829	396 H	31142	212 E	31555	217 E	32317	222 E	33215	389 G	34231	231 E
26840	395 H	31143	212 E	31556	217 E	32318	223 E	33220	390 G	34232	231 E
26844	394 H	31144	212 E	31557	217 E	32319	223 E	33220	390 G	34233	230 E
26845	394 H	31145	212 E	31558	217 E	32320	223 E	33221	390 G	34235	231 E
26853	396 H	31146	212 E	31559	217 E	32321	223 E	33221	390 G	34236	230 E
26857	396 H	31148	212 E	31601	221 E	32322	223 E	33246	391 G	34237	231 E
26858	396 H	31150	213 E	31602	221 E	32323	223 E	33247	391 G	34238	230 E
26859	396 H	31151	213 E	31603	221 E	32324	223 E	33248	391 G	34241	228 E
26862	396 H	31155	213 E	31604	221 E	32325	224 E	33249	391 G	34243	228 E
26871	397 H	31218	216 E	31641	221 E	32326	224 E	33250	390 G	34251	229 E
26880	397 H	31220	214 E	31651	221 E	32327	222 E	33250	390 G	34253	229 E
26881	397 H	31221	214 E	31655	221 E	32328	224 E	33252	390 G	34261	229 E
26886	397 H	31222	214 E	32001	219 E	32328	388 G	33252	390 G	34262	228 E
26888	397 H	31231	214 E	32002	219 E	32329	223 E	33254	390 G	34264	230 E
26891	401 H	31232	214 E	32003	219 E	32330	223 E	33254	390 G	34265	230 E
26895	399 H	31233	214 E	32013	219 E	32331	223 E	33255	390 G	34266	231 E
26896	399 H	31234	214 E	32014	219 E	32335	224 E	33255	390 G	34267	231 E
26897	399 H	31235	214 E	32015	219 E	32337	222 E	33256	390 G	34271	226 E
26911	400 H	31270	215 E	32016	219 E	32418	223 E	33256	390 G	34272	226 E
26912	400 H	31271	215 E	32018	219 E	32421	223 E	33257	390 G	34273	226 E
26914	400 H	31280	215 E	32020	219 E	33100	386 G	33257	390 G	34274	226 E
26915	400 H	31281	215 E	32021	219 E	33102	386 G	33258	390 G	34275	226 E
26920	398 H	31320	215 E	32022	221 E	33105	386 G	33258	390 G	34276	226 E
26921	398 H	31322	215 E	32023	221 E	33107	386 G	33270	391 G	34280	226 E
26922	398 H	31330	215 E	32024	219 E	33110	386 G	33275	267 E	34281	226 E
26934	403 H	31332	215 E	32026	219 E	33112	386 G	33275	391 G	34282	226 E
26936	403 H	31334	214 E	32037	221 E	33113	386 G	33280	391 G	34283	226 E
26938	403 H	31340	215 E	32040	221 E	33114	386 G	33285	391 G	34284	226 E
26940	399 H	31341	215 E	32041	221 E	33120	386 G	33286	391 G	34285	226 E
26941	399 H	31343	214 E	32042	221 E	33123	386 G	33289	391 G	34290	228 E
26943	399 H	31343	214 E	32043	221 E	33124	386 G	33289	391 G	34291	228 E
26953	400 H	31360	214 E	32044	221 E	33127	387 G	33291	391 G	34291	228 E
26954	400 H	31362	214 E	32050	221 E	33127	387 G	33292	391 G	34292	228 E
26961	400 H	31380	214 E	32051	221 E	33131	387 G	33293	391 G	34295	229 E
26963	400 H	31382	214 E	32052	221 E	33132	387 G	33298	391 G	34296	229 E
26972	401 H	31390	214 E	32053	221 E	33135	387 G	33299	391 G	34298	230 E
26973	401 H	31392	214 E	32060	219 E	33137	387 G	34005	225 E	34299	230 E
26974	401 H	31400	214 E	32062	219 E	33140	387 G	34006	225 E	34300	260 E
26975	401 H	31402	214 E	32066	219 E	33141	387 G	34007	225 E	34301	226 E
26976	401 H	31403	214 E	32067	219 E	33142	387 G	34027	224 E	34303	260 E
26977	401 H	31404	214 E	32076	219 E	33143	387 G	34033	232 E	34304	226 E
26979	403 H	31452	218 E	32161	220 E	33150	387 G	34041	225 E	34305	218 E
26985	402 H	31453	218 E	32162	220 E	33151	387 G	34051	225 E	34306	218 E
26986	402 H	31454	218 E	32163	220 E	33152	387 G	34053	225 E	34307	218 E
26988	403 H	31455	216 E	32164	220 E	33154	387 G	34061	226 E	34308	218 E
26996	402 H	31456	216 E	32165	220 E	33155	390 G	34071	226 E	34315	188 D
26997	403 H	31461	216 E	32166	220 E	33160	388 G	34081	226 E	34316	146 D
26998	403 H	31467	216 E	32167	220 E	33162	388 G	34091	226 E	34316	188 D
30003	224 E	31468	216 E	32168	220 E	33163	388 G	34101	226 E	34400	228 E
30003	232 E	31471	216 E	32169	220 E	33164	388 G	34111	226 E	34401	228 E
30004	224 E	31481	216 E	32170	216 E	33165	388 G	34115	226 E	34402	231 E
30004	232 E	31491	216 E	32171	220 E	33166	388 G	34116	226 E	34403	231 E
30005	224 E	31493	218 E	32172	220 E	33167	388 G	34117	226 E	34404	229 E
30005	232 E	31494	218 E	32173	216 E	33168	223 E	34118	226 E	34405	228 E
30007	224 E	31495	218 E	32174	220 E	33168	223 E	34119	226 E	34406	230 E
30007	232 E	31496	218 E	32176	220 E	33169	388 G	34121	226 E	34407	231 E
31005	213 E	31497	218 E	32177	220 E	33170	388 G	34122	226 E	34409	229 E
31006	213 E	31498	216 E	32186	220 E	33173	388 G	34132	226 E	34410	229 E
31007	213 E	31499	216 E	32196	220 E	33200	389 G	34142	226 E	34411	231 E
		31500	216 E	32206	220 E	33200	389 G	34152	226 E	34412	230 E
				32216	220 E	33201	389 G	34153	226 E	34413	230 E

číslo položky	str.	číslo položky	str.	číslo položky	str.	číslo položky	str.	číslo položky	str.	číslo položky	str.
34414	232 E	35085	235 E	35552	241 E	37096	255 E	37236	261 E	37539	244 E
34415	228 E	35086	235 E	35553	241 E	37097	255 E	37237	261 E	37541	244 E
34416	228 E	35087	235 E	35555	241 E	37098	255 E	37238	261 E	37545	246 E
34417	231 E	35091	235 E	35603	244 E	37101	221 E	37239	261 E	37546	246 E
34418	231 E	35092	235 E	35604	244 E	37111	221 E	37243	283 E	37549	246 E
34419	229 E	35093	235 E	35605	244 E	37114	261 E	37244	283 E	37560	246 E
34420	228 E	35094	235 E	35833	239 E	37115	261 E	37245	283 E	37564	245 E
34421	230 E	35095	235 E	35845	239 E	37117	250 E	37246	283 E	37570	200 D
34422	231 E	35096	235 E	35850	239 E	37119	261 E	37247	283 E	37570	246 E
34423	231 E	35103	238 E	36014	249 E	37120	261 E	37248	283 E	37600	289 E
34424	230 E	35113	238 E	36024	249 E	37121	267 E	37250	283 E	37601	289 E
34425	229 E	35123	238 E	36034	249 E	37122	267 E	37251	283 E	37602	289 E
34426	229 E	35125	238 E	36035	249 E	37123	381 G	37252	283 E	37603	289 E
34428	230 E	35126	238 E	36036	249 E	37124	381 G	37253	283 E	37604	289 E
34429	232 E	35127	238 E	36046	249 E	37125	254 E	37255	271 E	37605	289 E
34440	228 E	35300	234 E	36056	250 E	37126	254 E	37256	271 E	37606	289 E
34441	228 E	35310	234 E	36057	250 E	37127	254 E	37257	271 E	37611	289 E
34442	229 E	35311	234 E	36058	250 E	37129	381 G	37258	271 E	37615	289 E
34443	229 E	35316	234 E	36059	250 E	37130	253 E	37259	271 E	37616	289 E
34445	228 E	35317	234 E	36076	248 E	37131	253 E	37263	271 E	37621	379 G
34446	228 E	35318	234 E	36077	248 E	37132	253 E	37264	271 E	37630	379 G
34447	229 E	35319	234 E	36080	248 E	37135	128 C	37266	271 E	37640	378 G
34448	231 E	35320	276 E	36081	248 E	37135	403 H	37267	271 E	37641	378 G
34449	228 E	35320	372 G	36082	248 E	37139	128 C	37268	271 E	37645	378 G
34450	228 E	35322	276 E	36085	248 E	37140	128 C	37270	271 E	37650	379 G
34451	228 E	35322	372 G	36086	248 E	37141	128 C	37271	271 E	37730	238 E
34452	231 E	35323	156 D	36087	248 E	37142	128 C	37272	271 E	37730	372 G
34453	229 E	35323	258 E	36126	249 E	37143	128 C	37273	271 E	37731	238 E
34454	228 E	35325	156 D	36128	249 E	37144	128 C	37275	271 E	37731	372 G
34455	230 E	35325	258 E	36130	249 E	37145	128 C	37280	272 E	37760	238 E
34456	231 E	35326	156 D	36136	249 E	37148	253 E	37281	272 E	37760	372 G
34457	231 E	35326	258 E	36145	247 E	37149	253 E	37290	283 E	37761	238 E
34458	230 E	35327	156 D	36160	247 E	37150	253 E	37291	283 E	37761	372 G
34459	232 E	35327	258 E	36175	247 E	37151	253 E	37295	272 E	38000	274 E
34460	228 E	35328	156 D	36190	247 E	37152	253 E	37295	370 G	38001	273 E
34461	228 E	35328	258 E	36191	247 E	37153	253 E	37296	272 E	38002	274 E
34462	231 E	35329	156 D	36199	248 E	37154	253 E	37296	370 G	38003	274 E
34463	231 E	35329	258 E	36200	248 E	37155	253 E	37297	272 E	38004	274 E
34464	229 E	35330	155 D	36240	248 E	37156	253 E	37297	370 G	38005	274 E
34465	228 E	35330	257 E	36300	246 E	37157	253 E	37300	132 C	38006	273 E
34466	230 E	35331	155 D	36305	373 G	37158	253 E	37301	132 C	38007	274 E
34467	231 E	35331	257 E	36306	373 G	37166	245 E	37302	132 C	38008	274 E
34468	231 E	35335	156 D	36308	260 E	37170	254 E	37303	132 C	38009	274 E
34469	230 E	35335	258 E	36310	245 E	37171	254 E	37308	133 C	38010	273 E
34470	229 E	35345	155 D	36312	260 E	37172	254 E	37309	133 C	38012	273 E
34471	229 E	35345	257 E	36313	373 G	37173	254 E	37310	131 C	38013	273 E
34472	228 E	35346	155 D	36314	373 G	37174	254 E	37311	130 C	38014	274 E
34473	228 E	35346	257 E	36318	373 G	37175	254 E	37312	131 C	38014	274 E
34474	228 E	35347	155 D	36319	373 G	37176	254 E	37313	131 C	38015	275 E
34475	228 E	35347	155 D	37005	279 E	37177	254 E	37314	131 C	38016	275 E
34476	228 E	35347	257 E	37006	251 E	37178	254 E	37317	299 F	38017	275 E
34477	229 E	35347	257 E	37006	251 E	37185	254 E	37320	131 C	38018	275 E
34478	231 E	35350	328 F	37007	251 E	37186	254 E	37321	131 C	38020	273 E
34479	232 E	35360	118 C	37007	251 E	37187	254 E	37325	129 C	38021	275 E
34480	228 E	35361	118 C	37008	251 E	37188	254 E	37326	129 C	38022	275 E
34481	228 E	35362	118 C	37009	251 E	37189	254 E	37328	129 C	38024	273 E
34482	228 E	35500	240 E	37010	391 G	37190	254 E	37330	130 C	38025	273 E
34485	229 E	35501	240 E	37011	251 E	37195	253 E	37331	129 C	38026	252 E
34486	229 E	35502	240 E	37012	251 E	37196	253 E	37332	130 C	38026	276 E
34490	230 E	35503	240 E	37021	251 E	37197	253 E	37340	133 C	38030	276 E
34491	230 E	35504	240 E	37025	250 E	37198	253 E	37341	132 C	38031	275 E
34496	231 E	35505	240 E	37025	250 E	37200	252 E	37342	132 C	38042	252 E
34500	232 E	35506	240 E	37026	250 E	37201	252 E	37343	133 C	38042	276 E
35006	236 E	35507	240 E	37026	250 E	37202	252 E	37344	133 C	38050	268 E
35007	236 E	35508	240 E	37028	250 E	37203	252 E	37345	133 C	38052	268 E
35011	237 E	35510	240 E	37028	250 E	37204	252 E	37350	131 C	38054	268 E
35012	236 E	35511	240 E	37029	250 E	37205	252 E	37500	242 E	38055	268 E
35013	236 E	35512	240 E	37029	250 E	37205	253 E	37501	242 E	38060	268 E
35015	237 E	35514	241 E	37031	221 E	37210	252 E	37505	242 E	38063	268 E
35021	237 E	35515	241 E	37041	221 E	37211	252 E	37506	242 E	38065	268 E
35023	235 E	35516	241 E	37051	221 E	37212	252 E	37509	243 E	38089	268 E
35038	235 E	35517	241 E	37053	251 E	37216	261 E	37510	243 E	38095	267 E
35048	237 E	35518	241 E	37054	251 E	37217	261 E	37511	243 E	38096	267 E
35058	235 E	35519	241 E	37055	251 E	37218	261 E	37512	243 E	38097	267 E
35059	235 E	35524	241 E	37065	255 E	37220	252 E	37515	243 E	38895	256 E
35068	237 E	35525	241 E	37066	255 E	37229	262 E	37516	243 E	38896	256 E
35069	236 E	35527	241 E	37067	255 E	37230	262 E	37517	243 E	38899	256 E
35070	236 E	35532	241 E	37068	255 E	37231	262 E	37518	243 E	38900	256 E
35078	236 E	35533	241 E	37069	255 E	37232	262 E	37527	244 E	38901	256 E
35079	236 E	35539	241 E	37070	255 E	37233	262 E	37530	244 E	38902	256 E
35081	236 E	35540	241 E	37094	255 E	37234	262 E	37532	244 E	38903	256 E
35082	236 E	35542	241 E	37095	255 E	37235	262 E	37533	244 E	38904	256 E

REJSTRÍK POLOŽEK



číslo položky	str.	číslo položky	str.	číslo položky	str.	číslo položky	str.	číslo položky	str.	číslo položky	str.
38905	256 E	39145	267 E	42163	350 F	44950	150 D	45045	306 F	45131	317 F
38906	256 E	39165	267 E	42170	350 F	44950	302 F	45046	151 D	45132	317 F
38907	256 E	39190	267 E	42171	350 F	44955	304 F	45046	306 F	45133	318 F
38908	256 E	39192	267 E	42172	350 F	44960	309 F	45047	309 F	45134	315 F
38909	256 E	39192	309 F	42173	350 F	44965	330 F	45048	151 D	45135	317 F
38910	256 E	39193	267 E	42174	350 F	44970	298 F	45048	297 F	45136	318 F
38911	256 E	39193	309 F	42175	350 F	44971	298 F	45048	306 F	45137	318 F
38912	256 E	39194	268 E	42176	350 F	44972	294 F	45049	307 F	45138	316 F
38913	256 E	39195	268 E	42177	350 F	44980	294 F	45050	330 F	45139	316 F
38914	256 E	39196	268 E	42178	350 F	44980	294 F	45051	331 F	45140	315 F
38915	256 E	39197	268 E	42179	350 F	44980	296 F	45052	331 F	45141	316 F
38916	256 E	39198	268 E	42180	350 F	44981	294 F	45053	332 F	45142	315 F
38917	256 E	39199	268 E	42181	350 F	44981	294 F	45054	332 F	45143	316 F
38918	256 E	39200	268 E	42182	350 F	44981	295 F	45055	331 F	45144	317 F
38919	252 E	39201	268 E	42185	350 F	44981	296 F	45056	303 F	45145	317 F
38920	252 E	39202	268 E	42186	350 F	44982	295 F	45057	303 F	45146	319 F
38923	252 E	39203	268 E	42187	350 F	44982	295 F	45058	303 F	45147	320 F
38924	270 E	39204	268 E	42188	350 F	44982	296 F	45059	303 F	45150	320 F
38925	270 E	39205	268 E	42190	269 E	44983	295 F	45060	201 D	45151	321 F
38926	272 E	39206	259 E	42190	350 F	44983	295 F	45060	301 F	45152	319 F
38927	270 E	39207	259 E	42201	351 F	44983	295 F	45061	201 D	45153	319 F
38928	271 E	39210	259 E	42202	351 F	44983	296 F	45061	301 F	45154	319 F
38929	270 E	39212	259 E	42203	351 F	44984	296 F	45062	201 D	45155	320 F
38930	272 E	39214	259 E	42207	351 F	44984	297 F	45062	301 F	45156	320 F
38931	270 E	39216	259 E	42208	351 F	44984	297 F	45063	294 F	45158	320 F
38932	270 E	39217	259 E	42209	351 F	44985	296 F	45064	295 F	45159	321 F
38933	272 E	39218	259 E	42210	351 F	44985	297 F	45065	303 F	45160	320 F
38934	271 E	39219	259 E	42211	351 F	44986	296 F	45066	303 F	45161	321 F
38935	272 E	39234	259 E	42212	351 F	44987	296 F	45067	303 F	45162	319 F
38937	272 E	39238	259 E	42213	351 F	44988	296 F	45068	151 D	45163	320 F
38939	272 E	39245	259 E	42214	351 F	44989	296 F	45068	297 F	45164	321 F
38940	272 E	40050	349 F	42217	351 F	44991	296 F	45068	306 F	45167	320 F
38941	272 E	40051	349 F	42218	351 F	44992	296 F	45069	150 D	45168	321 F
38942	271 E	40052	349 F	42219	351 F	44995	300 F	45069	302 F	45169	321 F
38943	272 E	40053	349 F	42220	351 F	44996	296 F	45070	332 F	45170	323 F
38944	269 E	40054	349 F	42221	351 F	44997	297 F	45071	331 F	45171	323 F
38945	269 E	40055	349 F	42228	351 F	44998	297 F	45074	308 F	45172	323 F
38946	269 E	40056	349 F	42229	351 F	44999	299 F	45079	304 F	45172	323 F
38947	269 E	40057	349 F	42230	351 F	45000	299 F	45080	304 F	45173	323 F
38948	269 E	40058	349 F	42240	351 F	45001	299 F	45081	150 D	45173	323 F
38949	269 E	40059	349 F	42244	351 F	45002	300 F	45081	302 F	45174	323 F
38950	260 E	40060	349 F	42248	351 F	45003	300 F	45082	150 D	45175	322 F
38951	260 E	40075	349 F	42249	351 F	45005	300 F	45082	302 F	45176	322 F
38952	260 E	40076	349 F	42251	351 F	45006	300 F	45083	150 D	45177	322 F
38953	260 E	40100	349 F	42252	351 F	45007	300 F	45083	302 F	45178	322 F
38954	260 E	40120	349 F	42253	351 F	45008	300 F	45084	150 D	45179	321 F
38955	269 E	41050	349 F	42255	351 F	45009	300 F	45084	302 F	45180	315 F
38956	269 E	41080	349 F	42256	351 F	45010	297 F	45085	309 F	45181	315 F
38957	269 E	41081	349 F	42257	351 F	45011	299 F	45086	308 F	45182	322 F
38958	269 E	41082	349 F	42260	351 F	45012	299 F	45088	295 F	45183	322 F
38959	269 E	41083	349 F	42261	351 F	45014	297 F	45089	295 F	45184	321 F
38960	269 E	41100	349 F	42312	259 E	45015	299 F	45093	309 F	45185	321 F
38961	269 E	41101	349 F	42312	350 F	45016	298 F	45094	296 F	45186	321 F
38963	272 E	41102	349 F	42365	268 E	45017	296 F	45095	295 F	45187	322 F
38964	270 E	41103	349 F	42366	268 E	45018	297 F	45096	295 F	45190	324 F
38965	271 E	41120	349 F	42367	268 E	45019	298 F	45097	295 F	45191	324 F
38966	270 E	41121	349 F	42368	268 E	45020	294 F	45098	295 F	45192	324 F
38968	270 E	41122	349 F	42420	259 E	45021	298 F	45099	295 F	45193	324 F
38969	272 E	41123	349 F	43050	355 F	45023	294 F	45100	326 F	45194	324 F
38970	260 E	41150	349 F	43058	356 F	45025	298 F	45101	326 F	45195	324 F
38971	260 E	41151	349 F	43060	356 F	45026	297 F	45102	326 F	45196	324 F
38972	272 E	41152	349 F	43068	356 F	45027	298 F	45104	326 F	45197	324 F
38973	272 E	41153	349 F	43071	355 F	45029	298 F	45105	326 F	45198	324 F
38980	270 E	42101	349 F	43072	355 F	45030	201 D	45106	326 F	45199	324 F
38981	270 E	42102	349 F	43077	355 F	45030	301 F	45107	326 F	45200	324 F
38985	272 E	42103	349 F	43082	356 F	45031	201 D	45108	326 F	45203	325 F
38990	270 E	42110	259 E	43083	356 F	45031	301 F	45110	314 F	45204	325 F
38991	270 E	42112	259 E	43084	356 F	45032	201 D	45111	314 F	45206	324 F
38995	271 E	42113	259 E	43086	356 F	45032	301 F	45112	315 F	45211	325 F
39000	267 E	42115	262 E	43087	357 F	45033	201 D	45113	314 F	45213	317 F
39001	267 E	42120	262 E	43089	357 F	45033	301 F	45114	314 F	45214	319 F
39002	267 E	42150	350 F	43090	357 F	45034	304 F	45115	314 F	45215	318 F
39003	267 E	42151	350 F	43097	356 F	45035	303 F	45116	314 F	45216	319 F
39005	267 E	42152	350 F	43098	357 F	45036	307 F	45117	313 F	45217	319 F
39010	267 E	42153	350 F	43099	357 F	45038	304 F	45118	313 F	45218	318 F
39012	267 E	42155	350 F	43300	347 F	45039	304 F	45120	314 F	45219	318 F
39014	267 E	42156	350 F	43301	347 F	45040	304 F	45122	314 F	45220	325 F
39020	267 E	42157	350 F	44041	307 F	45041	304 F	45123	313 F	45221	325 F
39021	267 E	42158	350 F	44042	307 F	45042	309 F	45124	313 F	45222	325 F
39045	267 E	42160	350 F	44043	307 F	45043	306 F	45125	313 F	45223	325 F
39065	267 E	42161	350 F	44050	307 F	45044	307 F	45126	313 F	45224	325 F
39090	267 E	42162	350 F	44053	309 F	45045	151 D	45130	317 F	45225	325 F

číslo položky	str.	číslo položky	str.	číslo položky	str.	číslo položky	str.	číslo položky	str.	číslo položky	str.
45226	325 F	45392	311 F	45558	308 F	48022	120 C	50033	352 F	50907	369 G
45227	325 F	45393	311 F	45559	308 F	48030	120 C	50035	352 F	50909	369 G
45228	325 F	45394	311 F	45560	307 F	48031	121 C	50036	402 H	50910	369 G
45229	325 F	45395	311 F	45562	308 F	48032	121 C	50037	352 F	50911	369 G
45239	328 F	45396	311 F	45563	308 F	48033	121 C	50036	402 H	50915	369 G
45240	328 F	45397	311 F	45564	308 F	48034	121 C	50037	352 F	50916	369 G
45241	328 F	45398	312 F	45565	308 F	48036	119 C	50038	352 F	50917	369 G
45242	328 F	45399	312 F	45570	350 F	48037	120 C	50040	351 F	50918	369 G
45244	327 F	45400	312 F	45571	350 F	48040	121 C	50041	351 F	50919	369 G
45245	327 F	45401	312 F	45572	350 F	48041	121 C	50042	351 F	50920	369 G
45246	327 F	45410	354 F	45573	350 F	48042	121 C	50050	268 E	51001	368 G
45247	327 F	45415	354 F	45580	350 F	48043	121 C	50050	268 E	51002	368 G
45248	327 F	45420	354 F	45600	325 F	48046	120 C	50051	268 E	51003	368 G
45249	327 F	45425	354 F	45601	325 F	48046	121 C	50052	268 E	51004	368 G
45250	327 F	45426	354 F	45602	325 F	48047	120 C	50052	268 E	51007	368 G
45251	327 F	45427	354 F	45603	325 F	48047	121 C	50100	286 E	51008	367 G
45253	327 F	45450	354 F	45604	325 F	48050	122 C	50101	286 E	51009	368 G
45254	327 F	45451	354 F	45605	325 F	48051	122 C	50102	286 E	51010	368 G
45256	327 F	45452	354 F	45606	325 F	48054	122 C	50103	286 E	51011	368 G
45257	327 F	45453	354 F	45607	325 F	48055	122 C	50104	286 E	51013	367 G
45260	327 F	45460	354 F	45608	325 F	48056	122 C	50106	286 E	51015	368 G
45261	327 F	45461	354 F	45609	325 F	48057	122 C	50108	286 E	51017	367 G
45262	327 F	45462	354 F	45610	325 F	48060	122 C	50500	125 C	51018	367 G
45262	328 F	45463	354 F	45611	325 F	48061	122 C	50501	125 C	51020	367 G
45263	327 F	45465	354 F	45612	325 F	48062	122 C	50502	125 C	51022	367 G
45263	328 F	45466	354 F	45613	325 F	48063	122 C	50503	125 C	51023	367 G
45265	328 F	45467	354 F	45614	325 F	48064	122 C	50505	125 C	51026	366 G
45266	328 F	45470	354 F	45615	325 F	48065	122 C	50510	123 C	51030	367 G
45267	327 F	45471	272 E	45616	325 F	48066	122 C	50511	123 C	51034	367 G
45267	328 F	45471	306 F	45617	325 F	48067	122 C	50512	123 C	51036	368 G
45268	327 F	45471	370 G	45618	325 F	48068	122 C	50513	123 C	51037	368 G
45268	328 F	45472	306 F	45619	325 F	48070	122 C	50514	123 C	51038	368 G
45269	328 F	45473	306 F	45620	325 F	48071	122 C	50518	125 C	51040	366 G
45270	327 F	45480	354 F	45621	325 F	48072	122 C	50519	125 C	51041	366 G
45271	327 F	45485	354 F	45622	325 F	48075	122 C	50520	125 C	51042	366 G
45272	327 F	45490	342 F	45623	325 F	48076	122 C	50521	125 C	51043	366 G
45273	327 F	45496	354 F	45624	325 F	48077	122 C	50522	126 C	51045	367 G
45274	327 F	45497	354 F	45625	325 F	48080	122 C	50523	125 C	51046	367 G
45280	326 F	45498	354 F	45626	325 F	48081	122 C	50524	125 C	51050	369 G
45283	326 F	45499	354 F	45627	325 F	48085	122 C	50525	126 C	51051	369 G
45285	326 F	45500	305 F	45628	325 F	48086	122 C	50526	126 C	51055	369 G
45286	326 F	45502	305 F	45629	325 F	48087	122 C	50527	127 C	51056	369 G
45287	326 F	45503	305 F	45630	325 F	48090	122 C	50529	126 C	51057	369 G
45289	317 F	45505	305 F	45631	325 F	48091	122 C	50530	127 C	51060	366 G
45290	317 F	45506	305 F	45632	325 F	48093	122 C	50531	126 C	51065	366 G
45291	317 F	45508	305 F	45633	325 F	48094	122 C	50532	127 C	51070	366 G
45292	318 F	45509	305 F	45634	325 F	48095	122 C	50533	126 C	51071	366 G
45293	318 F	45511	305 F	45635	325 F	48096	122 C	50537	126 C	51072	366 G
45294	316 F	45512	305 F	45636	325 F	48097	122 C	50539	126 C	51100	288 E
45295	316 F	45513	305 F	45637	325 F	48410	290 E	50540	127 C	51101	288 E
45296	315 F	45515	305 F	45638	325 F	48411	290 E	50541	127 C	51102	288 E
45297	316 F	45516	305 F	45639	325 F	48415	290 E	50542	127 C	51103	288 E
45298	315 F	45517	305 F	45650	307 F	48420	290 E	50544	127 C	51104	288 E
45299	316 F	45518	305 F	45651	307 F	48452	290 E	50549	126 C	51105	288 E
45300	323 F	45519	305 F	45652	307 F	48453	290 E	50550	124 C	51106	288 E
45301	323 F	45520	305 F	45653	307 F	48454	290 E	50551	124 C	51107	288 E
45320	331 F	45521	305 F	45654	307 F	48455	290 E	50553	124 C	51108	288 E
45321	332 F	45522	305 F	45655	307 F	48456	290 E	50554	124 C	51109	288 E
45323	330 F	45523	305 F	45656	307 F	48457	290 E	50555	127 C	51110	288 E
45323	344 F	45524	305 F	45657	307 F	48719	246 E	50556	124 C	51111	288 E
45325	330 F	45525	305 F	45658	307 F	48729	245 E	50557	126 C	51120	288 E
45326	330 F	45526	305 F	45659	307 F	48730	245 E	50558	126 C	51121	288 E
45327	329 F	45527	305 F	45660	307 F	48731	245 E	50559	124 C	51122	288 E
45328	329 F	45528	305 F	45661	307 F	50004	374 G	50560	124 C	51123	288 E
45329	329 F	45529	305 F	45662	307 F	50005	374 G	50562	124 C	51124	288 E
45330	347 F	45530	305 F	45663	307 F	50009	375 G	50563	124 C	51125	288 E
45331	347 F	45531	305 F	45664	307 F	50010	375 G	50564	124 C	51126	288 E
45345	323 F	45532	305 F	45670	307 F	50011	375 G	50570	124 C	51127	288 E
45349	323 F	45533	305 F	45671	307 F	50012	375 G	50571	124 C	51130	288 E
45350	323 F	45534	305 F	45672	307 F	50013	375 G	50585	127 C	51131	288 E
45353	323 F	45535	308 F	45673	307 F	50014	375 G	50585	283 E	51132	288 E
45360	323 F	45540	308 F	48001	119 C	50015	375 G	50586	127 C	51181	375 G
45364	323 F	45541	308 F	48002	119 C	50017	377 G	50586	283 E	51182	375 G
45366	323 F	45542	308 F	48005	120 C	50019	377 G	50587	127 C	51186	369 G
45370	151 D	45543	308 F	48006	120 C	50020	377 G	50587	283 E	51187	369 G
45370	306 F	45550	308 F	48007	120 C	50021	377 G	50588	127 C	51196	288 E
45385	310 F	45551	308 F	48008	121 C	50022	377 G	50588	283 E	51197	288 E
45386	310 F	45552	308 F	48009	121 C	50025	377 G	50900	369 G	51198	288 E
45388	310 F	45553	308 F	48010	121 C	50026	377 G	50901	369 G	51199	288 E
45389	310 F	45555	308 F	48015	119 C	50030	352 F	50902	369 G	51200	369 G
45390	311 F	45556	308 F	48020	120 C	50031	352 F	50905	369 G	51201	369 G
45391	311 F	45557	308 F	48021	120 C	50032	352 F	50906	369 G	51202	369 G

REJSTRÍK POLOŽEK



číslo položky	str.	číslo položky	str.	číslo položky	str.	číslo položky	str.	číslo položky	str.	číslo položky	str.
51203	369 G	51420	287 E	52215	278 E	55350	117 C	61020	336 F	61164	339 F
51204	286 E	51430	287 E	52216	278 E	55351	117 C	61021	335 F	61165	339 F
51205	286 E	51431	287 E	52217	278 E	55352	117 C	61022	336 F	61166	339 F
51206	286 E	51432	287 E	52218	278 E	55353	117 C	61024	337 F	61169	233 E
51207	286 E	51433	287 E	52220	278 E	55354	117 C	61025	335 F	61171	347 F
51208	286 E	51435	287 E	52283	278 E	55355	117 C	61026	335 F	61172	344 F
51209	286 E	51436	287 E	52284	278 E	55356	117 C	61028	339 F	61172	347 F
51210	286 E	51450	287 E	52285	278 E	55357	117 C	61029	335 F	61173	347 F
51211	286 E	51500	363 G	52286	278 E	55358	117 C	61030	333 F	61174	347 F
51212	286 E	51510	363 G	52288	278 E	55359	117 C	61031	333 F	61175	347 F
51220	287 E	51511	363 G	52305	281 E	55360	117 C	61032	333 F	61176	347 F
51221	287 E	51512	363 G	52306	281 E	55361	117 C	61033	333 F	61177	347 F
51222	287 E	51513	363 G	52315	281 E	55362	117 C	61034	333 F	61183	348 F
51225	287 E	51514	363 G	52328	281 E	55400	353 F	61035	340 F	61184	348 F
51226	287 E	51515	363 G	52331	281 E	55401	353 F	61036	340 F	61189	348 F
51227	287 E	51516	363 G	52334	281 E	55402	353 F	61038	340 F	61190	348 F
51241	286 E	51517	363 G	52391	281 E	55403	353 F	61040	340 F	61192	347 F
51242	286 E	52010	376 G	52421	281 E	55404	353 F	61042	340 F	61193	347 F
51243	286 E	52012	376 G	52424	281 E	55405	353 F	61044	339 F	61194	347 F
51244	286 E	52020	376 G	52428	281 E	55406	353 F	61045	333 F	61195	348 F
51245	286 E	52030	226 E	52456	281 E	55420	353 F	61046	333 F	61200	347 F
51246	286 E	52030	376 G	52471	282 E	55421	353 F	61047	333 F	61201	347 F
51247	286 E	52050	290 E	52600	280 E	55422	353 F	61048	333 F	61201	347 F
51257	288 E	52055	290 E	52601	282 E	55423	353 F	61050	336 F	61202	348 F
51258	288 E	52060	290 E	52602	280 E	55424	353 F	61051	336 F	61203	339 F
51259	288 E	52065	290 E	52605	280 E	55425	353 F	61052	337 F	61204	348 F
51260	288 E	52070	278 E	52610	280 E	55429	353 F	61053	336 F	61205	348 F
51261	288 E	52071	279 E	52620	283 E	55430	353 F	61054	337 F	61206	348 F
51262	288 E	52075	279 E	52625	283 E	55431	353 F	61056	335 F	61207	348 F
51263	288 E	52076	279 E	52630	283 E	55432	353 F	61057	335 F	61208	348 F
51264	288 E	52077	279 E	52635	283 E	55433	353 F	61058	337 F	61209	339 F
51265	288 E	52078	279 E	52640	283 E	55436	353 F	61059	337 F	61215	348 F
51271	286 E	52101	344 F	52645	283 E	55437	353 F	61060	333 F	61218	233 E
51272	286 E	52102	344 F	52652	283 E	55450	352 F	61061	333 F	61219	348 F
51273	286 E	52103	344 F	52656	283 E	55452	353 F	61062	333 F	61221	341 F
51274	286 E	52104	344 F	52662	282 E	55453	353 F	61063	333 F	61221	341 F
51275	286 E	52105	344 F	52666	282 E	55454	353 F	61067	341 F	61221	341 F
51276	286 E	52108	344 F	52671	282 E	55455	353 F	61068	341 F	61221	341 F
51278	286 E	52109	345 F	52694	282 E	55456	353 F	61069	341 F	61222	339 F
51280	287 E	52110	374 G	52695	282 E	55457	353 F	61070	341 F	61223	338 F
51281	287 E	52111	374 G	54008	283 E	55460	353 F	61077	342 F	61224	340 F
51282	287 E	52113	345 F	55040	117 C	55461	353 F	61079	342 F	61224	340 F
51283	287 E	52114	345 F	55041	117 C	55462	353 F	61085	304 F	61230	348 F
51284	287 E	52115	345 F	55050	117 C	55640	291 E	61088	336 F	61235	376 G
51286	287 E	52116	345 F	55051	117 C	55642	291 E	61089	335 F	61236	376 G
51287	287 E	52119	343 F	55060	117 C	55645	291 E	61090	336 F	61240	92 C
51288	287 E	52125	347 F	55080	117 C	60001	346 F	61097	338 F	61250	348 F
51300	286 E	52126	347 F	55100	117 C	60006	346 F	61098	338 F	61251	309 F
51301	286 E	52130	252 E	55101	117 C	60008	346 F	61111	340 F	61251	348 F
51302	286 E	52160	344 F	55120	117 C	60012	346 F	61112	340 F	61252	348 F
51303	286 E	52161	344 F	55121	117 C	60018	347 F	61114	340 F	61253	348 F
51304	286 E	52162	344 F	55140	117 C	60019	347 F	61120	340 F	61254	348 F
51305	286 E	52163	344 F	55141	117 C	60020	347 F	61121	340 F	61255	348 F
51306	286 E	52164	344 F	55160	117 C	60022	347 F	61130	331 F	61256	348 F
51307	286 E	52168	343 F	55180	117 C	60100	233 E	61131	331 F	61290	341 F
51308	286 E	52173	343 F	55181	117 C	60115	245 E	61132	331 F	61291	341 F
51320	286 E	52175	343 F	55200	117 C	60116	245 E	61133	331 F	61292	341 F
51321	286 E	52176	343 F	55201	117 C	60117	245 E	61134	332 F	61293	341 F
51322	286 E	52185	344 F	55220	117 C	60118	245 E	61135	332 F	61294	341 F
51323	286 E	52186	344 F	55221	117 C	60121	245 E	61136	329 F	61295	341 F
51324	286 E	52187	344 F	55240	117 C	60123	245 E	61137	329 F	61296	341 F
51325	286 E	52188	344 F	55300	117 C	60201	346 F	61138	329 F	61297	341 F
51327	286 E	52189	344 F	55301	117 C	60206	346 F	61139	330 F	61299	352 F
51338	288 E	52190	344 F	55311	117 C	60208	346 F	61140	330 F	61300	352 F
51340	288 E	52191	344 F	55313	117 C	60212	346 F	61141	332 F	61301	352 F
51341	288 E	52192	344 F	55314	117 C	61000	336 F	61142	332 F	61302	352 F
51348	288 E	52193	344 F	55315	117 C	61001	336 F	61143	333 F	61320	92 C
51402	287 E	52194	344 F	55316	117 C	61002	337 F	61144	333 F	61321	92 C
51403	287 E	52195	345 F	55317	117 C	61003	338 F	61145	333 F	61322	92 C
51404	287 E	52196	345 F	55318	117 C	61004	337 F	61146	333 F	61323	92 C
51405	287 E	52197	344 F	55319	117 C	61005	334 F	61147	329 F	61324	92 C
51406	287 E	52198	343 F	55331	117 C	61006	334 F	61148	329 F	61325	92 C
51407	287 E	52202	278 E	55332	117 C	61007	335 F	61149	330 F	61326	92 C
51408	287 E	52203	278 E	55333	117 C	61008	334 F	61150	331 F	61327	92 C
51410	287 E	52204	278 E	55334	117 C	61009	339 F	61151	331 F	61328	92 C
51412	287 E	52205	278 E	55335	117 C	61010	335 F	61155	334 F	61329	92 C
51413	287 E	52206	278 E	55336	117 C	61012	339 F	61156	334 F	61330	92 C
51414	287 E	52207	278 E	55337	117 C	61013	338 F	61157	334 F	61331	92 C
51415	287 E	52208	278 E	55339	117 C	61014	339 F	61158	334 F	61340	95 C
51416	287 E	52212	278 E	55340	117 C	61015	335 F	61161	337 F	61341	95 C
51417	287 E	52213	278 E	55341	117 C	61018	338 F	61162	338 F	61342	95 C
51418	287 E	52214	278 E	55342	117 C	61019	338 F	61163	338 F	61343	95 C

číslo položky	str.	číslo položky	str.	číslo položky	str.	číslo položky	str.	číslo položky	str.	číslo položky	str.
61344	95 C	70221	374 G	81231	383 G	81314	383 G	81398	383 G	89973	277 E
61345	95 C	81011	382 G	81232	383 G	81315	383 G	81399	383 G	89973	371 G
61346	95 C	81012	382 G	81233	383 G	81316	383 G	81400	383 G	89975	277 E
65062	291 E	81013	382 G	81234	383 G	81317	383 G	81401	383 G	89975	371 G
65063	291 E	81014	382 G	81235	383 G	81318	383 G	81402	383 G	89980	277 E
65064	291 E	81015	382 G	81236	383 G	81319	383 G	81403	383 G	89980	371 G
65065	291 E	81016	382 G	81237	383 G	81320	383 G	81404	383 G	89985	277 E
69900	264 E	81022	382 G	81238	383 G	81321	383 G	81405	383 G	89985	371 G
69901	264 E	81023	382 G	81239	383 G	81322	383 G	81406	383 G	89987	277 E
69902	264 E	81024	382 G	81240	383 G	81323	383 G	81407	383 G	89987	371 G
69903	264 E	81025	382 G	81241	383 G	81324	383 G	81408	383 G	89988	277 E
69904	263 E	81035	382 G	81242	383 G	81325	383 G	81409	383 G	89988	371 G
69905	264 E	81036	382 G	81243	383 G	81326	383 G	81410	383 G	89989	277 E
69906	264 E	81053	380 G	81244	383 G	81327	383 G	81411	383 G	89989	371 G
69907	266 E	81054	380 G	81245	383 G	81328	383 G	81412	383 G	89990	277 E
69908	266 E	81055	380 G	81246	383 G	81329	383 G	81413	383 G	89990	371 G
69909	266 E	81056	380 G	81247	383 G	81330	383 G	81414	383 G	90070	250 E
69910	265 E	81057	380 G	81248	383 G	81331	383 G	81415	383 G	90071	250 E
69911	265 E	81070	380 G	81249	383 G	81332	383 G	81416	383 G	90072	250 E
69912	265 E	81071	380 G	81250	383 G	81333	383 G	81417	383 G		
69914	264 E	81072	380 G	81251	383 G	81334	383 G	81418	383 G		
69917	265 E	81073	380 G	81252	383 G	81335	383 G	81419	383 G		
69918	263 E	81074	380 G	81253	383 G	81336	383 G	81420	383 G		
69919	263 E	81075	380 G	81254	383 G	81337	383 G	81421	383 G		
69920	266 E	81076	380 G	81255	383 G	81338	383 G	81422	383 G		
69923	266 E	81077	380 G	81256	383 G	81339	383 G	81423	383 G		
69928	266 E	81100	380 G	81257	383 G	81340	383 G	81424	383 G		
69930	265 E	81101	380 G	81258	383 G	81341	383 G	81425	383 G		
69931	265 E	81102	380 G	81259	383 G	81342	383 G	81426	383 G		
70020	114 C	81103	380 G	81260	383 G	81343	383 G	81427	383 G		
70021	114 C	81104	380 G	81261	383 G	81344	383 G	81428	383 G		
70025	114 C	81105	380 G	81262	383 G	81345	383 G	81429	383 G		
70026	114 C	81106	380 G	81263	383 G	81346	383 G	81430	383 G		
70030	114 C	81113	380 G	81264	383 G	81347	383 G	81431	383 G		
70031	114 C	81114	380 G	81265	383 G	81348	383 G	81432	383 G		
70032	114 C	81115	380 G	81266	383 G	81349	383 G	81433	383 G		
70033	114 C	81150	384 G	81267	383 G	81350	383 G	81434	383 G		
70035	114 C	81151	384 G	81268	383 G	81351	383 G	81435	383 G		
70036	114 C	81152	384 G	81269	383 G	81352	383 G	81436	383 G		
70037	114 C	81155	384 G	81270	383 G	81353	383 G	81437	383 G		
70038	114 C	81160	385 G	81271	383 G	81354	383 G	81438	383 G		
70040	114 C	81165	385 G	81272	383 G	81355	383 G	81439	383 G		
70045	114 C	81170	384 G	81273	383 G	81356	383 G	81440	383 G		
70046	114 C	81175	385 G	81274	383 G	81357	383 G	81441	383 G		
70060	115 C	81178	385 G	81275	383 G	81358	383 G	81442	383 G		
70061	115 C	81180	385 G	81276	383 G	81359	383 G	81443	383 G		
70062	115 C	81185	384 G	81277	383 G	81360	383 G	81444	383 G		
70063	115 C	81186	384 G	81278	383 G	81361	383 G	81445	383 G		
70064	115 C	81189	384 G	81279	383 G	81362	383 G	81447	383 G		
70065	116 C	81190	385 G	81280	383 G	81363	383 G	81448	383 G		
70066	115 C	81191	385 G	81281	383 G	81364	383 G	81449	383 G		
70070	116 C	81200	383 G	81282	383 G	81365	383 G	81450	383 G		
70075	116 C	81201	383 G	81284	383 G	81366	383 G	81451	383 G		
70090	116 C	81202	383 G	81285	383 G	81367	383 G	81452	383 G		
70091	116 C	81203	383 G	81286	383 G	81370	383 G	81453	383 G		
70092	116 C	81204	383 G	81287	383 G	81371	383 G	81454	383 G		
70093	116 C	81205	383 G	81288	383 G	81372	383 G	81455	383 G		
70094	116 C	81206	383 G	81289	383 G	81373	383 G	81456	383 G		
70095	116 C	81207	383 G	81290	383 G	81374	383 G	81457	383 G		
70096	116 C	81208	383 G	81291	383 G	81375	383 G	81458	383 G		
70098	70 C	81209	383 G	81292	383 G	81376	383 G	81459	383 G		
70100	365 G	81210	383 G	81293	383 G	81377	383 G	81460	383 G		
70101	365 G	81211	383 G	81294	383 G	81378	383 G	81461	383 G		
70102	365 G	81212	383 G	81295	383 G	81379	383 G	81462	383 G		
70103	365 G	81213	383 G	81296	383 G	81380	383 G	81463	383 G		
70104	365 G	81214	383 G	81297	383 G	81381	383 G	81466	383 G		
70105	365 G	81215	383 G	81298	383 G	81382	383 G	81467	383 G		
70106	365 G	81216	383 G	81299	383 G	81383	383 G	81468	383 G		
70107	365 G	81217	383 G	81300	383 G	81384	383 G	81469	383 G		
70108	365 G	81218	383 G	81301	383 G	81385	383 G	81470	383 G		
70109	365 G	81219	383 G	81302	383 G	81386	383 G	81471	383 G		
70110	365 G	81220	383 G	81303	383 G	81387	383 G	81472	383 G		
70114	364 G	81221	383 G	81304	383 G	81388	383 G	81473	383 G		
70120	364 G	81222	383 G	81305	383 G	81389	383 G	81486	383 G		
70121	364 G	81223	383 G	81306	383 G	81390	383 G	81600	381 G		
70122	364 G	81224	383 G	81307	383 G	81391	383 G	81603	381 G		
70123	364 G	81225	383 G	81308	383 G	81392	383 G	82101	262 E		
70124	364 G	81226	383 G	81309	383 G	81393	383 G	82104	262 E		
70125	364 G	81227	383 G	81310	383 G	81394	383 G	82105	262 E		
70140	364 G	81228	383 G	81311	383 G	81395	383 G	82109	262 E		
70141	364 G	81229	383 G	81312	383 G	81396	383 G	89970	277 E		
70220	374 G	81230	383 G	81313	383 G	81397	383 G	89970	371 G		

GRAFICKÉ SYMBOLY POUŽITÉ V KATALOGU

PIKTOGRAMY SPECIFIKACE PRODUKTŮ



SPECIFIKACE POUŽITÍ

- dřevo ·
- keramika ·
- plasty ·
- hliník ·
- měď ·
- kámen ·
- sklo ·
- zdivo ·
- papír ·
- ocel ·
- kompozit ·
- obklady ·
- nerezová ocel ·
- omítka ·
- dřevo se šrouby, hřebíky ·
- sádrokarton ·
- pro vrtání do materiálů s pevností v tahu do ... ·

- S2** · funkční části z vysoce legované nástrojové oceli S2
- HSS** · funkční části vyrobeny z rychlořezné oceli
- Cr-Mo** · funkční části z chrom-molybdenové oceli
- CrV** · funkční části z chrom-vanadové oceli
- INOX** · funkční části z nerezavějící oceli
- NYLON** · nylonová rukojeť
- TEFLON** · teflonový povrch
- Zn** · zinkováno
- TiN** · povrch potažen nitridem titanu
- HRC 58-61** · tvrdost materiálu funkčních částí podle Rockwella
- 40% PES** · složení materiálu - obsahuje 40% polyesteru
- PES** · složení materiálu - vyrobeno z polyesteru
- diamantová zrna na povrchu funkčních částí
- magnetické

- SDS+** **SDS MAX** **M14** · způsob uchycení
- počet zubů ráčny
- 1/2"** **3/4"** **1/4"** · velikost uchycení
- údaj o výši ochrany sluchu
- DIN 3113** · splňuje uvedenou normu
- 32x** · počet produktů v sadě
- II. class** **III. class** · splňuje uvedenou třídu přesnosti
- vhodné do chladného počasí
- ergonomická rukojeť
- HOBBY** · pro hobby použití
- počet a typ baterií
- odolné proti UV záření
- nárazuvzdorné gumové koncovky

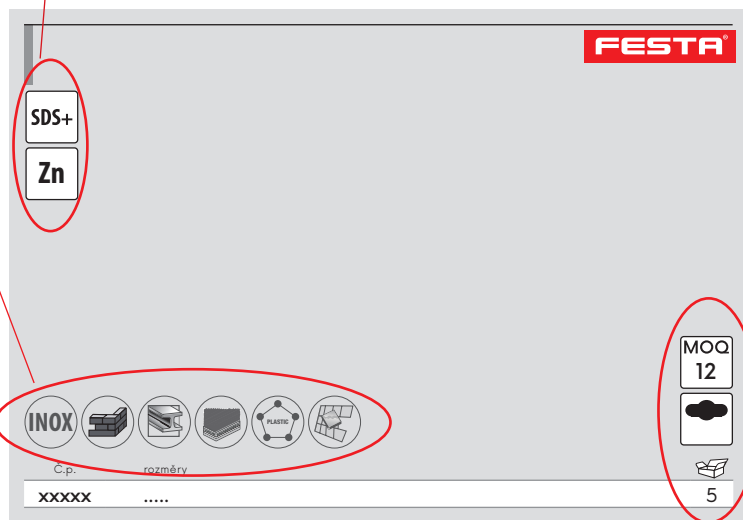

SPECIFIKACE BALENÍ

- baleno v krabici
- balení se závěsem
- MOQ 12** · minimální objednatelné množství
- počet kusů v balení

SPECIFIKACE PRODUKTŮ VODNÍHO PROGRAMU

- volitelný tvar proudu vody ·
- minimální a maximální tlak ·
- maximální průtok vody ·
- zavlažovaná plocha ·
- velikost závitu pro připojení adaptéru ·
- průměr hadice pro připojení do rychlospojky ·

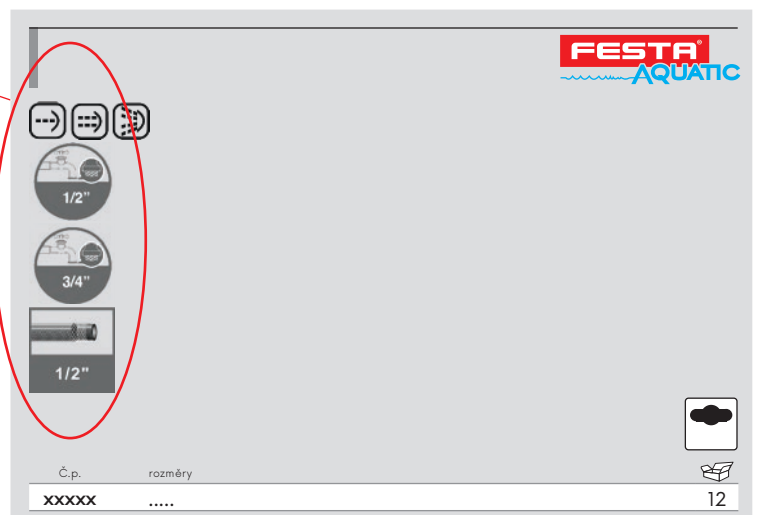



2022



www.festa.tools