

FESTA[®]

PROFESSIONAL  TOOLS

2022





Brand of high quality hand tools for building, workshop and garden



Brand of top quality levels



Brand of high quality levels and mason staff



Professional watering assortment with modern design, compatible with Rosa product line



Quality watering systems and garden tools



Japanese knives with a long tradition



Professional measuring tapes



Professional tile cutter



Manufacturer of quality garden shears



Professional building mixers



Professional screwdriver attachments



Brand of professional saws

MEASURING TOOLS

2 - 37



WORKSHOP TOOLS

38 - 133



CUTTING AND GRINDING TOOLS

134 - 209



BUILDING TOOLS

210 - 291



GARDEN TOOLS

292 - 257



HARDWARE TOOLS

358 - 391



AUTOMOTIVE

391 - 403



LIST OF ITEMS

404 - 416



MEASURING TOOLS

2 - 37



4

MEASURING TAPE KOMELON



6

MEASURING TAPE FESTA



9

LONG MEASURING TAPE



10

FOLDING RULE



12

WORKSHOP CALIPER



13

RULES AND SQUARES



15

SPIRIT AND SCREEDING LEVELS HORIZONT



20

SPIRIT LEVEL NIVELA



21

DIGITAL LEVEL AND SQUARE



23

LASERLINER



32

PENCILS AND MARKERS



36

SPRAYERS

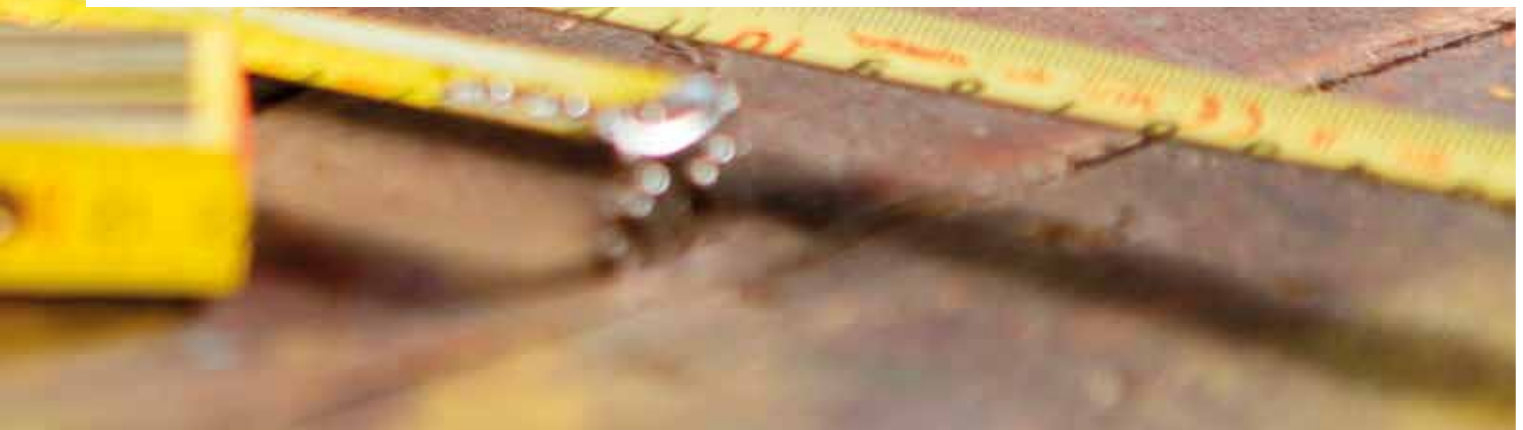



KOMELON®

- II. class accuracy reg. ČSN 251104, EEC 755345
- nylon coating of the blade DURA NY Coat™ guarantees 10x higher resistant of the measuring blade

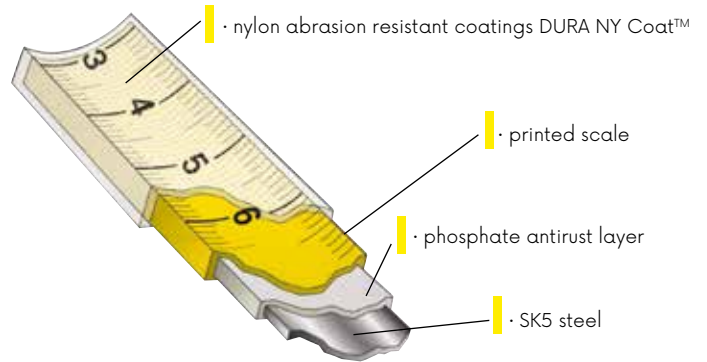

MEASURING TAPE

KOMELON®



· Nylon abrasion resistant coatings DURA NY Coat™



No.	specification	
10002	2 m · 16 mm	10
10003	3 m · 16 mm	10
10005	5 m · 19 mm	10
10008	8 m · 25 mm	10

MEASURING TAPE

KOMELON®



· Nylon abrasion resistant coatings DURA NY Coat™



No.	specification	
10025	5 m · 25 mm	10

MEASURING TAPE

KOMELON®



· Nylon abrasion resistant coatings DURA NY Coat™



- automatic break
- anti-slip rubber coating

No.	specification	
10033	3 m · 16 mm	6
10035	5 m · 19 mm	6

MEASURING TAPE

KOMELON®



No.	specification	
10043	3 m · 16 mm	30
10045	5 m · 19 mm	30
10048	8 m · 25 mm	12

LONG STEEL TAPE

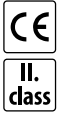
KOMELON®

No.	specification	
10110	10 m · 10 mm	6
10120	20 m · 10 mm	6
10130	30 m · 10 mm	6

FIBERGLASS TAPE

KOMELON®

No.	specification	
10330	10 m · 13 mm	6
10332	20 m · 13 mm	6
10334	30 m · 13 mm	6
10336	50 m · 13 mm	6

FIBERGLASS TAPE

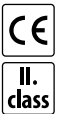
KOMELON®

No.	specification	
10430	30 m · 13 mm	1
10450	50 m · 13 mm	1
10490	100 m · 13 mm	1

PROMOTIONAL STAND

KOMELON®

· items in stand 10996

- 10003 · 5 ks | pcs
- 10005 · 4 ks | pcs
- 10008 · 1 ks | pcs
- 10033 · 2 ks | pcs
- 10035 · 3 ks | pcs
- 10045 · 2 ks | pcs
- 10025 · 3 ks | pcs
- 10110 · 1 ks | pcs
- 10120 · 1 ks | pcs
- 10130 · 1 ks | pcs
- 10430 · 1 ks | pcs
- 10330 · 1 ks | pcs
- 10332 · 1 ks | pcs
- 10334 · 1 ks | pcs
- 10336 · 1 ks | pcs



· illustration photo

PROMOTIONAL STAND



· illustration photo

No.	specification	
10998		1

No.	specification	
10999	promotional stand for measuring tapes	1
10996	stand filled with items	1



· Information about the tape



· length of tape



· the number of the accredited certification office issuing the certificate



· accuracy class



· producer



· declaration of conformity - CE



· special tape adjustment



· year of manufacture



· the temperature at which the test was performed



FESTA

MEASURING TAPE

FESTA

- CE
- II. class
- NYLON



- scale with big numerals
- anti-slip rubber coating
- nylon coat

No.	specification	
11353	3 m · 19 mm	1
11355	5 m · 19 mm	1
11356	5 m · 25 mm	1
11358	8 m · 25 mm	1
11360	10 m · 25 mm	1

MEASURING TAPE

FESTA

- CE
- II. class
- NYLON

- antislip rubber coating PTE

- hanger



- automatic break

- chrome coated metal clip

- ABS housing

- nylon coat

No.	specification	
11343	3 m · 16 mm	6
11345	5 m · 19 mm	6
11347	7,5 m · 25 mm	6

MEASURING TAPE - MAGNET **FESTA**

- CE
- II. class
- NYLON



- 3 x break
- magnetic hook
- lock up
- anti-slip rubber coating

No.	specification	
11323	3 m · 16 mm	10
11325	5 m · 19 mm	8
11327	7,5 m · 25 mm	6

MEASURING TAPE COMPACT **FESTA**

- CE
- II. class
- NYLON



- small size of measuring tape
- nylon coat

No.	specification	
11220	3 m · 16 mm	12
11221	5 m · 19 mm	12

MEASURING TAPE **FESTA**

- CE
- II. class



- scale with big numerals

No.	specification	
11226	2 m · 16 mm	10
11239	3 m · 19 mm	10
11259	5 m · 19 mm	10
11260	7,5 m · 25 mm	10

MEASURING TAPE - MAGNETIC



- magnetic hook
- anti-slip rubber coating
- fluorescent tape
- scale with big numerals



No.	specification	
11102	2 m · 16 mm	10
11103	3 m · 16 mm	10
11105	5 m · 19 mm	10
11106	5 m · 25 mm	10
11107	7,5 m · 25 mm	10
11110	10 m · 25 mm	10

MEASURING TAPE



- automatic break
- anti-slip rubber coating



No.	specification	
11333	3 m · 16 mm	12
11335	5 m · 19 mm	12
11337	7,5 m · 25 mm	12
11338	10 m · 25 mm	12

MEASURING TAPE



- matt adjustment of tape



No.	specification	
11002	2 m · 13 mm	12
11003	3 m · 13 mm	12
11005	5 m · 13 mm	12
11006	5 m · 19 mm	12
11007	7,5 m · 19 mm	12
11008	10 m · 25 mm	12

MEASURING TAPE - ERGO



- lock up
- anti-slip rubber coating



No.	specification	
11082	2 m · 16 mm	12
11083	3 m · 16 mm	12
11085	5 m · 19 mm	12

MEASURING TAPE



- metric and inch scale
- anti-slip rubber coating



No.	specification	
11416	5 m · 19 mm	10

MEASURING TAPE



- lock up



No.	specification	
11200	2 m · 13 mm	24
11201	2 m · 16 mm	24
11202	2 m · 19 mm	24
11204	3 m · 13 mm	24
11205	3 m · 16 mm	24
11206	3 m · 19 mm	24
11207	5 m · 19 mm	12
11208	5 m · 25 mm	12
11209	7,5 m · 25 mm	12
11210	10 m · 25 mm	12

FLAT SELF ADHESIVE METAL MEASURING TAPE

II. class



No.	specification	
11311	1 m · 12,5 mm	30
11312	2 m · 12,5 mm	30
11313	3 m · 16 mm	30
11314	5 m · 19 mm	30

MEASURING TAPE WITH PRINTED NAME, 3M • 16 MM

CE
II. class



10

No.	name	No.	name	No.	name
13500	JIŘÍ	13512	MICHAL	13524	ROMAN
13501	PETR	13513	MILAN	13525	ŠIKULA
13502	JOSEF	13514	KAREL	13526	RADEK
13503	TOMÁŠ	13515	VLADIMÍR	13527	MISTR
13504	JAN	13516	DĚDEČEK	13528	ONDŘEJ
13505	MARTIN	13517	MŮJ METR	13529	MAREK
13506	JAROSLAV	13518	VÁCLAV	13530	STANISLAV
13507	FRANTIŠEK	13519	JAKUB	13531	BOREC
13508	PAVEL	13520	LUKÁŠ	13532	TATÍNEK
13509	MIROSLAV	13521	2X MĚŘ	13533	ANTONÍN
13510	BIG BOSS	13522	LADISLAV	13534	ALEŠ
13511	ZDENĚK	13523	DAVID		

MEASURING TAPE - KEYCHAIN

II. class



MEASURING TAPE - KEYCHAIN



- scale with big numerals
- properties of classical measuring tape

MOQ 12

No.	specification	
11410	2 m · 16 mm 6 colours	12

No.	specification	
11420	1 m · 6 mm orange	24

MEASURING TAPE - KEYCHAIN



MEASURING TAPE - KEYCHAIN



LIBELA - KEYCHAIN



No.	specification	
11444	1 m · 6 mm white	24

No.	specification	
11425	1 m · 6 mm	50

No.	specification	
11445		100

LONG STEEL TAPE TAPE

CE
II. class

FESTA



· loop

No.	specification	
12010	10 m · 10 mm	1
12020	20 m · 10 mm	1
12030	30 m · 10 mm	1
12050	50 m · 10 mm	6

FIBERGLASS TAPE

CE
II. class

FESTA



· loop

No.	specification	
12110	10 m · 13 mm	6
12120	20 m · 13 mm	1
12130	30 m · 13 mm	1
12150	50 m · 13 mm	1

LONG STEEL TAPE

CE
II. class

FESTA



· loop + hook

No.	specification	
12210	10 m · 10 mm	6
12220	20 m · 10 mm	6
12230	30 m · 10 mm	6
12250	50 m · 10 mm	6

LONG STEEL TAPE

FESTA

CE
II. class



· loop

No.	specification	
12433	30 m · 12,5 mm	20
12435	50 m · 12,5 mm	10

TELESCOPIC MEASURING POLE

FESTA



· with bag

No.	specification	
15983	0,7 - 3 m	10
15985	1,1 - 5 m	10
15988	1,6 - 8 m	5

MEASURING WHEEL

2x AAA

- resistant, light and compact
- counter attribute when moving forward and subtract when moving back
- built-in lighting - 2 x AAA bateries in handle



No.	specification	
15989	max. 10 km	2



FOLDING RULE



No.	specification	
13010	1 m · white	20
13020	2 m · white	10
13021	1 m · yellow	20
13022	2 m · yellow	10
13023	2 m · white - yellow	10
13030	3 m · white	10

FOLDING RULE



No.	specification	
13111	1 m · yellow	10
13120	2 m · yellow	5

FOLDING RULE



No.	specification	
13210	1 m · mini	10
13211	1 m	1
13220	2 m	1

RULER WITH HANDLE



· 2 x vials

No.	specification	
14030	600 mm	6

STAINLESS STEEL RULER



No.	specification	
14010	300 mm	10
14011	600 mm	20
14012	1000 mm	20

RULER ALUMINIUM



No.	specification	
14015	400 mm	48
14017	600 mm	50
14019	1000 mm	40

MULTIPURPOSE RULE

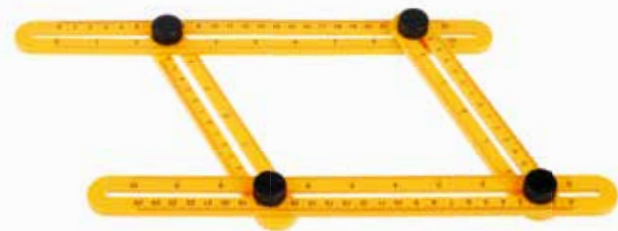

No.	specification	
14480	250 x 120 mm	1



FOLDING RULE WITH NAME



STAND FOR FOLDING RULE



10

No.	name	No.	name	No.	name
13401	JIRÍ	13425	RADEK	13449	VOJTĚCH
13402	JAN	13426	DANIEL	13450	ZDENKO
13403	PETR	13427	ANTONÍN	13451	JANA
13404	JOSEF	13428	VOJTĚCH	13452	EVA
13405	PAVEL	13429	FILIP	13453	PETRA
13406	MARTIN	13430	ADAM	13454	MAJKA
13407	JAROSLAV	13431	MILOSLAV	13455	HANA
13408	TOMÁŠ	13432	MATĚJ	13456	ANNA
13409	MIROSLAV	13433	ALEŠ	13457	LENKA
13410	ZDENĚK	13434	JAROMÍR	13458	KATKA
13411	FRANTIŠEK	13435	LIBOR	13459	LUCIE
13412	VÁCLAV	13436	DOMINIK	13460	ALENA
13413	MICHAL	13437	PATRIK	13461	VERONIKA
13414	MILAN	13438	VLASTIMIL	13462	MARTINA
13415	KAREL	13439	JINDŘICH	13463	JITKA
13416	JAKUB	13440	MILOŠ	13464	BIG BOSS
13417	DAVID	13441	JÁN	13465	2 x MĚŘ
13418	LUKÁŠ	13442	PETER	13466	TATÍNEK
13419	VLADIMÍR	13443	ONDREJ	13467	DĚDEČEK
13420	LADISLAV	13444	JOZEF	13468	ŠIKULA
13421	ONDŘEJ	13445	PAVOL	13469	MISTR
13422	ROMAN	13446	L'UBOMÍR	13470	MACHR
13423	STANISLAV	13447	KAROL	13471	BOREC
13424	MAREK	13448	RADOSLAV	13472	UŽ JE MŮJ
				13473	MŮJ METR

· items in stand 13399



- 13401 · 15 ks | pcs
- 13402 · 15 ks | pcs
- 13403 · 15 ks | pcs
- 13404 · 15 ks | pcs
- 13405 · 15 ks | pcs
- 13406 · 15 ks | pcs
- 13412 · 15 ks | pcs
- 13413 · 15 ks | pcs
- 13414 · 15 ks | pcs
- 13415 · 15 ks | pcs
- 13416 · 15 ks | pcs
- 13417 · 15 ks | pcs
- 13418 · 15 ks | pcs
- 13419 · 15 ks | pcs
- 13420 · 15 ks | pcs
- 13421 · 10 ks | pcs
- 13422 · 10 ks | pcs
- 13423 · 10 ks | pcs
- 13424 · 10 ks | pcs
- 13425 · 10 ks | pcs
- 13426 · 10 ks | pcs
- 13427 · 10 ks | pcs
- 13428 · 10 ks | pcs
- 13429 · 10 ks | pcs
- 13430 · 10 ks | pcs
- 13431 · 10 ks | pcs
- 13432 · 10 ks | pcs
- 13433 · 10 ks | pcs
- 13434 · 10 ks | pcs
- 13435 · 10 ks | pcs
- 13436 · 10 ks | pcs
- 13437 · 10 ks | pcs
- 13438 · 10 ks | pcs
- 13439 · 10 ks | pcs
- 13440 · 10 ks | pcs

No.	specification	
13399	Stand filled with items	1
13400	Only stand without items	1

WORKSHOP CALIPER DIGITAL



INOX



No.	specification	
14007	150 0,01 mm	10
14008	200 0,01 mm	10
14009	300 0,01 mm	10



WORKSHOP CALIPER DIGITAL FIBERGLASS



· accuracy 0.2 mm, resolution 0.1 mm

No.	specification	
14013	150 0,2 mm	10



WORKSHOP CALIPER



INOX

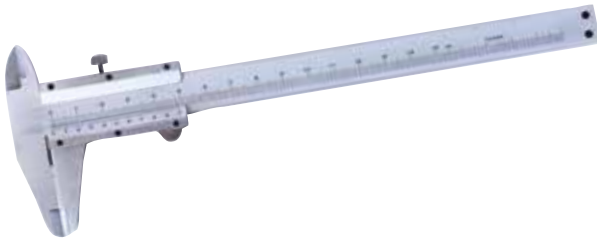

No.	specification	
14001	150 0,02 mm	10
14002	200 0,02 mm	10
14003	300 0,02 mm	10



WORKSHOP CALIPER



INOX

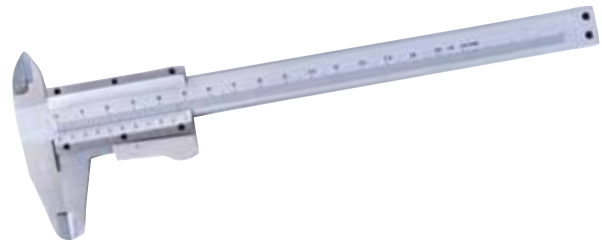

No.	specification	
14004	150 0,02 mm	10



OUTSIDE MIKROMETER



No.	specification	
14040	0 - 25 0,01 mm	10
14045	25 - 50 0,01 mm	10



WORKSHOP CALIPER



HOBBY

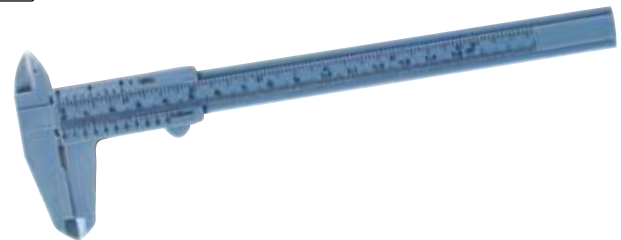

No.	specification	
14006	150 mm	50



DIAL INDICATOR



INOX



No.	specification	
14035	0 - 10mm 0,01 mm	10



FEELER GAGES



· 20 leaves

No.	specification	
14080	0,05 - 1 mm	10



PROTRACTOR



INOX



· with case

No.	specification	
14060	0° - 180° · 150 x 200 mm	5
14070	0° - 180° · 300 x 500 mm	7

PROTRACTOR

HOBBY



No.	specification	
14075	0° - 180° · 230 x 500 mm	30

MULTIFUNCTION SQUARE

ALU



No.	specification	
14420	180 mm	10
14421	NEW 300 mm	10

SQUARE



SQUARE



No.	specification		No.	specification		No.	specification	
14220	200 x 125 mm	10	14235	350 x 190 mm	10	14350	500 x 235 mm	10
14225	250 x 135 mm	10	14240	400 x 190 mm	10	14360	600 x 300 mm	10
14230	300 x 135 mm	10	14250	500 x 210 mm	10	14370	700 x 300 mm	10
						14380	800 x 320 mm	10
						14399	1000 x 360 mm	10

SQUARE

ALU



No.	specification	
14450	190 x 355 mm	6
14451	200 x 405 mm	6



SQUARE



No.	specification	
14410	300 x 200 mm	50
14411	600 x 400 mm	36

SQUARE



No.	specification		No.	specification	
14455	300 x 200 mm	50	14457	700 x 300 mm	40
14456	500 x 250 mm	50	14458	1000 x 450 mm	30

SQUARE FLAT

Zn

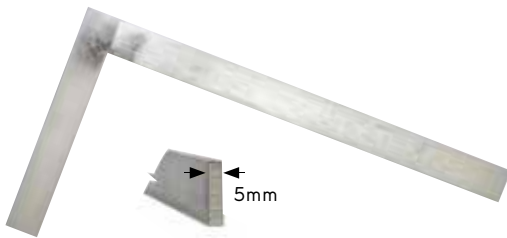

No.	specification	
14471	150 x 100 mm	25
14472	250 x 125 mm	25
14473	400 x 200 mm	30
14474	600 x 300 mm	25

SQUARE

Zn

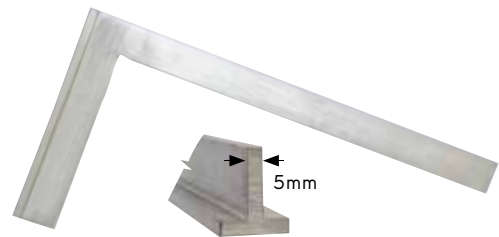

No.	specification	
14490	100 x 50 mm	10
14491	150 x 75 mm	10
14492	250 x 125 mm	10
14493	400 x 200 mm	10
14494	600 x 300 mm	10

TRY SQUARE

ALU

HOBBY



No.	specification	
14425	250 x 130 mm	12
14430	300 x 130 mm	12
14435	350 x 156 mm	12
14440	400 x 156 mm	12

BEVEL SQUARE WOODEN

MADE IN EU

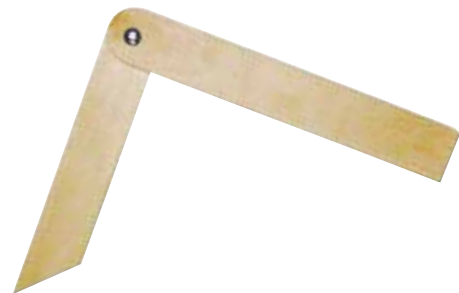

No.	specification	
14025	255 x 285 mm	1

CONTOUR DUPLICATOR TEMPLATE



lock



No.	specification	
14090	125 x 30 mm	1
14091	250 x 30 mm	1

HORIZONT[®] EXACTA

Precise levels
with highest measuring accuracy

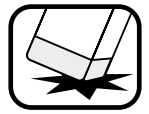
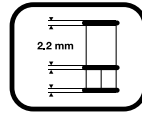
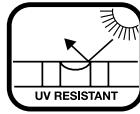
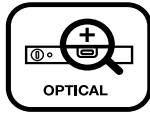
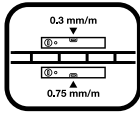

Every piece is electronically tested and has its evidence number, the producer is the holder of certificate ISO 90001



LEVEL EXACTA, 2 VIALS

HORIZONT[®]

ALU



No.	specification
15033	60 cm



10

LEVEL EXACTA, 3 VIALS

HORIZONT[®]

ALU



No.	specification
15034	80 cm
15035	100 cm



10
10

LEVEL EXACTA, 3 VIALS, 2 HANDLES

HORIZONT[®]

ALU



No.	specification
15036	120 cm
15037	150 cm
15039	200 cm



10
10
10

HORIZONT®

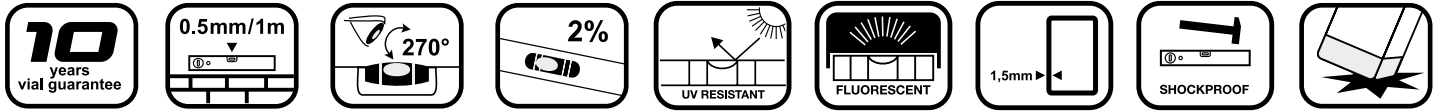

Every piece is electronically tested and has its evidence number, the producer is the holder of certificate ISO 90001



LEVEL, 2 VIALS



No.	specification	
15003	30 cm	30
15004	40 cm	30
15005	50 cm	30
15006	60 cm	30
15008	80 cm	30
15010	100 cm	30
15012	120 cm	10
15015	150 cm	10
15018	180 cm	10
15020	200 cm	10

LEVEL, 3 VIALS



No.	specification	
15103	30 cm	30
15104	40 cm	30
15105	50 cm	30
15106	60 cm	30
15108	80 cm	30
15110	100 cm	30
15112	120 cm	10
15115	150 cm	10
15118	180 cm	10
15120	200 cm	10

LEVEL, 2 VIALS + MAGNET

HORIZONT



No.	specification	
15204	40 cm	30
15205	50 cm	30
15206	60 cm	30
15208	80 cm	30
15210	100 cm	30
15212	120 cm	10
15215	150 cm	10
15218	180 cm	10
15220	200 cm	10

GRADIENT LEVEL, 4 VIALS

HORIZONT

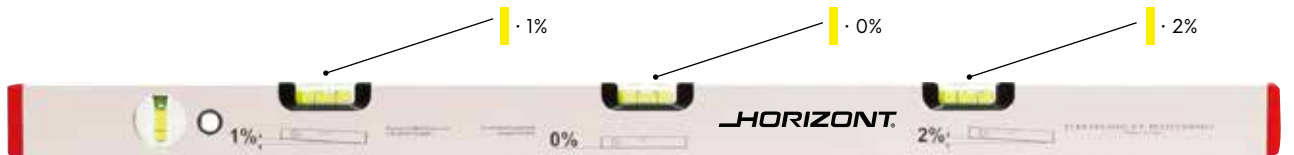

No.	specification	
15230	80 cm	10

GRADIENT LEVEL, 1 VIAL

HORIZONT



No.	specification	
15235	60 cm	1

MASON STAFF

HORIZONT



No.	specification	
15310	100 cm	10
15315	150 cm	10
15318	180 cm	10
15320	200 cm	10
15325	250 cm	10
15330	300 cm	10
15335	350 cm	10
15340	400 cm	10

MASON STAFF, 1 VIAL

HORIZONT®

ALU



No.	specification	
15415	150 cm	10
15418	180 cm	10
15420	200 cm	10
15425	250 cm	10
15430	300 cm	10

MASON STAFF, 2 VIALS

HORIZONT®

ALU



No.	specification	
15510	100 cm	10
15515	150 cm	10
15518	180 cm	10
15520	200 cm	10
15525	250 cm	10
15530	300 cm	10
15535	350 cm	10
15540	400 cm	5

MASON STAFF, 2 HANDLES, WITHOUT VIALS

HORIZONT®

ALU



No.	specification	
15615	150 cm	10
15620	200 cm	10
15625	250 cm	10
15630	300 cm	10

MASON STAFF, 2 VIALS, 2 HANDLES

HORIZONT®

ALU



No.	specification	
15710	100 cm	10
15715	150 cm	10
15720	200 cm	10
15725	250 cm	10
15730	300 cm	10
15735	350 cm	10
15740	400 cm	5



PROFILE TRAPEZOIDAL
 · trapezoidal profile for finer surface finishes
 · suitable for stuccoers and facades
 · suitable for thin-film plasters



PROFILE "h"
 · "h" profile for finer surface finishes
 · suitable for stuccoers and facades
 · suitable for stucco plastering



MASON STAFF, TRAPEZ



ALU



No.	specification	
15810	100 cm	10
15812	120 cm	10
15815	150 cm	10
15818	180 cm	10
15820	200 cm	10
15825	250 cm	10
15830	300 cm	10

MASON STAFF, "h" PROFIL



ALU



No.	specification	
15850	100 cm	10
15853	150 cm	10
15855	180 cm	10
15860	200 cm	10
15870	250 cm	10
15880	300 cm	10

STAND FOR LEVEL HORIZONTAL



· items in stand 15998

- 15003 · 5 ks | pcs
- 15004 · 5 ks | pcs
- 15005 · 5 ks | pcs
- 15006 · 5 ks | pcs
- 15008 · 5 ks | pcs
- 15010 · 5 ks | pcs
- 15012 · 5 ks | pcs
- 15015 · 3 ks | pcs
- 15018 · 3 ks | pcs
- 15020 · 3 ks | pcs
- 15108 · 3 ks | pcs
- 15206 · 3 ks | pcs
- 15210 · 3 ks | pcs

No.	specification	
15999	85 x 210 x 50 cm	1
15998	85 x 210 x 50 cm filled with items	1

STAND FOR LEVEL AND MASONRY STAFF HORIZONTAL



· items in stand 15996

- 15004 · 5 ks | pcs
- 15005 · 5 ks | pcs
- 15006 · 5 ks | pcs
- 15008 · 5 ks | pcs
- 15010 · 5 ks | pcs
- 15012 · 5 ks | pcs
- 15015 · 5 ks | pcs
- 15018 · 5 ks | pcs
- 15020 · 5 ks | pcs
- 15315 · 2 ks | pcs
- 15320 · 2 ks | pcs
- 15325 · 3 ks | pcs
- 15515 · 2 ks | pcs
- 15520 · 2 ks | pcs
- 15525 · 3 ks | pcs

No.	specification	
15997	55 x 75 x 40 cm	1
15996	55 x 75 x 40 cm filled with items	1

- Accuracy 0,5 mm | 1 m (in the basic position)
- UV stable vials
- Shockproof rubber ends
- Profile thickness 2,4 mm



NIVELA LEVEL - 2 VIALS



· rubber ending



No.	specification	
15904	40 cm	30
15906	60 cm	30
15908	80 cm	30
15910	100 cm	30
15912	120 cm	20
15915	150 cm	10
15920	200 cm	20

NIVELA LEVEL - 3 VIALS



No.	specification	
15954	40 cm	60
15956	60 cm	60
15958	80 cm	60
15960	100 cm	30
15962	120 cm	30
15965	150 cm	30
15970	200 cm	30

DIGITAL INCLINOMETER



- 0° - 360°
- accuracy $\pm 0,1^\circ$
- resolution $0,1^\circ$
- auto-off function
- HOLD function for measured value storing
- backlight display
- dimensions 60x60x25 mm
- battery 1xAAA

· magnetic bottom side



No. specification
26218

1

DIGITAL LEVEL

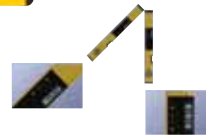

- accuracy 0,5 mm |m,
- resolution $0,1^\circ$
- HOLD function for measured value storing
- profile 1,8 mm

No. specification
26215 600 mm

1

DIGITAL PROTRACTOR



- LCD display
- measuring range
- resolution
- accuracy

0° - 360°
 $0,1^\circ$
 $\pm 0,3$



DIGITAL PROTRACTOR



- LCD display
- measuring range
- resolution
- accuracy

0° - 225°
 $0,1^\circ$
 $\pm 0,3$



No. specification
26217 200 mm

1



No. specification
26216 300 mm

1

CROSS LASER SA-08



- 650 nm
- 2x AA battery
- work. range 10 m

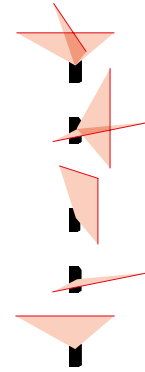

No.	specification
26205	



1

LEVEL TO HANG ON TWINE

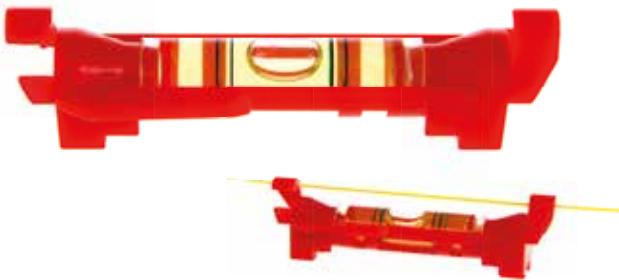

No.	specification
15981	



1

PLASTIC LEVEL, 3 VIALS+MAGNET



No.	specification
15980	230 mm



1

SPIRIT LEVEL FOR POLES



- 3 vials, magnets, fastening belt



No.	specification
26028	



12

GLASSPIPES WITH HOSE



No.	specification	
15992	glass pipes - hose 10 m	1
15993	glass pipes - hose 15 m	1
15990	glass pipes	50
15991	plastic pipes	50

CLIMAPILOT



Digital hygrometer for measuring relative humidity and ambient temperature with dew point indicator

- Practical device for monitoring room climate
- Digital display with max |min values
- Switch between ambient temperature |dew point



No.	specification	specification	specification	
	Ambient temperature measuring range:	0°C ... 50°C	Dew point temperature:	-28,6°C ... 47,9°C
26460	Accuracy:	±1°C	Accuracy:	±2°C
	Relative air humidity:	20% rH ... 90% rH	Inclusive:	battery
	Accuracy:	±5%rH (25%rH... 85% rH)		

MOISTUREFINDER COMPACT



Professional moisture measurement of materials – fast and non-destructive

- Non-destructive measurement of material moisture by capacitive measurement. The tested material is not damaged.
- Simple to use: select material type then place the instrument on the material's surface to determine moisture content in %.
- 4 selectable material characteristics: soft woods (e.g. spruce, pine, linden), hard woods (e.g. beech, oak, birch), gypsum plaster and cement screed
- LED wet |dry indicator provide immediate measurement results for moisture content in the tested material.



No.	specification:	specification:
	Cement screed:	0% ... 5%
26527	Plaster:	0% ... 23%
	Soft wood:	0% ... 52%
	Hard wood:	0% ... 32%

DAMPFINDER COMPACT



Universal device for testing moisture in wood and building materials

- For ascertaining moisture in building materials and for quick checks when working with wood
- Triple scale for wood groups A, B and universal index mode
- Numerical display of measured value and ambient temperature
- Illuminated, transparent display



No.	specification	specification
26464	Wood:	0% ... 30% ± 1%, 30% ... 60% ± 2%
	Other materials:	± 0,5 %
	Inclusive:	protective cap with self-test function, battery

LUXTEST-MASTER

Laserliner®



Professional lighting intensity measuring instrument

- Measurement of lighting intensity in workplaces, offices, public buildings and industry
- Sensitive photodiode with cosine correction for wide-angle light measurement
- Relative measurement function for reference and comparison measurement
- Peak function for registering fast changes in light levels
- Hold function
- Automatic and manual range changeover
- Zeroing function
- Measurement variables: Lux (lm | m²), foot candle (lm | ft²)
- Min |Max display
- 1 |4" tripod connection

No.	specification
	Measuring range : 20 Lux ... 200000 Lux
26520	Lux accuracy: ± 3% (reference light bulb at 2854 K)
	Cosine angular deviation: ± 2% (30°), ± 6% (60°)



specification
Inclusive: battery, carrying case

AIRFLOWTEST-MASTER

Laserliner®



Professional anemometer for measuring air flow, volumetric flow and wind speed

- Integrated sensor for measuring ambient temperature, relative humidity and dew point calculation
- USB interface for saving measured data
- PC software for real-time logging
- Large impeller: 65 mm
- Min |Max display
- 1 |4" tripod connection for long-term measurement
- Illuminated, clearly arranged display with permanently visible ambient temperature and relative humidity

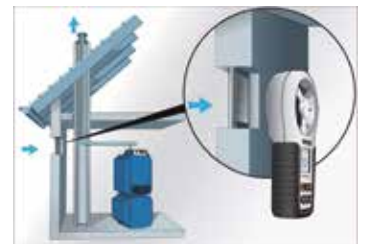

No.	specification
	Flow rate: 0.80...30 m s ± 2%
26521	Ambient temperature: -10...60°C ± 1.5°C
	Relative humidity: 20%...80% ± 3%
	Airflow: 0...99990 CMM

i RECORDING ON A PC

specification
Inclusive: PC software, USB Cable, batteries, carrying case



ACTIVEPEN

Safe non-contact voltage check

- Locates electrical voltages in cables, sockets, bulb sockets and fuses
- Determines polarity of L | N conductors, e.g. on sockets or terminals
- Finds breaks in wires and cables
- Clearly visible LED

Laserliner®

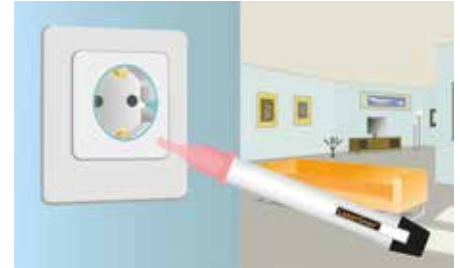

specification	
Inclusive:	battery
No.	specification
26479	Voltage range: 200 V A ... 600 V AC, frequency: 50 ... 60Hz



AC-TRACER

Laserliner®



Cable tracer set with transmitter and receiver

- Non-contact tracing of the transmission signal by the receiver
- Fast tracing of coherent electrical circuits
- Location of lines in coherent, live electrical circuits
- Detection of fuse circuits in live installations
- Receiver with audible signal tone for locating measured objects
- Receiver with adjustable sensitivity for optimum fine adjustment
- Socket adapter for direct and fast testing in building installations.
- E27 lamp adapter for direct and fast testing in lamp circuits



No.	specification
26343	Inclusive: receiver RECV, EURO connector, UK-plug (Great Britain), E27 Lamp adapter, battery, carrying case



THERMOSPOT LASER

Laserliner®



Non-contact infrared temperature instrument with integrated laser

- The non-contact measuring method is ideal for measuring temperature in places difficult to access as well as for hazardous applications such as moving machine parts or electrical installations
- The 8-point laser circle pinpoints the measuring zone exactly
- measuring range: -38°C - 360°C
- Emission ratio: 0.95
- Lens: 12:1



No. specification

26260 Inclusive: battery

1

CONDENSESPOT PLUS

Laserliner®



Infrared thermometer for locating thermal bridges and condensation moisture

- 8-point laser circle pinpoints the measuring zone exactly
- Measurement of surface | dew point temperature
- Localisation of condensation in thermal bridge mode with dew point display
- Localisation of thermal bridges and condensation water issues in thermal bridge mode with dew point display
- Temperature measurement range (-40°C...365°C)
- Emission ratio: 0.01...1.0 (adjustable)
- Colour alarm function: Thermal bridge warning with colour display
- Quick selection of 5 emissivity defaults with Fast Preset or exact setting by entering numerical value
- Bar graph condense water indicator
- Lens 12:1, illuminated display

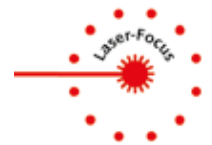

No. specification

	Measuring range of infrared ray:	-40°C . . . 365°C
	Accuracy:	± -40°C ... 0°C (± (1°C + 0,1°C 1°C)) 0°C ... 30°C (± 1°C or ± 1%, depending on the higher value) >30°C (± 2°C or ± 2%, depending on the higher value)
26528	Ambient temperature: Accuracy	-20°C...65°C ± 1°C (0°C...50°C) ± 2,5°C (<0°C and >50°C)
	Air humidity (relative): Accuracy	1%...99% ± 3% (20%...80%) ± 5% (<20% and >80%)
	Inclusive:	batteries

MULTIFINDER PLUS

Laserliner®



Universal detector for locating wood, metal, copper, iron and live wires

- One-button operation to switch between the different measurement modes
- The user guide on the LC display makes the device easy and reliable to use
- Auto-Calibration: adjusts the device to different surfaces immediately after switching on
- Auto-Cal Plus: allows objects to be localized easily in Metal-Scan mode
- Acoustic and visual detection signals for finding objects
- High safety is guaranteed by the permanent voltage warning function
- Illuminated display
- Special feature: in metal mode, it is even able to detect concealed lines when they are not live



AUTO CALIBRATION



1

No. specification

26431 Inclusive: battery

STARFINDER PLUS

Laserliner®



Electronic detector for live supply lines as well as wall beams and joists in drywall structures

- One-button operation to switch between the different measurement modes
- Auto-Calibration: adjusts the device to different surfaces immediately after switching on
- Acoustic and visual detection signals for finding objects
- Illuminated display

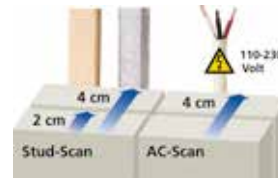

AUTO CALIBRATION



1

No. specification

26429 Inclusive: battery

COMBIFINDER PLUS

Laserliner®



Electronic detector for metal and live wires

- This device permits targeted scanning for metals such as reinforcing iron, heating pipes and water pipes
- One-button operation to switch between the different measurement modes
- The user guide on the LC display makes the device easy and reliable to use
- Auto-Calibration: adjusts the device to different surfaces immediately after switching on
- Auto-Cal Plus: allows objects to be localized easily in Metal-Scan mode
- Acoustic and visual detection signals for finding objects
- High safety is guaranteed by the permanent voltage warning function
- Illuminated display



AUTO CALIBRATION



1

No. specification

26430 Inclusive: battery

VIDEOSCOPE ONE

Laserliner®

DISPLAY 2,7 LCD 320 x 240 pixel

ZOOM 2x

4x AA

IP 67

LED light

1,5m
Ø 9 mm

Compact inspection camera for visual inspections of areas which are difficult to access

- The camera head on the flexible cable transmits images directly to the LC monitor
- Powerful object lighting thanks to 4 high-performance LEDs
- 2x digital zoom in 10% increments
- DOF: Focal depth 3...7 cm
- Connection of external monitors via TV Out
- The compact camera head is small enough to inspect even inaccessible areas.
- Manual image rotation by 180° on the monitor
- Camera head: ø 9 mm



1

No. specification

26523 Inclusive: VideoScope One 1,5 m, battery

DISTANCECHECK

Laserliner®



Laser distance meter – simple operating techniques

- Measuring range, internal 0.05 to 20 m
- Measuring precision of ± 2 mm (typical)*
- The area and volume functions permit the acquisition of room sizes, for example to calculate material quantities
- Continuous Min. |Max. measurement
- Illuminated flip-display rotates about 180°



No. specification

26524 Inclusive: battery

1

LASERRANGE-MASTER T3

Laserliner®



Laser distance meter – with angle function

- The area and volume functions permit the acquisition of room size, for example to calculate material quantities
- Pythagoras 1 + 2, angle function 1 + 2, continuous measurement
- 360° inclination sensor for determining the horizontal and vertical distance
- 1/4" thread
- Illuminated 3-line colour LCD with touch function



No. specification

26395 Inclusive: bag, battery

1

COMPACTCROSS - LASER PLUS

Laserliner®



The automatic cross-line laser for aligning tiles, wall studding, windows, doors etc.

- The slope-mode feature is an extra that permits gradients to be laid out.
- RX-ready: integrated hand-held receiver mode
- Bluetooth® interface for remote control of the device
- Automatic levelling range 4°, Accuracy 0,35 mm |m



No. specification

26037 Inclusive: battery

1

SMARTCROSS-LASER

Laserliner®



Automatic cross-line laser with additional slope function

- 5° self-levelling range, accuracy 0,5 mm | 1 m
- Slope function is an additional feature that permits gradients to be laid out.
- Out-Of-Level is indicated by optical signals when the unit is out of its self-levelling range
- Simple, uniform operating techniques



Laser 650nm



No. specification

26440 Inclusive: SmartCross-Laser, battery

1

FLEXCLAMP

Laserliner®



Universal clamp

- Suitable for all laser measuring devices with 1/4" threads
- Versatile damage free mounting options for surfaces
- Height and position of the measuring device easily adjustable



No. specification

26441 FlexClamp

1

AUTOCROSS - LASER 3C PLUS

Laserliner®



Cross-line laser vertical and horizontal alignment

- The pivoted housing can be turned with a vernier adjustment mechanism to permit exact positioning of laser lines
- Adjustable feet with removable rubber caps
- Automatic levelling range 2,5°, accuracy 0,2 mm | m
- A simple, precise plumb function is afforded by the additional plumb laser at the bottom and the laser cross at the top
- The vertical lines are aligned at right angles to one another



Laser 635nm



No. specification

26526 Inclusive: batteries

1

SUPERSQUARE-LASER 4

Laserliner®



90° line laser – ideal for laying wall and floor tiles

- Angle accuracy 0.5 mm | 1 m
- The 4 clearly visible laser lines are ideally suited for aligning tiles.
- Vertical and horizontal levelling on walls
- The moving pointer shows the exact start and end positions
- Metering wheel with 0.5 m circumference



No. specification

26495 Inclusive: pins, batteries

1

HANDYLASER PLUS

Laserliner®



Compact universal laser spirit level 90° pentaprism Mag

- Combines the advantages of a laser spirit level in outstandingly compact dimensions
- Vial accuracy 0.5 mm | 1 m
- Vertical levelling
- With high-precision prism

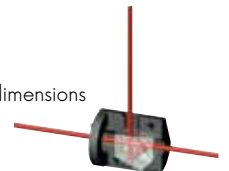

No. specification

26493 Inclusive: Adjustable stand, 90°pentaprism, batteries

1

LASER ENHANCEMENT GLASSES

Laserliner®



No. specification

26021 red



1

STEEL PENCIL WITH CLIP HB



No.	specification	
13262	150 mm	20
13263	spare graphite 6 pcs	20

PENCIL WITH REMOVABLE GRAPHITE HB

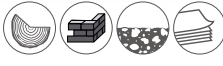

No.	specification	
13279	pencil + graphite HB	24
13284	spare graphite 5 pcs	20

CARPENTER PENCILS HB

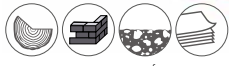

No.	specification	
13270	HB · 180 mm	96
13271	HB · 180 mm · set 3 pcs	32
13265	HB · 250 mm	96

CARPENTER PENCIL HB

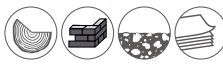

No.	specification	
13269	HB · 180 mm	50
13266	HB · 250 mm	50

CARPENTER PENCIL HB

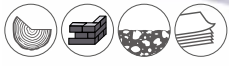

No.	specification	
13272	HB · 250 mm	96
13264	HB · 250 mm · without print	96

CARPENTER PENCIL HB

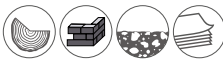

No.	specification	
13268	250 mm	50

TRIANGULAR PENCIL HB



No.	specification	
13278	250 mm	96

CARPENTER PENCIL HB

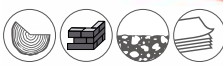

No.	specification	
13280	180 mm	96

PENCIL 6H



No. specification
13275 6H · 250 mm

MOQ
12



96

PENCIL FOR GLASS, CERAMICS



No. specification
13273 175 mm red graphite - glass, ceramics

MOQ
12



144

PENCILS WITH COLORFULL GRAPHITE



No. specification
13274 175 mm, red - blue

MOQ
12



96

PENCILS WITH RED GRAPHITE



No. specification
13276 175 mm

MOQ
12



144

PENCIL SHARPENER



· sanding paper

No.
13261



12

WHITE CHALK

12x



No. specification
13260 12 x 12 x 80 mm



46

UNIVERSAL MARKER SET 5 PCS



5x



· Ø 13 x 110 mm

No.	specification	
13240	5 colours	20
13241	red	20
13242	black	20

No.	specification	
13243	yellow	20
13244	green	20
13245	white	20



20
20
20

WAX CRAYON SET 6 PCS

6x



No. specification
13277



88

PERMANENT MARKER



- extra strong tip
- for marking even on greasy and wet surfaces



MOQ
12

No.	specification	
13216	red	12
13217	black	12
13218	blue	12
13219	green	12



PERMANENT MARKER



- 2 types of markers tip
- for marking even on greasy and wet surfaces



No.	specification	
13227	white ALU pen body	40
13222	white PVC pen body	12
13228	red ALU pen body	40
13229	black ALU pen body	40
13230	blue ALU pen body	12
13231	green ALU pen body	12



PERMANENT MARKER



MOQ
12

No.	specification	
13214	white	12
13225	red	12
13226	black	12
13223	blue	12
13224	green	12



PERMANENT MARKER



MOQ
12

No.	specification	
13235	red	12
13236	black	12
13237	blue	12
13238	green	12



TWO SIDED PERMANENT MARKER - DIFFERENT THICKNESS



ø 0,5 mm

No. specification

13212 black

MOQ 12

12

PERMANENT MARKER MINI

· length of marker 9 cm



No. specification

13205

MOQ 72

72

MARKING TOOL



No. specification

13281 150 mm

50

DRAWING-COMPASS



No. specification

13285 200 mm

10

MARKING TOOL



No. specification

13282 200 mm

50



SPRAY FLUORESCENT TRACKMARKER 500 ML



- High visibility due to fluorescent pigment
- Safety cap
- Quick drying 10 min.
- Durability 3 months
- Use - Concrete, Asphalt, Grass, Gravel, Sand, Stone, Wood



No.	specification	
13250	● yellow	12
13251	● red	12
13252	● orange	12
13253	● green	12
13254	● pink	12
13249	● blue	12

SPRAY FLUORESCENT MARK 6M FLUO 500 ML



- High visibility due to fluorescent pigment
- Safety cap
- Quick drying 10 min.
- Durability 6 months
- Use - Concrete, Asphalt, Grass, Gravel, Sand, Stone, Wood, Glass



No.	specification	
13360	● yellow	12
13361	● red	12
13362	● orange	12
13363	● green	12
13364	● pink	12
13365	○ white	12

SPRAY FLUORESCENT FLUO 500 ML



- High visibility due to fluorescent pigment
- Safety cap
- Quick drying 10 min.
- Durability 12 months
- Use - Concrete, Asphalt, Grass, Gravel, Sand, Stone, Wood, Glass



No.	specification	
13350	● yellow	12
13351	● red	12
13352	● orange	12
13353	● green	12
13354	● pink	12
13355	○ white	12

SPREY FLUORESCENT IDEAL 500 ML



- High visibility due to fluorescent pigment
- Safety cap
- Quick drying 10 min.
- Durability 12 months
- Use - Concrete, Asphalt, Grass, Gravel, Sand, Stone, Wood



No.	specification	
13255	● yellow	12
13256	● red	12
13257	● orange	12
13258	● green	12
13259	● pink	12

MOBILE SPREY HOLDER FOR SPRAY SOPPEC



- For spray trackmarker and Fluo

No.	specification	
13296		1















PISTOL SPREY HOLDER FOR SPRAY SOPPEC



- For spray trackmarker and Fluo

No.	specification	
13295		1

	40		44		47
PLIERS		WRENCHES		BOLT CUTTER	
	48		51		59
TINSMITH PLIERS		GOLA SETS AND RATCHETS		HEADS, EXTENSIONS, ADAPTERS	
	65		71		78
SPANNERS		SCREWDRIVERS		BITS	
	84		89		93
HEX KEY SETS		HAMMERS, MALLETS		RUBBER MALLETS	

WORKSHOP TOOLS

38 - 133



95

AXES



97

CHISELS



98

CHISELS



101

STAPLE GUNS



107

CLAMPS AND VICES



109

WORK BENCHES



110

RIVETERS



114

WELDING

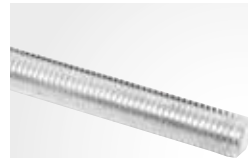

117

THREAD RODS, WASHER, NUTS



118

COMPRESSOR, BLOW AND SPRAY GUNS



123

SAFETY EQUIPMENTS



129

MOUNTING BELTS,BAGS AND CASES



ERGONOMIC handle

STANDARD +30% FESTA

COMBINATION PLIERS



CrV · chrom vanadium steel

DIN 5746

HRC 58-62 · jaw hardness



ERGO HANDLE · ergonomic handle made of TPE rubber

· inductively hardened

No.	specification	
17101	160 mm	6
17102	180 mm	6
17103	200 mm	6

SIDE CUTTING PLIERS



DIN 5749 **TUV GS**

CrV **HRC 58-62**



No.	specification	
17148	180 mm	6

SIDE CUTTING PLIERS



DIN 5749 **TUV GS**

CrV **HRC 58-62**



No.	specification	
17104	160 mm	6
17105	180 mm	6

RADIAL PLIERS STRAIGHT



DIN 5745 **TUV GS**

CrV **HRC 58-62**



No.	specification	
17140	160 mm	6
17141	180 mm	6
17142	200 mm	6

BENT NOSE PLIERS



DIN 5745 **TUV GS**

CrV **HRC 58-62**



No.	specification	
17145	160 mm	6
17146	200 mm	6

COMBINATION PLIERS

DIN 5746

FESTA

HRC 50-55



No.	specification	
17001	160 mm	6
17002	180 mm	6
17003	200 mm	6

SIDE CUTTING PLIERS

DIN 5749

FESTA

HRC 50-55



No.	specification	
17004	160 mm	6
17005	180 mm	6

SIDE CUTTING PLIERS

DIN 5749

FESTA

HRC 50-55



No.	specification	
17108	180 mm	6

CUTTING FRONT PLIERS

DIN 5749

FESTA

HRC 50-55



No.	specification	
17110	160 mm	6

RADIAL PLIERS STRAIGHT

DIN 5745

FESTA

HRC 50-55



No.	specification	
17006	160 mm	6
17011	200 mm	6

PLIERS BENT NOSE

DIN 5745

FESTA

HRC 50-55



No.	specification	
17007	160 mm	6
17008	200 mm	6

FLAT NOSE PLIERS

DIN 5746

FESTA

HRC 50-55



No.	specification	
17009	160 mm	6

ROUND NOSE PLIERS

DIN 5745

FESTA

HRC 50-55



No.	specification	
17010	160 mm	6

WIRE STRIPER PLIERS

DIN 5744

FESTA

HRC 50-55



No.	specification	
17024	160 mm	6

COMBINATION PLIERS

DIN 5746



No.	specification	
17094	160 mm	6
17095	180 mm	6
17096	200 mm	6

SIDE CUTTING PLIERS

DIN 5749



No.	specification	
17097	160 mm	6
17098	180 mm	6

RADIAL PLIERS STRAIGHT

DIN 5745



No.	specification	
17099	160 mm	6
17100	200 mm	6

VDE COMBINATION PLIERS

DIN 5746

FESTA

CrV HRC 58-62



1000 V IEC/EN60900:2004

No.	specification	
17125	160 mm	6
17126	180 mm	6
17127	200 mm	6



VDE SIDE CUTTING PLIERS

DIN 5749

FESTA

CrV HRC 58-62



1000 V IEC/EN60900:2004

No.	specification	
17128	160 mm	6



VDE CABLE/WIRE CUTTERS

CrV HRC 58-62

FESTA



1000 V IEC/EN60900:2004

No.	specification	
17130	160 mm	6



VDE RADIAL PLIERS STRAIGHT

DIN 5745

FESTA

CrV HRC 58-62



1000 V IEC/EN60900:2004

No.	specification	
17133	160 mm	6



VDE BENT NOSE PLIERS

DIN 5745

FESTA

CrV HRC 58-62



1000 V IEC/EN60900:2004

No.	specification	
17135	160 mm	6



VDE ROUND NOSE PLIERS

DIN 5745

FESTA

CrV HRC 58-62



1000 V IEC/EN60900:2004

No.	specification	
17137	160 mm	6



VDE WIRE STRIPPER

FESTA

CrV DIN 5744



1000 V IEC/EN60900:2004

No.	specification	
17138	160 mm	6



CABLE STRIPPER AND CUTTER



No.	specification	
17180	∅ 0,75 - 2,5 mm	12



CABLE STRIPPER AND CUTTER



No.	specification	
17181	∅ 0,60 - 2,6 mm	10



MULTIFUNCTION PLIERS

CrV

FESTA



- 9 functions
- bag

No.	specification
16232	



PLIERS SET

4x



FESTA



No. specification

17040

6

COMBINATION PLIERS

FESTA



No. specification

17041 110 mm

12

SIDE CUTTING PLIERS MINI

FESTA



No. specification

17042 110 mm

12

END PLIERS MINI

FESTA



No. specification

17043 100 mm

12

LONG NOSE PLIERS MINI

FESTA



No. specification

17044 120 mm

12

ROUND NOSE PLIERS MINI

FESTA



No. specification

17045 120 mm

12

RING PLIERS

FESTA



No. specification

17190 180 mm inward

6

17191 180 mm outward

6

RING PLIERS

FESTA



No. specification

17192 180 mm inward

15

17193 180 mm outward

15

RING PLIERS



No. specification

17025 set

10

MULTIFUNCTION FENCE PLIER

CrV



No. specification

17109 270 mm

4

• for fence

WATER PUMP PLIERS



CrV



No.	specification	range of jaw	
17059	180 mm	0 - 30 mm	6
17061	250 mm	0 - 30 mm	6
17062	300 mm	0 - 40 mm	10
17080	400 mm	0 - 84 mm	10

WATER PUMP PLIERS SELF ADJUSTABLE



CrV



No.	specification	range of jaw	
17079	250 mm	0 - 50 mm	6

WATER PUMP PLIERS



CrV



· large range of jaws

No.	specification	range of jaw	
17086	250 mm	0 - 45 mm	6

WATER PUMP PLIERS



CrV



No.	specification	range of jaw	
17081	180 mm	0 - 30 mm	6
17014	250 mm	0 - 30 mm	6
17082	300 mm	0 - 50 mm	6

WATER PUMP PLIERS



CrV



No.	specification	range of jaw	
17084	250 mm	0 - 30 mm	6

WATER PUMP PLIERS



CrV



No.	specification	range of jaw	
17012	250 mm	0 - 40 mm	6
17060	300 mm	0 - 50 mm	10

WATER PUMP PLIERS



CrV



No.	specification	range of jaw	
17013	250 mm	0 - 30 mm	6
17033	NEW 300 mm	0 - 50 mm	6

PLASTIC JAW PROTECTOR FOR PLIERS



· suitable for 17061, 17079, 17086

No.	specification		
17085	1 pair		1

WRENCH 45°, S



CrV



No.	specification	
17067	1" 330 mm	25
17068	1,5" 420 mm	18
17069	2" 540 mm	8

PIPE WRENCH 90°



CrV



No.	specification	
17075	1" 330 mm	24
17076	1,5" 420 mm	20
17077	2" 540 mm	10

WRENCH 90°



CrV



No.	specification	
17070	2,5" 355 mm	12
17071	3" 455 mm	8
17072	3,5" 610 mm	10

ADJUSTABLE WRENCH



WRENCH

CrV



No.	specification		No.	specification	
17063	230 mm	6	17065	260 mm	36
17064	300 mm	6	17066	300 mm	36

QUICK GRIP WRENCH

NEW



No.	specification
17034	220 mm

5

QUICK GRIP WRENCH



No.	specification
17036	260 mm

5

QUICK GRIP WRENCH



No.	specification
17035	220 mm

10

QUICK GRIP WRENCH



No.	specification
17023	220 mm

6

CARPENTER PINCERS

FESTA

CrV



No.	specification
17300	160 mm
17301	180 mm
17302	200 mm

6

6

6

RABIT PINCERS

FESTA

CrV



No.	specification
17305	220 mm
17304	275 mm

10

6

CARPENTER PINCERS



No.	specification
17015	160 mm
17016	180 mm
17017	200 mm

6

10

7

RABIT PINCERS



No.	specification
17019	220 mm
17083	275 mm

7

6

BOLT CUTTER PROFESSIONAL



Cr-Mo

HRC 58-62



• jaws for cables and wires



No.	specification	max. Ø of wire	max. Ø of rope	max. Ø of cable	
17055	14' 360 mm	max. 5 mm < 45 HRC	max. 3,5 mm	max. 8 mm	1
17056	18' 460 mm	max. 6 mm < 45 HRC	max. 5 mm	max. 10 mm	1
17057	24' 610 mm	max. 8 mm < 45 HRC	max. 7 mm	max. 12 mm	1
17058	30' 760 mm	max. 10 mm < 45 HRC	max. 9 mm	max. 14 mm	1
17046 NEW	35' 900 mm	max. 12 mm < 45 HRC	max. 10 mm	max. 16 mm	1

BOLT CUTTER PROFESSIONAL



BOLT CUTTER

Cr-Mo

HRC 58-62



No.	specification	max. Ø of wire	
17051	14' 360 mm	max. 5 mm < 45 HRC	20
17052	18' 450 mm	max. 6 mm < 45 HRC	10
17053	24' 610 mm	max. 8 mm < 45 HRC	8
17054	30' 760 mm	max. 10 mm < 45 HRC	5
17048	36' 910 mm	max. 12 mm < 45 HRC	1



No.	specification	max. Ø of wire	
17028	14' 350 mm	max. 5 mm < 30 HRC	30
17020	18' 450 mm	max. 6 mm < 30 HRC	6
17021	24' 610 mm	max. 8 mm < 30 HRC	10
17022	30' 760 mm	max. 10 mm < 30 HRC	5

CUTTING PLIERS FOR WIRE ROPES



CUTTING PLIERS



BOLT CUTTER

CrV

**max. Ø
6 mm**

- steel wires
- ACSR cables
- aircraft cable

CrV

**max. Ø
12 mm**

- steel wires
- ACSR cables
- aircraft cable

**max. Ø
5 mm**



No.	specification	
17029	200 mm	6



No.	specification	
17039	24' 610 mm	8



No.	specification	
17038	8' 210 mm	6

TINSMITH PLIER

NEW

FESTA



No.	specification
17089	150 x 215 mm



TINSMITH PLIER

FESTA

TINSMITH PLIER

FESTA



No.	specification
17093	95 x 270 mm



6



No.	specification
17090	60 x 280 mm



10

TINSMITH PLIER 45°

FESTA

TINSMITH PLIER 90°

FESTA



No.	specification
17091	60 x 280 mm



10



No.	specification
17092	60 x 260 mm



10

TINMANS SNIPS PLIERS

FESTA

TINMANS SNIPS

FESTA

Cr-Mo

Cr-Mo

HRC 58-62

HRC 58-62



No.	specification		
17112	straight	40 260 mm	6
17117	right	40 260 mm	6
17122	left	40 260 mm	6



No.	specification		
17111	straight	40 250 mm	6
17116	right	40 250 mm	6
17121	left	40 250 mm	6

SNIPS

CrV

FESTA



No.	specification	
17170	50 250 mm	6

SNIPS

CrV

FESTA



No.	specification	
17156	60 245 mm	6

SNIPS

CrV

FESTA



No.	specification	
17155	70 260 mm	6

SNIPS

CrV



No.	specification	
17167	70 300 mm	5

SNIPS

CrV



No.	specification	
17165	60 250 mm	5

SNIPS

CrV



No.	specification	
17169	35 250 mm	5

HAND NIBBLER

max 0,8 mm



No.	specification	
17186	265 mm	1

ADAPTER FOR CUTTING PLATE - NIBBLER



Ø 8mm

Ø 4mm



Max plate thickness:
 · 1,8 mm - steel
 · 1,2 mm - stainless
 · 2 mm - plastic, aluminium, copper

No.	specification	
20363		5

LEVER SHEARS

	17175	17177
max. 4mm	max. 4mm	5mm
max. ø10mm	max. ø10mm	ø12mm
max. 8x8mm	max. 8x8mm	10x10mm

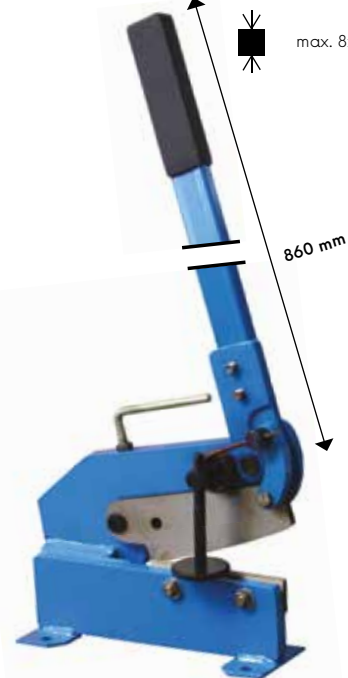

860 mm



No.	specification	
17175	150 mm	1
17177	250 mm	1

PUNCHING TONGS



No.	specification	
17185	Ø 2; 2,5; 3; 3,5;4; 4,5 mm	12

PLIERS FOR THE PROFILE



· Use for: plinths, profiles, tubes

No.	specification	
17050	60 220 mm ø 16 mm, ø 19 mm, ø 25 mm	8

SCISSORS



No.	specification	
16420	60 200 mm	10

SCISSORS



No.	specification	
17159	65 220 mm	12

SCISSORS



No.	specification	
17158	50 150 mm	10

SCISSORS SET



3x



No.	specification	
16401	3 pcs set	12

SCISSORS



No.	specification	
17160	70 210 mm	12

SCISSORS



No.	specification	
16405	14 cm	24
16406	17 cm	24
16407	19 cm	24
16408	21,5 cm	12

FESTA®

10 years
guarantee

- For industry and services
- High quality Chrom Vanadium steel
- Ratchet with 72 teeth for the most precise work
- All components according to DIN norm
- Knurled heads for better grip
- Strong plastic or metal case



made by

HONITON

SOCKET SET

CrV

1/2"

13x



- 1/2" · 72 T
- 1/2" · 125 mm
- 1/2" · 8-9-10-11-12-13-14-15-17-19-22 mm

FESTA®
made by
HONITON

10 years
guarantee

No. specification

17210



1

SOCKET SET

CrV

1/4"

17x



- 1/4" · 72 T
- 1/4" · 50 mm, 100 mm
- 1/4"
- 1/4"
- 1/4" · 4-4,5-5-5,5-6-7-8-9-10-11-12-13 mm

FESTA®
made by
HONITON

10 years
guarantee

No. specification

17211



1

SOCKET SET

CrV
1/2"
25x



- 1/2"
- 1/2" · 125 mm, 250 mm
- 1/2"
- 16 mm, 21 mm
- 1/2"
- 1/2" · 10-11-12-13-14-15-16-17-18-19-20-21-22-23-24-27-30-32 mm

FESTA
made by
HONLTON



No. specification
17212



4

SOCKET SET

CrV
1/2"
1/4"
59x



- 1/2", 1/4" · 72 T
- 1/2", 1/4"
- 1/4" · 150 mm
- 1/4" · 100 mm
- 1/2", 1/4"
- 1/2" · 125 mm, 250 mm
- 1/4" · 4-4,5-5-5,5-6-7-8-9-10-11-12-13 mm
- 1/2" · 10-11-12-13-14-15-17-19-21-22-24-27-30-32 mm
- 16 mm, 21 mm
- 18x
Inbus 3x

FESTA
made by
HONLTON



No. specification
17214



4

SOCKET SET

CrV
1/2"
28x



- 1/2" · 72 T
- 1/2" · 125 mm, 250 mm
- 1/2"
- 16 mm, 21 mm
- 1/2"
- 1/2"
- 1/2" · 8-9-10-11-12-13-14-15-16-17-18-19-20-21-22-23-24-27-30-32 mm

FESTA
made by
HONLTON



No. specification
17213



4

SOCKET SET

CrV
1/4"
16x



- 1/4" · 72 T
- 1/4" · 50 mm
- 1/4"
- 1/4"
- 1/4" · 4-4,5-5-5,5-6-7-8-9-10-11-12-13 mm

FESTA
made by
HONLTON



No. specification
17215



1

SOCKET SET

CrV

1/2"

25x



- 1/2" · 72 T
- 1/2" · 125 mm, 250 mm
- 1/2"
- 16 mm, 21 mm
- 1/2"
- 1/2" · 10-11-12-13-14-15-16-17-18-19-20-21-22-23-24-27-30-32 mm

FESTA
made by
HENITON



10

No. specification

17216

SOCKET SET

CrV

1/4"

32x



- 1/4" · 72 T
- 1/4" · 50 mm
- 1/4"
- 1/4"
- 1/4"
- 1/4" · 4-4,5-5-5,5-6-7-8-9-10-11-12-13 mm
- 12x
- Inbus 3x

FESTA
made by
HENITON



1

No. specification

17217

SOCKET SET

CrV

1/4"

1/2"

56x



- 1/2", 1/4" · 72 T
- 1/2", 1/4"
- 1/4" 150 mm
- 1/4" 100 mm
- 1/2", 1/4"
- 1/2" · 125 mm, 250 mm
- 1/4" · 4-4,5-5-5,5-6-7-8-9-10-11-12-13 mm
- 1/2" · 10-11-12-13-14-15-17-19-21-22-24-27-30-32 mm
- 16 mm, 21 mm
- 16x
- Inbus 3x

FESTA
made by
HENITON



4

No. specification

17218

SOCKET SET

CrV

1/4"

1/2"

94x



- 1/2", 1/4" · 72 T
- 1/2", 1/4"
- 1/4"
- 1/4" · 50 mm, 100 mm
- 1/2", 1/4"
- 1/2", 1/4"
- 1/2" 125 mm, 250 mm
- 1/4" · 4-4,5-5-5,5-6-7-8-9-10-11-12-13-14 mm
- 1/2" · 10-11-12-13-14-15-17-19-21-22-24-27-30-32 mm
- 1/4" · 6-7-8-9-10-11-12-13 mm
- 1/2" · 14-15-17-19-22 mm
- 16 mm, 21 mm
- 34x
- Inbus 3x

FESTA
made by
HENITON



3

No. specification

17219









SOCKET SET

CrV

1/2"

27x



-  1/2" · 72 T
-  1/2" · 125 mm, 250 mm
-  1/2"
-  16 mm, 21 mm
-  1/2"
-  1/2" · 8-9-10-11-12-13-14-15-16-17-18-19-20-21-22-23-24-27-30-32 mm

FESTA
made by
HUNTON



No. specification

17225



4





SOCKET SET

CrV

3/4"

14x



-  3/4" · 72 T
-  3/4" · 100 mm, 200 mm
-  3/4" · 460 mm
-  3/4" · 22-24-27-30-32-36-38-41-46-50 mm

FESTA
made by
HUNTON



No. specification

17226



1





SOCKET SET

CrV

3/4"

21x

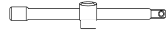

-  3/4" · 72 T
-  3/4" · 100 mm, 200 mm, 400 mm
-  3/4" · 460 mm
-  3/4" · 19-21-22-23-24-26-27-29-30-32-35-36-38-41-46-50 mm

FESTA
made by
HUNTON



No. specification

17227



1

SET OF SOCKET BITS HEX

CrV

1/2"

9x



FESTA
made by
HUNTON



SET OF SOCKET BITS TORX

CrV



1/2"

9x



FESTA
made by
HUNTON





-   1/2" HEX · 4-5-6-7-8 -10-12-14-17 mm

No. specification

17345



1

-   T20-T25-T27-T30-T40-T45-T50-T55-T60 mm

No. specification

17346



1

SET OF SOCKET

Cr-Mo

1/2"

3x



FESTA
made by
HUNTON



No.	specification	
17336	17 mm	5
17337	19 mm	5
17338	21 mm	5

SET OF SOCKET

Cr-Mo

1/2"

3x



FESTA
made by
HUNTON



No.	specification	
17335	1/2" · 17-19-21 mm	1

RATCHET

CrV



FESTA
made by
HUNTON



No.	specification	
17220	1/4" 36 teeth	20
17222	3/8" 36 teeth	10
17224	1/2" 36 teeth	6
17208	1/2" 72 teeth	6

SOCKET HEAD SET DRIVELOCK

CrV

1/4"

12x



FESTA
made by
HUNTON



No.	specification	
17250	4-5-5,5-6-7-8-9-10-11-12-13 mm	10



SOCKET HEAD SET TORX

CrV

1/2"

1/4"

9x



FESTA
made by
HUNTON



No.	specification	
17255	1/4" · 5-6-7-8-10	4
	1/2" · 12-14-16-18	

FESTA®

10 years
guarantee



Cr-Mo

- For use in industry and services
- High quality Chrom Vanadium steel
- Ratchet with 72 teeth for the most precise work
- All components by DIN norm
- Knurled heads for better grip
- Strong case with steel lockers and steel hinges



SET OF TOOLS

FESTA®

NEW

- CrV
- S2
- 1/4"
- 1/2"
- 72T
- 122x
- ERGO HANDLE



- | | |
|--|--|
| 1/2", 1/4" | 1/4" · S 4 · 5,5 · 6,5 |
| 1/4" · 4-5-6-7-8-9mm | 1/4" · PH 1 · 2 · 3 |
| 1/2" · 10-12-13-14-17-19mm | 1/4" · PZ 2 · 3 |
| 1/4" · 4-4.5-5-5.5-6-7-8-9-10-11-12-13-14mm | 1/4" · H 3 · 4 · 5 · 6 |
| 1/2" · 12-13-14-15-16-17-18-19-20-21-22-24mm | 1/4" · T 8 · 10 · 15 · 20 · 25 |
| 1/2", 1/4" | 1/4" · TTα 10 · 15 · 20 · 25 · 40 |
| 1/4" · → 1/4" | 2 · 2,5 · 3 · 4 · 5 · 6 · 7 · 8 · 10mm |
| 1/4" · 150mm | 8-9-10-11-12-13-14-15-16-17-18-19mm |
| 1/2" · 254mm | S 4x100 · 6,5x150 |
| 1/2", 1/4" | PH 2x100 · 3x150 |
| 1/2" · 16-21mm | 180mm |
| 1/4" · 150mm | 160mm |
| 1/2" · E10-E12-E14-E16-E18-E20-E22-E24 | 160mm |
| 1/4" · S 3 · 4 · 5 · 6 | 250mm |
| 1/4" · PH 0 · 1 · 2 | 300g |
| 1/4" · PZ 0 · 1 · 2 | |

No. specification
17238 122 ks



SOCKET SET

FESTA®

- CrV
- 1/2"
- 72T
- 12x
- ERGO HANDLE



- 1/2" · 72T
- 1/2" · 125 mm
- 1/2" · 10-11-12-13-14-15-17-19-22-24 mm



No. specification
17245 15

SOCKET SET

FESTA®

- CrV
- 1/2"
- 72T
- 12x
- ERGO HANDLE



- 1/2" · 72T
- 1/2" · 125 mm
- 1/2" · 10-11-12-13-14-15-17-19-22-24 mm



No. specification
17229 8

SOCKET SET



- CrV
- 1/2"
- 72T
- 20x
- ERGO HANDLE



- 1/2" · 72 T
- 1/2" · 75, 125 mm
- 1/2"
- 1/2" · 10-11-12-13-14-15-16-17-18-19-22-24 mm
- 1/2" · 17mm, 19mm
- 3 way adapter
- 16mm, 21mm



No. specification

17230

4

SOCKET SET



- CrV S2
- 1/4"
- 72T
- 36x
- ERGO HANDLE



- 1/4" · 72 T
- 1/4" · 50, 100 mm
- 1/4"
- 1/4" · 4-5-5,5-6-7-8-10-11-12-13 mm
- 1/4" · 6-7-8-10-12-13 mm
- 3 way adapter
- 4 x
- 11x
- 1x



No. specification

17231

10

SOCKET SET



- CrV S2
- 1/4"
- 72T
- 46x
- ERGO HANDLE



- 1/4"
- 1/4"
- 1/4" · 4-4,5-5-5,5-6-7-8-9-10-11-12-13-14 mm
- 1/4" · 50 mm, 100 mm
- 1/4"
- 1/4"
- 21 x
- 1/4"
- L 1/4"



No. specification

17233

10

SOCKET SET



- CrV S2
- 1/4"
- 1/2"
- 72T
- 73x
- ERGO HANDLE



- 1/2", 1/4" · 72T
- 1/4"
- 16 mm, 21 mm
- 1/4" · 10-11-12-13-14-15-16-17-18-19-20-21-22-23-24-27 mm
- 1/4" · 100 mm
- 1/2" · 125 mm, 250 mm
- 1/2"
- 1 x
- 1/4" · 4-5-5,5-6-7-8-10-11-12-13 mm
- 33 x



No. specification

17234

4

SOCKET SET



- CrV** **S2**
- 1/4"**
- 1/2"**
- 72T**
- 94x**
- ERGO HANDLE**



- 1/2", 1/4" · 72T
- 1/4"
- 16 mm, 21 mm
- 1/4" · 4 -4,5-5-5,5-6-7-8-9-10-11-12-13-14 mm
- 1/2" · 10-11-12-13-14-15-16-17-18-19-20-21-22-23-24-27-30-32 mm
- 1/4" · 6-7-8-9-10-11-12-13 mm
- 1/2" · 14-15-17-19 mm
- 1/4" · 50 mm, 100 mm
- 1/2" · 125 mm, 250 mm
- 1/4"
- 5/16" bit holder
- 17x
- 15x
- 3 way adapter
- 3 x
- 1/4"
- L 1/4"
- 1/2", 1/4"

No. specification

17235



SOCKET SET



- CrV** **S2**
- 1/4"**
- 1/2"**
- 72T**
- 110x**
- ERGO HANDLE**



- 1/2", 1/4" · 72T
- 150 mm
- 16 mm, 21 mm
- 1/4" · 4 -4,5-5-5,5-6-7-8-9-10-11-12-13-14 mm
- 1/2" · 10-11-12-13-14-15-16-17-18-19-20-21-22-24-27-30-32 mm
- 1/4" · 6-7-8-9-10-11-12-13 mm
- 1/2" · 14-15-17-19-22 mm
- 1/4" · 50 mm, 100 mm
- 1/2" · 125 mm, 250 mm
- E · 4-5-6-7-8-10-11-12-14-16-18-20-24-27-30-32 mm
- 1/2", 1/4"
- 5/16" bit holder
- 18 x
- 17 x
- 3 way adapter
- 4 x
- 1/4"
- L 1/4"

No. specification

17236



SOCKET SET



- CrV** **S2**
- 1/4"**
- 1/2"**
- 3/8"**
- 72T**
- 171x**
- ERGO HANDLE**



- 1/2", 1/4", 3/8"
- 1/4" · 4-5-6-7-8-9-10mm
- 3/8" · 10-11-12-13-14-15mm
- 1/2" · 16-17-18-19-22mm
- 1/4" · 4-4,5-5-5,5-6-7-8-9-10-11-12-13-14mm
- 3/8" · 10-11-12-13-14-15-16-17-18-19mm
- 1/2" · 10-11-12-13-14-15-16-17-18-19-20-21-22-24-27-30-32mm
- 1/4" · E4-E5-E6-E7-E8
- 3/8" · E10-E11-E12-E14-E16-E18
- 1/2" · E20-E24
- 1/2" · 24x
- 1/4" · 20x
- 1/4" · 30x
- 1/4" · 50 mm, 100 mm
- 1/2" · 125 mm, 250 mm
- 3/8" · 150 mm
- 1/2" · 16-21mm
- 3/8" · 18mm
- 1/2", 1/4", 3/8" bit holder
- 1/2", 1/4", 3/8"
- 1/4" · 150mm
- 1/4" · 115mm
- Inbus 7X

No. specification

17237



FESTA®



RATCHET FESTA

- Ratchet is made from the best quality ChromVanadium steel
- Ratchet with 72 teeth for most precise work
- Quality ergonomic, two-component handle made of softened TPE rubber
- SYSTEM QUICK RELEASE for quick and easy changing of socket heads

RATCHET

FESTA®



No.	specification	length	
17297	1/4"	155 mm	6
17298	3/8"	210 mm	5
17299	1/2"	255 mm	4

RATCHET

FESTA®



No.	specification	length	
17240	1/4"	155 mm	10
17241	3/8"	200 mm	10
17242	1/2"	250 mm	5

RATCHET

FESTA®



No.	specification	length	
17294	1/4"	155 mm	6
17295	3/8"	205 mm	10
17296	1/2"	255 mm	4

REVERSIBLE RATCHET 1/4"

FESTA®



No.	specification	
17292	1/4"	1

RATCHET



HOBBY



No.	specification	
17243	1/4"	25
17244	1/2"	25

ADAPTER FOR SOCKETS

FESTA®

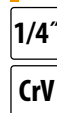

No.	specification	
18603	1/4" 150 mm	10

UNIVERSAL SOCKET HEAD

CrV



1/2"



1/4"

1/2"

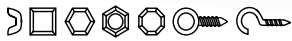

No.	specification
17811	for screws 11 - 32mm • 83mm x ø43mm

5

UNIVERSAL SOCKET HEAD

CrV



3/8"



1/4"

3/8"

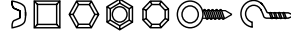

No.	specification
17810	for screws 7 - 19mm • 52mm x ø26mm

1

SOCKET HEAD 1/4"

FESTA

CrV



1/4"



No.	specification	
17820	4 mm • 25 mm	10
17821	4,5 mm • 25 mm	10
17822	5 mm • 25 mm	10
17823	5,5 mm • 25 mm	10
17824	6 mm • 25 mm	10
17825	7 mm • 25 mm	10
17826	8 mm • 25 mm	10

No.	specification	
17827	9 mm • 25 mm	10
17828	10 mm • 25 mm	10
17829	11 mm • 25 mm	10
17830	12 mm • 25 mm	10
17831	13 mm • 25 mm	10
17832	14 mm • 25 mm	10

SOCKET HEAD DEEP LONG 1/4"

FESTA

CrV



1/4"



No.	specification	
17860	4 mm • 70 mm	10
17861	5 mm • 70 mm	10
17862	6 mm • 70 mm	10
17863	7 mm • 70 mm	10
17864	8 mm • 70 mm	10
17865	9 mm • 70 mm	10

No.	specification	
17866	10 mm • 70 mm	10
17867	11 mm • 70 mm	10
17868	12 mm • 70 mm	10
17869	13 mm • 70 mm	10
17870	14 mm • 70 mm	10

SOCKET HEAD 1/2"

FESTA

CrV



1/2"



No.	specification	
17308	8 mm • 38 mm	10
17309	9 mm • 38 mm	10
17310	10 mm • 38 mm	10
17311	11 mm • 38 mm	10
17312	12 mm • 38 mm	10
17313	13 mm • 38 mm	10
17314	14 mm • 38 mm	10
17315	15 mm • 38 mm	10
17316	16 mm • 38 mm	10
17317	17 mm • 38 mm	10
17318	18 mm • 38 mm	10

No.	specification	
17319	19 mm • 38 mm	10
17320	20 mm • 38 mm	10
17321	21 mm • 38 mm	10
17322	22 mm • 38 mm	10
17324	24 mm • 38 mm	10
17327	27 mm • 42 mm	20
17330	30 mm • 42 mm	25
17332	32 mm • 42 mm	20
17333	34 mm • 42 mm	20
17334	36 mm • 42 mm	20

SOCKET HEAD DEEP (LONG) 1/2"

FESTA

CrV



1/2"



No.	specification	
17871	10 mm • 70 mm	10
17872	11 mm • 70 mm	10
17873	12 mm • 70 mm	10
17874	13 mm • 70 mm	10
17875	14 mm • 70 mm	10
17876	15 mm • 70 mm	10
17877	16 mm • 70 mm	10
17878	17 mm • 70 mm	10
17879	18 mm • 70 mm	10
17880	19 mm • 70 mm	10
17881	20 mm • 70 mm	10

No.	specification	
17882	21 mm • 70 mm	10
17883	22 mm • 70 mm	10
17884	23 mm • 70 mm	10
17885	24 mm • 70 mm	10
17886	25 mm • 70 mm	10
17887	26 mm • 70 mm	10
17888	27 mm • 70 mm	10
17889	28 mm • 70 mm	10
17890	30 mm • 70 mm	10
17891	32 mm • 70 mm	10
17892	34 mm • 70 mm	10



SOCKET HEAD 3/4"



No.	specification		No.	specification	
17835	17 mm · 48 mm	10	17846	33 mm · 55 mm	10
17836	18 mm · 48 mm	10	17847	36 mm · 60 mm	10
17837	19 mm · 48 mm	10	17848	38 mm · 60 mm	10
17838	21 mm · 48 mm	10	17849	41 mm · 65 mm	10
17839	22 mm · 48 mm	10	17850	46 mm · 65 mm	10
17840	24 mm · 48 mm	10	17851	50 mm · 70 mm	10
17841	26 mm · 48 mm	10	17852	55 mm · 75 mm	10
17842	27 mm · 52 mm	10	17853	60 mm · 78 mm	10
17843	28 mm · 52 mm	10	17854	65 mm · 82 mm	10
17844	30 mm · 52 mm	10	17855	70 mm · 82 mm	10
17845	32 mm · 52 mm	10	17856	75 mm · 88 mm	10

SOCKET HEAD - MULTIDRIVE 1/4"



No.	specification		No.	specification	
17895	4 mm · 25 mm	10	17902	9 mm · 25 mm	10
17896	4,5 mm · 25 mm	10	17904	11 mm · 25 mm	10
17897	5 mm · 25 mm	10	17905	12 mm · 25 mm	10
17898	5,5 mm · 25 mm	10	17907	14 mm · 25 mm	10
17900	7 mm · 25 mm	10			

SOCKET HEAD - MULTIDRIVE 1/2"



No.	specification		No.	specification	
17910	8 mm · 38 mm	10	17922	21 mm · 38 mm	10
17912	10 mm · 38 mm	10	17924	24 mm · 38 mm	10
17913	11 mm · 38 mm	10	17925	27 mm · 38 mm	10
17914	12 mm · 38 mm	10	17926	30 mm · 38 mm	10
17916	14 mm · 38 mm	10	17927	32 mm · 38 mm	10
17921	19 mm · 38 mm	10			

TORX SOCKET 1/4"



No.	specification		No.	specification	
17930	E4	10	17933	E7	10
17931	E5	10	17934	E8	10
17932	E6	10	17935	E10	10

TORX SOCKET 1/2"



No.	specification	
17943	E22	10
17944	E24	10

SLOTTED SOCKET BIT 1/4"



CrV S2



1/4"



No.	specification	
18920	4 mm	10
18921	5,5 mm	10
18922	7 mm	10

PHILIPS SOCKET BIT 1/4"



CrV S2



1/4"



No.	specification	
18925	PH 1	10
18926	PH 2	10
18927	PH 3	10

POZIDRIVE SOCKET BIT 1/4"



CrV S2



1/4"



No.	specification	
18928	PZ 0	10
18929	PZ 1	10
18930	PZ 2	10
18931	PZ 3	10

XZN SOCKET BIT 1/2"



CrV S2



1/2"



No.	specification		No.	specification	
18967	M 8	10	18970	M 14	10
18968	M 10	10	18971	M 16	10
18969	M 12	10	18972	M 18	10

HEX SOCKET BIT 1/4"



CrV S2



1/4"



No.	specification		No.	specification	
18934	3 mm	10	18937	6 mm	10
18935	4 mm	10	18939	8 mm	10

HEX SOCKET BIT 1/2"



CrV S2



1/2"



No.	specification	
18944	12 mm	10
18945	14 mm	10

TORX SOCKET BIT 1/4"



CrV S2



1/4"



No.	specification	
18948	T 5	10
18950	T 8	10
18951	T 10	10

TORX SOCKET BIT 1/2"



CrV S2



1/2"



No.	specification		No.	specification	
18954	T 10	10	18960	T 40	10
18955	T 15	10	18961	T 45	10
18956	T 20	10	18963	T 55	10
18957	T 25	10			

ADAPTER



CrV



No.	specification	
17410	A - 1/4" B - 3/8"	10
17411	A - 3/8" B - 1/4"	10
17412	A - 3/8" B - 1/2"	10
17413	A - 1/2" B - 3/8"	10

No.	specification	
17414	A - 1/2" B - 3/4"	10
17415	A - 3/4" B - 1/2"	10
17416	A - 1/4" B - 1/2"	10

UNIVERSAL JOIN



CrV



No.	specification	
17405	1/4" · 39 mm	10
17406	1/2" · 71 mm	10
17407	3/4" · 105 mm	10

T-M HEAD FOR SLIDING BAR



CrV



No.	specification	
17420	1/4"	1
17421	1/2"	1
17422	3/4"	1

SLIDING „T“ BAR



CrV



No.	specification	
17382	1/4" · 115 mm	1
17383	3/8" · 190 mm	1
17384	1/2" · 250 mm	1
17385	3/4" · 460 mm	1
17386	1' · 640 mm	1

EXTENTION WRENCH WITH SOCKET



CrV



No.	specification	
17401	1/4" · 250 mm	1
17402	1/2" · 400 mm	1



SWIVEL HANDLE



CrV



No.	specification	
17380	1/2" · 350 mm	1
17381	3/4" · 500 mm	1

L HANDLE



CrV

1/2"



No.	specification	
17427	1/2" · 60 x 320 mm	1

EXTENSION BAR



CrV



No.	specification		No.	specification	
17390	1/4" · 50 mm	1	17395	1/2" · 250 mm	1
17391	1/4" · 100 mm	1	17396	3/4" · 100 mm	1
17392	1/4" · 150 mm	1	17397	3/4" · 200 mm	1
17393	1/2" · 75 mm	1	17398	3/4" · 400 mm	1
17394	1/2" · 125 mm	1			

FLEXIBLE EXTENSION BAR



CrV

1/4"



No.	specification	
17400	1/4" · 150 mm	1

ADAPTER RATCHET 1/4" - BIT



CrV



1/4" ↔ 1/4"

No.	specification	
18619		5

SET OF ADAPTERS

CrV



1/4"

3x



No.	specification	
18604	1/4", 3/8", 1/2"	10

UNIVERSAL SPUD WRENCH



CrV

1/2"

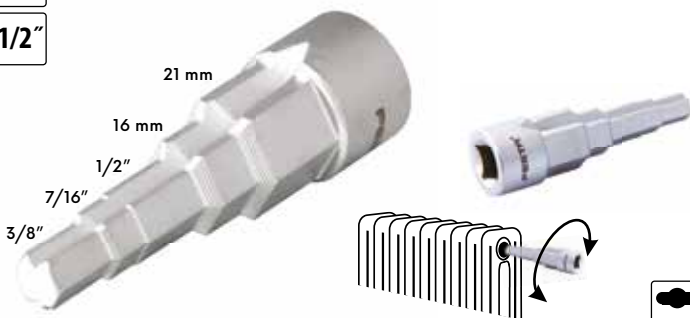

No.	specification	
17455	for ratchet 1/2"	10

UNIVERSAL KEY FOR SWITCH CABINET

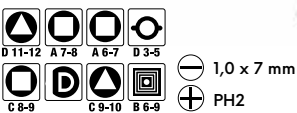

No.	specification	
17456		50

FESTA®

- Forged keys made of CrV grade steel
- Made according to DIN standards
- Chrome coating



DOUBLEOPEN SPANNER



CrV

DIN 3110



No.	specification		No.	specification	
17550	6 x 7 mm	10	17592	19 x 22 mm	10
17551	8 x 9 mm	10	17593	19 x 24 mm	10
17552	8 x 10 mm	10	17561	20 x 22 mm	10
17553	10 x 11 mm	10	17569	21 x 23 mm	10
17590	10 x 13 mm	10	17548	22 x 24 mm	10
17554	12 x 13 mm	10	17562	24 x 27 mm	10
17555	14 x 15 mm	10	17549	24 x 30 mm	10
17556	13 x 16 mm	10	17563	30 x 32 mm	10
17557	13 x 17 mm	10	17564	30 x 34 mm	10
17591	14 x 17 mm	10	17565	32 x 36 mm	10
17558	16 x 17 mm	10	17566	36 x 41 mm	10
17559	17 x 19 mm	10	17567	46 x 50 mm	10
17560	18 x 19 mm	10	17568	55 x 60 mm	3

COMBINATION SPANNER



CrV

DIN 3113



No.	specification		No.	specification	
17487	6 mm	10	17489	21 mm	10
17570	7 mm	10	17583	22 mm	10
17571	8 mm	10	17490	23 mm	10
17572	9 mm	10	17584	24 mm	10
17573	10 mm	10	17491	25 mm	10
17574	11 mm	10	17492	26 mm	10
17575	12 mm	10	17585	27 mm	10
17576	13 mm	10	17493	28 mm	10
17577	14 mm	10	17494	29 mm	10
17578	15 mm	10	17586	30 mm	10
17579	16 mm	10	17587	32 mm	10
17580	17 mm	10	17495	33 mm	10
17581	18 mm	10	17496	34 mm	10
17582	19 mm	10	17589	36 mm	10
17488	20 mm	10			

RATCHET SWIVEL SPANNER



CrV

72T



No.	specification		No.	specification	
17628	8 mm	10	17625	17 mm	10
17622	10 mm	10	17631	18 mm	10
17623	13 mm	10	17626	19 mm	10
17624	14 mm	10	17632	21 mm	5
17629	15 mm	10	17633	22 mm	5
17630	16 mm	5			

RATCHET SPANNER



CrV

72T



No.	specification		No.	specification	
17660	6 mm	10	17669	16 mm	10
17676	7 mm	10	17670	17 mm	10
17661	8 mm	10	17671	18 mm	10
17662	9 mm	10	17672	19 mm	10
17663	10 mm	10	17674	21 mm	5
17664	11 mm	10	17675	22 mm	5
17665	12 mm	10	17677	24 mm	5
17666	13 mm	10	17678	27 mm	5
17667	14 mm	10	17679	30 mm	5
17668	15 mm	10	17683	32 mm	5

RING SPANNER



CrV

DIN 838



No.	specification	
17605	6 x 7 mm	10
17606	8 x 9 mm	10
17607	8 x 10 mm	10
17608	10 x 11 mm	10
17609	12 x 13 mm	10
17611	13 x 16 mm	10
17612	13 x 17 mm	10

No.	specification	
17610	14 x 15 mm	10
17613	16 x 17 mm	10
17614	18 x 19 mm	10
17615	20 x 22 mm	10
17616	24 x 27 mm	10
17617	30 x 32 mm	10

DOUBLEOPEN SPANNER DIN 895



DIN 895



No.	specification	
17460	6 x 7 mm	10
17461	8 x 9 mm	10
17462	8 x 10 mm	10
17463	10 x 11 mm	10
17481	10 x 13 mm	10
17464	12 x 13 mm	10
17465	14 x 15 mm	10
17466	13 x 16 mm	10
17467	13 x 17 mm	10
17482	14 x 17 mm	10
17468	16 x 17 mm	10

No.	specification	
17469	17 x 19 mm	10
17470	18 x 19 mm	10
17483	19 x 22 mm	10
17484	19 x 24 mm	10
17471	20 x 22 mm	10
17472	24 x 27 mm	10
17486	21 x 23 mm	10
17480	28 x 30 mm	10
17473	30 x 32 mm	10
17485	36 x 41 mm	10

DOUBLEOPEN SPANNER



CrV

DIN 3110



No.	specification	
17762	13 x 16 mm	10
17761	14 x 15 mm	10

No.	specification	
17766	18 x 19 mm	10
17769	20 x 22 mm	10

COMBINATION SPANNER



CrV

DIN 3113



No.	specifikace	
17788	14 mm	10
17789	15 mm	10

No.	specifikace	
17795	21 mm	10
17806	33 mm	10

SOCKET WRENCH

Cr-Mo



12-13-14-15 mm

16-17-18-19 mm



No.	specification
17685	12-13-14-15-16-17-18-19 mm



1

ADJUSTABLE WRENCH



CrV



No.	rozsah range	length	
17197	0 - 29 mm	200 mm	1
17198	0 - 33 mm	250 mm	1
17199	0 - 38 mm	300 mm	1

ADJUSTABLE WRENCH



No.	rozsah range	length	
17200	0 - 24 mm	200 mm	6
17201	0 - 30 mm	250 mm	6
17202	0 - 34 mm	300 mm	6

OPEN - END WRENCH SET

CrV

FESTA

DIN 3110



No.	specification	
17506	6 pcs · 6 x 7, 8 x 9, 10 x 11, 12 x 13, 14 x 15, 16 x 17	1
17508	8 pcs · 6 x 7, 8 x 9, 10 x 11, 12 x 13, 14 x 15, 16 x 17, 18 x 19, 20 x 22	1

COMBINATION SPANNER SET

CrV

FESTA

DIN 3113



No.	specification	
17526	6 pcs · 10 x 10, 11 x 11, 13 x 13, 14 x 14, 16 x 16, 17 x 17	1
17528	8 pcs · 8 x 8, 10 x 10, 11 x 11, 13 x 13, 14 x 14, 16 x 16, 17 x 17, 19 x 19	1

RINGSPANNER SET

CrV

FESTA

DIN 838

8x



No.	specification	
17539	6 x 7, 8 x 9, 10 x 11, 12 x 13, 14 x 15, 16 x 17, 18 x 19, 20 x 22	1

COMBINATION SPANNER SETS

CrV

FESTA

DIN 3113



No.	specification	
17532	12 pcs · 8 x 8, 9 x 9, 10 x 10, 11 x 11, 13 x 13, 14 x 14, 16 x 16, 17 x 17, 18 x 18, 19 x 19, 21 x 21, 22 x 22	10
17533	18 pcs · 6 x 6, 7 x 7, 8 x 8, 9 x 9, 10 x 10, 11 x 11, 12 x 12, 13 x 13, 14 x 14, 15 x 15, 16 x 16, 17 x 17, 18 x 18, 19 x 19, 20 x 20, 21 x 21, 22 x 22, 24 x 24	1
17534	25 pcs · 6 x 6, 7 x 7, 8 x 8, 9 x 9, 10 x 10, 11 x 11, 12 x 12, 13 x 13, 14 x 14, 15 x 15, 16 x 16, 17 x 17, 18 x 18, 19 x 19, 20 x 20, 21 x 21, 22 x 22, 23 x 23, 24 x 24, 25 x 25, 26 x 26, 27 x 27, 28 x 28, 30 x 30, 32 x 32	4

OPEN - END WRENCH SETS

CrV

FESTA

DIN 3110

12x



No.	specification	
17512	6 x 7, 8 x 9, 10 x 11, 12 x 13, 14 x 15, 16 x 17, 18 x 19, 20 x 22, 21 x 23, 24 x 27, 25 x 28, 30 x 32	1

OPEN END SPANNER SETS DIN 895

DIN 895

FESTA



No.	specification	
17475	8 pcs · 6 x 7, 8 x 9, 10 x 11, 12 x 13, 14 x 15, 16 x 17, 18 x 19, 20 x 22	5
17476	12 pcs · 6 x 7, 8 x 9, 10 x 11, 12 x 13, 14 x 15, 16 x 17, 18 x 19, 20 x 22, 21 x 23, 24 x 27, 28 x 30, 30 x 32	3

RATCHET SPANNER SET



CrV



7x



No.	specification	
17620	8, 10, 12, 13, 14, 17, 19	5

RATCHET SWIVEL SPANNER SET



NEW

CrV



7x



No.	specification	
17621	10, 12, 13, 14, 15, 17, 19	5

TUBULAR SPANNER SET



CrV

7x



No.	specification	
17501	6 x 7, 8 x 9, 10 x 11, 12 x 13, 14 x 15, 16 x 17, 18 x 19	20
17640	tommy bar · 135 mm	50

TUBULAR SPANNER



CrV



No.	specification		No.	specification	
17650	6 x 7 mm	10	17655	16 x 17 mm	10
17651	8 x 9 mm	10	17645	16 x 18 mm	10
17642	8 x 10 mm	10	17653	16 x 21 mm	10
17652	10 x 11 mm	10	17656	18 x 19 mm	10
17643	12 x 13 mm	10	17657	19 x 22 mm	10
17654	14 x 15 mm	10	17659	22 x 24 mm	10
17644	14 x 17 mm	10	17658	24 x 27 mm	10

HOOK SPANNER



CrV



No.	specification	
17680	19 - 51 mm 165 mm	5
17681	32 - 76 mm 216 mm	5
17682	51 - 121 mm 267 mm	5

QUICK-RELEASE NUT FOR ANGLE GRINDERS

NEW

M14



No.	specification	
20969		1

KEY FOR ANGLE GRINDER ADJUSTABLE



No.	specification	
20967	200 mm	15

WRENCH FOR ANGLE GRINDER

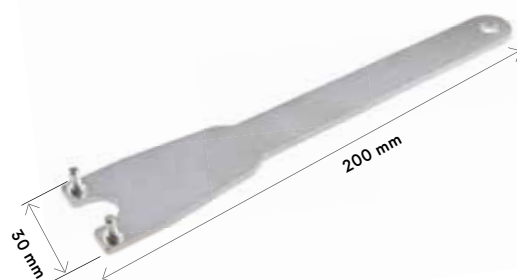

No.	specification	
20968	200 mm	1

TORQUE WRENCH



No.	specification	
17203	1/4" 5 - 25 Nm	1
17204	1/2" 19 - 110 Nm	1
17205	1/2" 42 - 210 Nm	1
17206	3/4" 140 - 700 Nm	1

SCAFFOLDING RATCHET



No.	specification	
17451	18 mm	1
17450	19 mm	1

WHEEL SPANNER, CROSS



No.	specification	
17600	17, 19, 22 mm, 13/16"	20

WHEEL SPANNER, CROSS



No.	specification	
17601	17, 19, 21 mm	20

WHEEL SPANNER, CROSS, FOLDING



No.	specification	
17602	17, 19, 21, 23 mm	5

TELESCOPIC WHEEL SPANNER



No.	specification	
17603	17 x 19 mm, 21 x 23 mm	20

SOCKET WRENCH WITH JOINT



No.	specification	
17261	16 mm	1
17262	21 mm	1

MAGNETIC TOOL HOLDER



No. specification

70098

12

MAGNETIC TELESCOPE PICK UPPER - LED LIGHT



NEW

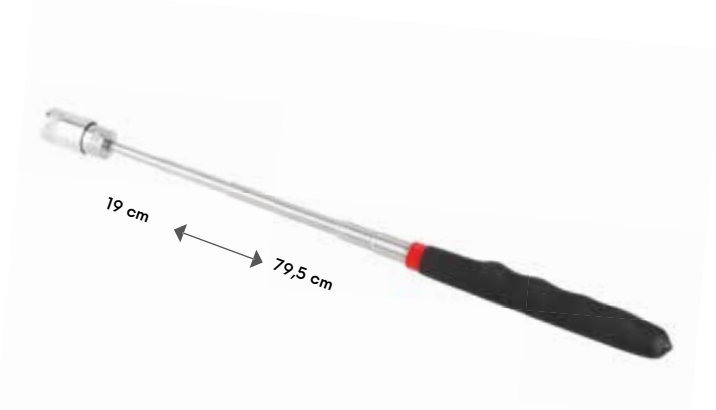

No. specification

13294

6

INSPECTION MIRROR TELESCOPE

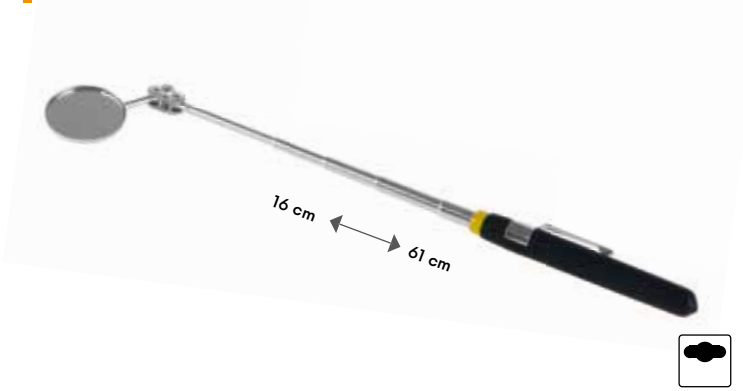

No. specification

13290

20

MAGNETIC TELESCOPE PICK UPPER

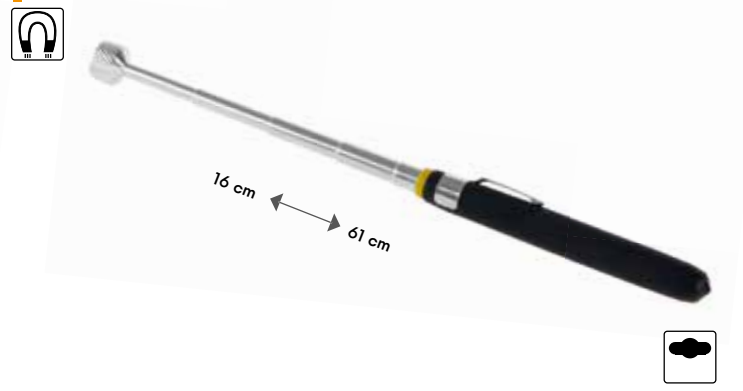

No. specification

13293

20

FESTA[®]

- Shaft made of quality S2 steel
- Magnetic ending
- Ergonomic two-component with softened TPE rubber



SCREWDRIVER

FESTA[®]



No.	specification	
18113	3 x 75 mm	12
18114	4 x 100 mm	12
18115	5,5 x 125 mm	12
18116	6,5 x 150 mm	12
18118	8 x 175 mm	6
18120	10 x 200 mm	6

SCREWDRIVER SHORT

FESTA[®]



No.	specification	
18124	5 x 38 mm	12
18125	6 x 38 mm	12

PHILIPS SCREWDRIVER

FESTA[®]



No.	specification	
18210	0 x 75 mm	12
18211	1 x 75 mm	12
18212	2 x 100 mm	12

PHILIPS SCREWDRIVER SHORT

FESTA[®]

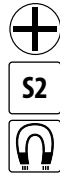

No.	specification	
18215	1 x 38 mm	12
18216	2 x 38 mm	12

POZIDRIVE SCREWDRIVER

FESTA[®]



No.	specification	
18310	0 x 75 mm	12
18311	1 x 100 mm	12
18312	2 x 100 mm	12
18313	3 x 150 mm	16

POZIDRIVE SCREWDRIVER SHORT

FESTA[®]

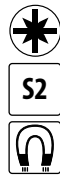

No.	specification	
18321	1 x 38 mm	12
18322	2 x 38 mm	12

TORX SCREWDRIVER

FESTA



S2



No.	specification	
18350	T6	12
18351	T7	12
18352	T8	12
18353	T9	12
18354	T10	12
18355	T15	12

No.	specification	
18356	T20	12
18357	T25	12
18358	T27	12
18359	T30	12
18360	T40	12



SOCKET SCREWDRIVER

FESTA



CrV



No.	specification	
18455	6 mm	12
18456	7 mm	12
18460	13 mm	12



IMPACT SCREWDRIVER

FESTA



CrV



No.	specification	
18062	5,5 x 100 mm	12
18063	7 x 125 mm	6
18064	8 x 150 mm	8

No.	specification	
18065	10 x 175 mm	6
18066	10 x 200 mm	6
18067	10 x 250 mm	6



VDE SCREWDRIVER

FESTA



1000 V IEC/EN60900

No.	specification	
18088	3 x 75 mm S2	12
18089	4 x 100 mm CrV	12
18090	5,5 x 125 mm CrV	12
18091	6,5 x 150 mm CrV	12
18092	8 x 175 mm CrV	12



PHILIPS IMPACT SCREWDRIVER

FESTA



CrV



No.	specification	
18070	PH 1 x 80 mm	16
18071	PH 2 x 100 mm	12
18072	PH 3 x 150 mm	6



PHILIPS VDE SCREWDRIVER

FESTA



1000 V IEC/EN60900

No.	specification	
18080	PH 0 x 60 mm S2	12
18081	PH 1 x 80 mm CrV	12
18082	PH 2 x 100 mm CrV	12
18083	PH 3 x 150 mm CrV	12



POZIDRIVE IMPACT SCREWDRIVER

FESTA



CrV



No.	specification	
18075	PZ 1 x 80 mm	12
18076	PZ 2 x 100 mm	12
18077	PZ 3 x 150 mm	6



POZIDRIVE VDE SCREWDRIVER

FESTA



1000 V IEC/EN60900

No.	specification	
18084	PZ 0 x 60 mm S2	12
18085	PZ 1 x 80 mm CrV	12
18086	PZ 2 x 100 mm CrV	12
18087	PZ 3 x 150 mm CrV	12



SCREWDRIVER SET



- S2
-
- 7x



- S 3x75 · 5x100 · 6x175mm
- PH 0 · 1 · 2 · 3



No. specification
18402

6

SCREWDRIVER SET



- S2
-
- 6x



- S 3x75 · 5x100 · 6x150mm
- PH 0 · 1 · 2



No. specification
18403

6

SCREWDRIVER SET



- S2
-
- 6x



- S 3x60 · 6x100 · 6x125mm
- PZ 0 · 1 · 2



No. specification
18404

6

SCREWDRIVER SET TORX



- S2
-
- 5x



- T 10 · 15 · 20 · 25 · 30



No. specification
18340

6

SCREWDRIVER SET



- S2
-
- 27x



- S 3 x 75 · 4x100 · 5,5x125 · 6,5 x 150mm
- PH 1 x 100 · 2 x 100mm
- adapter 1/4"

- bits:
- S 4 · 5 · 6 · 7
 - PH 1 · 2 · 3
 - PZ 1 · 2 · 3
 - T 10 · 15 · 20 · 25 · 30
 - H 2 · 3 · 4 · 5 · 6



No. specification
18422

27 pcs

6

SCREWDRIVER SET



- CrV
-
- 18x



- S 6x38 · 5x75 · 6x100 · 8x150mm
2,5x50 · S 3x50mm

- PH 2x38 · 1x75 · 2x100 · 3x150mm
0x50 · 00x50mm

- T 5x50 · 6x50 · 7x50 · 8x50 · 9x50 · 10x50mm



No. specification
18424

18424

6

SCREWDRIVER SET



CrV

6x



⊖ S 5 · 6 · 8 mm

⊕ PH 1 · 2 · 3

No. specification

18423



10

ELECTRO SCREWDRIVER SET



6x



⚠ 1000 V ⚠
IEC/EN60900

⊖ S 4x100 · 5,5x125 mm · voltage detector 0 - 250 V

⊕ PH 0x60 · 1x80 · 2x100 mm

No. specification

18413



6

SCREWDRIVER + 6 BITS



CrV

6x



⊖ S 7 x 35 · 8 x 35 · 8 x 70 mm

⊕ PH 2 x 35 · 3 x 35 · 3 x 70 mm

No. specification

18411



1

ELECTRO SCREWDRIVER SET



7x



⚠ 1000 V ⚠
IEC/EN60900:2004

⊖ S 4x100 · 5.5x125 · 6.5x150 mm · voltage detector 0 - 250 V

⊕ PH 0x75 · 1x100 · 2x100 mm

No. specification

18410



40

BOTTLE OPENER



No. specification

18437



5

VOLTAGE DETECTOR

DIN VDE 0680
73/23 EEC



No. specification
18426 0 - 250 V



1

SCREWDRIVER



No.	specification	
18101	3,5 x 75 mm	10
18102	4 x 100 mm	10
18103	5,5 x 100 mm	10
18104	5,5 x 125 mm	10
18105	6,5 x 100 mm	10
18106	6,5 x 125 mm	10
18107	8 x 160 mm	10
18108	10 x 160 mm	10



SCREWDRIVER AND BIT SET



- S 3x75 · 4x75 · 6x100 · 8x150 mm
- PH 1x75 · 2x100 mm
- adapter 1/4"
- bits:
 - S 4 · 5 · 6 · 7 mm
 - PH 1 · 2 · 3
 - PZ 1 · 2 · 3
 - T 10 · 15 · 20
 - adapter

No.	specification	
18418		10

PHILIPS SCREWDRIVER



No.	specification	
18201	0 x 75 mm	10
18202	1 x 75 mm	10
18203	2 x 100 mm	10
18204	3 x 150 mm	10



PHILIPS SCREWDRIVER



- S 3x60 · 4x75 · 6x100 · 6x125 mm
- PH 0x60 · 1x75 · 2x100 mm

No.	specification	
18400		10

POZIDRIVE SCREWDRIVER



No.	specification	
18301	0 x 75 mm	10
18302	1 x 75 mm	10
18303	2 x 100 mm	10
18304	3 x 150 mm	10



PHILIPS SCREWDRIVER



- S 3x60 · 6x100 · 6x125 mm
- PH 1x75 · 2x100 mm

No.	specification	
18401		50



T SCREWDRIVER FOR BITS WITH RATCHET

FESTRA

- 1/4"
-
-



No. specification
18608



SCREWDRIVER FOR BITS

FESTRA

- 1/4"
-



No. specification
18110



SCREWDRIVER FOR BITS WITH RATCHET

FESTRA

- 1/4"
-
-



No. specification
18433



SCREWDRIVER FOR BITS + 7 BITS

FESTRA

- 1/4"
-
-



- S 5 · 6 mm
 - PH 1 · 2 · 3
 - T 15 · 20
- No. specification
18425



FLEXI SCREWDRIVER FOR HOSE CLAMPS

FESTRA

- 1/4"



No. specification
18451



FLEXI SCREWDRIVER FOR HOSE CLAMPS

FESTRA

-



No. specification
18450 7 mm

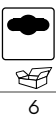

ANGLE ADAPTER FOR BITS 90°

- 1/4"
-



No. specification
18910



BIT RATCHET

- 1/4"
-
-



No. specification
18435 93 mm



SCREWDRIVER RATCHET + BITS **FESTA**

1/4" CrV 45x

- 1/4" → 1/4"
- S 3 · 4 · 5 · 6 · 7 · 5 L
- PH 1 · 2 · 3 · 1 L · 2 L
- PZ 1 · 2 · 3 · 1 L · 2 L
- H 2 · 2.5 · 3 · 4 · 5 · 6
- T 10 · 15 · 20 · 25 · 27 · 30
- SQ 0 · 1 · 2 · 3
- 1/4" 5 · 6 · 7 · 8 · 9 · 10 · 11 · 12 · 13 mm



No. specification
18419 6

SCREWDRIVER + 20 BITS **FESTA**

1/4"

20x

- S 3 · 4 · 5 · 6 · 8 mm
- PH 0 · 1 · 2 · 3
- adapter + 5 · 6 · 7 · 8 · 9 · 10 · 11 · 12 · 13 mm



No. specification
18420 5

PRECISION SCREWDRIVER SET **FESTA**

CrV



6x

- S 1,5x50 · 2x50 · 2,5x50 mm
- PH 000x50 · 00x50 · 0x50 mm



No. specification
18416 6

PRECISION SCREWDRIVER SET TORX **FESTA**

CrV



7x

- T 4 · 5 · 6 · 7 · 8 · 9 · 10x50 mm



No. specification
18417 6

SCREWDRIVER WITH PRECISION BITS **FESTA**

CrV

50x



- S 1.5 · 2 · 2.5 · 3 · 3.5 mm
- PH 000 · 00 · 0 · 1
- PZ 0 · 1
- T 5 · 6 · 7 · 8 · 9 · 10 · 15 · 20
- H 0.9 · 1.3 · 2.0 · 2.5 · 3.0 · 4.0



No. specification
18431 6

PRECISION ELECTRO SCREWDRIVER SET **FESTA**

6x

- S 2,4 · 3,0 mm
- PH 0 · 1
- T 6 · 8



No. specification
18415 10

PRECIZION SCREWDRIVER SET



6x HOBBY

- S 1,4 · 2,0 · 2,4 · 3,0 mm
- PH 0 · 1



No. specification
18408 10

PRECIZION SCREWDRIVER SET



11x HOBBY

- S 1,0 · 1,2 · 1,4 · 1,8 · 2,4 · 3,0 mm
- PH 00 · 0 · 1



No. specification
18409 48

Stahlberg

bits – professional screwing attachments of high alloyed material S2



STAHLBERG producer

A trademark of world producer of screwing attachments with long-lasting experience in a field and with customers all over the world. During the production the latest technologies, up till now the best developed materials and surfacings are used.



Forged attachments

cross-headed and flat bits are made by special technology of precise forging. It enables achieving of high accuracy in shape, together with increasing in hardness in comparison with the bits by 20 %.

TiN layer

double applied on the surface of screwing spikes, it maximally increases the hardness, wipe resistance and frictional qualities prevent slipping out of the meshing.



Diamond grains

on the surface of the spike they really "bite" into the head of the wood screw or screw and enable to transfer maximum tightening torque. They are the best guarantee for staying in the meshing.



Nonskid grooves

on the working surfaces of the spikes made by forging are another very effective protection against the slipping out of the meshing.



BIT PH DIAMANT



+

DIN 3128

S2 TiN



No.	specification	MOQ
18770	PH1 x 25 mm	5
18771	PH2 x 25 mm	5
18772	PH3 x 25 mm	5

MOQ 5

BIT PZ DIAMANT



✳

DIN 3128

S2 TiN



No.	specification	MOQ
18775	PZ1 x 25 mm	5
18776	PZ2 x 25 mm	5
18777	PZ3 x 25 mm	5

MOQ 5

BIT PH



+

S2



No.	specification	MOQ
18630	PH0 x 25 mm	5
18631	PH1 x 25 mm	5
18632	PH2 x 25 mm	5
18633	PH3 x 25 mm	5
18634	PH4 x 25 mm	5

MOQ 5

BIT PZ



✳

S2



No.	specification	MOQ
18635	PZ0 x 25 mm	5
18636	PZ1 x 25 mm	5
18637	PZ2 x 25 mm	5
18638	PZ3 x 25 mm	5
18639	PZ4 x 25 mm	5

MOQ 5

BIT PH



+

S2



No.	specification	MOQ
18685	PH2 x 25 mm	5

MOQ 5

BIT PZ



✳

S2



No.	specification	MOQ
18680	PZ2 x 25 mm	5

MOQ 5

BIT PH



+

S2



No.	specification	MOQ
18640	PH1 x 70 mm	10
18641	PH2 x 70 mm	10

MOQ 10

BIT PZ



✳

S2



No.	specification	MOQ
18645	PZ1 x 70 mm	10
18646	PZ2 x 70 mm	10

MOQ 10

BIT PH



+

S2 TiN



No.	specification	MOQ
18760	PH0 x 25 mm	5
18761	PH1 x 25 mm	5
18762	PH2 x 25 mm	5
18763	PH3 x 25 mm	5
18764	PH4 x 25 mm	1

MOQ 5

BIT PZ



✳

S2 TiN



No.	specification	MOQ
18765	PZ0 x 25 mm	5
18766	PZ1 x 25 mm	5
18767	PZ2 x 25 mm	5
18768	PZ3 x 25 mm	5
18769	PZ4 x 25 mm	5

MOQ 5

BIT S



—

S2



No.	specification	MOQ
18620	S 3 x 25 mm	5
18621	S 4 x 25 mm	5
18623	S 5 x 25 mm	5
18625	S 6 x 25 mm	5
18627	S 7 x 25 mm	5
18628	S 8 x 25 mm	5

MOQ 5

BIT S



—

S2 TiN



No.	specification	MOQ
18750	S 3 x 25 mm	5
18751	S 4 x 25 mm	5
18753	S 5 x 25 mm	5
18755	S 6 x 25 mm	5

MOQ 5

BIT H



S2



No.	specification	
18800	H 1,5 x 25 mm	5
18801	H 2,0 x 25 mm	5
18802	H 2,5 x 25 mm	5
18803	H 3,0 x 25 mm	5
18804	H 4,0 x 25 mm	5
18805	H 5,0 x 25 mm	5
18806	H 5,5 x 25 mm	5
18807	H 6,0 x 25 mm	5

BIT HTA



S2



No.	specification	
18810	HTα 1,5 x 25 mm	5
18811	HTα 2,0 x 25 mm	5
18812	HTα 2,5 x 25 mm	5
18813	HTα 3,0 x 25 mm	5
18814	HTα 4,0 x 25 mm	5
18815	HTα 5,0 x 25 mm	5
18816	HTα 5,5 x 25 mm	5
18817	HTα 6,0 x 25 mm	5

BIT T



S2



No.	specification	
18820	T5 x 25 mm	5
18821	T6 x 25 mm	5
18822	T7 x 25 mm	5
18823	T8 x 25 mm	5
18824	T9 x 25 mm	5
18825	T10 x 25 mm	5
18826	T15 x 25 mm	5
18827	T20 x 25 mm	5
18828	T25 x 25 mm	5
18829	T27 x 25 mm	5
18830	T30 x 25 mm	5
18831	T40 x 25 mm	5
18832	T45 x 25 mm	5

BIT T



S2



No.	specification		No.	specification	
17980	T30 x 35 mm	3	17982	T45 x 35 mm	3
17981	T40 x 35 mm	3	17983	T50 x 35 mm	3

BIT TTA



S2



No.	specification	
18835	TTα 5 x 25 mm	5
18836	TTα 6 x 25 mm	5
18837	TTα 7 x 25 mm	5
18838	TTα 8 x 25 mm	5
18839	TTα 9 x 25 mm	5
18840	TTα 10 x 25 mm	5
18841	TTα 15 x 25 mm	5
18842	TTα 20 x 25 mm	5
18843	TTα 25 x 25 mm	5
18844	TTα 27 x 25 mm	5
18845	TTα 30 x 25 mm	5
18846	TTα 40 x 25 mm	5
18847	TTα 45 x 25 mm	5

BIT T



S2



No.	specification		No.	specification	
17970	T20 x 75 mm	3	17974	T45 x 75 mm	3
17971	T25 x 75 mm	3	17975	T50 x 75 mm	3
			17972	T30 x 75 mm	3
			17973	T40 x 75 mm	3
			17976	T55 x 75 mm	3

BIT SD



S2



No.	specification	
18855	SD 6 x 25 mm	5
18856	SD 8 x 25 mm	5

BIT TW



S2



No.	specification	
18860	TW 1 x 25 mm	5
18861	TW 2 x 25 mm	5
18862	TW 3 x 25 mm	5
18863	TW 4 x 25 mm	5

BIT SQ



S2



No.	specification	
18850	SQ 0 x 25 mm	5
18851	SQ 1 x 25 mm	5
18852	SQ 2 x 25 mm	5
18853	SQ 3 x 25 mm	5

BIT



S2



No.	specification	
18866	5/32 x 25 mm	5
18867	3/16 x 25 mm	5

BIT TS



S2



No.	specification	
18864	TS 4 x 25 mm	5
18865	TS 6 x 25 mm	5

BIT XZN



No.	specification	MOQ
18870	M4 x 25 mm	5
18871	M5 x 25 mm	5
18872	M6 x 25 mm	5
18873	M8 x 25 mm	5
18874	M10 x 25 mm	5



DRY WALL BIT

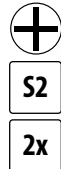

No.	specification	MOQ
18795	PH 2 x 25 mm	24
18796	PH 2 x 55 mm	24



BIT ADAPTER



1/4" ↔ 1/4"

No.	specification	MOQ
18868	25 mm	5
18869	50 mm	5



ADAPTER RATCHET 1/4" - BIT



1/4" ↔ 1/4"

No.	specification	MOQ
18619		5



MAGNETIC BIT HOLDER



No.	specification	MOQ
18600	1/4' x 60 mm	5

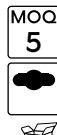

MAGNETIC BIT HOLDER

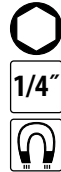

No.	specification	MOQ
18797	1/4' x 60 mm	1



MAGNETIC BIT HOLDER



No.	specification	MOQ
18601	1/4' x 60 mm	5

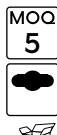

MAGNETIC BIT HOLDER

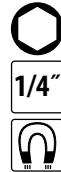

No.	specification	MOQ
18798	1/4' x 60 mm	1



MAGNETIC BIT HOLDER



No.	specification	MOQ
18602	1/4' x 60 mm	5

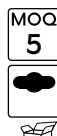

MAGNETIC BIT HOLDER

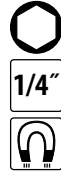

No.	specification	MOQ
18799	1/4' x 60 mm	1



BIT HOLDER, SPRUNG



No.	specification	MOQ
18609	1/4' x 70 mm	1



SLIDING BIT HOLDER



No.	specification	MOQ
18607	80 mm	25



ADAPTER 1/4"



ADAPTER - SADA

-
- 1/4"
- S2
-



- MOQ 5
-

No.	specification		No.	specification	
18610	6 mm	5	18613	10 mm	5
18611	7 mm	5	18614	12 mm	5
18612	8 mm	5	18615	13 mm	5

-
- 1/4"
- CrV
-
- 8x



No.	specification	
18618	6, 7, 8, 9, 10, 11, 12, 13 mm	10

BIT SET AND ADAPTERS



-
- 1/4"
- S2
- TiN
-



- 10x ⊕ 18630 PH0
- 10x ⊕ 18631 PH1
- 10x ⊕ 18632 PH2
- 10x ⊕ 18633 PH3
- 10x ⊕ 18635 PZ0
- 10x ⊕ 18636 PZ1
- 10x ⊕ 18637 PZ2
- 10x ⊕ 18638 PZ3
- 10x ⊕ 18761 PH1 TiN
- 10x ⊕ 18762 PH2 TiN
- 10x ⊕ 18763 PH3 TiN
- 10x ⊕ 18766 PZ1 TiN
- 10x ⊕ 18767 PZ2 TiN
- 10x ⊕ 18768 PZ3 TiN
- 10x ⊕ 18770 PH1 DIAMANT
- 10x ⊕ 18771 PH2 DIAMANT
- 10x ⊕ 18775 PZ1 DIAMANT
- 10x ⊕ 18776 PZ2 DIAMANT
- 10x ⊙ 18814 4,0HTa
- 10x ⊙ 18815 5,0HTa
- 10x ⊙ 18842 20TTa
- 10x ⊙ 18845 30TTa
- 10x ⊕ 18795 drywall bit
- 5x 18612 adapter 1/4" 8mm
- 5x 18613 adapter 1/4" 10mm
- 5x 18600 magnetic bit holder 1/4" 60mm
- 5x 18601 magnetic quick release bit holder 1/4" 60mm
- 5x 18602 magnetic bit holder - screwcap 1/4" 65mm



No.	specification
18993	



BIT SET



-
- 1/4"
- S2
- TiN



- 10x ⊕ 18631 PH1
- 10x ⊕ 18632 PH2
- 10x ⊕ 18633 PH3
- 10x ⊕ 18636 PZ1
- 10x ⊕ 18637 PZ2
- 10x ⊕ 18638 PZ3
- 10x ⊕ 18761 PH1 TiN
- 10x ⊕ 18762 PH2 TiN
- 10x ⊕ 18763 PH3 TiN
- 10x ⊕ 18766 PZ1 TiN
- 10x ⊕ 18767 PZ2 TiN
- 10x ⊕ 18768 PZ3 TiN
- 10x ⊙ 18804 H 4
- 10x ⊙ 18805 H 5
- 10x ⊙ 18825 T 10
- 10x ⊙ 18826 T 15
- 10x ⊙ 18827 T 20
- 10x ⊙ 18828 T 25
- 10x ⊙ 18830 T 30
- 10x ⊙ 18831 T 40

No.	specification
18994	



BIT SET



-
- 1/4"**
- S2**
-
- 32x**

· magnetic quick release bit holder



- S 3 · 4 · 5 · 6
- PH 1 · 2 · 3
- PZ 1 · 2 · 3
- H 3 · 4 · 5 · 6
- T 10 · 15 · 20 · 25 · 27 · 30 · 40
- TTa 10 · 15 · 20 · 25 · 27 · 30 · 40



No. specification
18905

5

BIT SET



-
- 1/4"**
- S2**
-
- 57x**

· magnetic quick release bit holder



- S 4 · 5 · 6
- PH 1 · 2 · 3
- PZ 1 · 2 · 3
- H 3 · 4 · 5 · 6
- T 10 · 15 · 20 · 25 · 27 · 30 · 40
- TTa 10 · 15 · 20 · 25 · 27 · 30 · 40



No. specification
18906

5

BIT SET



-
- 1/4"**
- S2**
- 33x**
-

- HTa 2 · 2.5 · 3 · 4 · 5 · 6
5/32" · 9/64" · 1/8"
7/64" · 3/32" · 5/64"
- SD 4 · 6 · 8 · 10
- TS 6 · 8 · 10
- TW 1 · 2 · 3 · 4
- TTa 8 · 10 · 15 · 20 · 25 · 27 · 30 · 35 · 40

magnetic bit holder

No. specification
18900



10

BIT SET



-
- 1/4"**
- S2**
- 33x**
-

- S 3 · 4 · 5 · 6 · 7
- PH 0 · 1 · 2 · 3
- PZ 1 · 2 · 3
- H 2 · 2.5 · 3 · 4 · 5 · 6
- T 10 · 15 · 20 · 25 · 30 · 40

magnetic bit holder

No. specification
18901



10

BIT SET



-
- 1/4"**
- S2**
-
- 100x**



- S 3 · 4 · 4.5 · 5 · 5.5 · 6 · 6.5 · 7 · 8
- PH 0 · 1 · 2 · 3
- PZ 0 · 1 · 2 · 3
- SQ 0 · 1 · 2 · 3
- T 8 · 10 · 15 · 20 · 25 · 27 · 30 · 40 · 45
- TTa 8 · 10 · 15 · 20 · 25 · 27 · 30 · 35 · 40
- H 1.5 · 2 · 2.5 · 3 · 4 · 5 · 5.5 · 6 · 8 mm
1/16" · 5/64" · 3/32" · 7/64" · 1/8" · 9/64"
5/32" · 3/16" · 7/32" · 1/4"
- HTa 2 · 2.5 · 3 · 4 · 5 · 6 mm
5/64" · 3/32" · 7/64" · 1/8" · 9/64" · 5/32"
- SD 4 · 6 · 8 · 10
- TS 6 · 8 · 10
- TW 1 · 2 · 3 · 4
- 2-wing 1 · 2 · 3
- XZN 5 · 6 · 8

magnetic bit holder

„Y“ holder

1/4" DR screwdriver bit holder

1/4" bit adapter: 25mm, 50mm

No. specification
18909



10

BIT SET

S2
20x



- ⊖ S 4 · 5 · 6 · 7
- ⊕ PH 1 · 2 · 3
- ⊛ PZ 1 · 2 · 3
- H 4 · 5 · 6
- ⊛ T 10 · 15 · 20 · 25
- SQ 1 · 2 · 3



No. specification
18907 10

BIT SET

CrV
TiN
10x



- ⊖ S 4 · 5 · 6 · 7
- ⊕ PH 1 · 2 · 3
- ⊛ PZ 1 · 2 · 3



No. specification
18440 10

BIT SET

HOBBY
7x



- ⊖ S 3 · 5 · 7
- ⊕ PH 1 · 2 · 3

magnetic bit holder

No. specification
18430 20

BIT SET

1/4"
CrV
41x



- ⊖ S 3 · 4 · 4,5 · 5 · 5,5 · 6 · 7
- ⊕ PH 1 · 2 · 3
- ⊛ PZ 1 · 2 · 3
- H 2 · 3 · 4 · 5
- ⊛ T 20 · 30
- 1/4" 4 · 4,5 · 5 · 5,5 · 6 · 7 · 8 · 9 · 10
5/32" · 3/16" · 7/32" · 1/4" · 9/32" · 5/16" · 11/32" · 3/8" · 7/16"

magnetic screwdriver
bit holder
2 pcs adapter

No. specification
18916 10

BIT SET

CrV
1/4"
40x



- ⊖ S 3 · 3,5 · 4 · 5,5
- ⊕ PH 0 · 1 · 2 · 3
- ⊛ PZ 0 · 1 · 2 · 3
- H 3 · 4
- ⊛ T 10 · 15 · 20 · 25 · 27 · 30
- 1/4" 4 · 4,5 · 5 · 5,5 · 6 · 7 · 8 · 9 · 10 · 11 · 13

screwdriver holder 1/4"
magnetic bit holder

No. specification
18915 10

SET OF TOOLS

1/4"
CrV
23x



- ⊖ S 5 · 6 mm
- ⊕ PH 1 · 2
- H 3 · 4 · 5 · 6
- ⊛ T 15 · 20 · 25 · 30
- 1/4" 4 · 5 · 6 · 7 · 8 · 9 · 10 · 12 · 13 mm
- 75 mm 1/4"
- 1/4" → 1/4"

No. specification
18421 1

SET OF TOOLS

35x



- 120mm
- 125mm
- 115mm
- 150mm max. 19mm
- 9mm
- 1/4" 160mm
- 5 · 6 · 7 · 8 · 9 · 10 · 11 mm
- 1/4"
- 1/4"
- ⊖ S 4 · 6 mm
- ⊕ PH 1 · 2 · 3
- ⊛ PZ 1 · 2
- H 4 · 5 · 6

No. specification
17260 1

SET OF TOOLS

FESTA

NEW

CrV

S2

1/4"

1/2"

72T

122x



- 1/2", 1/4"
- 1/4" · 4-5-6-7-8-9mm
- 1/2" · 10-12-13-14-17-19mm
- 1/4" · 4-4.5-5-5.5-6-7-8-9-10-11-12-13-14mm
- 1/2" · 12-13-14-15-16-17-18-19-20-21-22-24mm
- 1/2", 1/4"
- 1/4" · 1/4"
- 1/4" · 150mm
- 1/2" · 254mm
- 1/2", 1/4"
- 1/2" · 16-21mm
- 1/4" · 150mm
- 1/2" · E10-E12-E14-E16-E18-E20-E22-E24
- 1/4" · S 3 · 4 · 5 · 6
- 1/4" · PH 0 · 1 · 2
- 1/4" · PZ 0 · 1 · 2
- 1/4" · S 4 · 5.5 · 6.5
- 1/4" · PH 1 · 2 · 3
- 1/4" · PZ 2 · 3
- 1/4" · H 3 · 4 · 5 · 6
- 1/4" · T 8 · 10 · 15 · 20 · 25
- 1/4" · TTa 10 · 15 · 20 · 25 · 40
- 2 · 2.5 · 3 · 4 · 5 · 6 · 7 · 8 · 10mm
- 8-9-10-11-12-13-14-15-16-17-18-19mm
- S 4x100 · 6,5x150
- PH 2x100 · 3x150
- 180mm
- 160mm
- 160mm
- 250mm
- 300g



No. specification

17238

1

SET OF TOOLS

60x



- 160 mm
- 160 mm
- 300 g
- 1/4" 45T
- 4 · 5 · 6 · 7 · 8 · 9 · 10 · 11 · 12 · 13 mm
- 1/4" 75 mm
- 1,5 · 2 · 2,5 · 3 · 4 · 5 · 6 · 8 · 10 mm
- S 3 · 4 · 5 · 6 mm
- PH 0 · 1 · 2 · 3
- PZ 0 · 1 · 2 · 3
- T 10 · 15 · 20 · 25
- H 3 · 4 · 5 · 6
- S 5x100 mm
- PH 1x100 · 2x100 mm
- S 2,5x50 mm
- PH 00x50 · 0x50 mm
- AC 100-250 V
- 200 mm max. 22 mm
- 10x11 · 12x13 · 14x15 · 16x17 mm
- 18 mm
- 2 m | 13 mm



No. specification

17259

1

SET OF TOOLS

32x



- 1/4" 5 · 6 · 7 · 8 · 9 · 10 · 11 · 12 mm
- 1/4"
- 1/4"
- AC 230 V
- PH 0, SL 3
- 9x 1,5-10 mm
- 160 mm
- S 3 · 4 · 5 · 6 mm
- PH 0 · 1 · 2 · 3
- H 4 · 5
- PH 2x100, S 6x100
- 18 mm
- 1 m
- 300 g



No. specification

17247

1

HEX KEY SET



CrV

9x

- H 1,5 mm
- H 2 mm
- H 2,5 mm
- H 3 mm
- H 4 mm
- H 5 mm
- H 6 mm
- H 8 mm
- H 10 mm



No. specification

18496

10

HEAD HEX KEY SET



CrV

9x

- H 1,5 mm
- H 2 mm
- H 2,5 mm
- H 3 mm
- H 4 mm
- H 5 mm
- H 6 mm
- H 8 mm
- H 10 mm



No. specification

18500

10

HEX KEY SET - LONG



CrV

9x

- H 1,5 mm
- H 2 mm
- H 2,5 mm
- H 3 mm
- H 4 mm
- H 5 mm
- H 6 mm
- H 8 mm
- H 10 mm



No. specification

18490

10

HEAD HEX KEY SET



CrV

9x

- H 1,5 mm
- H 2 mm
- H 2,5 mm
- H 3 mm
- H 4 mm
- H 5 mm
- H 6 mm
- H 8 mm
- H 10 mm



No. specification

18498

10

HEAD HEX KEY SET



CrV

9x

- 1/16"
- 5/64"
- 3/32"
- 1/8"
- 5/32"
- 3/16"
- 1/4"
- 5/16"
- 3/8"



No. specification

18493

10

TORX SET



CrV

9x

- T 10 mm
- T 15 mm
- T 20 mm
- T 25 mm
- T 27 mm
- T 30 mm
- T 40 mm
- T 45 mm
- T 50 mm



No. specification

18497

10

HEAD HEX KEY SET - LONG



CrV

9x

- H 1,5 mm
- H 2 mm
- H 2,5 mm
- H 3 mm
- H 4 mm
- H 5 mm
- H 6 mm
- H 8 mm
- H 10 mm



No. specification

18492

10

TORX SET - LONG



CrV

9x

- T 10 mm
- T 15 mm
- T 20 mm
- T 25 mm
- T 27 mm
- T 30 mm
- T 40 mm
- T 45 mm
- T 50 mm



No. specification

18491

10

HEX KEY



DIN 911



CrV



No.	specification	
18540	1,5 mm 14 x 45 mm	1
18541	2 mm 16 x 50 mm	1
18542	2,5 mm 18 x 56 mm	1
18543	3 mm 20 x 63 mm	1
18544	4 mm 25 x 70 mm	1
18545	5 mm 28 x 80 mm	1
18546	6 mm 32 x 90 mm	1
18547	7 mm 34 x 95 mm	1
18548	8 mm 36 x 100 mm	1
18549	9 mm 38 x 105 mm	1
18550	10 mm 40 x 112 mm	1
18551	11 mm 42 x 120 mm	1
18552	12 mm 45 x 125 mm	1
18553	13 mm 50 x 130 mm	1
18554	14 mm 56 x 140 mm	1
18557	17 mm 63 x 160 mm	1
18559	19 mm 70 x 180 mm	1
18562	22 mm 80 x 200 mm	1
18567	27 mm 100 x 250 mm	1
18572	32 mm 125 x 315 mm	1

HEAD HEX KEY - LONG



CrV



No.	specification	
18575	1,5 mm 15 x 75 mm	1
18576	2 mm 17 x 81 mm	1
18577	2,5 mm 18 x 87 mm	1
18578	3 mm 20 x 96 mm	1
18579	4 mm 24 x 107 mm	1
18580	5 mm 30 x 120 mm	1
18581	6 mm 33 x 136 mm	1
18582	7 mm 34 x 144 mm	1
18583	8 mm 36 x 153 mm	1
18584	9 mm 38 x 155 mm	1
18585	10 mm 40 x 171 mm	1
18586	11 mm 40 x 230 mm	1
18587	12 mm 42 x 250 mm	1
18588	13 mm 45 x 260 mm	1
18589	14 mm 56 x 280 mm	1
18593	17 mm 61 x 290 mm	1

HEX KEY - LONG



CrV



No.	specification	
18466	T7	1
18468	T9	1
18476	T45	1
18477	T50	1

HEAD HEX KEY - LONG



CrV



No.	specification	
18510	1,5 mm 15 x 75 mm	1
18511	2 mm 17 x 81 mm	1
18512	2,5 mm 18 x 87 mm	1
18513	3 mm 20 x 96 mm	1
18514	4 mm 24 x 107 mm	1
18515	5 mm 30 x 120 mm	1
18516	6 mm 33 x 136 mm	1
18518	8 mm 36 x 153 mm	1
18519	9 mm 38 x 155 mm	1
18520	10 mm 40 x 171 mm	1
18521	11 mm 40 x 230 mm	1
18522	12 mm 42 x 250 mm	1
18523	13 mm 45 x 260 mm	1
18524	14 mm 56 x 280 mm	1
18527	17 mm 61 x 290 mm	1

HEX KEY SET



CrV



No.	specification	
18508	1,5 · 2 · 2,5 · 3 · 4 · 5 · 6 mm	1

T HANDLE INBUS KEY HEXAGONAL - SET



CrV

9x



- 2 mm
- 2,5 mm
- 3 mm
- 4 mm
- 5 mm
- 6 mm
- 7 mm
- 8 mm
- 10 mm



No. specification
18494

6

T HANDLE KEY TORX - SET



CrV

9x



- T 10
- T 15
- T 20
- T 25
- T 27
- T 30
- T 40
- T 45
- T 50



No. specification
18495

6

HEX KEY SET



8x

HOBBY



No. specification
18499 2 · 2,5 · 3 · 4 · 5 · 6 · 8 · 10 mm

1

T HANDLE KEY TORX



CrV



No.	specification	
17350	T 7	10
17351	T 8	10
17352	T 9	10
17353	T 10	10

No.	specification	
17357	T 27	10
17359	T 40	10
17360	T 45	10
17361	T 50	10



HAMMERS and MALLETS

HAMMER



DIN 1041



· ash handle

No.	specification	
19081	100 g	1
19082	200 g	1
19083	300 g	1
19084	400 g	1
19085	500 g	1

No.	specification	
19086	600 g	1
19088	800 g	1
19090	1000 g	1
19092	1500 g	1
19095	2000 g	1



MALLET



DIN 1041



· ash handle

No.	specification		No.	specification	
19096	3000 g	1	19106	6000 g	1
19097	4000 g	1	19108	8000 g	1
19098	5000 g	1	19109	10000 g	1

MALLET



DIN 6475



· ash handle

No.	specification	
19074	5000 g	1
19075	6000 g	1
19076	8000 g	1
19077	10000 g	1

HAMMER FIBERGLASS



· fiberglass handle

No.	specification		No.	specification	
19021	100 g	12	19026	600 g	6
19022	200 g	12	19028	800 g	6
19023	300 g	12	19030	1000 g	6
19024	400 g	12	19031	1500 g	6
19025	500 g	12	19032	2000 g	1

MALETT FIBERGLASS



DIN 6475



· fiberglass handle

No.	specification		No.	specification	
19066	1000 g	4	19070	3000 g	4
19067	1250 g	4	19071	4000 g	4
19068	1500 g	4	19058	5000 g	4
19069	2000 g	2	19059	6000 g	2

HAMMER

DIN 1041



· circular wedge

No.	specification		No.	specification	
19001	100 g	12	19006	600 g	6
19002	200 g	12	19008	800 g	6
19003	300 g	6	19010	1000 g	6
19004	400 g	6	19015	1500 g	6
19005	500 g	6	19020	2000 g	6

MALETT

DIN 6475



· circular wedge

No.	specification		No.	specification	
19053	1000 g	6	19055	2000 g	6
19050	1250 g	6	19056	3000 g	6
19054	1500 g	6	19057	4000 g	6

MALLET FIBERGLASS



· fiberglass handle

No.	specification	
19034	3000 g	4
19036	4000 g	4

CLAW HAMMER FIBERGLASS



· fiberglass handle

No.	specification	
19064	450 g	6

ROOF HAMMER FIBERGLASS



· fiberglass handle

No.	specification	
19061	600 g	6

MASONRY HAMMER FIBERGLASS



· fiberglass handle

No.	specification	
19151	600 g	6

CLAW HAMMER MONOLIT



No.	specification	
19063	450 g	6

ROOF HAMMER MONOLIT



No.	specification	
19062	600 g	6

MASONRY HAMMER MONOLIT



No.	specification	
19150	600 g	6

ROOF HAMMER



No.	specification	
19100	600 g	6

CLAW HAMMER



No.	specification	
19065	600 g	6

ROOF HAMMER



No.	specification	
19060	600 g	6

MALETT



No.	specification	
19051	1000 g	6
19052	1500 g	6

HAMMER - AXE



No.	specification	
19303	600 g	6

MASONRY HAMMER



ash handle

No.	specification	
19149	44 mm	1

MASONRY HAMMER



ash handle

No.	specification	
19124	24 mm	1
19136	36 mm	1
19148	48 mm	1

WELDING HAMMER



No.	specification	
19115	300 g	1

ASH HANDLE FOR HAMMER



No.	specification	
61240		1

ASH HANDLE FOR HAMMER



No.	specification	for hammer	
61320	26 cm	19081	10
61321	28 cm	19082	10
61322	30 cm	19083	10
61323	31 cm	19084	10
61324	32 cm	19085	10

No.	specification	for hammer	
61325	33 cm	19086	10
61326	35 cm	19088	10
61327	36 cm	19090	10
61328	38 cm	19092	10
61329	40 cm	19095	10

ASH HANDLE FOR MALETT



No.	specification	for hammer	
61330	80 cm	19074, 19075	10
61331	90 cm	19076, 19077	10

CONICAL CIRCULAR WEDGE



No.	specification	
19430	6 mm	10
19431	8 mm	10
19432	10 mm	10
19433	12 mm	10
19434	14 mm	10
19435	16 mm	10

FORGED WEDGE



No.	specification	
19440	narrow	10
19441	middle	10
19442	wide	10
19443	wide S	10

STEEL WEDGE



3x



No.	specification	
19398	20 x 25 x 5	1
19399	30 x 40 x 5	1

WOODEN MALLET

FESTA



· beech wood

No.	specification		
19202	Ø 60 x 120 mm 350 g	1	1

WOODEN MALLET

FESTA



· beech wood

No.	specification		
19200	80 x 60 mm 520 g	1	1

RUBBER MALLET

FESTA



· ash handle



No.	specification		
19245	Ø 55 mm 400 g	1	1
19246	Ø 60 mm 800 g	1	1
19247	Ø 70 mm 1000 g	1	1
19248	Ø 95 mm 2000 g	1	1
19249	Ø 115 mm 3000 g	1	1

RUBBER MALLET

FESTA



· fiberglass handle



No.	specification		
19270	Ø 55 mm	6	
19271	Ø 65 mm	6	
19272	Ø 90 mm	6	

RUBBER MALLET

FESTA



No.	specification		
19255	Ø 55 mm	6	
19265	Ø 65 mm	6	
19290	Ø 90 mm	6	

WHITE RUBBER MALLET

FESTA



No.	specification		
19294	Ø 65 mm	6	
19295	Ø 90 mm	6	

RUBBER MALLET BLACK-WHITE



No.	specification		
19254	Ø 65 mm	6	

RUBBER MALLET



No.	specification	
19251	Ø 55 mm 400 g	12
19252	Ø 65 mm 700 g	6
19253	Ø 90 mm 1300 g	4

BRASS MALETT



· fiberglass handle

No.	specification	
19211	Ø 30 mm 500 g	1

SILICON HAMMER



No.	specification	
19297	Ø 35 mm	12

NYLON MALLET



· fiberglass handle

No.	specification	
19209	Ø 34 mm	6

MALLET WITH REPLACEABLE HEADS



NEW



No.	specification	
19208	Ø 40 mm	1



AXES

FESTA

AXE

FESTA

DIN 5131
DIN 7294



- ash handle
- circular wedge

No.	specification		No.	specification	
19380	600 g	1	19384	1400 g	1
19381	800 g	1	19385	1600 g	1
19382	1000 g	1	19387	2000 g	1
19383	1250 g	1			

CANPERTERS AXE

FESTA



- ash handle

No.	specification	
19340	700 g	22

AXE

FESTA

DIN 5129



- ash handle
- circular wedge

No.	specification	
19389	3000 g	1
19388	4000 g	1

AXE

FESTA

DIN 7294



- ash handle
- circular wedge

No.	specification	
19391	2000 g	1

AXE

ASH HANDLE FOR AXE



No.	specification	
19306	600 g	24
19308	800 g	24
19310	1000 g	24
19312	1250 g	12
19314	1500 g	12

No.	specification	for hammer	
61340	36 cm	19380	10
61341	40 cm	19381, 19340	10
61342	50 cm	19382	10
61343	70 cm	19383, 19384	10

No.	specification	for hammer	
61344	80 cm	19385, 19391	10
61345	90 cm	19387	10
61346	90 cm	19388, 19389	10

AXE FIBERGLASS



· fiberglass handle

No.	specification	
19326	600 g	6
19328	800 g	24
19330	1000 g	12

CAMP AXE FIBERGLASS



· fiberglass handle

No.	specification	
19301	500 g	6

SPLITTING AXE FIBERGLASS



SPLITTING AXE FIBERGLASS



· fiberglass handle

No.	specification	
19392	1000 g	6



· fiberglass handle

No.	specification	
19390	2000 g	6

AXE FIBERGLASS



AXE FIBERGLASS



· fiberglass handle

No.	specification	
19370	3000 g	4
19371	4000 g	4



· fiberglass handle

No.	specification	
19344	1250 g	6

AXE



Black Eagle



No.	specification	
19354	600 g	6
19356	1200 g	5
19357	1800 g	1

AXE



Black Eagle



No.	specification	
19360	2700 g splitting	6

SPLITTING WEDGE



No.	weight	specification	
19397	2000 g	55 x 210 x 45 mm	10
19465	2500 g	65 x 230 x 45 mm	10

SPLITTING WEDGE FOUR-SPOKE



No.	weight	specification	
19469	2500 g	165 x 87 mm	10

SPLITTING WEDGE



No.	weight	specification	
19394	1000 g	35 x 180 x 40 mm	6
19395	2000 g	40 x 255 x 55 mm	6
19396	2500 g	40 x 260 x 55 mm	10

SPLITTING WEDGE



No.	specification	
19462	175 x 65 x 20 mm	1
19463	230 x 70 x 30 mm	1
19464	240 x 75 x 40 mm	1

FESTA®



OVAL PULLER



CROWBAR

14 mm

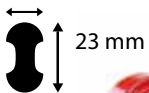

No.	specification	
19424	400 mm	6
19425	600 mm	6
19426	800 mm	6
19427	1000 mm	6

No.	specification	
19416	600 mm Ø 16 mm	4
19422	800 mm Ø 16 mm	4
19421	1000 mm Ø 18 mm	4

CROWBAR

NEW



NAIL PULLER



No.	specification	
19423	380 x 35 x 6 mm	6

No.	specification	
19415	300 mm Ø 15 mm	6

FLAT CHISEL



CrV



No.	specification	the tip width	
19406	300 mm	25 mm	5
19407	400 mm	30 mm	5

POINT CHISEL



CrV



No.	specification		
19408	250 mm		5
19409	350 mm		5

FLAT CHISEL



CrV



No.	specification	the tip width	
19460	300 mm	25 mm	5
19470	400 mm	30 mm	5

POINT CHISEL



No.	specification		
19400	250 mm		12
19403	350 mm		6

FLAT CHISEL



No.	specification	the tip width	
19401	250 mm	19 mm	12
19404	350 mm	22 mm	6

FLAT CHISEL



No.	specification	the tip width	
19402	250 mm	50 mm	6
19405	350 mm	50 mm	6

FLAT CHISEL



CrV



No.	specification	the tip width	
19410	200 mm	20 mm	10
19411	250 mm	25 mm	10
19412	300 mm	25 mm	10
19418	400 mm	25 mm	5
19419	500 mm	25 mm	5

FLAT CHISEL

CrV



No.	specification	the tip width	
19436	200 mm	20 mm	15



CHISELS



CHISEL SET WITH SHARPPENER STONE



CrV 5x

- 6 mm
- 10 mm
- 15 mm
- 20 mm
- 25 mm



No. specification

19451



10

CHISEL SET



CrV 4x

- 6 mm
- 12 mm
- 19 mm
- 25 mm



No. specification

19457



10

CHISEL



CrV



No.	specification		No.	specification	
19490	6 mm 275 mm	6	19496	18 mm 280 mm	6
19491	8 mm 275 mm	6	19497	20 mm 280 mm	6
19492	10 mm 275 mm	6	19498	22 mm 280 mm	6
19493	12 mm 275 mm	6	19499	25 mm 280 mm	6
19494	14 mm 275 mm	6	19501	32 mm 290 mm	6
19495	16 mm 275 mm	6	19502	38 mm 290 mm	6

MULTIFUNCTION CHISEL



INOX



No. specification

16231 20 | 80 mm



12

CHISEL SET

4x

- 8 mm
- 12 mm
- 19 mm
- 25 mm



No. specification

19450



20

CHISEL SET

4x

- 8 mm
- 12 mm
- 19 mm
- 25 mm



No. specification

19455



30

CHISEL SET



JACK - PLANE



CrV

8x



No.	specification	
19510	220 x 65 x 130 mm, knife 48 mm	1

JACK - PLANE



No.	specification	
19515	200 x 55 x 130 mm, knife 39 mm	1

JACK - PLANE



No.	specification	
19520	225 x 27 x 155 mm, knife 27 mm	1

CHISEL SET

CrV

12x



No.	specification	
19458	365 125mm	1

TINMANS SET

7x



No.	specification	
19110		5





FESTA®



STAPLERS

STAPLE GUN 5 IN 1







-  | 6 - 14 mm
23960 - 23964
23760 - 23764,
23906 - 23914
-  | 10 - 14 mm
23965
-  | 15 mm
23966
-  | 15 mm
23967

No.	specification
23927	



STAPLE GUN 4 IN 1





-  | 6 - 14 mm
23960 - 23964
-  | 12 mm
23965
-  | 14 mm
23966
-  | 14 mm
23967

No.	specification
23924	



STAPLE GUN 3 IN 1



-  | 6 - 14 mm
23960 - 23964
-  | 14 mm
23966
-  | 14 mm
23967

No.	specification
23923	



STAPLE GUN



-  53 | 4 - 14 mm
23904 - 23914,
23760 - 23765

No.	specification
23925	4 - 14 mm with lock out



STAPLES EXTRACTOR



No.	specification
23945	



STAPLE GUN



53 | 4 - 14 mm
23760 - 23765,
23904 - 23914

No.	specification	
23800		20

STAPLE GUN



0,7 mm
53 | $\alpha=9-11$ mm, $b=5,5$ mm, $c=6,4$ mm

No.	specification	
23920		4

STAPLE HAMMER



10,4 mm
1,2 mm
53 | 6 - 10 mm
23960 - 23962

No.	specification	
23922		10

STAPLE HAMMER



10,4 mm
1,2 mm
53 | 6 - 10 mm
23960 - 23962

No.	specification	
23928		6

STAPLES EXTRA

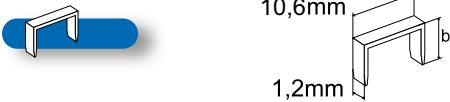

No.	specification	
23960	b=6 mm, 1000 pcs	50
23961	b=8 mm, 1000 pcs	50
23962	b=10 mm, 1000 pcs	50
23963	b=12 mm, 1000 pcs	50
23964	b=14 mm, 1000 pcs	50

STAPLES



No.	specification	
23965	$\alpha=12$ mm, $b=6,5$ mm, $c=7,5$ mm, 1000 TW	50

NAILS



No.	specification	
23966	nails 14 mm 1000 TW	100

NAILS



No.	specification	
23967	nails 14 mm 1000 TW	100

STAPLES - TYPE 53

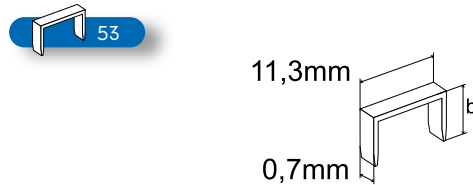

No.	specification	
23904	b=4 mm 1000 pcs	200
23906	b=6 mm 1000 pcs	200
23908	b=8 mm 1000 pcs	200
23910	b=10 mm 1000 pcs	200
23912	b=12 mm 1000 pcs	200
23914	b=14 mm 1000 pcs	200

STAPLES - TYPE 53

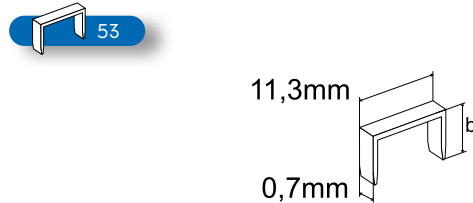

No.	specification	
23760	b=4 mm 2000 pcs	10
23761	b=6 mm 2000 pcs	10
23762	b=8 mm 2000 pcs	10
23763	b=10 mm 2000 pcs	10
23764	b=12 mm 2000 pcs	10

STAPLE HAMMER



 140 | 6 - 10 mm
24535-24537,
24540-24542,
24567

No. specification  20

24510

STAPLE HAMMER



 13 | 4 - 6 mm
24530
24533

No. specification  20

24511

STAPLE GUN



 140 | 6 - 14 mm
24535-24539,
24540-24543,
24567

No. specification  20

24515

STAPLE GUN



 140 | 6 - 8 mm
24535-24536,
24540-24541,
24567

No. specification  20

24516

STAPLE GUN



 13 | 4 - 10 mm
24530 - 24534

No. specification  20

24520

STAPLE GUN



 53 | 6 - 14 mm
24545 - 24547,
24555 - 24558,
24551 - 24552,
24568 - 24569

 8 | 15 mm
24570

No. specification  20

24517



STAPLE GUN



53 | 6 - 14 mm
24545 - 24547,
24555 - 24558,
24551 - 24552,
24568 - 24569

No. specification
24518

20

STAPLE GUN



13 | 4 - 8 mm
24530 - 24531,
24533 - 24534

No. specification
24521

20



STAPLE GUN



53 | 6 - 12 mm
24545 - 24547,
24555 - 24557,
24551 - 24551,
24568 - 24569

7 | 12 - 14 mm
24570

8 | 15 mm
24570

9 | 15 mm
24570

No. specification
24522

20

STAPLE GUN



53 | 4 - 10 mm
24550,
24545 - 24547,
24555 - 24557

No. specification
24519

20

STAPLES HIGH PERFORMANCE - TYPE 53

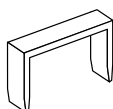

No.	specification	blister pcs	
24550	4 mm	1620	10
24545	6 mm	2130	10
24555	6 mm	5000	10
24546	8 mm	2130	10
24556	8 mm	5000	10
24547	10 mm	2130	10
24557	10 mm	5000	10
24551	12 mm	1080	10
24558	12 mm	5000	10
24552	14 mm	1080	10
24553	20 mm	540	10

STAPLES - STAINLESS TYPE 53 INOX



INOX

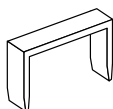

No.	leg length	blister pcs	
24568	6 mm	1080	10
24569	8 mm	1080	10

STAPLES HIGH PERFORMANCE - TYPE 140

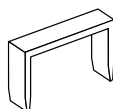

No.	leg length	blister pcs	
24535	6 mm	970	10
24540	6 mm	5000	10
24536	8 mm	970	10
24541	8 mm	5000	10
24537	10 mm	648	10
24542	10 mm	5000	10
24538	12 mm	648	10
24543	12 mm	5000	10
24539	14 mm	648	10

STAPLES - STAINLESS TYPE 140 INOX



INOX

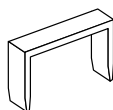

No.	leg length	blister pcs	
24567	10 mm	650	10

STAPLES HIGH PERFORMANCE - TYPE 13

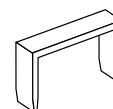

No.	specification	blister pcs	
24530	6 mm	1650	10
24533	6 mm	5000	10
24531	8 mm	1650	10
24534	8 mm	5000	10
24532	10 mm	1100	10



STAPLES HIGH PERFORMANCE - TYPE 606

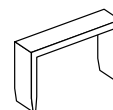

No.	leg length	blister pcs	
24560	12 mm	1200	10
24561	18 mm	600	10
24562	25 mm	600	10

STAPLES HIGH PERFORMANCE - TYPE 90

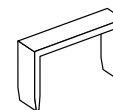

No.	leg length	blister pcs	
24580	20 mm	3000	10
24581	25 mm	3000	10
24582	30 mm	3000	10
24583	35 mm	1500	10
24584	40 mm	1500	10

STAPLES HIGH PERFORMANCE - TYPE 8



No.	leg length	blister pcs	
24570	15 mm	1000	10
24571	20 mm	750	10
24572	25 mm	1000	10
24573	30 mm	1000	10
24577	40 mm	2800	10
24578	50 mm	2800	10

STAPLES - STAINLESS TYPE 8 INOX



No.	leg length	blister pcs	
24575	30 mm	4200	10

STAPLES HIGH PERFORMANCE - TYPE 7

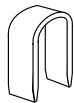

No.	leg length	blister pcs	
24565	14 mm	960	10

STAPLES HIGH PERFORMANCE - TYPE 9



No.	leg length	blister pcs	
24574	15 mm	1000	10



NAILS - TYPE F

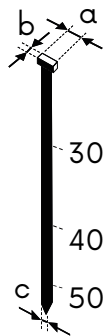

a 2,0 mm
b 1,25 mm
c 0,95 mm

STAPLES

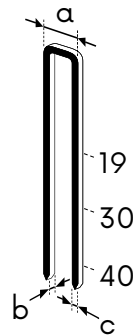

a 5,7 mm
b 1,25 mm
c 0,95 mm

for AKU nailer 28070

No.	specification	
23930	30 mm - 6000 pcs	1
23931	40 mm - 6000 pcs	1
23932	50 mm - 6000 pcs	1

for AKU nailer 28070

No.	specification	
23934	19 mm - 3000 pcs	1
23935	30 mm - 3000 pcs	1
23936	40 mm - 3000 pcs	1



CLAMPS AND VICES

QUICK GRIP CLAMP



· drop forged

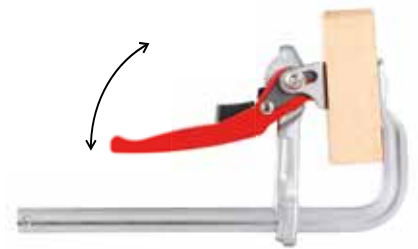

No.	specification		No.	specification	
23560	200 x 80 mm	1	23564	600 x 120 mm	1
23561	300 x 100 mm	1	23565	800 x 120 mm	1
23562	400 x 100 mm	1	23566	1000 x 120 mm	1
23563	500 x 120 mm	1			

QUICK GRIP CLAMP



NEW

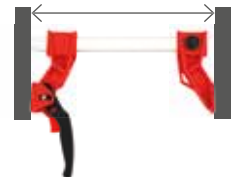

No.	specification	
23570	100 x 80 mm	1
23571	160 x 80 mm	1
23572	200 x 80 mm	1
23573	250 x 80 mm	1
23574	300 x 80 mm	1

STEEL CLAMP



No.	specification		No.	specification		No.	specification	
23670	150 x 105 mm	1	23676	500 x 175 mm	1	23682	1500 x 175 mm	1
23671	200 x 105 mm	1	23677	600 x 175 mm	1	23683	1750 x 175 mm	1
23672	250 x 105 mm	1	23678	700 x 175 mm	1	23684	2000 x 175 mm	1
23673	300 x 105 mm	1	23679	800 x 175 mm	1	23685	2200 x 175 mm	1
23674	350 x 105 mm	1	23680	1000 x 175 mm	1			
23675	400 x 175 mm	1	23681	1250 x 175 mm	1			

CLAMP

DIN 5117



No.	specification	
23506	300 x 120 mm	10
23507	500 x 120 mm	10
23508	800 x 120 mm	6

CLAMP



No.	specification		No.	specification	
23515	150 x 50 mm	50	23530	300 x 50 mm	50
23520	200 x 50 mm	50	23531	300 x 120 mm	20
23525	250 x 50 mm	50	23551	500 x 120 mm	10

QUICK GRIP CLAMP

FESTA



No.	specification	
23625	200 mm	6
23626	300 mm	6
23628	450 mm	6
23630	600 mm	6
23632	760 mm	6

QUICK GRIP CLAMP

FESTA



No.	specification	
23585	150 mm	6
23587	300 mm	6
23589	450 mm	6
23591	600 mm	6

RATCHET CLAMP



span 80 mm

No.	specification	
23605	9' 230 mm	6

PLASTIC CLAMP



No.	specification	
23600	4', span 40 mm	20
23601	6', span 50 mm	12
23602	9', span 80 mm	20

CLAMP SET

3x



No.	specification	
23620	25 mm, 50 mm, 75 mm	6

VICE

FESTA

hardened jaw



No.	specification	
23410	100 mm	1
23411	125 mm	1
23412	150 mm	1

SWIVEL VICE

hardened jaw



No.	specification	
23415	100 mm	1
23416	125 mm	1
23417	150 mm	1

SWIVEL VICE



No.	specification
23407	65 mm

DRILL MACHINE VICE



· hardened jaw

No.	specification	
23400	18 80 mm	10
23401	22 100 mm	10
23402	24 125 mm	5

VICE ALU WITH SWIVEL TABLE 90°

ALU



· range 0 - 65 mm

No.	specification	
23420	65 mm	20

VICE ALU WITH SWIVEL BASE 360°

ALU



No.	specification	
23406	80 mm	24

WORK BENCH

· ideal for cellars



No.	specification	
23660		1

MULTIFUNCTIONAL WORK BENCH



No.	specification	
23650		1

FESTA®

RIVETER

RIVETER

Cr-Mo



INOX



ALU

Cu

FESTA



- Ø 2,4 mm
- Ø 3,2 mm
- Ø 4,0 mm
- Ø 4,8 mm



1

No. 24007 specification 200 mm



RIVETER

Cr-Mo



INOX



ALU

Cu

FESTA



- Ø 2,4 mm
- Ø 3,2 mm
- Ø 4,0 mm
- Ø 4,8 mm



12

No. 24010 specification 250 mm



RIVETER **FESTA**

Cr-Mo

INOX ALU Cu

Ø 2,4 mm
Ø 3,0 mm
Ø 3,2 mm
Ø 4,0 mm
Ø 4,8 mm



No. specification
24017 280 mm

1

RIVETER **FESTA**

Cr-Mo

INOX ALU Cu

Ø 2,4 mm
Ø 3,2 mm
Ø 4,0 mm
Ø 4,8 mm
Ø 6,4 mm



No. specification
24015 530 mm

1

RIVETER **FESTA**

Cr-Mo

ALU Cu

Ø 2,4 mm
Ø 3,0 mm
Ø 3,2 mm
Ø 4,0 mm
Ø 4,8 mm



No. specification
24030 260 mm

24

RIVETER **FESTA**

Cr-Mo

ALU Cu

- adjustable head of riveter
- 2 positions

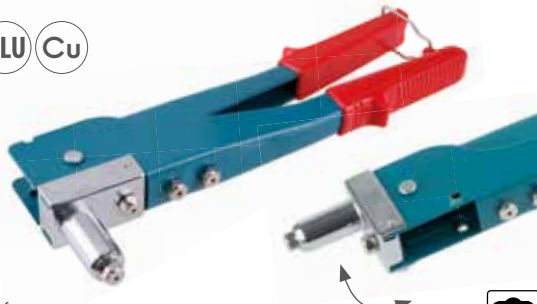

No. specification
24002 260 mm

6

RIVETER WITH MULTI - SIZE BLOCKER **FESTA**

Cr-Mo

ALU Cu

Ø 2,4 mm
Ø 3,2 mm
Ø 4,0 mm
Ø 4,8 mm



No. specification
24006 250 mm

12

RIVETER **FESTA**

Cr-Mo

ALU Cu

Ø 2,4 x 6 mm
Ø 3,2 x 6 mm
Ø 4,0 x 6 mm
Ø 4,8 x 6 mm



No. specification
24005 260 mm

24

RIVETER **FESTA**

Cr-Mo

ALU Cu



No. specification
24020 290 mm

8

RIVETER

ALU



No. specification
24001 260 mm

6

RIVETER

ALU



No. specification
24000 250 mm

24

RIVETER



Cr-Mo

- M3
- M4
- M5
- M6
- M8
- M10



No.	specification
24036	330 mm



1

RIVETER



Cr-Mo

- M3
- M4
- M5
- M6



No.	specification
24035	200 mm



1

RIVETER HEAD

Cr-Mo



• suitable for 24035, 24036



No.	specification	
24038	M3	1
24039	M4	1
24040	M5	1
24041	M6	1
24042	M8	1
24043	M10	1

NUT RIVETING, 20 PCS

ALU

20x



No.	specification	pcs in package
23950	M3 x 9 mm	20
23951	M4 x 11 mm	20
23952	M5 x 12 mm	50
23953	M6 x 14 mm	50
23954	M8 x 16,5 mm	25
23955	M10 x 18 mm	20

ALU RIVET

ALU

50x



No.	specification	
23970	3,2 x 6 mm	25
23971	3,2 x 8 mm	25
23972	3,2 x 10 mm	25
23973	3,2 x 12 mm	25
23974	3,2 x 14 mm	25
23975	4,0 x 6 mm	25
23976	4,0 x 8 mm	25
23977	4,0 x 10 mm	25
23978	4,0 x 12 mm	25
23979	4,0 x 14 mm	25
23985	4,8 x 6 mm	25
23986	4,8 x 8 mm	25
23987	4,8 x 10 mm	25
23988	4,8 x 12 mm	25
23989	4,8 x 14 mm	25



CONNECTING PLIERS FOR PROFILES



No.	specification
17187	350 mm

6

CONNECTING PLIERS FOR PROFILES



No.	specification
17188	250 mm

6

RIVETER FOR PLUG



No.	specification
17189	255 mm

12

TWO LEGS PULLER



No.	max. diameter	depth
23734	Ø 100 mm	50-95 mm
23735	Ø 150 mm	100-150 mm
23736	Ø 200 mm	110-190 mm

1

THREE - LEG PULLER



No.	max. diameter	depth
23730	Ø 100 mm	50-95 mm
23731	Ø 150 mm	100-150 mm
23732	Ø 200 mm	110-190 mm

12

WELDING INVERTER TIG/MMA 160 A



Voltage / frequency:	230 V / 50 Hz
Voltage free:	55 V
Regulatory range welding currents:	10 - 160 A
Diameter of electrode:	1,5 - 4,0 mm
Working cycle:	TIG- 160 A / 60%, MMA - 140 A / 60%
Protection class:	IP 21
Type of welding:	TIG/MMA
Dimensions:	405 x 165 x 270 mm
Technology:	Anti-stick, Arc-force, Hot start, Lift TIG
Weight:	6 kg

No.	specification	
70040	Welding inverter TIG/MMA 160A	1
70045	Spare welding cables	1
70046	Spare heating torch TIG	1



WELDING RUTILE ELECTRODE



certificated

WELDING BASIC ELECTRODE



certificated

No.	specification	
70021	Ø 2,0 x 300 mm	10 pcs
70020	Ø 2,0 x 300 mm	2,5 kg
70026	Ø 2,5 x 300 mm	10 pcs
70025	Ø 2,5 x 300 mm	2,5 kg
70033	Ø 3,2 x 350 mm	10 pcs
70032	Ø 3,2 x 350 mm	5 kg

No.	specification	
70030	NEW Ø 2,0 x 300 mm	2,5 kg
70031	NEW Ø 2,0 x 300 mm	5 kg
70035	Ø 2,5 x 300 mm	2,5 kg
70036	Ø 2,5 x 300 mm	10 pcs
70037	Ø 3,2 x 350 mm	5 kg
70038	Ø 3,2 x 350 mm	10 pcs

SELF-DARKENING WELDING HELMET



CE EN
379



LCD display



View size:	98 x 80 mm
Lens reaction time	1/25 000 s
Darkening	DIN 5-8 / 9-13
UV/IR protection	DIN 16
Optical class	1 1 1 2
Working cycle:	4
Power supply:	Solar cell + replaceable battery CR2450
Operating mode	Welding, grinding



No.	specification	
70064	active	1
70066	replacement protective plexiglass	1

SELF-DARKENING WELDING HELMET - CARBON



SELF-DARKENING WELDING HELMET

2x
CR2032
3V

CARBON

7-15
shade



No.	specification	
70063	active	4

2x AAA

7-15
shade



No.	specification	
70060	active	4

WELDING HELMET

UV-IR
protection

11
shade



No.	specification	
70061		4

WELDING GOGGLES

UV-IR
protection



No.	specification	
70062		1

REPLACEMENT PROTECTIVE GLASS FOR WELDING HELMET

2x



No.	specification	
70065	113 x 80 mm	20

WELDING HAMMER



No.	specification	
19115	300 g	1

ELECTRODE HOLDER



No.	specification	
70070	300 A	1

WELDING PLIERS



No.	specification	
70075	300 A	1

MAGNETIC WELDING HOLDER



No.	specification	load capacity	
70096	150 x 130 x 30 mm · 45°, 90°, 135°	25 kg	10

MAGNETIC WELDING HOLDER



No.	specification	load capacity	
70090	85 x 85 mm · 45°, 90°	9 kg	10

MAGNETIC WELDING HOLDER



No.	specification	load capacity	
70093	95 x 64 mm · 30°, 45°, 60°, 75°, 90°	9 kg	10
70094	120 x 90 mm · 30°, 45°, 60°, 75°, 90°	18 kg	10
70095	137 x 110 mm · 30°, 45°, 60°, 75°, 90°	27 kg	10

MAGNETIC WELDING HOLDER



No.	specification	load capacity	
70091	95 x 109 x 25 mm · 45°, 90°, 135°	13 kg	10
70092	130 x 150 x 32 mm · 45°, 90°, 135°	22 kg	5

THREAD ROD STANLESS

DIN 976 **INOX**



4.8 · strength class

No.	specification		
55311	M 5	1 m	150
55313	M 8	1 m	50
55314	M 10	1 m	25
55315	M 12	1 m	20
55316	M 14	1 m	15
55317	M 16	1 m	15
55318	M 18	1 m	10
55319	M 20	1 m	10

THREAD ROD

DIN 975 **Zn**



4.8 · strength class

No.	specification		
55040	M 4	1 m	200
55050	M 5	1 m	150
55060	M 6	1 m	100
55080	M 8	1 m	50
55100	M 10	1 m	20
55120	M 12	1 m	20
55140	M 14	1 m	15
55160	M 16	1 m	15
55180	M 18	1 m	10
55200	M 20	1 m	10
55220	M 22	1 m	5
55240	M 24	1 m	5
55300	M 30	1 m	5

THREAD ROD

DIN 975



4.8 · strength class

No.	specification		
55041	M 4	1 m	200
55051	M 5	1 m	150
55101	M 10	1 m	20
55121	M 12	1 m	20
55141	M 14	1 m	15
55181	M 18	1 m	10
55201	M 20	1 m	10
55221	M 22	1 m	5
55301	M 30	1 m	5



NUT

DIN 934

Zn



4.8 · strength class

No.	specification		
55350	M 4	100 pcs	1
55351	M 5	100 pcs	1
55352	M 6	100 pcs	1
55353	M 8	100 pcs	1
55354	M 10	100 pcs	1
55355	M 12	100 pcs	1
55356	M 14	100 pcs	1
55357	M 16	100 pcs	1
55358	M 18	100 pcs	1
55359	M 20	10 pcs	1
55360	M 22	10 pcs	1
55361	M 24	10 pcs	1
55362	M 30	10 pcs	1

WASHER

DIN 440R

Zn



No.	specification		
55331	M 5	100 pcs	1
55332	M 6	100 pcs	1
55333	M 8	100 pcs	1
55334	M 10	100 pcs	1
55335	M 12	100 pcs	1
55336	M 14	100 pcs	1
55337	M 16	100 pcs	1
55339	M 20	10 pcs	1
55340	M 22	10 pcs	1
55341	M 24	10 pcs	1
55342	M 30	10 pcs	1



COMPRESSOR 6 L - OILLESS



Voltage / frequency:	230 V / 50Hz
Power consumption:	1,2 kW (1,5HP)
Tank volume :	6 l
Max. pressure:	8 Bar
Speed:	3900 min.
Suction power:	180 l/min.
Filling performance:	116 l/min.
Weight:	10 kg

No. 35360 1



COMPRESSOR 24 L - OILLESS



Output:	1100 W
Power supply:	230 V / 50Hz
Run without load:	2850 min-1
Work pressure:	8 bar
Free Air Intake:	160 l / min
Type:	without oil
Storage capacity:	24 L
Weight:	23 kg

No. 35361 specification 1,1 kW, 24 l 1

COMPRESSOR 24 L



Output:	1500 W
Power supply:	230 V / 50Hz
Run without load:	2850 min-1
Work pressure:	8 bar
Free Air Intake:	200 l / min
Type:	oleic
Storage capacity:	24 L
Weight:	24 kg

No. 35362 specification 1,5 kW, 24 l 1

COMPRESSOR SET



5x

- spray gun with bottom reservoir
- bladder gun with nanometer
- spray gun with top shelf
- blowing guns
- hose with quick couplings



No. specification
48001



COMPRESSOR SET



3x

- blow guns with manometer
- blow guns
- hose with quick couplings



No. specification
48002



SPRAY GUN



No. specification
48015 lower



UNDER COATING GUN



No. specification
48036 lower

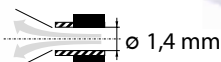

SPRAY GUN



No.	specification	
48020	upper	1

SPRAY GUN



No.	specification	
48021	upper	1
48047	spare nozzle Ø 1,7 mm	1

SPRAY GUN



No.	specification	
48022	upper	1
48046	spare nozzle Ø 1,5 mm	1

BLOW GUN



SPRAY GUN FOR PAINTS AND PLASTERS



No.	specification	
48003		1



- 4 - 6 Bar
- 5 l
- nozzle Ø 4; 6; 8 mm

No.	specification	
48037		1

BLOW GUN



No.	specification	
48005	short	25

BLOW GUN



No.	specification	
48006	medium	25

BLOW GUN



No.	specification	
48007	long	25

RINSER GUN WITH MANOMETR



No.	specification
48010	



GUN HOSE INCLUDED CONNECTORS



NEW



· max. 20 Bar

No.	specification			
48031	5 m	ø 9/15 mm		1
48032	10 m	ø 9/15 mm		1
48033	15 m	ø 9/15 mm		1
48034	20 m	ø 9/15 mm		1

GUN HOSE INCLUDED CONNECTORS



No.	specification	inside Ø of hose
48043	5 m 8 atm	10 mm



GUN HOSE INCLUDED CONNECTORS



No.	specification		inside Ø of hose	
48040	5 m 8 atm		8 mm	1
48041	10 m 8 atm		8 mm	1
48042	15 m 8 atm		8 mm	1

FILTER



· max. pressure 10 bar

No.	specification
48008	G 1/4'



PRESSURE REGULATOR



· working pressure 0 - 10 bar

No.	specification
48009	G 1/4'



SPARE NOZZLE



· suitable for 48021

No.	specification
48047	nozzle Ø 1,7 mm



SPARE NOZZLE



· suitable for 48022

No.	specification
48046	nozzle Ø 1,5 mm



TABLE OF WHITWORTHS PIPE THREADS

SIZE OF THREADS IN INCH	MAX. OUTER Ø OF THREADS
1/8	9,728
1/4	13,157
3/8	16,662
1/2	20,955
3/4	26,441
1	33,249

HOSE CONNECTOR WITH THREAD

ADAPTER

DOUBLE ADAPTER



No.	specification	
48075	1/4' out	10
48076	3/8' out	10
48077	1/2' out	10
48095	1/4' in	10
48096	3/8' in	10
48097	1/2' in	10

No.	specification	
48054	3/8 out x 1/4' in	10
48055	1/2' out x 3/8' in	10
48056	reduction 3/8' out x 1/2' in	10
48057	reduction 1/4' out x 3/8' in	10

No.	specification	
48050	connection 1/4' out x 1/4' out	10
48051	reduction 1/4' out x 3/8' out	10

HOSE CONNECTOR

ADAPTER WITH THREAD



No.	specification	
48070	1/4' - 6 mm	10
48071	3/8' - 9 mm	10
48072	1/2' - 13 mm	10

No.	specification	
48085	1/4' - 6 mm	10
48086	3/8' - 9 mm	10
48087	1/2' - 13 mm	10

ADAPTER WITH THREAD

ADAPTER

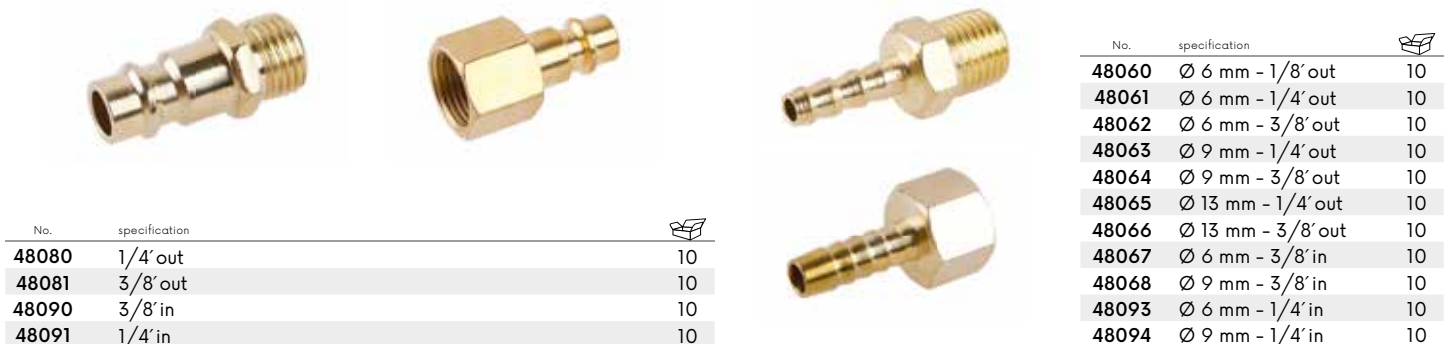

No.	specification	
48080	1/4' out	10
48081	3/8' out	10
48090	3/8' in	10
48091	1/4' in	10

No.	specification	
48060	Ø 6 mm - 1/8' out	10
48061	Ø 6 mm - 1/4' out	10
48062	Ø 6 mm - 3/8' out	10
48063	Ø 9 mm - 1/4' out	10
48064	Ø 9 mm - 3/8' out	10
48065	Ø 13 mm - 1/4' out	10
48066	Ø 13 mm - 3/8' out	10
48067	Ø 6 mm - 3/8' in	10
48068	Ø 9 mm - 3/8' in	10
48093	Ø 6 mm - 1/4' in	10
48094	Ø 9 mm - 1/4' in	10

SAFETY PRODUCTS



LASER ENHANCEMENT GLASSES

CE EN 166

Laserliner®



No.	specification	
26021	red	12

SAFETY GOOGLES

CE EN 166



No.	specification	
50510		10

SAFETY GOOGLES

CE EN 166



No.	specification	
50514		10

SAFETY GOOGLES

CE EN 166



No.	specification	
50511		12

SAFETY GOOGLES

CE EN 170



No.	specification	
50512	dark	12

SAFETY GOOGLES

CE EN 166



No.	specification	
50513		1

adjustable length of temples

PROTECTIVE HEADPHONES

CE EN 352

27 dB



No. specification
50563

1

PROTECTIVE HEADPHONES

CE EN 352

27 dB



No. specification
50564

1

SAFETY FACE SHIELD

CE EN 166



No. specification
50556

1

SAFETY HELMET CLIMAX

CE EN 397



No.	specification	
50550	blue	30
50551	red	30
50553	white	30
50554	yellow	30

PROTECTIVE SHIELD WITH GRID

CE EN 1731



No. specification
50562

1

REFLECTIVE VEST

CE EN 20471



No.	specification	
50570	orange	100
50571	yellow	100

EARPLUGS



No. specification
50560

100

EARPLUGS WITH CORD



No. specification
50559

100

RESPIRATOR

CE EN
149



No.	specification	
50500	FFP2 without valve	30
50501	FFP1 without valve	30

RESPIRATOR

CE EN
149



No.	specification	
50502	FFP1 with valve	20
50503	FFP2 with valve	20

FACE MASK

50x



No.	specification	
50505		40

MOQ
40



LEATHER GLOVES, REINFORCED

CE EN
166



· With lining in palm



No.	specification	
50518	size 11"	12

LEATHER GLOVES, REINFORCED

CE EN
388



· With lining in palm



No.	specification	
50519	size 10,5"	12

LEATHER GLOVES

CE EN
388



No.	specification	
50520	size 10,5"	12

LEATHER GLOVES

CE EN
388



No.	specification	
50521	size 10,5"	12

WINTER LEATHER GLOVES

CE EN
388



No.	specification	
50523	size 11"	12

COTTON GLOVES WITH DOTS



No.	specification	
50524	size 10"	12

COTTON GLOVE, DIPPED IN PVC

CE EN
388



No.	specification	
50525	size 10" - length 35 cm	12

POLYESTER GLOVES WITH PVC DOTS

· With PVC dots



No.	specification	
50526	size 10"	12

COTTON GLOVE, DIPPED IN LATEX

CE EN
388



No.	specification	
50522	size 10"	12

NYLON GLOVES WITH NITRILE COATING

CE EN
388



No.	specification	
50533	size 10"	12

NYLON GLOVES WITH LATEX FOAM COATING

CE EN
388



No.	specification	
50537	size 10"	12

NYLON GLOVES WITH NITRILE FOAM COATING

CE EN
388

· With PVC dots



No.	specification	
50539	size 10"	12

CRYL WINTER GLOVES WITH LATEX COATING

CE EN
388



No.	specification	
50529	size 10"	12

GLOVES FOR GARDENING



No.	specification	
50557	size 7"	12
50558	size 8"	12
50549	size 9"	12

COTON GLOVES

· With PVC dots



No.	specification	
50531	size 9"	12

GOATSKIN LEATHER GLOVES



GLOVE NYLON - PIGSKIN LEATHER



NYLON GLOVE, DIPPED IN POLYURETAN



No.	specification	
50541	size 9"	12
50542	size 10"	12

No.	specification	
50544	size 10"	12

No.	specification	
50527	size 10"	12

LEATHER GLOVES FOR WELDING



DISPOSABLE LATEX GLOVES



DISPOSABLE VINYL GLOVES



clear, powder free



No.	specification	
50540	size 11"	12

No.	specification	
50530		200

No.	specification	
50532	size 9"	100

SAFETY OVERALLS WITH HOOD



APRON FOR WELDING



No.	specification	
50585	size M	1
50586	size L	1
50587	size XL	1
50588	size XXL	1

No.	specification	
50555	leather	1

KNEELING CREEPER

KNEE PROTECTOR



No. specification  1

No. specification  8

KNEE PROTECTOR



KNEE PROTECTOR



KNEE PROTECTOR



No. specification  12

No. specification  12

No. specification  12

KNEE PROTECTOR



KNEE PROTECTOR

KNEE PROTECTOR



No. specification  20

No. specification  10

No. specification  6

BAG FOR TOOL WITH METAL HANDEL



· quality metal handle with padding

· strap with velcro to carry long tools.

· comfortable shoulder detachable strap

· reinforced internal construction

· 18 pockets

No.	high	length	deep
37331	280 mm	490 mm	230 mm



BELT



No.	specification
37328	145 cm



CASE FOR TOOL



· reinforced pockets

No.	specification
37325	



CASE FOR TOOL



· reinforced pockets

No.	specification
37326	



BAG



NEW



No.	width	high	deep
37332	480 mm	290 mm	250 mm



BAG



No.	width	high	deep
37330	610 mm	400 mm	270 mm



MOUNTING BELT



· 14 pockets + eye



No.	length	width
37311	120 cm	6 cm



CASE FOR TOOLS



• 8 pockets



No.	width	high
37320	300 mm	250 mm

CASE FOR TOOLS



• 4 pockets



No.	width	high
37321	350 mm	300 mm

CASE FOR SMALL TOOL



No.	width	high
37314	150 mm	250 mm

CASE WITH BUCKLE



No.	width	high
37312	10 mm	210 mm

CASE UNIVERSAL



No.	width	high
37313	85 mm	160 mm

NYLON BELT



No.	length	width
37310	120 cm	6 cm

WORKING JACKET



No.	specification
37350	

TOOL BELT LEATHER



No.	specification	
37302	6 pockets	50
37303	11 pockets	25

TOOL BELT LEATHER



No.	specification	
37300	6 pockets	50
37301	11 pockets	25



LEATHER BAG PROFESIONAL



No.	high	length	deep	
37342	270 mm	430 mm	180 mm	1

ELECTRICIAN LEATHER BAG



No.	high	length	deep	
37341	260 mm	430 mm	200 mm	1

LEATHER BAG WITH REINFORCED BOTTOM



No.	high	length	deep	
37340	240 mm	430 mm	150 mm	1

CRAFTMAN LEATHER BAG WITH STRAP



No.	high	length	deep	
37344	250 mm	300 mm	130 mm	1

BAG WITH REINFORCED BOTTOM



No.	high	length	deep	
37343	240 mm	430 mm	150 mm	1

ELECTRICIAN BAG



No.	high	length	deep	
37345	270 mm	430 mm	180 mm	1

TOOL BELT - LEATHER



No.	specification	
37308		20

TOOL BELT - LEATHER



No.	specification	
37309		20



136

CUTTERS KDS



138

CUTTERS FESTA



144

SCRAPERS



145

SPARE BLADES



147

KNIVES AND MACHETES



152

CUTTERS, PLIERS FOR PVC PIPES



155

POLYSTYRENE CUTTER



157

DRILLS FOR METAL



166

HOLESAW, CHISELS AND PUNCHES



170

DIAMOND HOLESAW



174

DRILLS, HOLESAWS, ROUTER BITS



178

DRILL CHUCK

DRILLS, CUTTING
AND DRILLING TOOLS

134 - 209



179

ROTATING AND GRINDING BRUSHES



183

GRINDING DISC AND PAPERS



188

RASP FOR DRYWALL



189

FILES AND RASPS



191

JIG SAW BLADES



194

SAW BLADES



197

SAWS FOR WOOD, METAL AND ETC



203

DIAMANT DISCS



206

CUTTING AND GRINDING DISCS

KDS®

Knives of Japanese company KDS

- excellent ergonomics of grips
- high performance and lifespan of blades
- blades of the best materials
- low cutting resistance enabling easy cutting



CUTTER



KDS®



No.	specification	
16002	LC405 18 mm green	25
16104	LC405 18 mm red	25

No.	specification	
16011	LB10 spare blades	10

CUTTER



KDS®

CUTTER



KDS®



No.	specification	
16003	G11 18 mm + 2 blades	10
16012	GB10 spare blades	10

No.	specification	
16019	KDS/L19 18 mm + 2 blades	10
16011	LB10 spare blades	10
16012	GB10 spare blades	10

CUTTER

KDS®



No.	specification	
16004	H11 25 mm	10
16013	HB10 spare blades	10

CUTTER

KDS®



No.	specification	
16005	S14 9 mm + 2 blades	10
16010	SB10 spare blades	10

SCALPEL

KDS®



No.	specification	
16006	D11 + 16 blades	10
16014	DB 48 spare blades	10

SPARE BLADES

KDS®



No.	specification	
16010	SB10 9 0,38 mm	13 segments 20
16011	LB10 18 0,5 mm	15 segments 20
16012	GB10 18 0,6 mm	15 segments 20
16013	HB10 25 0,7 mm	7 segments 10

SPARE BLADES

KDS®



- special alloy
- double grinding
- enhanced lifetime
- low cutting resistance
- enabling easy cutting

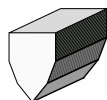

No.	specification	
16016	LB10B 18 0,5 mm	8 segments 20
16017	HB10B 25 0,7 mm	7 segments 10

STAND FOR BLADES

KDS®

• items in stand 16998

- 16001 · 5 pcs
- 16003 · 5 pcs
- 16004 · 3 pcs
- 16005 · 3 pcs
- 16006 · 2 pcs
- 16008 · 3 pcs
- 16010 · 4 pcs
- 16012 · 4 pcs
- 16013 · 1 pcs
- 16016 · 4 pcs
- 16018 · 4 pcs
- 16019 · 4 pcs
- 16020 · 4 pcs



• illustration picture

No.	specification	
16999	stand	1
16998	filled stand with items	1



FESTO

CUTTER, CERAMIC BLADE

FESTO



- 3x sharper than the steel blade
- 10x longer lifetime
- Refractory, non-conductive, non-magnetic



No.	specification	
16131	18 mm	10
16066	spare blade 18 mm, 5 pcs	10

CUTTER

FESTO



No.	specification	
16110	L11 18 mm + 1 blade	12

CUTTER

FESTO



No.	specification	
16100	L12 18 mm + 1 blade	12

CUTTER

FESTO



No.	specification	
16105	L17 18 mm + 1 blade	12

CUTTER

FESTO

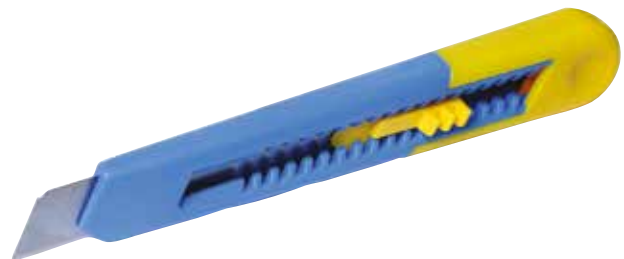

No.	specification	
16125	L4 9 mm	24
16120	L8 18 mm	24

CUTTER

FESTO



No.	specification	
16115	L10 9 mm	24

CUTTER

FESTO

ALU



No.	specification	
16150	18 mm	MOQ 24
16151	18 mm without logo FESTO	20

CUTTER **FESTA**

NEW

ALU



No. specification
16136 18 mm

1

CUTTER **FESTA**

NEW

ALU



No. specification
16137 25 mm

1

CUTTER **FESTA**

+4

ALU



· Anti-Slip rubber coating

No. specification
16090 18 mm

12

CUTTER **FESTA**

+4

ALU



· Anti-Slip rubber coating

No. specification
16091 25 mm

6

CUTTER **FESTA**

ALU



· Anti-Slip rubber coating

No. specification
16145 L25 18 mm

12

CUTTER **FESTA**

ALU



· Anti-Slip rubber coating

No. specification
16144 L24 18 mm

12

CUTTER **FESTA**

NEW

ALU



No. specification
16143 18 mm

1

CUTTER **FESTA**

NEW

ALU



No. specification
16142 18 mm

1

CUTTER

NEW

ALU



No. specification
16025 18 mm

1

CUTTER

ALU

FESTA



No. specification
16029 18 mm

25

CUTTER

FESTA



· Anti-Slip rubber coating

No. specification
16146 18 mm

12

CUTTER

FESTA



· Anti-Slip rubber coating

No. specification
16147 25 mm

12

CUTTER

+5

FESTA



· Anti-Slip rubber coating

No. specification
16130 L18 18 mm

12

CUTTER

+5

FESTA



· Anti-Slip rubber coating

No. specification
16135 L20 25 mm + 5 blades

6

CUTTER

FESTA



· Anti-Slip rubber coating

No. specification
16140 L22 18 mm

12

CUTTER

ALU

FESTA



· Anti-Slip rubber coating

No. specification
16034 25 mm

12

CUTTER



INOX



No.	specification	
16085	9 mm	24

CUTTER



INOX



No.	specification	
16086	18 mm	24

SAFETY KNIFE



self-retracting blade

No.	specification	
16057	135 mm	1

SAFETY KNIFE



ALU

INOX



16074



No.	specification	
16058		1
16074	spare blade 10 pcs	1

CUTTER



+5

ALU



No.	specification	
16037		6

FOLDING KNIFE



+5

ALU



No.	specification	
16023	folding knife	12
16071	spare blade 10 pcs	10

FOLDING KNIFE - SET

ALU



No.	specification	
16095	25 blades	1

CUTTER



ALU

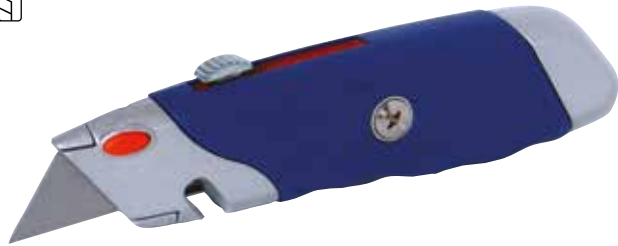

· Anti-Slip rubber coating

No. specification
16035

12

DOLPHINE CUTTER



ALU



No. specification
16033 NP 110

12

CUTTER



ALU



No. specification
16038

12

DOLPHINE CUTTER

ALU



No. specification
16032 NP 109

48

ADJUSTABLE CUTTER

ALU



No. specification
16031 NS 107 B

24

CUTTER

ALU



No. specification
16030 NS 107

24

CUTTER FOR CARPETS



· for carpet and flooring

No. specification
16036 45 mm

12

CUTTER HOOKED FOR FLOORS



· for carpet and flooring

No. specification
16041

12

CUTTER

ALU



No.	specification	
16046	18 mm	1

CUTTER



No.	specification	
16028	S 201 18 mm	24

CUTTER



No.	specification	
16026	P 205 18 mm	30

CUTTER

HOBBY



No.	specification	
16021	P 201 9 mm	60

CUTTER

HOBBY



No.	specification	
16024	P 204 18 mm	60

CUTTER



MOQ
24



· Anti-Slip rubber coating

No.	specification	
16141	18 mm	24

CUTTER SET

HOBBY

12x



No.	specification	
16053	9 mm	12
16055	18 mm	12

CUTTER SET

HOBBY

3x



No.	specification	
16043		24



WINDOW SCRAPER

NEW

ALU



50 mm



No.	specification	
16059	50 mm	1
16082	spare blade	1

WINDOW SCRAPER

NEW

ALU



100 mm



for use with 18 mm blades for cutters

No.	specification	
16054	100 mm	1

SCRAPER WITH RUBBER HANDLE

FESTA



38 mm



Anti-Slip rubber coating

No.	specification	
16049		12
16069	spare blade	1

WINDOW SCRAPER

FESTA



100 mm



No.	specification	
16052	48 cm length	6
16070	spare blade	25

WINDOW SCRAPER



60 mm



No.	specification	
16051		24

WINDOW SCRAPER



55 mm



No.	specification	
16050		24

SET OF SCRAPERS FOR APPLICATION AND REMOVING SILIKON

3x



No.	specification	
16042		12

SPARE BLADES **FESTA**

SK2

10x



- segments
- 3x longer life
- double grinding
- low cutting resistance

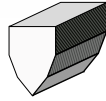

No.	specification	
16064	25 0,7 mm	1

SPARE BLADES **FESTA**

10x



- segments



No.	specification	
16068	25 0,6 mm	1

SPARE BLADES **FESTA**

SK2

10x



- segments
- 3x longer life
- double grinding
- low cutting resistance

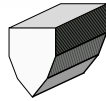

No.	specification	
16062	18 0,7 mm	1

SPARE BLADES **FESTA**

SK2

10x



- segments
- 3x longer life
- double grinding
- low cutting resistance

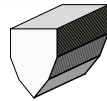

No.	specification	
16063	18 0,7 mm	1

SPARE CERAMIC BLADE **FESTA**

5x

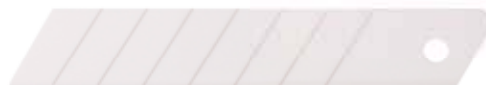

- segments
- 3x sharper than the steel blade
- 10x longer lifetime
- Refractory, non-conductive, non-magnetic



No.	specification	
16066	18 0,6 mm	10

SPARE BLADES **FESTA**

10x



- segments



No.	specification	
16067	18 0,5 mm	10

SPARE BLADES **FESTA**

10x



- segments



No.	specification	
16065	18 0,5 mm	1

SPARE BLADES **FESTA**

10x



- segments



No.	specification	
16081	18 0,5 mm	1

SPARE BLADES **FESTA**

10x



- double grinding



No.	specification	
16078	18 0,5 mm	1

SPARE BLADES **FESTA**

10x



- double grinding



No.	specification	
16077	18 0,6 mm	1

SPARE BLADES 30°

10x



SPARE BLADES

10x



· 7 segments



· 13 segments

No.	specification	
16061	9 0,4 mm	1

No.	specification	
16060	9 0,45 mm	10

SPARE BLADES



10x



SPARE BLADES



10x



SPARE BLADES



10x



· for 16058

No.	specification	
16074		1

No.	specification	
16072	R 004	10

No.	specification	
16075	R 003	10

SPARE BLADES

10x



SPARE BLADES

10x



SPARE BLADES

5x



No.	specification	
16071	R 001	60

No.	specification	
16073	R 002	60

No.	specification	
16084	18 mm	1

SPARE BLADES

5x



SPARE BLADES

5x



SPARE BLADES FOR SCRAPER

5x



No.	specification	
16083	18 mm	1

No.	specification	
34316		1

No.	specification	
16070	100 mm	25

KNIFE **FESTA**

INOX
TEFLON
NYLON

- nylon handle
- teflon coated blade
- case with fuse and clip

No.	specification	
16234	21 10 cm	1

HUNTING KNIFE **FESTA**

INOX
TEFLON

No.	specification	
16229	23 10 cm	12

MULTIFUNCTION CHISEL **FESTA**

INOX

3 mm

- thickened blade

No.	specification	
16231	20 8 cm	12

TECHNICAL KNIFE **FESTA**

INOX

- thickened blade

No.	specification	
16230	21 10 cm	12

KNIFE **FESTA**

INOX

No.	specification	
16022	16 6,5 cm	100

KNIFE FOR CARPETS AND FLOORING **FESTA**

No.	specification	
16225	20 8,5 cm	12

ELECTRICIAN KNIFE **FESTA**

INOX

- thickened blade

No.	specification	
16212	15 3,2 cm	12

STRIPPER CUTTER **FESTA**

No.	specification	
16201	Ø 8 - 27 mm	12

ELECTRICIAN KNIFE



INOX



No.	specification
16211	20 8,5 cm

10

ELECTRICIAN KNIFE



INOX



No.	specification
16210	20,5 9 cm

10

INOCULATION KNIFE



INOX



No.	specification
16219	19 11 cm

24

PLANT KNIFE



INOX



No.	specification
16218	18,5 10,5 cm

24

LOCK KNIFE



INOX



No.	specification
16220	18,5 11 cm

24

POCKET KNIFE



INOX



No.	specification
16235	17,5 8,5 cm

24

POCKET KNIFE



INOX



No.	specification
16221	21 12 cm

24

POCKET KNIFE



INOX



No.	specification
16236	22,5 11 cm

24

POCKET KNIFE



No.	specification
16209	14,5 5,5 cm



1

POCKET KNIFE



INOX



No.	specification
16222	20 12 cm



24

POCKET KNIFE



INOX

ALU



No.	specification
16223	18,5 10,5 cm



24

POCKET KNIFE MULTIFUNCTION



INOX



· 10 functions

No.	specification
16226	17,5 7 cm



24

POCKET KNIFE MULTIFUNCTION



INOX



· 5 functions

No.	specification
16228	27 10,5 cm



24

HUNTING LOCK KNIFE

· 3 functions

No.	specification
16227	20,5 10 cm



24

POCKET KNIFE MULTIFUNCTION

INOX

· 7 functions

No.	specification
16224	17,5 7 cm



24

MULTIFUNCTION PLIERS



CrV



- 9 functions
- bag

No. specification
16232

12

KNIFE FOR MINERAL WOOL



KNIFE FOR ISOLATION



No. specification
16198 44,5 | 33 cm

12

No. specification
16199 48 | 35 cm

10

MACHETE



MACHETE



TEFLON

TEFLON



No. specification
45069 440 mm

6

No. specification
44950 490 mm

4

MACHETE STAINLESS STEEL

INOX

MACHETE



No. specification
45083 430 mm
45084 600 mm

12
6

No. specification
45081 510 mm
45082 710 mm

36
36

- handle made out of ash wood

SCALPELS - SET

23x



No. specification

16282

24

SCALPELS - SET

13x



No. specification

16281

10

WHETSTONE ROUNDED



No. specification

45370 250 x 33 x 18 mm



20

WHETSTONE



No. specification

45045 150 x 50 x 30 mm



1

WHETSTONE



No. specification

45046 205 x 15 mm



100

SHARPENER FOR KNIVES AND SCISSORS



No. specification

16991



20

SHARPENER FOR KNIVES AND SCISSORS



No. specification

16990 Ø 50 mm



1

SHARPENER FOR KNIVES AND SCISSORS



No. specification

45048



20

SHARPENER FOR KNIVES AND SCISSORS 6 IN 1



No. specification

45068



10

PIPE WELDER

FESTA®



TEFLON

- voltage / frequency
- power consumption
- temperature
- extensions
- weight

230 V / 50 Hz
750 / 1500 W
0-300 C°
Ø 20,25,32,40,50,63 mm
1,6 kg



- package included: measuring tape, spirit level, screwdriver, hex key, 6x welding adapter, stand, shelf case

No.

17182



1

PIPE WELDER

FESTA®



TEFLON

- voltage / frequency
- power consumption
- temperature
- extensions
- weight

230 V / 50 Hz
800 / 1000 W
0-300 C°
Ø 16, 20, 25, 32 mm
1 kg



- package included: hex key, 4x welding adapter, stand, shelf case

No.

17183



1



FESTA®

PLIERS FOR PVC PIPE

FESTA®

Ø max.
42 mm



No. specification

17027		6
16315	spare blade	1

SPARE BLADE FOR PLIERS



• for pliers 17027

No.	specification	
16315		1

PLIERS FOR PVC PIPE

Ø max.
42 mm



No. specification

17026		6
-------	--	---

PLIERS FOR THE PROFILE

FESTA®

- Ø 16 mm
- Ø 19 mm
- Ø 25 mm
- 5x



• plinths, profiles, tubes

No.	specification	
17050		8



8

PIPE CUTTER

Ø 3-22 mm



No.	specification	
16301		10
16311	Spare blade	1



PIPE CUTTER

Ø 6-64 mm



No.	specification	
16304		6
16312	Spare blade	1



PIPE CUTTER

Ø 3-32 mm



No.	specification	
16303		10
16311	Spare blade	1

PIPE CUTTER

Ø 3-32 mm



No.	specification	
16300		10
16310	Spare blade	1

SPARE CIRCLE FOR PVC PIPE CUTTER

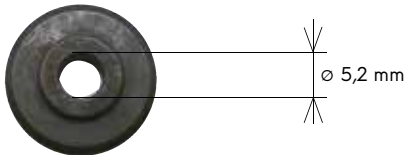

No.	specification	
16310	Ø 17,5 mm x 6 mm for 16300	1
16311	Ø 18,0 mm x 4,5 mm for 16303, 16301	1
16312	Ø 27,5 mm x 6 mm for 16304	1

PLASTIC EDGE CLEANER

Ø 6-32 mm



No.	specification	
16320		1

CLEAN CUTTER (MILLING) SET

1/4"

HSS

4x



No.	specification	
20360		10

DEBURRER



No.	specification	
20361		1

POLYSTYRENE CUTTER

FESTA®



- voltage | frequency:
- power consumption:
- length of cut
- height of cut
- protection
- angle of cut

230 V/50 Hz
160 W
137 cm
30 cm
IP44
0° - 90°

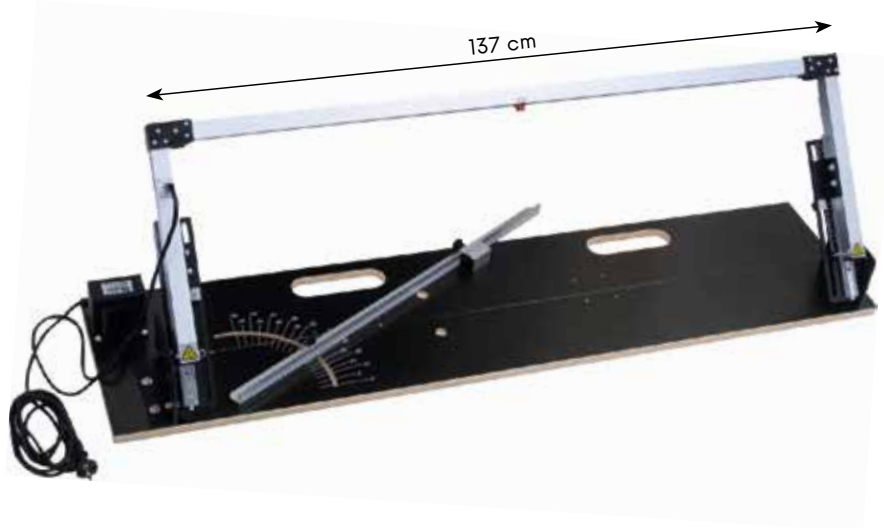
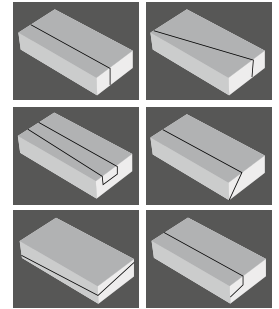

- equipment: Ni-Cr cutting wire, cleaning brass brush, inbus



No.	specification	
35345	Polystyrene cutter 1500 x 450 mm	1
35346	Spare heating string Ni-Cr	1
35347	Spare power supply	1

POLYSTYRENE CUTTER

FESTA®



- voltage | frequency:
- power consumption:
- length of cut
- height of cut
- protection
- angle of cut

230 V/50 Hz
160 W
120 cm
30 cm
IP44
0° - 90°

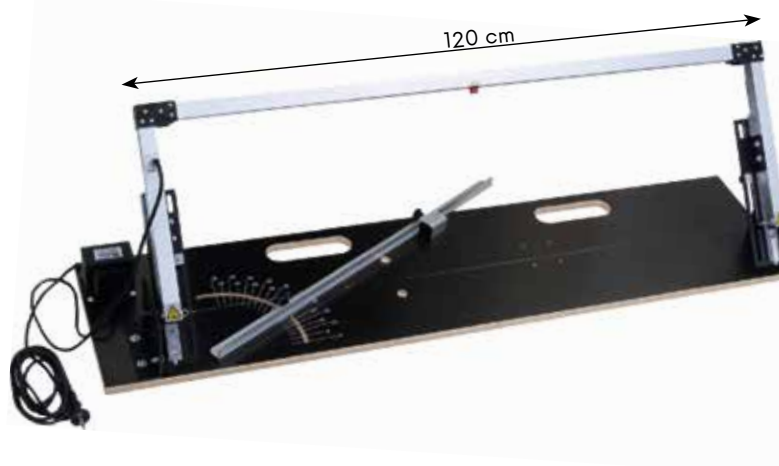
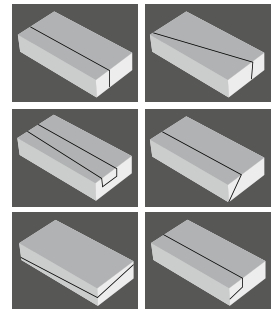

- equipment: Ni-Cr cutting wire, cleaning brass brush, inbus



No.	specification	
35330	Polystyrene cutter 1350 x 450 mm	1
35331	Spare heating string Ni-Cr	1
35347	Spare power supply	1

CORDLESS POLYSTYRENE CUTTER



- battery
- power
- temperature
- length of knife

36 V, 1,5Ah Li-ion
180 W
max 350 C°
20 cm



- equipment: 2 pcs battery, charger, blade, cleaning brass brush, inbus

No.	specification
35323	



1

ELECTRIC POLYSTYRENE CUTTER



GUIDE BAR FOR POLYSTYRENE CUTTER



- voltage / frequency
- power consumption
- temperature
- length of knife
- length of supply cable

230 V/50 Hz
250 W
50-600 C°
25 cm
3 m



- for 35323, 35326



- equipment: cleaning brass brush, inbus, blades 25 and 30 cm, case

No.	specification	
35326	electric polystyrene cutter	1
35328	Spare knife for polystyrene cutter 14 cm	1
35329	Spare knife for polystyrene cutter 25 cm	1

No.	specification	
35327	Guide bar	1
35335	Spare knife - 30 cm	1



1

POLYSTYRENE ELECTRIC CUTTER



- temperature regulation

No.	specification
35325	220 W



1

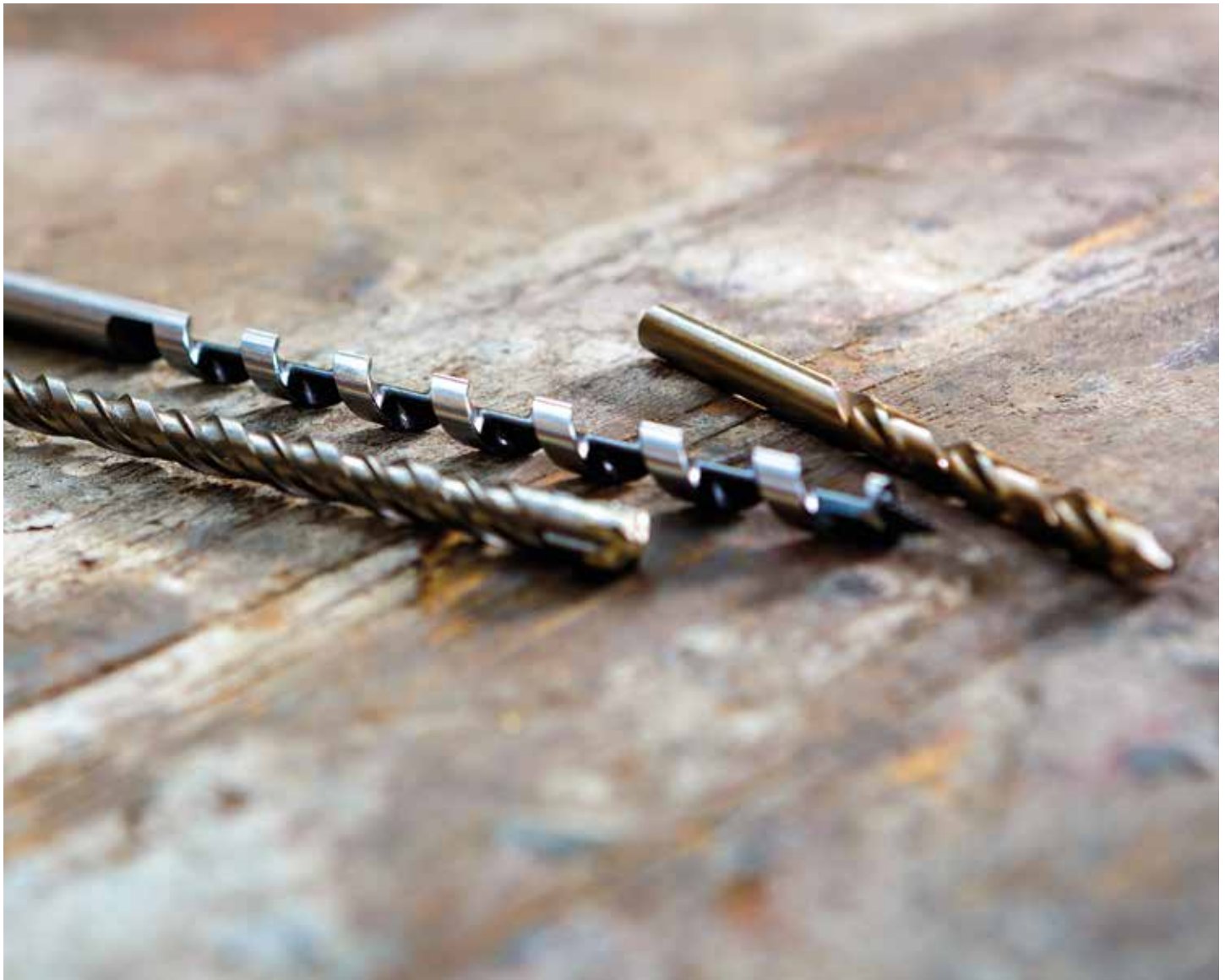

FULLY GROUND DRILL HSS-G



Co 5%, W 6%
Mo 5%, Cr 4%, V 4%

HSS



DIN
338

135°



INOX  1400 MPa



No.	specification		No.	specification		No.	specification	
22510	Ø 1,00 mm	1	22548	Ø 4,80 mm	1	22590	Ø 9,00 mm	1
22515	Ø 1,50 mm	1	22550	Ø 5,00 mm	1	22595	Ø 9,50 mm	1
22520	Ø 2,00 mm	1	22555	Ø 5,50 mm	1	22600	Ø 10,00 mm	1
22525	Ø 2,50 mm	1	22560	Ø 6,00 mm	1	22602	Ø 10,20 mm	1
22530	Ø 3,00 mm	1	22565	Ø 6,50 mm	1	22605	Ø 10,50 mm	1
22532	Ø 3,20 mm	1	22568	Ø 6,80 mm	1	22610	Ø 11,00 mm	1
22535	Ø 3,50 mm	1	22570	Ø 7,00 mm	1	22615	Ø 11,50 mm	1
22540	Ø 4,00 mm	1	22575	Ø 7,50 mm	1	22620	Ø 12,00 mm	1
22542	Ø 4,20 mm	1	22580	Ø 8,00 mm	1	22625	Ø 12,50 mm	1
22545	Ø 4,50 mm	1	22585	Ø 8,50 mm	1	22630	Ø 13,00 mm	1

FULLY GROUND DRILL HSS-G W9%



W 9%, Mo 3%
Cr 4%, V 1%

HSS

DIN 338



No.	specification		No.	specification	
19530	Ø 1,00 mm	10	19556	Ø 3,60 mm	10
19531	Ø 1,10 mm	10	19557	Ø 3,70 mm	10
19532	Ø 1,20 mm	10	19558	Ø 3,80 mm	10
19533	Ø 1,30 mm	10	19559	Ø 3,90 mm	10
19534	Ø 1,40 mm	10	19560	Ø 4,00 mm	10
19535	Ø 1,50 mm	10	19561	Ø 4,10 mm	10
19536	Ø 1,60 mm	10	19562	Ø 4,20 mm	10
19537	Ø 1,70 mm	10	19563	Ø 4,30 mm	10
19538	Ø 1,80 mm	10	19564	Ø 4,40 mm	10
19539	Ø 1,90 mm	10	19565	Ø 4,50 mm	10
19540	Ø 2,00 mm	10	19566	Ø 4,60 mm	10
19541	Ø 2,10 mm	10	19567	Ø 4,70 mm	10
19542	Ø 2,20 mm	10	19568	Ø 4,80 mm	10
19543	Ø 2,30 mm	10	19569	Ø 4,90 mm	5
19544	Ø 2,40 mm	10	19570	Ø 5,00 mm	5
19545	Ø 2,50 mm	10	19571	Ø 5,10 mm	5
19546	Ø 2,60 mm	10	19572	Ø 5,20 mm	5
19547	Ø 2,70 mm	10	19573	Ø 5,30 mm	5
19548	Ø 2,80 mm	10	19574	Ø 5,40 mm	5
19549	Ø 2,90 mm	10	19575	Ø 5,50 mm	5
19550	Ø 3,00 mm	10	19576	Ø 5,60 mm	5
19551	Ø 3,10 mm	10	19577	Ø 5,70 mm	5
19552	Ø 3,20 mm	10	19578	Ø 5,80 mm	5
19553	Ø 3,30 mm	10	19579	Ø 5,90 mm	5
19554	Ø 3,40 mm	10	19580	Ø 6,00 mm	5
19555	Ø 3,50 mm	10	19581	Ø 6,10 mm	5

No.	specification		No.	specification	
19582	Ø 6,20 mm	5	19624	Ø 10,40 mm	3
19583	Ø 6,30 mm	5	19625	Ø 10,50 mm	3
19584	Ø 6,40 mm	5	19626	Ø 10,60 mm	3
19585	Ø 6,50 mm	5	19627	Ø 10,70 mm	3
19586	Ø 6,60 mm	5	19628	Ø 10,80 mm	3
19587	Ø 6,70 mm	5	19629	Ø 10,90 mm	3
19588	Ø 6,80 mm	5	19630	Ø 11,00 mm	3
19589	Ø 6,90 mm	5	19631	Ø 11,10 mm	3
19590	Ø 7,00 mm	5	19632	Ø 11,20 mm	3
19591	Ø 7,10 mm	5	19633	Ø 11,30 mm	3
19592	Ø 7,20 mm	5	19634	Ø 11,40 mm	3
19593	Ø 7,30 mm	5	19635	Ø 11,50 mm	3
19594	Ø 7,40 mm	5	19636	Ø 11,60 mm	3
19595	Ø 7,50 mm	5	19637	Ø 11,70 mm	3
19596	Ø 7,60 mm	5	19638	Ø 11,80 mm	3
19597	Ø 7,70 mm	5	19639	Ø 11,90 mm	3
19598	Ø 7,80 mm	5	19640	Ø 12,00 mm	3
19599	Ø 7,90 mm	5	19641	Ø 12,10 mm	3
19600	Ø 8,00 mm	5	19642	Ø 12,20 mm	3
19601	Ø 8,10 mm	5	19643	Ø 12,30 mm	3
19602	Ø 8,20 mm	5	19644	Ø 12,40 mm	3
19603	Ø 8,30 mm	5	19645	Ø 12,50 mm	3
19604	Ø 8,40 mm	5	19646	Ø 12,60 mm	1
19605	Ø 8,50 mm	5	19647	Ø 12,70 mm	1
19606	Ø 8,60 mm	5	19648	Ø 12,80 mm	1
19607	Ø 8,70 mm	5	19649	Ø 12,90 mm	1
19608	Ø 8,80 mm	5	19650	Ø 13,00 mm	1
19609	Ø 8,90 mm	5	19651	Ø 13,20 mm R13	1
19610	Ø 9,00 mm	5	19652	Ø 13,50 mm R13	1
19611	Ø 9,10 mm	5	19653	Ø 14,00 mm R13	1
19612	Ø 9,20 mm	5	19654	Ø 14,50 mm R13	1
19613	Ø 9,30 mm	5	19655	Ø 15,00 mm R13	1
19614	Ø 9,40 mm	5	19656	Ø 15,50 mm R13	1
19615	Ø 9,50 mm	3	19657	Ø 16,00 mm R13	1
19616	Ø 9,60 mm	3	19658	Ø 16,50 mm R13	1
19617	Ø 9,70 mm	3	19659	Ø 17,00 mm R13	1
19618	Ø 9,80 mm	3	19660	Ø 17,50 mm R13	1
19619	Ø 9,90 mm	3	19661	Ø 18,00 mm R13	1
19620	Ø 10,00 mm	3	19662	Ø 18,50 mm R13	1
19621	Ø 10,10 mm	3	19663	Ø 19,00 mm R13	1
19622	Ø 10,20 mm	3	19664	Ø 19,50 mm R13	1
19623	Ø 10,30 mm	3	19665	Ø 20,00 mm R13	1

BOX WITH FULLY GROUND DRILLS HSS-G W 9%



W 9%, Mo 3%
Cr 4%, V 1%

HSS

DIN 338



No.	specification
19669	



No.	set content	No.	set content
19530	Ø 1,00 mm 20x	19585	Ø 6,50 mm 15x
19535	Ø 1,50 mm 20x	19590	Ø 7,00 mm 15x
19540	Ø 2,00 mm 20x	19595	Ø 7,50 mm 15x
19545	Ø 2,50 mm 20x	19600	Ø 8,00 mm 15x
19550	Ø 3,00 mm 20x	19605	Ø 8,50 mm 15x
19552	Ø 3,20 mm 20x	19610	Ø 9,00 mm 15x
19555	Ø 3,50 mm 20x	19615	Ø 9,50 mm 15x
19558	Ø 3,80 mm 20x	19620	Ø 10,00 mm 15x
19560	Ø 4,00 mm 30x	19625	Ø 10,50 mm 6x
19562	Ø 4,20 mm 20x	19630	Ø 11,00 mm 6x
19565	Ø 4,50 mm 20x	19635	Ø 11,50 mm 6x
19568	Ø 4,80 mm 20x	19640	Ø 12,00 mm 6x
19570	Ø 5,00 mm 15x	19645	Ø 12,50 mm 6x
19575	Ø 5,50 mm 15x	19650	Ø 13,00 mm 6x
19580	Ø 6,00 mm 30x		

FULLY GROUND DRILL



W 4%, Mo 3%
Cr 4%, V 1%

HSS

DIN
338



MOQ

No.	specification		No.	specification	
19670	Ø 0,6 mm	10	19694	Ø 3,1 mm	10
19671	Ø 0,8 mm	10	19695	Ø 3,2 mm	10
19672	Ø 0,9 mm	10	19696	Ø 3,3 mm	10
19673	Ø 1,0 mm	10	19697	Ø 3,4 mm	10
19674	Ø 1,1 mm	10	19698	Ø 3,5 mm	10
19675	Ø 1,2 mm	10	19699	Ø 3,6 mm	10
19676	Ø 1,3 mm	10	19700	Ø 3,7 mm	10
19677	Ø 1,4 mm	10	19701	Ø 3,8 mm	10
19678	Ø 1,5 mm	10	19702	Ø 3,9 mm	10
19679	Ø 1,6 mm	10	19703	Ø 4,0 mm	10
19680	Ø 1,7 mm	10	19704	Ø 4,1 mm	10
19681	Ø 1,8 mm	10	19705	Ø 4,2 mm	10
19682	Ø 1,9 mm	10	19706	Ø 4,3 mm	10
19683	Ø 2,0 mm	10	19707	Ø 4,4 mm	10
19684	Ø 2,1 mm	10	19708	Ø 4,5 mm	10
19685	Ø 2,2 mm	10	19709	Ø 4,6 mm	10
19686	Ø 2,3 mm	10	19710	Ø 4,7 mm	10
19687	Ø 2,4 mm	10	19711	Ø 4,8 mm	10
19688	Ø 2,5 mm	10	19712	Ø 4,9 mm	10
19689	Ø 2,6 mm	10	19713	Ø 5,0 mm	10
19690	Ø 2,7 mm	10	19714	Ø 5,1 mm	10
19691	Ø 2,8 mm	10	19715	Ø 5,2 mm	10
19692	Ø 2,9 mm	10	19716	Ø 5,3 mm	10
19693	Ø 3,0 mm	10	19717	Ø 5,4 mm	10

No.	specification		No.	specification	
19718	Ø 5,5 mm	10	19760	Ø 9,7 mm	5
19719	Ø 5,6 mm	10	19761	Ø 9,8 mm	5
19720	Ø 5,7 mm	10	19762	Ø 9,9 mm	5
19721	Ø 5,8 mm	10	19763	Ø 10,0 mm	5
19722	Ø 5,9 mm	10	19764	Ø 10,1 mm	5
19723	Ø 6,0 mm	10	19765	Ø 10,2 mm	5
19724	Ø 6,1 mm	10	19766	Ø 10,3 mm	5
19725	Ø 6,2 mm	10	19767	Ø 10,4 mm	5
19726	Ø 6,3 mm	10	19768	Ø 10,5 mm	5
19727	Ø 6,4 mm	10	19769	Ø 10,6 mm	5
19728	Ø 6,5 mm	10	19770	Ø 10,7 mm	5
19729	Ø 6,6 mm	10	19771	Ø 10,8 mm	5
19730	Ø 6,7 mm	10	19772	Ø 11,0 mm	5
19731	Ø 6,8 mm	10	19773	Ø 11,2 mm	5
19732	Ø 6,9 mm	10	19774	Ø 11,3 mm	5
19733	Ø 7,0 mm	10	19775	Ø 11,4 mm	5
19734	Ø 7,1 mm	10	19776	Ø 11,5 mm	5
19735	Ø 7,2 mm	10	19777	Ø 11,6 mm	5
19736	Ø 7,3 mm	10	19778	Ø 11,7 mm	5
19737	Ø 7,4 mm	10	19779	Ø 11,8 mm	5
19738	Ø 7,5 mm	10	19780	Ø 11,9 mm	5
19739	Ø 7,6 mm	10	19781	Ø 12,0 mm	5
19740	Ø 7,7 mm	10	19782	Ø 12,2 mm	5
19741	Ø 7,8 mm	10	19783	Ø 12,5 mm	5
19742	Ø 7,9 mm	10	19784	Ø 12,8 mm	5
19743	Ø 8,0 mm	10	19785	Ø 12,9 mm	5
19744	Ø 8,1 mm	10	19786	Ø 13,0 mm	5
19745	Ø 8,2 mm	10	19787	Ø 13,2 mm R13	5
19746	Ø 8,3 mm	10	19788	Ø 13,5 mm R13	5
19747	Ø 8,4 mm	10	19789	Ø 14,0 mm R13	5
19748	Ø 8,5 mm	10	19790	Ø 14,5 mm R13	5
19749	Ø 8,6 mm	5	19791	Ø 15,0 mm R13	5
19750	Ø 8,7 mm	5	19792	Ø 15,5 mm R13	5
19751	Ø 8,8 mm	5	19793	Ø 16,0 mm R13	5
19752	Ø 8,9 mm	5	19794	Ø 16,5 mm R13	5
19753	Ø 9,0 mm	5	19795	Ø 17,0 mm R13	5
19754	Ø 9,1 mm	5	19796	Ø 17,5 mm R13	5
19755	Ø 9,2 mm	5	19797	Ø 18,0 mm R13	5
19756	Ø 9,3 mm	5	19798	Ø 18,5 mm R13	5
19757	Ø 9,4 mm	5	19799	Ø 19,0 mm R13	5
19758	Ø 9,5 mm	5	19800	Ø 19,5 mm R13	5
19759	Ø 9,6 mm	5	19801	Ø 20,0 mm R13	5

BOX WITH FULLY GROUND DRILLS HSS 4341



W 4%, Mo 3%
Cr 4%, V 1%

HSS

DIN
338



No. specification

19802



1

No.	set content	No.	set content
19673	Ø 1,00 mm 20x	19728	Ø 6,50 mm 20x
19678	Ø 1,50 mm 20x	19733	Ø 7,00 mm 10x
19683	Ø 2,00 mm 20x	19738	Ø 7,50 mm 10x
19688	Ø 2,50 mm 20x	19743	Ø 8,00 mm 10x
19693	Ø 3,00 mm 30x	19748	Ø 8,50 mm 10x
19695	Ø 3,20 mm 30x	19753	Ø 9,00 mm 10x
19698	Ø 3,50 mm 30x	19758	Ø 9,50 mm 10x
19701	Ø 3,80 mm 30x	19763	Ø 10,00 mm 10x
19703	Ø 4,00 mm 30x	19768	Ø 10,50 mm 10x
19705	Ø 4,20 mm 30x	19772	Ø 11,00 mm 10x
19708	Ø 4,50 mm 30x	19776	Ø 11,50 mm 10x
19711	Ø 4,80 mm 30x	19781	Ø 12,00 mm 10x
19713	Ø 5,00 mm 20x	19783	Ø 12,50 mm 10x
19718	Ø 5,50 mm 20x	19786	Ø 13,00 mm 5x
19723	Ø 6,00 mm 20x		

DRILL HSS EXTENDED

W 4%, Mo 3%
Cr 4%, V 1%

HSS

DIN 338



No.	specification		No.	specification	
20220	Ø 2,0 mm x 85 mm	10	20255	Ø 5,5 mm x 139 mm	10
20225	Ø 2,5 mm x 95 mm	10	20260	Ø 6,0 mm x 139 mm	10
20230	Ø 3,0 mm x 100 mm	10	20270	Ø 7,0 mm x 156 mm	10
20235	Ø 3,5 mm x 110 mm	10	20280	Ø 8,0 mm x 165 mm	10
20240	Ø 4,0 mm x 119 mm	10	20290	Ø 9,0 mm x 175 mm	10
20245	Ø 4,5 mm x 126 mm	10	20296	Ø 10,0 mm x 184 mm	10
20250	Ø 5,0 mm x 132 mm	10			

TITANIUM DRILL HSS TIN

TiN

HSS

DIN 338



titanium surface to enhance performance and durability

No.	specification		No.	specification		No.	specification	
20400	Ø 1,0 mm	1	20411	Ø 4,8 mm	1	20422	Ø 9,5 mm	1
20401	Ø 1,5 mm	1	20412	Ø 5,0 mm	1	20423	Ø 10,0 mm	1
20402	Ø 2,0 mm	1	20413	Ø 5,5 mm	1	20424	Ø 10,2 mm	1
20403	Ø 2,5 mm	1	20414	Ø 6,0 mm	1	20425	Ø 10,5 mm	1
20404	Ø 3,0 mm	1	20415	Ø 6,5 mm	1	20426	Ø 11,0 mm	1
20405	Ø 3,2 mm	1	20416	Ø 6,8 mm	1	20427	Ø 11,5 mm	1
20406	Ø 3,5 mm	1	20417	Ø 7,0 mm	1	20428	Ø 12,0 mm	1
20407	Ø 3,8 mm	1	20418	Ø 7,5 mm	1	20429	Ø 12,5 mm	1
20408	Ø 4,0 mm	1	20419	Ø 8,0 mm	1	20430	Ø 13,0 mm	1
20409	Ø 4,2 mm	1	20420	Ø 8,5 mm	1			
20410	Ø 4,5 mm	1	20421	Ø 9,0 mm	1			

DRILL HSS

HSS

DIN 338



No.	specification	
19841	Ø 4,1 mm 5 pcs	10
19842	Ø 4,2 mm 5 pcs	10
19845	Ø 4,5 mm 5 pcs	10
19885	Ø 8,5 mm 1 pcs	10
19895	Ø 9,5 mm 1 pcs	10

FULLY GROUND DRILL SET HSS

W 9%, Mo 3%
Cr 4%, V 1%

FESTA

HSS

DIN
338

13x



No. specification
20333 Ø 1,5 - 6,5 mm

FULLY GROUND DRILL SET HSS

W 9%, Mo 3%
Cr 4%, V 1%

FESTA

HSS

DIN
338

19x



No. specification
20334 Ø 1,0 - 10,0 mm

FULLY GROUND DRILL SET HSS

W 9%, Mo 3%
Cr 4%, V 1%

FESTA

HSS

DIN
338

25x



No. specification
20335 Ø 1,0 - 13,0 mm

DRILL SET

FESTA

W 4%, Mo 3%
Cr 4%, V 1%

HSS

DIN
338

13x



No. specification
20336 Ø 1,5 - 6,5 mm

DRILL SET

FESTA

W 4%, Mo 3%
Cr 4%, V 1%

HSS

DIN
338

19x



No. specification
20337 Ø 1,0 - 10,0 mm

DRILL SET

FESTA

W 4%, Mo 3%
Cr 4%, V 1%

HSS

DIN
338

25x



No. specification
20338 Ø 1,0 - 13,0 mm

DRILL SET

TiN

9x



No. specification
20317 Ø 5, 6, 8 mm

FESTA

DRILL SET - WITH HEXAGON STALK

FESTA

1/4"

HSS

7x



No. specification
20316 Ø 1,5-2-3-4-5-5,5-6 mm



DRILL SET

HSS

DIN 338

19x



DRILL SET

HSS

DIN 338

25x



No. specification
20305 Ø 1,0 - 10,0 mm



No. specification
20311 Ø 1,0 - 13,0 mm



DRILL SET

HSS

DIN 338

13x



No. specification
20300 Ø 1,5 - 6,5 mm



DRILL SET

HSS

DIN 338

19x



No. specification
20310 Ø 1 - 13 mm



DRILL SET

HSS

DIN 338

19x



No. specification
20315 Ø 1 - 10 mm



DRILL SET

TiN

HSS

DIN 338

19x



No. specification
20320 Ø 1 - 10 x 0,5 mm



DRILL SET

HSS

DIN 338

19x



No. specification
20321 Ø 1 - 10 x 0,5 mm



DRILL SHARPENER



No. specification
20380 for Ø 3,5 - 10 mm



STEP DRILL TIN

FESTA

TiN

HSS



No.	specification	
20489	Ø 4 - 12 mm 8 steps	20
20490	Ø 4 - 20 mm 9 steps	10
20491	Ø 5 - 35 mm 13 steps	10
20492	Ø 7 - 40,5 mm 13 steps	5

STEP DRILL HSS

HSS



No.	specification	
20487	Ø 4 - 20 mm 9 steps	10
20488	Ø 5 - 35 mm 13 steps	10
20494	Ø 4 - 32 mm 15 steps	10
20493	Ø 7 - 40,5 mm 13 steps	1

STEP DRILL SET TiN

FESTA

TiN

HSS

3x



No.	specification	
20495	Ø 4 - 12, 4 - 20, 4 - 32 mm	1

STEP DRILL SET

HSS

3x

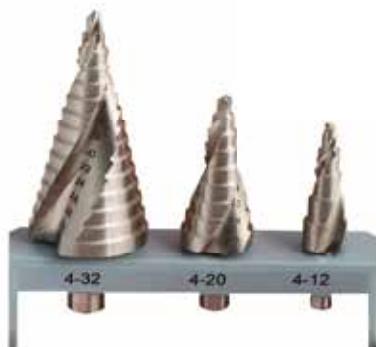

No.	specification	
20496	Ø 4 - 12, 4 - 20, 4 - 32 mm	1

HOLESAW HSS BI-METAL



NEW

HSS



No.	specification	
24419	Ø 19 mm	1
24420	Ø 20 mm	1
24422	Ø 22 mm	1
24425	Ø 25 mm	1
24429	Ø 29 mm	1
24432	Ø 32 mm	1
24435	Ø 35 mm	1
24437	Ø 37 mm	1
24444	Ø 44 mm	1
24451	Ø 51 mm	1
24457	Ø 57 mm	1
24464	Ø 64 mm	1
24476	Ø 76 mm	1
24483	Ø 83 mm	1



HOLESAW HOLDER



NEW

14 - 30 mm



HOLESAW HOLDER



NEW

32 - 152 mm



No.	specification	
24410		1

No.	specification	
24411		1

DRILLS HSS, HOLESAW BI-METAL - SET



HSS

9x



DRILLS HSS, HOLESAW BI-METAL - SET



HSS

13x



No.	specification	
24750	Ø 19, 22, 29, 38, 44, 57 mm	10

No.	specification	
24751	Ø 19, 22, 29, 35, 38, 44, 51, 57, 64 mm	10

SCREW EXTRACTORS

8x

FESTA

- Ø 4 mm
- Ø 4,5 mm
- Ø 6,5 mm
- Ø 7,5 mm
- Ø 11 mm
- Ø 15 mm
- Ø 19 mm
- Ø 24 mm



No. specification
20387

5

SCREW EXTRACTORS

5x

FESTA

- Ø 4 mm
- Ø 4,5 mm
- Ø 6 mm
- Ø 7,5 mm
- Ø 11 mm



No. specification
20386

10

SCREW EXTRACTORS

5x

- Ø 4 mm
- Ø 4,5 mm
- Ø 6 mm
- Ø 7,5 mm
- Ø 11 mm



No. specification
20385

10

DIE WRENCH

DIN
225



No. specification
20396 25 x 9 mm

10

FESTA

TAPS RATCHET



TAP WRENCH

DIN
1814



No. specification
20395 1 - 1/2, M3 - M12

10

No. specification
20397 M3 - M8

10

TAPS AND DIES SET

32x

FESTA



No. specification
20391 M 3, 4, 5, 6, 8, 10, 12 mm

1

TAPS SET

21x

FESTA



No. specification
20390 M 3, 4, 5, 6, 8, 10, 12 mm

1

MASONRY DRILL



DIN 8039

• two drilling bit

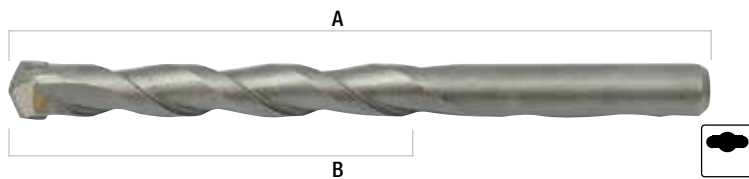

No.	diameter	A mm	B mm	
20673	Ø 3 mm	60	30	100
20674	Ø 4 mm	75	40	100
20675	Ø 5 mm	85	50	100
20676	Ø 6 mm	100	60	100
20677	Ø 6 mm	200	160	50
20685	Ø 6 mm	300	260	50

No.	specification	A mm	B mm	
20678	Ø 8 mm	120	75	50
20686	Ø 8 mm	200	155	50
20687	Ø 8 mm	300	255	25
20688	Ø 8 mm	400	340	25
20680	Ø 10 mm	120	70	50
20690	Ø 10 mm	200	150	50
20691	Ø 10 mm	300	250	25
20692	Ø 10 mm	400	340	25
20682	Ø 12 mm	150	100	50
20694	Ø 12 mm	300	250	25
20696	Ø 12 mm	400	340	25
20684	Ø 14 mm	150	90	25
	reduction Ø 10 mm			
20697	Ø 14 mm	300	240	5
	reduction Ø 10 mm			
20698	Ø 14 mm	400	340	15
	reduction Ø 10 mm			

MASONRY DRILL SDS+



SDS+

• two drilling bit

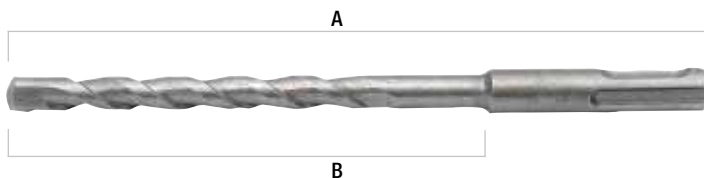

No.	specification	A mm	B mm	
20855	Ø 14 mm	160	75	25

MASONRY DRILL SDS+



SDS+

• four drilling bit with increment of feat and lifetime

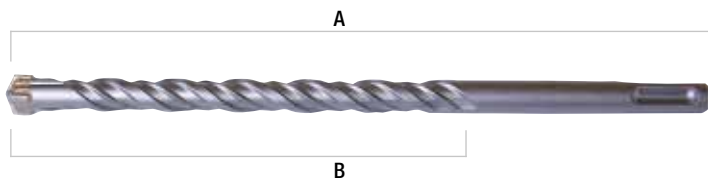

No.	specification	A mm	B mm	
20748	Ø 6 mm	110	40	50
20749	Ø 6 mm	160	90	50
20750	Ø 6 mm	210	140	50
20751	Ø 6 mm	260	190	50
20861	Ø 6,5 mm	230	160	50
20862	Ø 6,5 mm	300	230	50
20752	Ø 8 mm	110	40	50
20753	Ø 8 mm	160	90	50
20754	Ø 8 mm	210	140	50
20755	Ø 8 mm	260	190	50
20825	Ø 8 mm	350	280	50
20756	Ø 10 mm	160	90	50
20757	Ø 10 mm	210	140	50
20758	Ø 10 mm	260	190	50
20759	Ø 10 mm	350	280	50
20760	Ø 10 mm	450	380	50

No.	specification	A mm	B mm	
20761	Ø 10 mm	600	530	50
20762	Ø 10 mm	1000	930	50
20764	Ø 12 mm	160	80	50
20765	Ø 12 mm	210	130	50
20766	Ø 12 mm	260	180	50
20767	Ø 12 mm	350	270	50
20768	Ø 12 mm	460	380	50
20769	Ø 12 mm	600	520	25
20770	Ø 12 mm	1000	920	25
20771	Ø 14 mm	160	80	25
20772	Ø 14 mm	260	180	25
20773	Ø 14 mm	350	270	25
20774	Ø 14 mm	460	380	25
20775	Ø 14 mm	600	520	25
20776	Ø 14 mm	1000	920	30
20777	Ø 16 mm	160	80	25

No.	specification	A mm	B mm	
20778	Ø 16 mm	210	130	25
20779	Ø 16 mm	260	180	25
20780	Ø 16 mm	350	270	25
20781	Ø 16 mm	460	380	25
20782	Ø 16 mm	600	520	30
20783	Ø 16 mm	1000	920	25
20784	Ø 18 mm	260	180	25
20785	Ø 18 mm	450	370	25
20786	Ø 18 mm	600	520	32
20787	Ø 18 mm	1000	920	20
20788	Ø 20 mm	450	370	20
20789	Ø 20 mm	600	520	20
20790	Ø 20 mm	800	720	25
20791	Ø 20 mm	1000	920	10
20792	Ø 22 mm	450	365	20
20793	Ø 22 mm	600	520	20
20794	Ø 22 mm	800	715	20
20795	Ø 22 mm	1000	920	10
20796	Ø 24 mm	450	365	10
20797	Ø 24 mm	600	520	20
20798	Ø 24 mm	800	715	10
20799	Ø 24 mm	1000	920	10
20870	Ø 26 mm	450	370	10
20871	Ø 26 mm	650	570	20
20872	Ø 26 mm	800	720	10
20873	Ø 26 mm	1000	920	10
20874	Ø 28 mm	450	365	10
20875	Ø 28 mm	600	565	20
20876	Ø 28 mm	800	715	10
20877	Ø 28 mm	1000	915	10
20878	Ø 30 mm	450	365	10
20879	Ø 30 mm	600	565	20
20880	Ø 30 mm	800	715	10
20881	Ø 30 mm	1000	915	10

MASONRY DRILL SDS MAX

FESTA



SDS MAX

· four drilling bit with increment of feat and lifetime

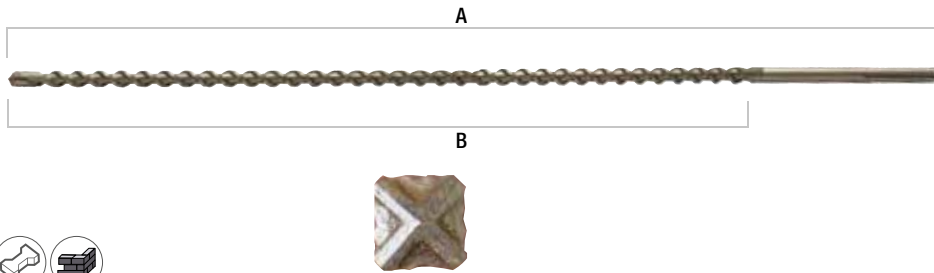

No.	specification	A mm	B mm	
20510	Ø 18 mm	550	395	5
20520	Ø 18 mm	800	650	5
20511	Ø 20 mm	550	395	5
20521	Ø 20 mm	800	650	5
20512	Ø 22 mm	550	395	5
20522	Ø 22 mm	800	650	5
20513	Ø 24 mm	550	395	5
20523	Ø 24 mm	800	650	5
20514	Ø 28 mm	550	395	5
20524	Ø 28 mm	800	650	5
20515	Ø 30 mm	550	395	5
20525	Ø 30 mm	800	650	5
20516	Ø 40 mm	550	395	2
20526	Ø 40 mm	800	650	1



MASONRY DRILL SET SDS+

SDS+

5x



No.	specification	
20890	Ø 5, 6, 8, 10, 12 mm 160 mm	25

MASONRY DRILL SET SDS+

SDS+

6x



No.	specification	
20891	Ø 5, 6, 8 mm 110 mm Ø 8, 10, 12 mm 160 mm	25

ADVERTISING STAND



No.	specification	
20999		1

MASONRY DRILL SET

DIN 8039

6x



No.	specification	
20895	Ø 5, 6, 8, 10, 12 mm	25

MASONRY DRILL AND CHISEL SET SDS+

SDS+

17x



· gad
· chisel
· drill Ø 5-12 mm

No.	specification	
20952		1

MASONRY DRILL SET



No.	specification	
20805	5 pcs Ø 4 - 10 mm	10
20820	8 pcs Ø 3 - 10 mm	10

MASONRY DRILL AND CHISEL SET SDS+

SDS+

12x



· chisel 250 mm
· chisel hollow 22 x 250 mm
· flat 20 x 250 mm

No.	specification	
20950		6

FESTA

Ø 5 x 110 mm
Ø 6 x 110 mm
Ø 8 x 160 mm
Ø 10 x 160 mm
Ø 12 x 160 mm
Ø 14 x 210 mm
Ø 16 x 210 mm
Ø 18 x 310 mm
Ø 20 x 450 mm

CHISEL SET



SDS+

4x



No.	specification	
20954		1

FLAT CHISEL, 15° ANGLE



SDS+

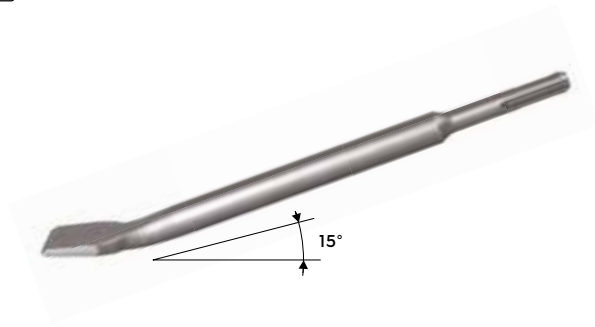

No.	specification	
20936	40 x 250 mm	5

CHISEL



SDS MAX



No.	specification	
20940	25 x 280 mm	5
20941	40 x 280 mm	5
20942	75 x 280 mm	5
20943	25 x 400 mm	5
20944	40 x 400 mm	5
20945	25 x 600 mm	5
20946	50 x 600 mm	5

FLAT CHISEL



SDS+



No.	specification	
20948	20 x 250 mm	25
20990	20 x 400 mm	25
20949	40 x 250 mm	25
20991	40 x 400 mm	25

HAMMER CHISEL



SDS MAX



No.	specification	
20937	∅ 18 x 280 mm	5
20938	∅ 18 x 400 mm	5
20939	∅ 18 x 600 mm	2

HAMMER CHISEL



SDS+



No.	specification	
20947	250 mm	25
20992	400 mm	25

CLAMPING CLIP FOR DRILL BITS



SDS MAX



No.	specification	
24730	180 mm	1

CHISEL



SDS+



No.	specification	
20956	22 x 250 mm	25

CLAMPING CLIP FOR DRILL BITS



SDS+



No.	specification	
24731	300 mm	1
24732		1

ADAPTER SDS MAX TO SDS +

SDS MAX

→ SDS+



No.	specification	
20744		1

MASONRY HOLESAW WITH TC TOOTH

SDS+

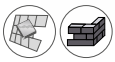

clamping clip for drill bits 24730, 24731 a 24732

No.	specification	
24719	Ø 67 mm	1
24717	Ø 73 mm	1
24723	Ø 80 mm	1
24718	Ø 100 mm	1
24757	NEW Ø 115 mm	1
24758	NEW Ø 125 mm	1
24759	NEW Ø 150 mm	1



HOLESAW



No.	specification	
24725	Ø 20-95mm	10

HOLESAW WITH COVER



No.	specification	
24726	Ø 20-95mm	1



HOLESAW SET

8x



No.	specification	
24747	Ø 33, 53, 67, 73, 83 mm driving peg, drill, file	1

HOLESAW SET FOR TILES

6x



No.	specification	
24745	Ø 33, 53, 67, 73 mm + driving peg, drill	1



HOLESAW



HOLESAW SET FOR TILES



3x



No.	specification	
24735	Ø 33 mm	1
24736	Ø 43 mm	1
24737	Ø 53 mm	1
24738	Ø 67 mm	1
24739	Ø 73 mm	1
24740	Ø 83 mm	1
24741	Ø 103 mm	1

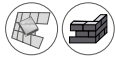

No.	specification	
24746	Ø 103 mm + driving peg, drill	1



DRIVING PEG FOR HOLESAW



DRILL FOR HOLESAW



No.	specification	
24748	Ø 33 - 83 mm	10
24743	Ø 33 - 103 mm	10



No.	specification	
24749		50



FILE FOR TILES, ROUND



FILE FOR TILES, FLAT



· for grinding bricks before inserting a wall anchor



No.	specification	
22200	200 mm	20



No.	specification	
22201	200 mm double asperity	20



DIAMOND HOLESAW



DRILLING AND BORING CROW LEADER



· for glass and ceramics drilling
· cooling required

No.	specification	
24770	Ø 4 mm	1
24771	Ø 6 mm	1
24772	Ø 8 mm	1
24773	Ø 10 mm	1
24774	Ø 12 mm	1



No.	specification	
20379	Ø 4, 5, 6, 7, 8, 10, 12 mm	10



DIAMOND HOLESAW

FESTA

M14



no need to cool with water

sample video



• ceramic tiles
• marble
• granite



No.	specification		No.	specification	
24760	Ø 6 mm M14	1	24767	Ø 45 mm M14	1
24761	Ø 8 mm M14	1	24791	Ø 50 mm M14	1
24762	Ø 10 mm M14	1	24768	Ø 53 mm M14	1
24763	Ø 12 mm M14	1	24792	Ø 60 mm M14	1
24764	Ø 14 mm M14	1	24793	Ø 65 mm M14	1
24790	Ø 20 mm M14	1	24769	Ø 68 mm M14	1
24765	Ø 28 mm M14	1	24794	Ø 75 mm M14	1
24766	Ø 35 mm M14	1	24796	Ø 83 mm NEW M14	1

DIAMOND HOLESAW

FESTA

NEW



• ceramic tiles
• marble
• granite

No.	specification	
24700	Ø 6 mm	1
24701	Ø 8 mm	1
24702	Ø 10 mm	1
24703	Ø 12 mm	1
24704	Ø 14 mm	1
24705	Ø 20 mm	1

DIAMOND HOLESAW - SET

FESTA

NEW

6x



• ceramic tiles
• marble
• granite



No.	specification	
24798	Ø 6, 8, 10, 12, 14, 20 mm	1

DIAMOND GRINDING DRUM

FESTA

M14



no need to cool with water



• ceramic tiles
• marble
• granite

No.	specification	
24795	Ø 20 x 50 mm	1

DRILL FOR GLASS AND CERAMICS

FESTA

TiN

1/4"



No.	specification	
24780	Ø 4 mm	10
24781	Ø 5 mm	40
24782	Ø 6 mm	40
24783	Ø 8 mm	40
24784	Ø 10 mm	40
24785	Ø 12 mm	40
24786	NEW Ø 14 mm	1
24787	NEW Ø 16 mm	1
24788	NEW Ø 18 mm	1
24789	NEW Ø 20 mm	1

SET OF PUNCHES AND CHISELS



SET OF CHISELS



CrV

12x

CrV

6x



- 2, 6, 8 mm
- 10, 12, 16 mm
- Ø 1,5-3-4-5-6-8 mm



- 2 x 140, 8 x 115 mm
- 12 x 152, 10 x 142 mm
- Ø 3 x 152, 6 x 152 mm



No. specification

19487

No. specification

4

No. specification

19486

No. specification

10

SET OF CHISELS



POINT CHISEL



CrV

3x

CrV



- 10, 12, 16 mm



No. specification

19485

No. specification

10

No. specification

19429

200 mm

No. specification

1

FLAT CHISEL



FLAT CHISEL

CrV

CrV



No. specification

19410	200 mm	20 mm	10
19411	250 mm	25 mm	10
19412	300 mm	25 mm	10
19418	400 mm	25 mm	5
19419	500 mm	25 mm	5

No. specification

19436	200 mm	20 mm	15
-------	--------	-------	----

SET OF PUNCHES



CrV

6x



No.	specification	
19483	Ø 3, 4, 5, 6, 7, 8 mm	5

PUNCH SET



CrV

6x



No.	specification	
19482	Ø 3, 4, 5, 6, 8 mm	5

PUNCH



CrV



No.	specification	
19472	Ø 4 mm 150 mm	1
19473	Ø 5 mm 150 mm	1
19474	Ø 6 mm 150 mm	1

SET OF PUNCHES



CrV

3x



No.	specification	
19480	Ø 0.8, 1.5, 2.5 mm	10

CENTRE PUNCH



CrV



No.	specification	
19477	Ø 2,5 mm	20

CENTRE PUNCH SET



CrV

3x



No.	specification	
19481	Ø 0.8, 1.5, 2.5 mm	10

CENTRE PUNCH AUTOMATIC



CrV



No.	specification	
19478	Ø 2,5 mm	20

GLASS CUTTER



No.	specification	
20350	130 mm	12

AUGER BIT



No.	specification		No.	specification	
20980	Ø 6 x 230 mm	1	20984	Ø 16 x 230 mm	1
20957	Ø 6 x 300 mm	1	20899	Ø 16 x 300 mm	1
20981	Ø 8 x 230 mm	1	20917	Ø 16 x 450 mm	1
20958	Ø 8 x 300 mm	1	20922	Ø 16 x 600 mm	1
20982	Ø 10 x 230 mm	1	20918	Ø 18 x 450 mm	1
20896	Ø 10 x 300 mm	1	20923	Ø 18 x 600 mm	1
20913	Ø 10 x 450 mm	1	20919	Ø 20 x 450 mm	1
20983	Ø 12 x 230 mm	1	20924	Ø 20 x 600 mm	1
20897	Ø 12 x 300 mm	1	20724	Ø 22 x 450 mm	1
20915	Ø 12 x 450 mm	1	20725	Ø 24 x 450 mm	1
20920	Ø 12 x 600 mm	1	20726	Ø 26 x 450 mm	1
20898	Ø 14 x 300 mm	1	20727	Ø 28 x 450 mm	1
20916	Ø 14 x 450 mm	1	20728	Ø 30 x 450 mm	1
20921	Ø 14 x 600 mm	1			



AUGER BIT SET



5x



No.	specification	
20911	Ø 8, 10, 12, 14, 16 x 460 mm	10

AUGER BIT SET



6x



No.	specification	
20912	Ø 6, 8, 10, 12, 16, 20 x 230 mm	10

DRILL FOR WOOD



No.	specification		No.	specification		No.	specification	
20729	Ø 6 x 400 mm	1	20732	Ø 12 x 400 mm	1	20734	Ø 16 x 400 mm	1
20731	Ø 8 x 400 mm	1	20738	Ø 12 x 600 mm	1	20740	Ø 16 x 600 mm	1
20736	Ø 8 x 600 mm	1	20733	Ø 14 x 400 mm	1	20735	Ø 18 x 400 mm	1
20730	Ø 10 x 400 mm	1	20739	Ø 14 x 600 mm	1	20741	Ø 18 x 600 mm	1
20737	Ø 10 x 600 mm	1						

DRILL - WOOD



No.	specification	
21440	Ø 4 x 75 mm	1
21441	Ø 5 x 85 mm	1
21442	Ø 6 x 90 mm	1
21443	Ø 7 x 105 mm	1
21444	Ø 8 x 115 mm	1
21445	Ø 9 x 120 mm	1
21446	Ø 10 x 120 mm	1

WOOD DRILL SET



No.	specification	
20910	8 pcs Ø 3, 4, 5, 6, 7, 8, 9, 10 mm	10
20905	5 pcs Ø 4, 5, 6, 8, 10 mm	10

SAW DRILL

HSS

TiN



No. specification
20460 Ø 6 mm

50

SAW DRILL SET

HSS

TiN

6x

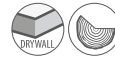

No. specification
20450 Ø 3, 4, 5, 6, 6.5, 8 mm

1

FULLY GROUND DRILL

FESTA

HSS

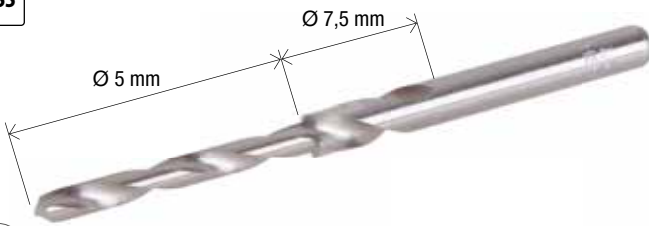

No. specification
20210 Ø 7.5, 5 mm

1

FORSTNER BIT SET

5x

FLAT WOODEN DRILL SET

6x



No. specification
20901 Ø 10, 12, 16, 18, 20, 25 mm

20



No. specification
21530 Ø 15, 20, 25, 35 mm Ø 8 mm

1

ROUTER BIT SET

5x

ROUTER BIT SET

12x

ROUTER BIT SET

24x



No. specification
21450 Ø 8 mm

1

No. specification
21451 Ø 8 mm

1



No. specification
21452 Ø 8 mm

1



1

ROUTER BIT SET

35x



No. 21453 specification Ø 8 mm



1

ROUTER BIT SET

59x



No. 21454 specification Ø 8 mm



1

ROTARY RASP SET

5x



No. 21541 specification



25

MOUNDED STONE SET

5x



No. 21540 specification Ø 3 mm, 6 mm



25

GRINDING ACCESSORIES

100x



No. 24755 specification

5

GRINDING ACCESSORIES

150x



No. 24756 specification

1

HOLESAW SET



HOLESAW



12x

- Ø 19 mm
- Ø 22 mm
- Ø 25,5 mm
- Ø 36 mm
- Ø 44 mm
- Ø 51 mm
- Ø 60 mm
- Ø 67 mm
- Ø 76 mm
- Ø 82 mm
- hex key
- 2x head

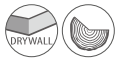

No.	specification
24712	6 tpi



20

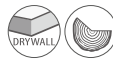

No.	specification	
24715	1' Ø 67 mm 6 tpi	5
24713	1' Ø 73 mm 6 tpi	5
24714	1' Ø 102 mm 6 tpi	5
24720	1' Ø 152 mm 6 tpi	5

HOLESAW SET



HOLESAW SET

8x

- Ø 64 mm
- Ø 73 mm
- Ø 89 mm
- Ø 102 mm
- Ø 127 mm
- hex key
- head

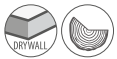

No.	specification
24706	6 tpi

20



No.	specification	
24721	1' Ø 26, 32, 38, 45, 50, 56, 63 mm	10
24722	2' Ø 26, 32, 38, 45, 50, 56, 63 mm	10

ADJUSTABLE HOLESAW DRILL

GIMLET SET - SET

4x

HOBBY

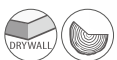

No.	specification
24716	Ø 30 - 120 mm



5

No.	specification	
20381	Ø 2, 3, 4, 5 mm	20

ADAPTER SDS MAX NA SDS +



No.	specification	
20744		1

ADAPTER SDS+



No.	specification	
20745		1

CHUCK DRILL



No.	specification	
20960	1-13 mm + 2 keys, 1/2 - 20 UNF	1
20966	spare key	30

DRILL CHUCK QUICKGRIP



No.	specification	
20965	1,5 - 13 mm 1/2' - 20 UNF	1

DRILL CHUCK QUICKGRIP



No.	specification	
20961	1,5 - 13 mm 1/2' - 20 UNF	1

ADAPTER FOR DRILLING 90°



No.	specification	
20365	Ø 1,5 - 10 mm	10

DRILL CHUCK QUICKGRIP FOR AKU



No.	specification	
20963	Ø 1 - 6 mm	10

NUMBER PUNCH



No.	specification	
20972	6 mm	5
20973	8 mm	5

PUNCH SET



No.	specification	
24695	Ø 5, 6, 8, 10, 11, 13, 16, 19, 22, 25, 28, 32, 35 mm	5

PUNCH SET

- 24690 - Ø 2,5 mm
- Ø 3 mm
- Ø 4 mm
- Ø 5 mm
- Ø 6 mm
- Ø 7 mm
- Ø 8 mm
- Ø 9 mm
- Ø 10 mm
- 24691 - Ø 2mm
- Ø 2,5 mm
- Ø 3,2 mm
- Ø 4 mm
- Ø 4,8 mm
- Ø 5 mm
- Ø 6,4 mm
- Ø 8 mm
- Ø 9,5 mm
- Ø 11,1 mm
- Ø 12,7 mm
- Ø 14 mm
- Ø 15,8 mm
- Ø 19 mm
- Ø 22 mm



No.	specification	
24690	9 pcs Ø 2,5 - 10 mm	10
24691	15 pcs Ø 2 - 22 mm	5

LETTER PUNCH



No.	specification	
20970	6 mm	5
20971	8 mm	5

FESTA[®]



BEVEL BRUSH, BRASS COATED

M14

FESTA

BEVEL BRUSH, BRASS COATED

M14

FESTA

BEVEL BRUSH, BRASS

M14

FESTA



20mm



· brass coated

No.	specification	M14	wire	
21900	Ø 100 mm	M14	s 0,3	60
21902	Ø 125 mm	M14	s 0,3	42



10mm



· brass coated

No.	specification	M14	wire	
22001	Ø 100 mm	M14	s 0,3	60
21901	Ø 125 mm	M14	s 0,3	42



· brass



No.	specification	M14	wire	
21920	Ø 100 mm	M14	s 0,3	60

CUP BRUSH, BRASS COATED

M14

FESTA

CUP BRUSH, BRASS

M14

FESTA

RADIAL BRUSH, BRASS COATED

· reduction rings

FESTA



· brass coated



No.	specification	M14	wire	
21903	Ø 65 mm	M14	s 0,3	60
22002	Ø 75 mm	M14	s 0,3	80
21904	Ø 85 mm	M14	s 0,3	60
22003	Ø 100 mm	M14	s 0,3	36
21905	Ø 125 mm	M14	s 0,3	24
21906	Ø 150 mm	M14	s 0,3	12



· brass



No.	specification	M14	wire	
21925	Ø 75 mm	M14	0,3 mm	80
21926	Ø 100 mm	M14	0,3 mm	36



· brass coated



No.	specification	M14	wire	
22007	Ø 100 mm Ø 20 mm	M14	s 0,3	60
22008	Ø 125 mm Ø 20 mm	M14	s 0,3	42
22009	Ø 150 mm Ø 32,2 mm	M14	s 0,3	32
22010	Ø 175 mm Ø 32,2 mm	M14	s 0,3	20
22011	Ø 200 mm Ø 32,2 mm	M14	s 0,3	20

CUP BRUSH, KNOTTED



M14



· hardened



No.	specification	wire	
22004	Ø 65 mm M14	s 0,3	60
22005	Ø 75 mm M14	s 0,3	24
22006	Ø 100 mm M14	s 0,3	24
21907	Ø 125 mm M14	s 0,3	24
21908	Ø 150 mm M14	s 0,3	12

CUP BRUSH, KNOTTED - INOX



INOX

M14



· hardened



No.	specification	wire	
22037	Ø 65 mm M14	s 0,5	60
22038	Ø 80 mm M14	s 0,5	24

RADIAL BRUSH, KNOTTED



M14



· hardened



No.	specification	wire	number of knots
21911	Ø 100 mm M14	s 0,5	30 60
21912	Ø 115 mm M14	s 0,5	32 42
21913	Ø 125 mm M14	s 0,5	36 42
21914	Ø 150 mm M14	s 0,5	40 32

RADIAL BRUSH, KNOTTED



M14



· hardened



No.	specification	wire	
22012	Ø 100 mm M14	s 0,5	60
22013	Ø 115 mm M14	s 0,5	42
22014	Ø 125 mm M14	s 0,5	42
22015	Ø 150 mm M14	s 0,5	32
22016	Ø 178 mm M14	s 0,5	20

RADIAL BRUSH, KNOTTED



INOX

M14



· hardened



No.	specification	wire	
22039	Ø 100 mm M14	s 0,5	60
22040	Ø 125 mm M14	s 0,5	42

BEVEL BRUSH, KNOTTED



M14



· hardened



No.	specification	wire	
22017	Ø 100 mm M14	s 0,5	60
21909	Ø 115 mm M14	s 0,5	42
21910	Ø 125 mm M14	s 0,5	42

BEVEL BRUSH, KNOTTED



· hardened



No.	specification	wire	
22023	Ø 75 mm	s 0,5	10

CUP BRUSH KNOTTED, SHANK



· hardened



No.	specification	wire	
22024	Ø 75 mm	s 0,5	12

BEVEL BRUSH KNOTTED, SHANK



· hardened



No.	specification	wire	
22025	Ø 75 mm	s 0,5	12

RADIAL BRUSH BRASS COATED



brass coated



No.	specification	wire	
22026	Ø 50 mm	s 0,3	15
22027	Ø 63 mm	s 0,3	15
22028	Ø 75 mm	s 0,3	10
22029	Ø 100 mm	s 0,3	15

CUP BRUSH BRASS COATED



brass coated



No.	specification	wire	
22030	Ø 65 mm	s 0,3	12
22031	Ø 75 mm	s 0,3	12

END BRUSH, KNOTTED



hardened



No.	specification	wire	
22021	Ø 19 mm	s 0,5	30
22022	Ø 22 mm	s 0,5	25

END BRUSH, SHANK



No.	specification	wire	
22058	Ø 12 mm	s 0,3	25
22059	Ø 25 mm	s 0,3	25

END BRUSH, SHANK, BRASS COATED



brass coated



No.	specification	wire	
22018	Ø 12 mm	s 0,3	15
22019	Ø 17 mm	s 0,3	15
22020	Ø 25 mm	s 0,3	25

RADIAL BRUSH, NYLON



No.	specification	wire	
21930	Ø 125 mm	M14 1,2 mm	10
21931	Ø 150 mm	M14 1,2 mm	15

CUP BRUSH, NYLON



No.	specification	wire	
21940	Ø 75 mm	M14 1,2 mm	1
21941	Ø 100 mm	M14 1,2 mm	1

RADIAL BRUSH, NYLON, STALK

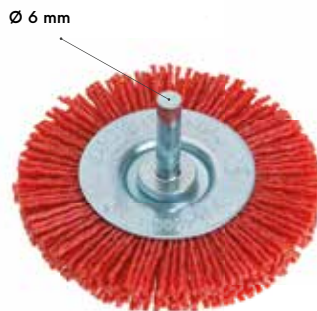

No.	specification	wire	
21935	Ø 50 mm	1,2 mm	1
21936	Ø 75 mm	1,2 mm	1
21937	Ø 100 mm	1,2 mm	1

FLAPPER BRUSH, NYLON, SHANK

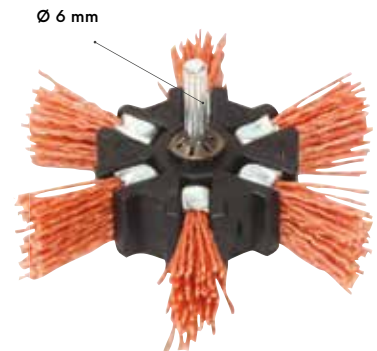

No.	specification	wire	
22032	Ø 100 mm	1,2 mm	12

WIRE BRUSH



No.	specification	wire	
22158	200 mm	steel	1
22159	200 mm	brass	1

WIRE BRUSH, PLASTIC



No.	specification	wire	
22035	270 mm	steel	24
22036	270 mm	stainless steel	24

WIRE BRUSH



No.	specification	lines	
22033	300 mm	4 lines	12
22034	300 mm	5 lines	12

WIRE BRUSH BRASS COATED



No.	lines	
22078	3 lines	20

WIRE BRUSH BRASS COATED



No.	specification	lines	
22079	300 mm	4 lines	10

WIRE BRUSH, PLASTIC



No.	specification	lines	
22080	270 mm	5 lines	12



HAND BRUSH, BRASS



No.	specification	lines	
22082	300 mm	5 lines	12



WIRE BRUSH, STEEL, BRUSH COATED - SET

3x



No.	lines	
22081	3 lines	10



WIRE BRUSH, STEEL, BRUSH COATED - SET

3x



No.	specification	wire	
22086	180 mm	nylon, inox, brass	12



DIAMOND POLISHING DISC Ø 100 MM, WITH VELCRO



M14



- ceramic tiles
- glass
- marble
- granite

No.	asperity	
22701	50	1
22702	100	1
22703	200	1
22704	400	1
22705	800	1
22706	1500	1
22707	3000	1

BACKING PAD, BIND WITH VELCRO



- M14 | Ø 8 mm
- EVA10 mm

No.	specification	
22062	Ø 115 mm	25
22063	Ø 125 mm	25
22064	Ø 150 mm	10

BACKING PAD FOR FIBER DISC

M14



No.	specification	
22073	Ø 125 mm, M14	1
22074	Ø 150 mm, M14	1

BACKING PAD FOR DIAMOND POLISHING DISCS

M14



- for angle grinding machine

No.	specification	
22043	Ø 100 mm with velcro	1

BACKING PAD

M14



- for angle grinding machine

No.	specification	
22044	Ø 125 mm	15
22060	Ø 150 mm	6

ADAPTER

NEW

M14

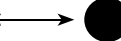

No.	specification	
22087		1

BACKING PAD



No.	specification	
22061	Ø 125 mm bind with velcro Ø 8 mm	5

BACKING PAD



No.	specification	
22041	Ø 125 mm bind with screw	11
22042	Ø 125 mm bind with velcro	11

POLISHING PAD



No.	specification	
22065	Ø 125 mm bind with velcro	20
22066	Ø 150 mm bind with velcro	20

FLAPPER BRUSH FLEECE



No.	specification	
22068	Ø 125 mm	20
22069	Ø 150 mm	20

POLISHING FELT WITH VELCRO

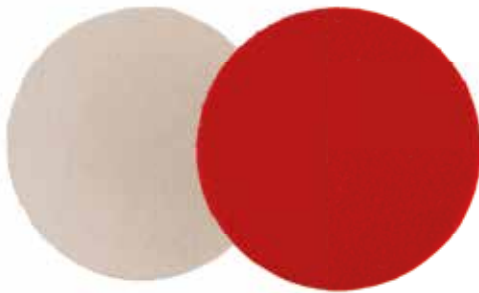

No.	specification	
22070	Ø 115 mm	20
22071	Ø 125 mm bind with velcro	20
22072	Ø 150 mm	20

NYLON BRUSH DISCK



Ø 6 mm

No.	specification	
22091	Ø 50 mm P240	1
22092	Ø 75 mm P240	1
22093	Ø 100 mm P240	1

BRUSH NYLON WITH PAD



No.	specification	
21798	Ø 125 mm Ø 22,2 mm	1

NYLON BRUSH DISC, SHANK



Ø 6 mm



No.	specification	
22088	Ø 65 mm	9
22090	Ø 100 mm	5

BRUSH NYLON WITH PAD



No.	specification	
22083	Ø 115 mm Ø 22,2 mm	10
22084	Ø 125 mm Ø 22,2 mm	10
22085	Ø 150 mm Ø 22,2 mm	10

NYLON BRUSH DISC



No.	specification	
22095	Ø 178 mm	1

FIBER DISC - Ø 125 MM

3x



No.	asperity	
22160	P40	1
22161	P60	1
22162	P80	1
22163	P100	1
22164	P120	1

FIBER DISC - Ø 150 MM

3x



No.	asperity	
22165	P40	1
22166	P60	1
22167	P80	1
22168	P100	1
22169	P120	1

SANDING PAPER Ø 125 MM, WITH VELCRO

3x



No.	asperity	
22045	P40	1
22046	P60	1
22047	P80	1
22048	P100	1
22049	P120	1
22050	P150	1
22051	P180	1
22052	P220	1

SANDING PAPER Ø 150 MM, WITH VELCRO

3x



No.	asperity	
22053	P40	1
22054	P60	1
22055	P80	1
22056	P100	1
22057	P120	1

VIBRATORY CUT - 94 X 94 X 94 MM

5x



No.	asperity	
21831	P60	1
21832	P80	1
21834	P120	1

SANDING PAPER, WITH VELCRO 125 MM

3x



No.	asperity	
22096	P40	20
22097	P60	20
22098	P80	20
22099	P120	20

ENDLESS SANDING BELT - 75 X 533 MM

3x



No.	asperity	
21810	P40	20
21811	P60	20
21812	P80	20
21813	P100	20
21814	P120	20

SANDING PAPER 93 X 230 MM

5x

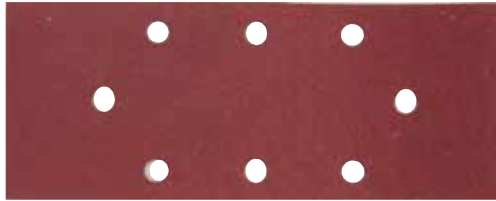

SANDING PAPER 115 X 280 MM

5x



No.	asperity	number of holes	
21740	P40	8	20
21741	P60	8	20
21742	P80	8	20
21743	P100	8	20
21744	P120	8	20

No.	asperity	number of holes	
21750	P40	10	20
21751	P60	10	20
21752	P80	10	20
21753	P100	10	20
21754	P120	10	20

SANDING CLOTH 230 X 280 MM

10x



SANDING PAPER WATERPROOF 230 X 280 MM

10x





SANDING PAPER 230 X 280 MM

10x



No.	asperity	
21732	P40	1
21734	P60	1
21735	P80	1
21736	P100	1
21737	P120	1

No.	asperity	
21701	P60	1
21702	P80	1
21703	P100	1
21704	P120	1
21705	P150	1
21706	P180	1
21709	P240	1

No.	asperity	
21715	P40	1
21716	P60	1
21717	P80	1
21718	P100	1
21719	P120	1
21720	P150	1
21721	P180	1
21724	P240	1

HOLDER FOR SANDING PAPER 170 X 70 MM

FESTA

HOLDER FOR SANDING PAPER



HOLDER FOR SANDING PAPER 125 X 68 MM



• quick grip

No.	specification	
22067	170 x 70 mm beech handle	10

No.	specification	
22075	210 x 105 mm plastic	60
22076	160 x 85 mm plastic	60

No.	specification	
22077	125 x 68 mm rubber	60

DIAMOND SANDING SPONGE BLOCK

FESTA

90 x 55 x 25 mm



- ceramic tiles
- glass
- marble
- granite

No.	asperity	
22115	P60	1
22116	P120	1
22117	P200	1

GRINDING LAMELL DISC WITH SHANK



No.	asperity		
21850	P40		1
21851	P60		1
21852	P80	20 x 20, Ø 6 mm	1
21853	P100		1
21854	P120		1
21855	P40		1
21856	P60		1
21857	P80	30x30, Ø 6mm	1
21858	P100		1
21859	P120		1
21860	P40		1
21861	P60		1
21862	P80	60x30, Ø 6mm	1
21863	P100		1
21864	P120		1

SANDING SPONGE BLOCK 100 X 70 X 28 MM - BEVELED

FESTA

NEW



No.	asperity	
22106	P 60	10
22107	P 80	10
22108	P 100	10
22109	P 120	10

SANDING SPONGE BLOCK 100 X 70 X 25 MM

FESTA



No.	asperity	
22100	P60	20
22101	P80	20
22102	P100	20
22103	P120	20
22104	P180	20
22105	P220	20

SANDING SPONGE BLOCK 120 X 95 X 10 MM

FESTA

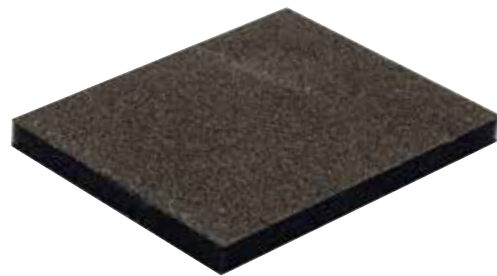

No.	asperity	
22110	P80	20
22111	P120	20
22112	P180	20
22113	P220	20



DRYWALL TOOLS

DRYWALL RASP



No.	specification	
22120	250 x 40 mm	10

DRYWALL RASP



No.	specification	
22121	250 x 40 mm	10
22122	140 x 40 mm	6

DRYWALL RASP



No.	specification	
22126	155 x 40 mm	1

DRYWALL RASP



No.	specification	
22125	Ø 250 x 40 mm	6

DRYWALL RASP



No.	specification	
22124	Ø 250 x 16 mm	10

DRYWALL RASP



No.	specification	
22123	60 x 40 mm	6

SAW FOR DRYWALL



No.	specification	
24159	150 mm	12

PLANE FOR DRYWALL



No.	specification	
34315		10
34316	spare blade	1

DRILLING SAW FOR DRYWALL



No.	specification	
24190	270 mm	10

DRILLING SAW FOR DRYWALL RASP



No.	specification	
22130	250 x 40 mm	20
22129	155 x 40 mm	20
22132	140 x 40 mm	20
22133	60 x 40 mm	20
22134	Ø 16 x 250 mm	20



RASP AND FILES

FESTA®

FLAT FILE



FESTA®



FOURSQUARE FILE

FESTA®



No.	specification	asperity	
22184	250 mm	2	10

CABINET FILE

FESTA®



No.	specification	asperity	
22207	150 mm	2	10
22182	250 mm	2	10

TRIANGULAR FILE

FESTA®



No.	specification	asperity	
22183	250 mm	2	10

TRIANGULAR FILE FOR SAW BLADES

FESTA®



No.	specification	asperity	
22178	150 mm	1	10

ROUND FILE

FESTA®



No.	specification	asperity	
22181	250 mm	2	10

FILE SET

FESTA®



5x



No.	specification	asperity	
22209	150 mm	2	10
22186	250 mm	2	5

FILE SET

FESTA®



3x



No.	specification	asperity	
22208	150 mm	2	10
22185	250 mm	2	5

FLAT RASP



No.	specification	
22202	150 mm	10
22197	300 mm	10

ROUND RASP



No.	specification	
22204	150 mm	10
22205	250 mm	10
22198	300 mm	10

CABINET RASP



No.	specification	
22203	150 mm	6
22199	300 mm	6

RASP SET



3x



No.	specification	
22195	300 mm	5

FILE FOR CHAIN SAW



No.	specification		No.	specification	
22170	200 mm 3,5 mm	20	22173	200 mm 5 mm	10
22171	200 mm 4 mm	10	22174	200 mm 5,5 mm	10
22172	200 mm 4,5 mm	10			

NEEDLE FILE SET



10x



No.	specification	
22188		20

SET FOR CHARPENING SAW CHAIN



No.	specification	
22190	300 mm	5

DIAMOND FILE SET



10x



No.	specification	
22189		25

FESTA®



No.	specification	number of teeth	
Ø 115 mm			
22300	Ø 115 x 22 mm	40	1
Ø 125 mm			
22301	Ø 125 x 22 mm	40	1
Ø 140 mm			
22302	Ø 140 x 20 mm	24	1
22303	Ø 140 x 20 mm	30	1
Ø 150 mm			
22305	Ø 150 x 20 mm	24	1
Ø 160 mm			
22307	Ø 160 x 20 mm	18	1
22309	Ø 160 x 20 mm	24	1
22310	Ø 160 x 20 mm	30	1
22311	Ø 160 x 20 mm	36	1
22312	Ø 160 x 20 mm	48	1
22313	Ø 160 x 20 mm	60	1
Ø 165 mm			
22314	Ø 165 x 20 mm	24	NEW 1
Ø 180 mm			
22315	Ø 180 x 30 mm	24	1
22317	Ø 180 x 30 mm	50	1
22318	Ø 180 x 20 mm	50	1
Ø 190 mm			
22319	Ø 190 x 20 mm	40	1
22320	Ø 190 x 30 mm	40	1
Ø 200 mm			
22322	Ø 200 x 30 mm	24	1
22324	Ø 200 x 30 mm	40	1
22326	Ø 200 x 30 mm	60	1
Ø 205 mm			
22328	Ø 205 x 30 mm	40	1
22329	Ø 205 x 30 mm	60	1
Ø 210 mm			
22332	Ø 210 x 30 mm	40	1
22333	Ø 210 x 30 mm	60	1
Ø 250 mm			
22335	Ø 250 x 30 mm	40	1
22337	Ø 250 x 30 mm	60	1
Ø 300 mm			
22340	Ø 300 x 30 mm	40	1
22343	Ø 300 x 30 mm	60	1
22345	Ø 300 x 30 mm	96	1
Ø 350 mm			
22350	Ø 350 x 30 mm	40	1
22351	Ø 350 x 30 mm	54	1
Ø 400 mm			
22355	Ø 400 x 30 mm	40	1
22357	Ø 400 x 30 mm	60	1
Ø 500 mm			
22365	Ø 500 x 30 mm	60	1
Ø 600 mm			
22370	Ø 600 x 30 mm	60	1

CIRCULAR SAW BLADE TCT

FESTA®

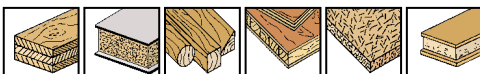

DISTANCE RING



No.	specification	
22399	Ø 20 16 mm	1
22398	Ø 30 25 mm	1

**PROFESIONAL JIG SAW BLADES
MADE IN GERMANY BY CAUTERIZING WITH LASER**

JIG SAW BLADES FIT JIG SAW LIKE: AEG, BOSCH, FESTO, MAKITA, METABO

	24060	50mm/1mm	0,7 mm/ 36TPI	31007	5 pcs	10
	24061	50mm/1mm	1,2 mm/ 21TPI	31012	5 pcs	10
	24062	50mm/1mm	2,0 mm/ 13TPI	31020	5 pcs	10
	24063	75mm/1mm	3,0 mm/ 8TPI	31030	5 pcs	10
	24064	100mm/1mm	1,2 mm/ 21TPI	31112	5 pcs	10
	24065	100mm/1,3mm	2,0 mm/ 13TPI	31112	5 pcs	10
	24066	75mm/1,45mm	2,0 mm/ 13TPI	31220	5 pcs	10
	24067	120mm/1,3mm	1,8 - 2,4 mm/ 10 - 14 TPI	31220	5 pcs	10
	24068	75mm/1,45mm	2,5 mm/ 10 TPI	32225	5 pcs	10
	24069	75mm/1,45mm	4 mm/ 6 TPI	32240	5 pcs	10
	24070	75mm/1,3mm	4 mm/ 6 TPI	32340	5 pcs	10
	24071	75mm/1,3mm	4 mm/ 6 TPI	32440	5 pcs	10
	24072	75mm/1,45mm	2,5 mm/ 10 TPI	32625	5 pcs	10
	24073	85mm/1,45mm	3 mm/ 8 TPI	32730	5 pcs	10
	24074	85mm/1,45mm	4 mm/ 6 TPI	32730	5 pcs	10
	24075	75mm/1,45mm	2,5 1,2 mm/10 21 TPI	32825	5 pcs	10
	24076	75mm/1,7mm	4 mm 6 TPI	32940	5 pcs	10
	24077	120mm/1,3mm	4 mm 6 TPI	32040	5 pcs	10
	24078	105mm/1,45mm	4 mm 6 TPI	34040	5 pcs	10
	24055	55mm	carbide		5 pcs	1

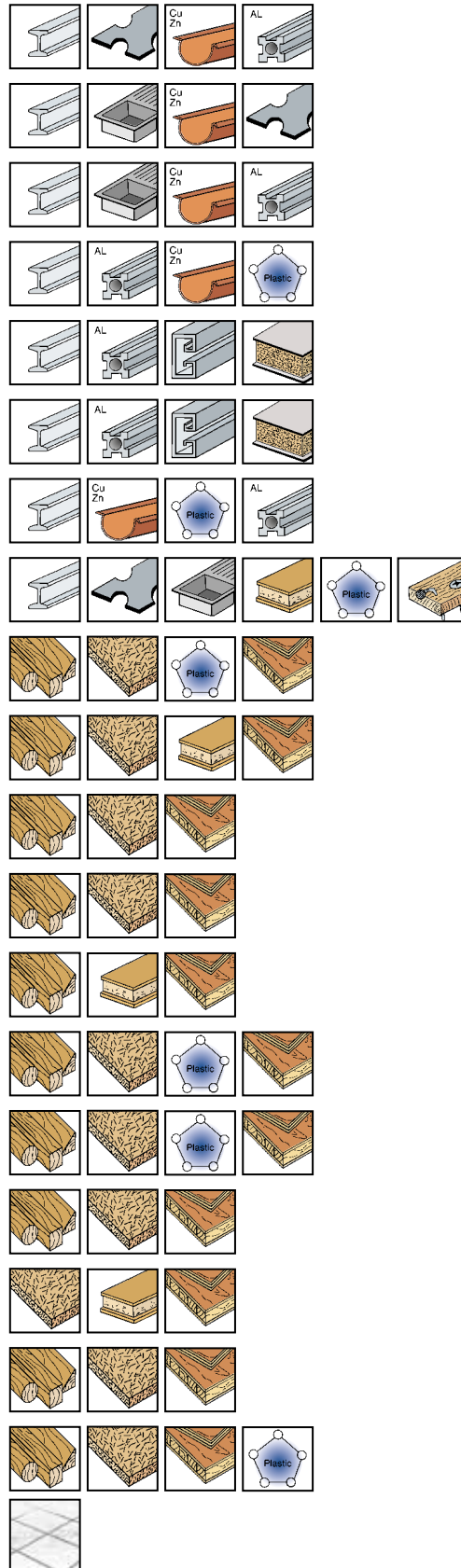

JIG SAW BLADES FIT JIG SAW LIKE: BLACK & DECKER, SKIL, FERM



No.	specification	5 pcs	10	Material
24080	50mm 1,0 mm 1,2 21 TPI	11012	5 pcs	10
24081	75mm 1,0 mm 3,0 8 TPI	11030	5 pcs	10
24082	75mm 1,45 mm 2,5 10 TPI	12225	5 pcs	10
24083	75mm 1,45 mm 4 6 TPI	12240	5 pcs	10
24084	75mm 1,3 mm 4 6 TPI	12340	5 pcs	10
24085	50mm 1,0 mm 2,0 13 TPI	12420	5 pcs	10
24086	75mm 1,3 mm 4,0 6 TP	12440	5 pcs	10
24087	75mm 1,45 mm 2,5 10 TPI	12625	5 pcs	10

	mild steel		sheet metal		stainless steel		laminated boards
	non-ferrous-metals		hard and soft wood		chipboards		plastic
	plywood		batten board		nail infested wood		
	sandwichmaterial		tile		aluminium		

JIG SAW BLADES SET

5x

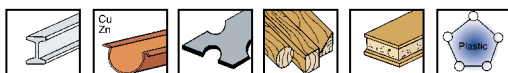

No.	specification	50
24045	set	50

JIG SAW BLADES STAND



· items in stand 24098

24060	· 5 pcs
24080	· 5 pcs
24061	· 5 pcs
24062	· 5 pcs
24081	· 5 pcs
24063	· 5 pcs
24066	· 5 pcs
24067	· 5 pcs
24082	· 5 pcs
24068	· 5 pcs
24083	· 5 pcs
24069	· 5 pcs
24084	· 5 pcs
24070	· 5 pcs
24086	· 5 pcs
24071	· 5 pcs
24087	· 5 pcs
24072	· 5 pcs
24073	· 5 pcs
24074	· 5 pcs
24075	· 5 pcs
24076	· 5 pcs

No.	specification	1
24099	64 x 50 cm - without blades	1
24098	64 x 50 cm - with blades	1

SAW BLADE



HCS 3x

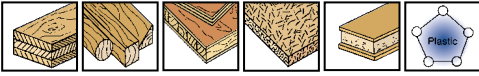

No. specification
24301 150 x 19 x 1,3 mm TPI 6

1

SAW BLADE



HCS 3x

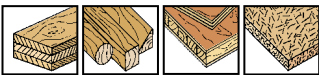

No. specification
24302 225 x 19 x 1,3 mm TPI 3

1

SAW BLADE



HCS 3x

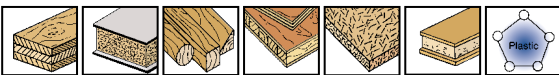

No. specification
24303 200 x 19 x 1,3 mm TPI 6 - 10

1

SAW BLADE



HCS 3x

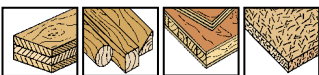

No. specification
24304 240 x 19 x 1,5 mm TPI 5

1

SAW BLADE



Bi Metal 3x

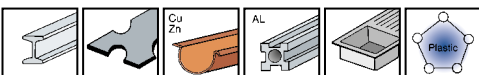

No. specification
24305 150 x 19 x 1 mm TPI 24

1

SAW BLADE



Bi Metal 3x

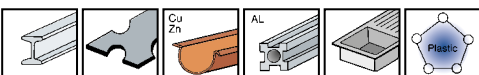

No. specification
24306 150 x 19 x 1 mm TPI 9

1

SAW BLADE

FESTA

Bi Metal **3x**

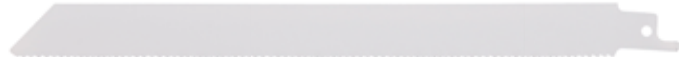
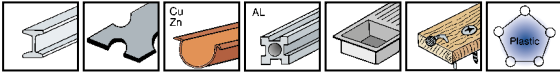

No. specification
24308 225 x 19 x 1 mm TPI 10 - 14



SAW BLADE

FESTA

Bi Metal **3x**

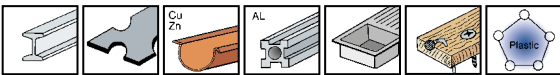

No. specification
24310 150 x 22 x 1,6 mm TPI 9



SAW BLADE

FESTA

Bi Metal **3x**

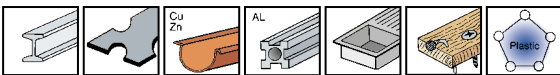

No. specification
24313 225 x 22 x 1,6 mm TPI 6



HSS JIG SAW FOR METALS

FESTA

HSS

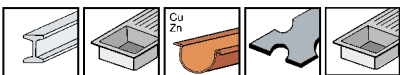

No. specification
24050 203 x 19 x 1 mm TPI 10 - 14

SAW BLADE

FESTA

TC **3x** carbide technology, long life

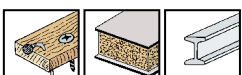

No. specification
24312 225 x 19 x 1,3 mm TPI 6 - 9



SAW BLADE

FESTA

NEW **TC**



No. specification
24315 305 x 50 x 1,5 mm



SAW BLADE SET



Bi Metal HCS 3x

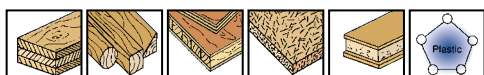

- 24301
- 24304
- 24305

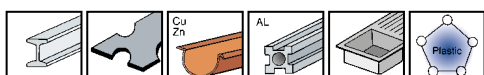
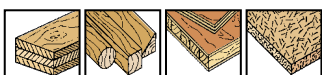

No.	specification
24314	

1

HACKSAW BLADE



- heat treated teeth

No.	specification	
24185	533 mm	1
24186	610 mm	1
24187	760 mm	1
24188	800 mm	1
24189	914 mm	1

SAW BLADE



- heat treated teeth

No.	specification	
24169	350 mm	10
24167	450 mm	10
24166	533 mm	10
24163	610 mm	10
24164	760 mm	10
24168	800 mm	10
24165	914 mm	10

HACKSAW BLADE



No.	specification	
24195	span 3 mm 300 mm	1
24196	span 4 mm 300 mm šikmý zub angled tooth	1
24197	span 5 mm 300 mm kalený zub hardened tooth	1
24192	blade for butcher saw 450 mm	1

HACKSAW BLADE



No.	specification	
24160	span 3 mm 300 mm	20
24161	span 4 mm 300 mm	20
24162	span 5 mm 300 mm	50

HACKSAW BLADE

10x



No.	specification	
24108	6 mm 150 mm	1

ROD SAW BLADE



No.	specification	
24120	300 mm	50

SAW BLADE BI - METAL

FESTA



8 % COBALT



No.	specification	
24180	300 mm	125

HACKSAW BLADE

FESTA



MOQ

No.	specification	
24109	12,5 mm 300 mm for metal	144
24118	25 mm 300 mm for metal double sided	72
24119	25 mm 300 mm for metal and wood	72

METAL HAND SAW

FESTA



No.	specification	
24104	300 mm	6

METAL HAND SAW

FESTA

HAND SAW FOR METAL

FESTA



heavy duty



No.	specification	
24102	300 mm	6



No.	specification	
24103	300 mm	6

HAND SAW FOR METAL

HAND SAW FOR METAL



No.	specification	
24153	300 mm	12

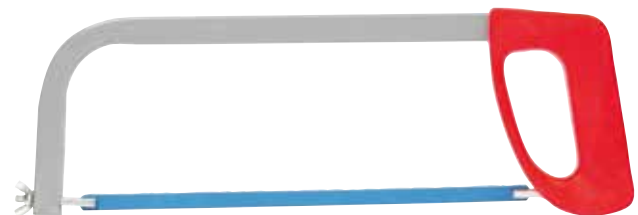

No.	specification	
24100	300 mm	12

HAND SAW FOR METAL



No. specification
24170 300 mm

12

HACKSAW

· blades 24108



No. specification
24125 150 mm

6

HAND SAW

NEW



No. specification
24121 1
24110 saw blade 1



1
1

HAND SAW FOR METAL

FESTA

2x

MADE IN EU



No. specification
24126 300 x 25 x 0,65 mm TPI 24 | 14

1

HACKSAW

· blades 24109



No. specification
24124 260 mm

10

HAND SAW

NEW

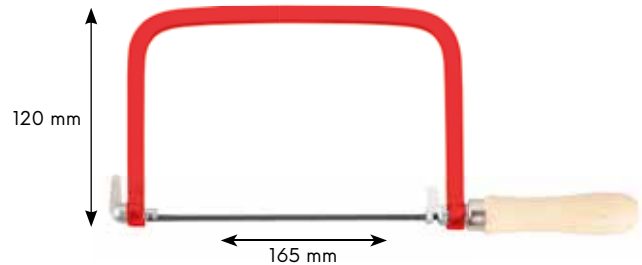

No. specification
24122 1
24111 saw blade 1



1
1

HAND SAW



TEFLON



· 3 x sharpened and heat treated teeth

No.	specification	
24143	300 mm	12
24144	400 mm	12
24145	500 mm	12

TENON SAW



TEFLON



· 3 x sharpened and heat treated teeth

No.	specification	
24147	300 mm	6

WOOD HAND BOARD SAW



· 3 x sharpened and heat treated teeth

No.	specification	
24149	300 mm	12

MITER SAW

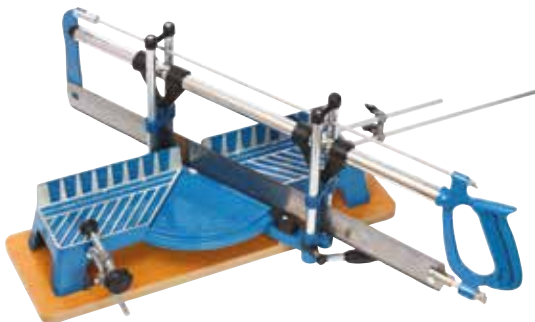

No.	specification	
24130	600 mm	1
24131	600 mm, saw blade	1

MITER BOX PLASTIC



No.	specification	
24133	300 x 140 mm	1

MITER BOX WOODEN



· beech

No.	specification	
24171	80 x 300 mm	10

MITER BOX PLASTIC + SAW



No.	specification	
24148	300 mm	12

PRUNING SAW



• heat treated teeth

No.	specification		No.	specification	
24141	450 mm	1	24136	760 mm	1
24140	533 mm	1	24142	800 mm	1
24135	610 mm	1	24137	914 mm	1

SWIVEL SAW



• heat treated teeth

No.	specification	
24173	350 mm	24

WOOD CUTTING STAND

NEW

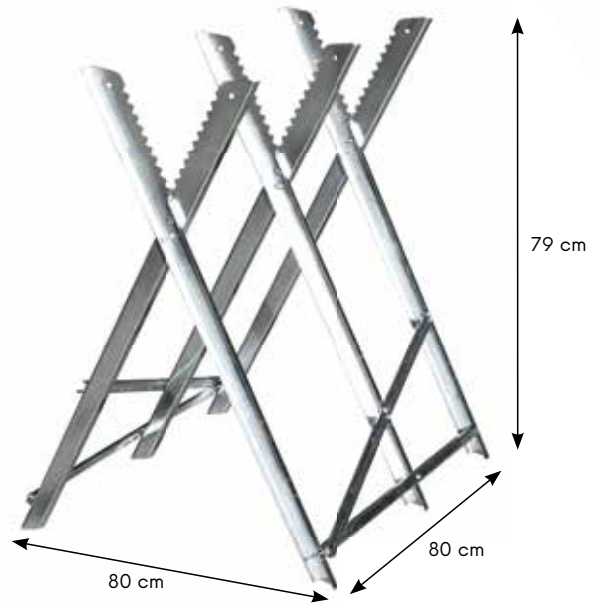

No.	specification	
37570	max. 150 kg	1

PRUNING HAND SAW



No.	specification	
24151	300 mm	10

PRUNING SAW

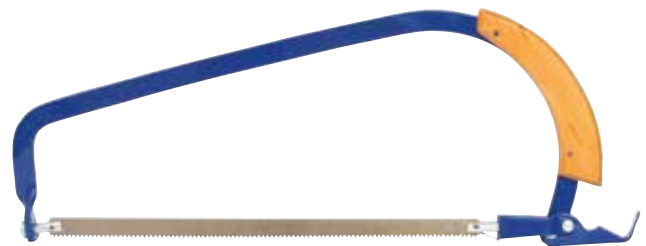

No.	specification	
24150	300 mm	10

PRUNING HAND SAW



No.	specification	
24154	300 mm	10

SAW

INOX



No.	specification	
24128	450 mm blades 24192	6

FOLDING SAW



· 3 x sharpened and heat treated teeth



No.	specification
45061	150 mm with cover of handle

12

FOLDING SAW



· 3 x sharpened and heat treated teeth



No.	specification
45060	180 mm

6

SAW WITH CASE



· 3 x sharpened and heat treated teeth



No.	specification
45062	260 mm with case

24

PRUNING HAND SAW



· 3 x sharpened and heat treated teeth



No.	specification
24152	350 mm 7 tpi

8

TELESCOPIC POLE SAW



· 3 x sharpened and heat treated teeth

No.	specification
45033	230 - 490 mm

1

CATTERPILAR WITH SAW



No.	specification
45030	saw 30 cm telescopic pole 260 cm
45031	saw 30 cm

12

10

CATTERPILAR



No.	specification
45032	metal caterpillar without saw

10

POLYSTYRENE SAW



No.	specification	
24174	370 mm	1

DRYWALL SAW



· 3 x sharpened and heat treated teeth



No.	specification	
24159	150 mm	12

DRILLING SAW FOR DRYWALL



No.	specification	
24190	270 mm	10

SAW FOR POROTHERM



No.	specification	
24181	550 mm	1

CONCRETE SAW



No.	specification	
24158	22 22 SK teeth - 450 mm	5

CONCRETE SAW



No.	specification	
24155	34 17 SK teeth - 630 mm	2
24156	34 34 SK teeth - 630 mm	2

CONCRETE SAW



No.	specification	
24176	34 17 SK teeth - 750 mm	6
24177	34 34 SK teeth - 750 mm	6

CONCRETE SAW







· heat treated teeth

No.	specification	
24175	without SK teeth - 600 mm EU	6
24178	without SK teeth - 600 mm	6

FESTA®





Using cutting diamond blades

				
materials	festa industry	full	turbo	segment
brick	••	••	••	••
tile	••	•••	••	-
stone	••	••	••	••
concrete	•••	•	•••	•••
reinforced concrete	•••	-	•••	-
roof tiles	••	•	••	••
glass and ceramics	-	•••	-	-
marble	•	••	•	•
granite	•••	••	•••	••
sandstone	••	-	••	••
asphalt	-	••	-	••
quartz	••	•	••	•

DIAMOND DISC FESTA INDUSTRY

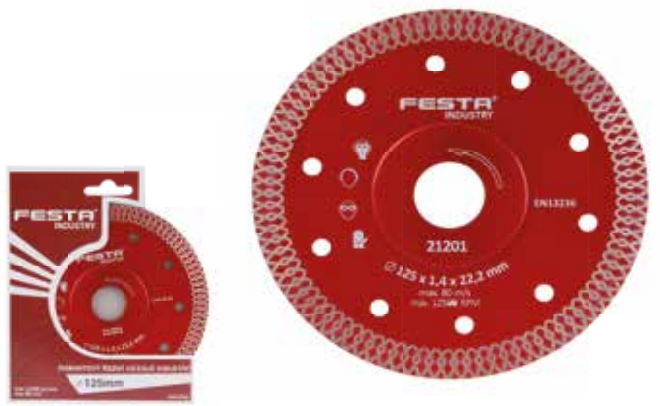

FESTA®
INDUSTRY

No.	specification				
21200	Ø 115 mm	1,4 mm	Ø 22,2 mm	1	
21201	Ø 125 mm	1,4 mm	Ø 22,2 mm	1	
21204	Ø 200 mm	1,8 mm	Ø 25,4 mm	1	
21203	Ø 230 mm	1,8 mm	Ø 22,2 mm	1	



DIAMOND DISC FULL



FESTA®

No.	specification				
21210	Ø 110 mm	Ø 22,2 mm		1	
21211	Ø 115 mm	Ø 22,2 mm		1	
21212	Ø 125 mm	Ø 22,2 mm		1	
21215	Ø 150 mm	Ø 22,2 mm		1	
21218	Ø 180 mm	Ø 22,2 mm		1	
21219	Ø 180 mm	Ø 25,4 mm		1	
21220	Ø 200 mm	Ø 25,4 mm		1	
21223	Ø 230 mm	Ø 22,2 mm		1	
21224	Ø 300 mm	Ø 25,4 mm		1	



DIAMOND DISC SEGMENTED

FESTA®

No.	specification				
21311	Ø 115 mm	Ø 22,2 mm		1	
21312	Ø 125 mm	Ø 22,2 mm		1	
21315	Ø 150 mm	Ø 22,2 mm		1	
21318	Ø 180 mm	Ø 22,2 mm		1	
21323	Ø 230 mm	Ø 22,2 mm		1	
21324	Ø 300 mm	Ø 25,4 mm		1	
21325	Ø 350 mm	Ø 25,4 mm		1	
21326	Ø 400 mm	Ø 25,4 mm		1	



DIAMOND DISC TURBO



No.	specification	
21410	Ø 110 mm Ø 22,2 mm	1
21411	Ø 115 mm Ø 22,2 mm	1
21412	Ø 125 mm Ø 22,2 mm	1
21415	Ø 150 mm Ø 22,2 mm	1
21418	Ø 180 mm Ø 22,2 mm	1
21423	Ø 230 mm Ø 22,2 mm	1
21424	Ø 300 mm Ø 25,4 mm	1



DIAMOND DISC FULL



No.	specification	
21010	Ø 110 mm Ø 22,2 mm	1
21011	Ø 115 mm Ø 22,2 mm	1
21012	Ø 125 mm Ø 22,2 mm	1
21015	Ø 150 mm Ø 22,2 mm	1
21018	Ø 180 mm Ø 22,2 mm	1
21023	Ø 230 mm Ø 22,2 mm	1



DIAMOND DISC SEGMENTED



No.	specification	
21110	Ø 110 mm Ø 22,2 mm	1
21111	Ø 115 mm Ø 22,2 mm	1
21112	Ø 125 mm Ø 22,2 mm	1
21115	Ø 150 mm Ø 22,2 mm	1
21118	Ø 180 mm Ø 22,2 mm	1
21123	Ø 230 mm Ø 22,2 mm	1



DIAMOND DISC TURBO



No.	specification	
21130	Ø 110 mm Ø 22,2 mm	1
21135	Ø 115 mm Ø 22,2 mm	1
21140	Ø 125 mm Ø 22,2 mm	1
21150	Ø 150 mm Ø 22,2 mm	1
21180	Ø 180 mm Ø 22,2 mm	1
21190	Ø 230 mm Ø 22,2 mm	1



DIAMOND DISCS SEGMENTED, DOUBLE

FESTA



6 mm



No.	specification	
21195	Ø 125 x 22,2 mm	1

DIAMOND DISC GRINDING DOUBLE BRESTED

FESTA



No.	specification	
21430	Ø 115 mm Ø 22,2 mm	1
21431	Ø 125 mm Ø 22,2 mm	1
21432	Ø 150 mm Ø 22,2 mm	1

DIAMOND DISC GRINDING TURBO

FESTA



No.	specification	
21425	Ø 100 mm Ø 22,2 mm	1
21426	Ø 115 mm Ø 22,2 mm	1
21427	Ø 125 mm Ø 22,2 mm	1
21428	Ø 150 mm Ø 22,2 mm	1

UNIVERSAL CUTTING DISC - DIAMOND

FESTA



No.	specification	
21301	Ø 125 mm Ø 22,2 mm 1,8 mm	1
21303	Ø 230 mm Ø 22,2 mm 1,8 mm	1

CUTTING DISC FOR METAL



No.	specification	
22258	NEW Ø 115 mm Ø 22,2 mm x 0,8 mm	25
22263	Ø 115 mm Ø 22,2 mm x 1,6 mm	25
22264	Ø 115 mm Ø 22,2 mm x 2 mm	25
22259	NEW Ø 125 mm Ø 22,2 mm x 0,8 mm	25
22266	Ø 125 mm Ø 22,2 mm x 1 mm	25
22270	Ø 125 mm Ø 22,2 mm x 2 mm	25
22273	Ø 150 mm Ø 22,2 mm x 1,6 mm	25
22274	Ø 150 mm Ø 22,2 mm x 2 mm	25
22275	Ø 150 mm Ø 22,2 mm x 2,5 mm	25
22277	Ø 180 mm Ø 22,2 mm x 2 mm	25
22280	Ø 230 mm Ø 22,2 mm x 2 mm	25
22281	Ø 230 mm Ø 22,2 mm x 2,5 mm	25

CUTTING DISC FOR ALUMINIUM



NEW



No.	specification	
22285	Ø 115 mm Ø 22,2 mm x 1 mm	1
22286	Ø 125 mm Ø 22,2 mm x 1 mm	1

CUTTING DISC FOR METAL



No.	specification	
22211	Ø 115 mm Ø 22,2 mm x 1 mm	INOX 50
22212	Ø 115 mm Ø 22,2 mm x 1,2 mm	INOX 50
22225	Ø 125 mm Ø 22,2 mm x 1 mm	INOX 50
22217	Ø 125 mm Ø 22,2 mm x 1,2 mm	INOX 50
22251	Ø 115 mm Ø 22,2 mm x 1,6 mm	50
22215	Ø 115 mm Ø 22,2 mm x 2 mm	50
22216	Ø 115 mm Ø 22,2 mm x 2,5 mm	50
22252	Ø 125 mm Ø 22,2 mm x 1,6 mm	25
22218	Ø 125 mm Ø 22,2 mm x 2,5 mm	25
22219	Ø 150 mm Ø 22,2 mm x 1,2 mm	25
22253	Ø 150 mm Ø 22,2 mm x 1,6 mm	50
22220	Ø 150 mm Ø 22,2 mm x 2,5 mm	50
22254	Ø 180 mm Ø 22,2 mm x 1,6 mm	50
22222	Ø 180 mm Ø 22,2 mm x 2,5 mm	25
22255	Ø 230 mm Ø 22,2 mm x 1,6 mm	25
22224	Ø 230 mm Ø 22,2 mm x 2,5 mm	25

GRINDING DISC FOR METAL



No.	specification	
22240	Ø 115 mm Ø 22,2 mm x 6,4 mm	25
22242	Ø 125 mm Ø 22,2 mm x 6,4 mm	25
22244	Ø 150 mm Ø 22,2 mm x 6,4 mm	25
22246	Ø 180 mm Ø 22,2 mm x 6,4 mm	25
22248	Ø 230 mm Ø 22,2 mm x 6,4 mm	25

CUTTING DISC FOR STONE



No.	specification	
22294	Ø 230 mm Ø 22,2 mm x 3 mm	1

CUTTING DISC FOR STONE



No.	specification	
22230	Ø 115 mm Ø 22,2 mm x 2,5 mm	50
22232	Ø 125 mm Ø 22,2 mm x 2,5 mm	50
22234	Ø 150 mm Ø 22,2 mm x 2,5 mm	25
22236	Ø 180 mm Ø 22,2 mm x 2,5 mm	25
22238	Ø 230 mm Ø 22,2 mm x 2,5 mm	25

CUTTING DISC FOR METAL - DIAMOND



No.	specification	
21306	Ø 125 mm Ø 22,2 mm 1,3 mm	1
21308	Ø 230 mm Ø 22,2 mm 1,8 mm	1

UNIVERSAL CUTTING DISC - CARBIDE



No.	specification	
21192	Ø 125 mm Ø 22,2 mm	1
21194	Ø 230 mm Ø 22,2 mm	1

MULTI-PLATE DISC

FESTA®

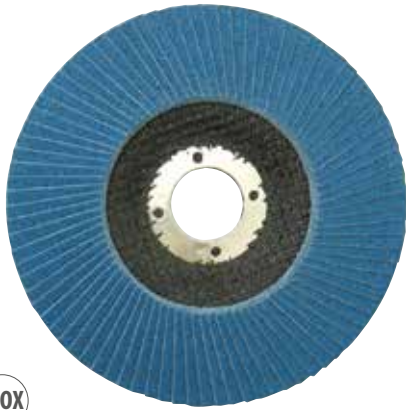

grinding disc suitable for grinding stainless steel

No.	specification	asperity	
22140	Ø 115 mm Ø 22,2 mm	P40	5
22141	Ø 115 mm Ø 22,2 mm	P60	5
22142	Ø 115 mm Ø 22,2 mm	P80	5
22143	Ø 115 mm Ø 22,2 mm	P100	5
22145	Ø 125 mm Ø 22,2 mm	P40	5
22146	Ø 125 mm Ø 22,2 mm	P60	5
22147	Ø 125 mm Ø 22,2 mm	P80	5
22148	Ø 125 mm Ø 22,2 mm	P100	5
22150	Ø 150 mm Ø 22,2 mm	P40	5
22151	Ø 150 mm Ø 22,2 mm	P60	5
22155	Ø 150 mm Ø 22,2 mm	P80	5
22156	Ø 150 mm Ø 22,2 mm	P100	5

MULTI-PLATE DISC



No.	specification	asperity	
21780	Ø 115 mm Ø 22,2 mm	P40	10
21781	Ø 115 mm Ø 22,2 mm	P60	10
21782	Ø 115 mm Ø 22,2 m	P80	10
21783	Ø 115 mm Ø 22,2 mm	P100	10
21784	Ø 115 mm Ø 22,2 mm	P120	10
21786	Ø 125 mm Ø 22,2 mm	P40	10
21787	Ø 125 mm Ø 22,2 mm	P60	10
21788	Ø 125 mm Ø 22,2 mm	P80	10
21789	Ø 125 mm Ø 22,2 mm	P100	10
21790	Ø 125 mm Ø 22,2 mm	P120	10
21792	Ø 150 mm Ø 22,2 mm	P40	10
21793	Ø 150 mm Ø 22,2 mm	P60	10
21794	Ø 150 mm Ø 22,2 mm	P80	10
21795	Ø 150 mm Ø 22,2 mm	P100	10
21796	Ø 150 mm Ø 22,2 mm	P120	10

BRUSH NYLON WITH PAD

NEW



No.	specification	
21798	Ø 125 mm Ø 22,2 mm	1

RASP WHEEL - MEDIUM COARSE

FESTA

NEW



No.	specification			
21802	Ø 125 mm	Ø 22,2 mm	3 mm	1

RASP WHEEL - COARSE

FESTA

NEW



No.	specification			
21801	Ø 125 mm	Ø 22,2 mm	3 mm	1

DISC FOR WOOD WITH HOLES

FESTA



• grinding disc suitable for grinding wood

No.	specification			
21800	Ø 125 mm	Ø 22,2 mm		1



212

TROWELS AND PUTTY KNIVES



222

BAR TROWELS AND SANDING TROWELS



225

FLOATS AND MASSON STAFFS



227

FLOATS



233

DIPPERS



234

MIXERS



238

EXTENSION CABELS



239

ELEKTRIC AND GAS HEATERS



240

BUILDING MIXERS



244

CONSTRUCTON DEBRIS CHUTE



244

WHELLBARROWS



245

FLOOR TILE BREAKERS, CURB HOLDERS

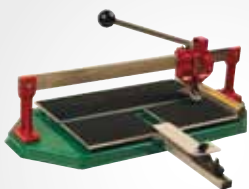

247

TILE CUTTING MACHINES



250

TOOLS FOR WORK WITH TILES



253

LEVELING ACCESSORIES



257

POLYSTYRENE CUTTER



261

PLASTERING SPLASH MACHINES



263

PB HEATERS AND PRESSURE REGULATORS



267

WASTE BAGS

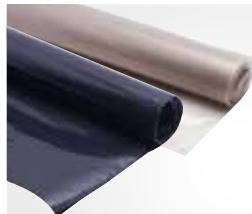

268

WASTE BAGS



269

TAPES

BUILDING TOOLS 210 - 291



273

CAULKING GUNS



275

PU FOAM GUNS



276

HEATING GUNS AND HOT MELT GLUE GUNS



278

PAINTER TOOLS



284

TARPAULINS



286

SNAP HOOKS, CHAINS, WIRE ROPES



289

BUILDING LIGHTS



290

LADDERS



290

CHIMNEY DOORS AND ADJUSTABLE PROPS



TROWELS, PUTTY KNIVES AND SCRAPERS

STAINLESS TROWEL 280 X 130 MM

INOX

· rubber handle

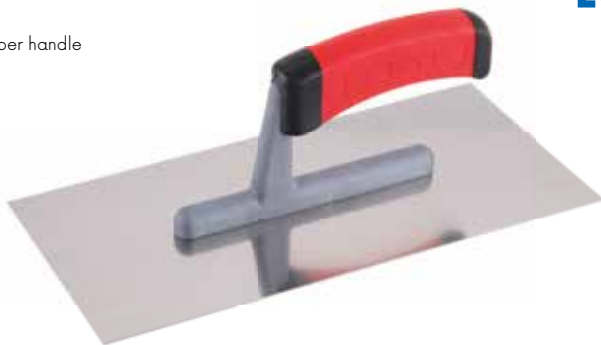

No.	specification
31140	straight

No.	specification
10	

STAINLESS TROWEL 280 X 130 MM

INOX

· rubber handle



No.	specification
31148	straight with rounded corners

No.	specification
10	

NOTCHED STAINLESS TROWEL 280 X 130 MM

INOX

· rubber handle



No.	specification
31146	Ø 16

No.	specification
10	

NOTCHED STAINLESS TROWEL 280 X 130 MM

INOX

· rubber handle



No.	specification	No.	specification	
31141	e 4	10	31144	e 10
31142	e 6	10	31145	e 12
31143	e 8	10		

No.	specification
10	

NOTCHED STAINLESS TROWEL 280 X 130 MM

INOX



No.	specification	No.	specification	
31101	e 4	10	31131	e 10
31111	e 6	10	31132	e 12
31121	e 8	10		

No.	specification
10	

STAINLESS TROWEL 280 X 130 MM

INOX



No.	specification
31091	straight

No.	specification
10	

STAINLESS TROWEL 280 X 130 MM

INOX

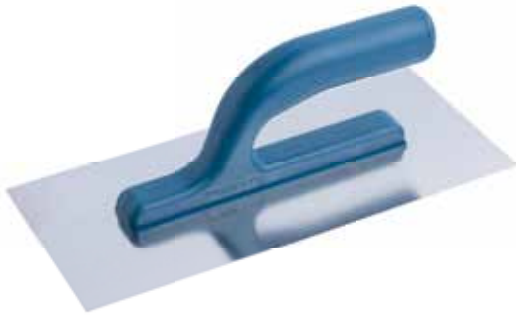

No.	specification	
31011	straight	10

NOTCHED STAINLESS TROWEL 280 X 130 MM

INOX



No.	specification		No.	specification	
31021	e 4	10	31051	e 10	10
31031	e 6	10	31053	e 12	10
31041	e 8	10			

STAINLESS TROWEL 270 X 125 MM

INOX



No.	specification	
31005	straight	25

NOTCHED STAINLESS TROWEL 270 X 125 MM

INOX



No.	specification		No.	specification	
31006	e 4	24	31008	e 8	24
31007	e 6	24	31009	e 10	24

STAINLESS TROWEL 360 X 130 MM

INOX



No.	specification	
31151	straight	10

STAINLESS TROWEL 360 X 130 MM

INOX



No.	specification	
31150	straight	10

STAINLESS TROWEL 480 X 130 MM

INOX



No.	specification	
31082	straight	10

STAINLESS TROWEL 680 X 130 MM

INOX



No.	specification	
31155	straight	10

STAINLESS TROWEL 500 X 130 MM

FESTA®

INOX



No.	specification
31081	straight



10

NOTCHED STAINLESS TROWEL 500 X 130 MM

FESTA®

INOX



No.	specification	
31052	e 4	10
31061	e 6	10
31062	e 8	10
31071	e 10	10
31072	e 12	10

STAINLESS STEEL TROWEL

FESTA®

INOX

· rubber handle



No.	specification	
31232	120 mm	10
31233	140 mm	10



10

No.	specification	
31234	160 mm	10
31235	180 mm	10



10

STAINLESS STEEL TROWEL

FESTA®

INOX



No.	specification	
31220	120 x 80 mm	10
31221	140 x 80 mm	10



10

No.	specification	
31222	160 x 115 mm	10
31231	180 x 120 mm	10



10

STAINLESS STEEL TROWEL

FESTA®

INOX

· rubber handle



No.	specification
31334	160 x 100 mm



10

STAINLESS STEEL TROWEL

FESTA®

INOX



No.	specification
31343	160 x 100 mm



10

STAINLESS STEEL TROWEL

FESTA®

INOX

· rubber handle



No.	specification	
31360	40 mm	10
31380	60 mm	10
31390	80 mm	10



10

No.	specification	
31400	100 mm	10
31403	120 mm	10



10

STAINLESS STEEL TROWEL

FESTA®

INOX



No.	specification	
31362	40 mm	10
31382	60 mm	10



10

No.	specification	
31392	80 mm	10
31402	100 mm	10
31404	120 mm	10



10

CAT TONGUE STAINLESS STEEL TROWEL



INOX

· rubber handle



No.	specification	
31330	140 x 50 mm	10
31340	160 x 60 mm	10

CAT TONGUE STAINLESS STEEL TROWEL



INOX



No.	specification	
31332	140 x 50 mm	10
31341	160 x 60 mm	10

STAINLESS STEEL TROWEL FOR INNER CORNER



INOX

· rubber handle



No.	specification	
31280	80 x 60 x 60 mm	10

STAINLESS STEEL TROWEL FOR INNER CORNER



INOX



No.	specification	
31281	80 x 60 x 60 mm	10

STAINLESS STEEL TROWEL FOR OUTER CORNER



INOX

· rubber handle



No.	specification	
31270	80 x 60 x 60 mm	10

STAINLESS STEEL TROWEL FOR OUTER CORNER



INOX



No.	specification	
31271	80 x 60 x 60 mm	10

STAINLESS STEEL TROWEL



INOX

· rubber handle



No.	specification	
31320	140 x 75 mm	10

STAINLESS STEEL TROWEL



INOX



No.	specification	
31322	140 x 75 mm	10

NOTCHED STAINLESS STEEL TROWEL

FESTA®

INOX



No.	specification	
31218	180 mm e 6	12

STAINLESS STEEL PUTTY KNIFE

FESTA®

INOX

- rubber handle



No.	specification		No.	specification	
31510	40 mm	10	31513	100 mm	10
31511	60 mm	10	31514	120 mm	10
31512	80 mm	10	31515	140 mm	10

STAINLESS STEEL PUTTY KNIFE

FESTA®

INOX



No.	specification		No.	specification	
31461	40 mm	12	31491	100 mm	12
31471	60 mm	12	31467	120 mm	12
31481	80 mm	12	31468	140 mm	12

STAINLESS STEEL SCRAPER

FESTA®

INOX

- rubber handle



No.	specification	
32173	75 mm	10

STAINLESS STEEL SCRAPER

INOX



- thick blade
- recommended pole handle 52010

No.	specification	
32170	100 mm	12

STAINLESS STEEL PUTTY KNIFE WITH BIT

FESTA®

INOX

- rubber handle



No.	specification	
31455	150 mm	12
31456	200 mm	12

STAINLESS STEEL PUTTY KNIFE

FESTA®

INOX



No.	specification	
31498	150 mm	12
31499	200 mm	12
31500	100 mm	12



STAINLESS STEEL PUTTY KNIFE



INOX



No.	specification	
31555	35 cm	1
31556	45 cm	1
31557	60 cm	1

No.	specification	
31558	80 cm	1
31559	100 cm	1

STAINLESS STEEL PUTTY KNIFE



INOX

· rubber handle



No.	specification	
31505	200 mm	5
31506	250 mm	5
31507	300 mm	5

STAINLESS STEEL PUTTY KNIFE

INOX



No.	specification	
31541	250 mm	1
31551	250 mm narrow	1

STAINLESS STEEL SPATULAS WITH REINFORCEMENT



NEW

INOX



No.	specification	
31520	400 mm	1
31521	500 mm	
31522	600 mm	

STAINLESS STEEL SPATULAS WITH REINFORCEMENT - ACCESSORIES



NEW



No.	specification	
31523	ALU holder	1
31524	plastic holder	1
31525	KULOGRIF holder	1
31526	wooden handle with metal internal thread - 130cm	1

STAINLESS STEEL PUTTY KNIFE

MADE IN
EU

INOX



No.	specification	
31493	40 mm	20
31494	60 mm	20
31495	80 mm	20
31496	100 mm	20

FACADE STAINLESS STEEL PUTTY KNIFE

FESTA

INOX



No.	specification	
31552	400 mm	10
31553	600 mm	10

STAINLESS STEEL PAINT SCRAPER

FESTA

INOX



No.	specification	
31497	63 x 195 mm	12

STAINLESS STEEL WALLPAPER KNIFE

FESTA

INOX



No.	specification	
31503	150 mm	12

PAINT SCRAPER

MADE IN
EU

No.	specification	
31501	100 mm	30
31502	spare edge	1

DRYWALL PLASTIC PUTTY KNIFE

PLASTIC





No.	specification	
34308	50 mm	20
34307	80 mm	12
34306	100 mm	10
34305	150 mm	12

SET OF PUTTY KNIVES

FESTA

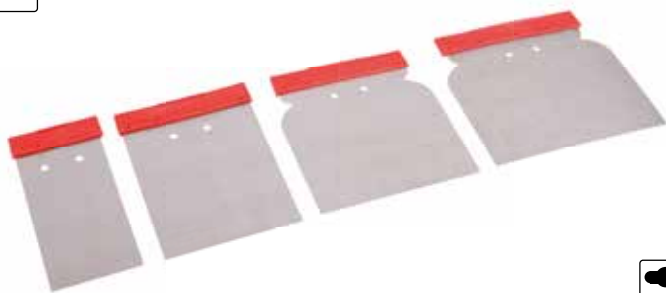
4x



No.	specification	
31452	stainless 50, 80, 100, 120 mm	10
31453	metal 50, 80, 100, 120 mm	10

SET OF PUTTY KNIVES, PLASTIC

FESTA

PLASTIC

4x



No.	specification	
31454	50, 80, 100, 120 mm	12

STEEL TROWEL

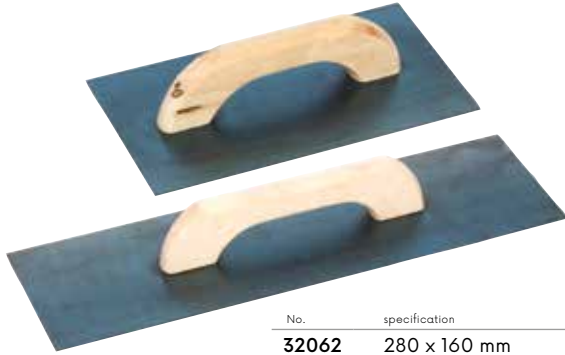

No.	specification	
32062	280 x 160 mm	10
32076	400 x 100 mm	36
32060	500 x 140 mm	5

STEEL TROWEL



No.	specification	
32064	500 x 90 mm	5
32066	550 x 140 mm	5

PLASTERERS TROWEL



No.	specification	
32015	160 x 130 mm	10
32014	180 x 130 mm	10
32016	200 x 140 mm	10

PLASTERERS TROWEL



No.	specification	
32001	160 x 110 mm	10
32002	160 x 130 mm	10
32003	180 x 130 mm	10
32013	200 x 140 mm	10

PLASTERERS TROWEL



No.	specification	
32018	160 x 110 mm	10

PLASTERERS TROWEL



No.	specification	
32024	140 x 80 mm	12

CAT TONGUE TROWEL



No.	specification	
32020	140 x 65 mm	12
32021	140 x 40 mm	12

PLASTERERS TROWEL





No.	specification	
32026	140 x 85 mm	12

PUTTY KNIFE



FESTA®



No.	specification		No.	specification	
32161	30 mm	10	32171	90 mm	10
32162	40 mm	10	32166	100 mm	10
32163	50 mm	10	32172	110 mm	10
32164	60 mm	10	32167	120 mm	10
32169	70 mm	10	32168	140 mm	10
32165	80 mm	10			

PUTTY KNIFE



No.	specification		No.	specification	
32176	30 mm	12	32216	80 mm	12
32186	40 mm	12	32226	100 mm	12
32196	50 mm	12	32234	125 mm	12
32206	60 mm	12			

STAINLESS STEEL SCRAPER

FESTA®

INOX



No.	width	length	
32174	100 mm	500 mm	1

SET OF PUTTY KNIVES

3x

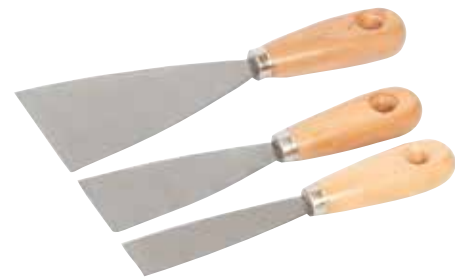

No.	specification	
32240	30, 50, 80 mm	10



PUTTY KNIFE



No.	specification	
31601	180 mm - equals	1
31602	NEW 180mm A1	1
31603	NEW 180mm A2	1
31641	180 mm - e4	1

PUTTY KNIFE

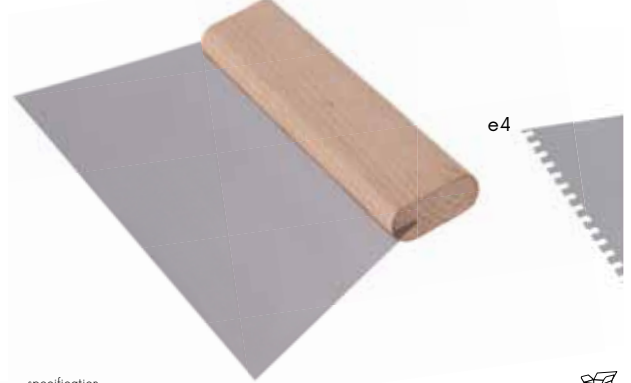

No.	specification	
31655	250 mm - e4	1
31651	250 mm - straight	1

DENTED SPREADER WITH TEETH

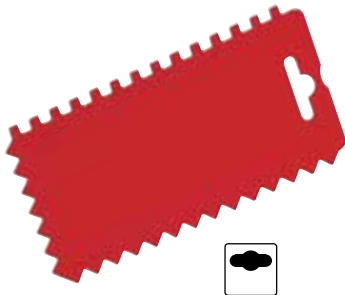

No.	specification	
37101	150 x 80 mm	100
37111	170 x 115 mm	100

DENTED SPREADER



No.	specification	
37031	tooth - 4 x 6 mm	1
37041	tooth - 6 x 6 mm	1
37051	straight	1

PLASTERERS TROWEL



No.	specification	
32022	140 x 80 mm	12
32023	125 x 40 mm	12

JOINT TROWEL ONE-SIDED

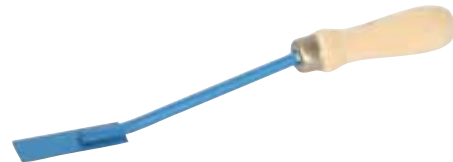

No.	specification	
32040	10 mm	20
32041	12 mm	20
32042	15 mm	20
32043	18 mm	20
32044	20 mm	20

JOINT TROWEL DOUBLE-SIDED

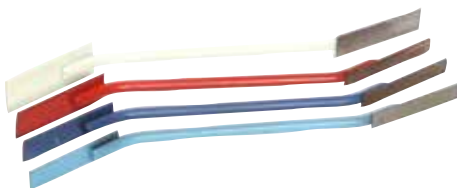

No.	specification	
32050	10 12 mm	50
32051	10 15 mm	50
32052	10 18 mm	50
32053	15 20 mm	50

BUILDING CARVER FOR AERATED CONCRETE



No.	specification	
32037	600 mm	1

BAR TROWEL FOR AERATED CONCRETE

FESTA®



· poplar

MOQ
2

No.	specification
32317	450 x 95 mm



FINE BAR TROWEL FOR AERATED CONCRETE

FESTA®



· poplar

MOQ
2

No.	specification
32312	450 x 95 mm



BAR TROWEL FOR AERATED CONCRETE

FESTA®



· poplar

MOQ
2

No.	specification
32337	260 x 95 mm



BAR TROWEL FOR BRISOLITE

FESTA®



· poplar

MOQ
2

No.	specification
32327	230 x 145 mm



BAR TROWEL



MOQ
2

No.	specification	
32314	400 x 180 mm	2

BAR TROWEL



MOQ
2

No.	specification	
32329	270 x 130 mm	2

BAR TROWEL WITH HOLES



MOQ
2

No.	specification	
33168	380 x 160 mm	2

BAR TROWEL



MOQ
2

No.	specification	
32320	400 x 180 mm	2

SANDING TROWEL



MOQ
2

No.	specification	
32418	400 x 180 mm asperity 16	2
32421	400 x 180 mm asperity 16 sanding paper	10

SANDING TROWEL



MOQ
2

No.	specification	
32318	400 x 180 mm	2
32319	500 x 250 mm	2
32321	400 x 180 mm asperity 16 sanding paper	10
32322	500 x 250 mm asperity 16 sanding paper	10

SANDING TROWEL PLASTIC



MOQ
2

No.	specification	
32324	270 x 130 mm asperity 16	2
32323	270 x 130 mm asperity 16 sanding paper	10

SANDING TROWEL



MOQ
2

No.	specification	
32330	400 x 180 mm	2
32331	270 x 130 mm	2

BAR TROWEL

Zn

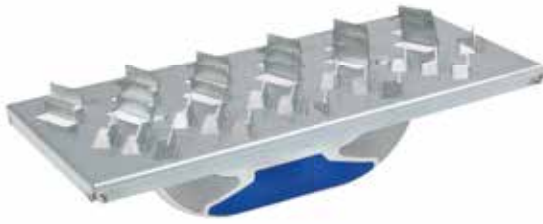

MOQ
2

No.	specification
32328	285 x 145 mm

20

BAR TROWEL



MOQ
2

No.	specification
32325	225 x 105 mm

2

GRILL BAR TROWEL

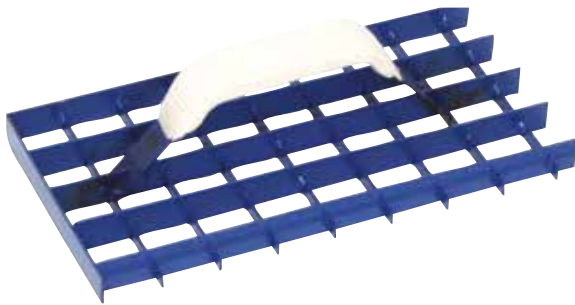

MOQ
2

No.	specification
32316	280 x 150 mm

20

GRILL BAR TROWEL NOTCHED

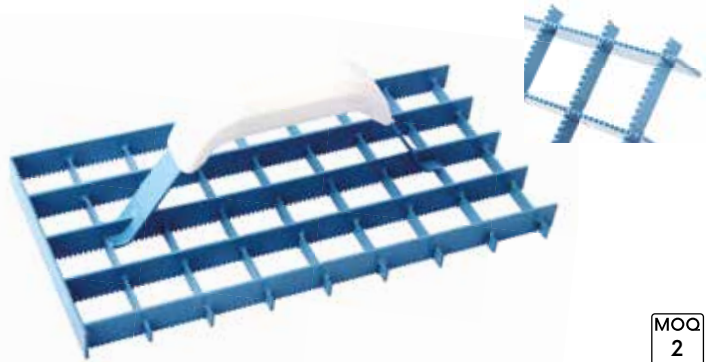

MOQ
2

No.	specification
32335	290 x 145 mm

2

GRILL BAR TROWEL

ALU



· 8 edges

MOQ
2

No.	specification
32326	450 x 90 mm

20

BAR TROWEL PLASTIC



· 6 edges

MOQ
2

No.	specification
32315	270 x 90 mm

30

TROWEL PLASTIC



No.	specification
34027	400 x 180 mm

20

FLOAT PLASTIC



No.	specification	
30003	270 x 125 mm	28
30004	235 x 115 mm	35
30005	210 x 115 mm	38
30007	210 x 60 mm	44

28
35
38
44

WOODEN TROWEL

FESTA



· linden wood

No.	specification	
34005	400 x 145 mm	40
34007	290 x 145 mm	20

WOODEN TROWEL



· poplar wood

No.	specification	
34006	400 x 145 mm	40

TROWEL ABS



No.	specification	
34041	280 x 140 - 2 mm	10
34051	280 x 140 - 3 mm	10
34053	280 x 140 - 3 mm teeth - e6	10

MASON STAFF



No.	specification	
15889	980 x 380 mm butt Ø 32 mm	1

MASON STAFF - RUBBER



No.	specification	
15886	450 mm butt Ø 23 mm	48
15887	600 mm butt Ø 23 mm	48
15888	750 mm butt Ø 23 mm	32

MASON STAFF



No.	specification	
15885	100 x 800 mm butt Ø 32 mm	1

POLYURETHAN FLOAT

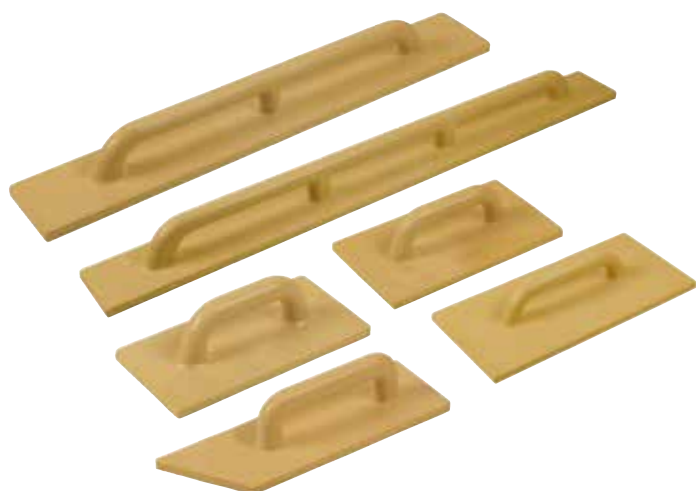

No.	specification		No.	specification	
34122	120 x 240 mm	50	34154	220 x 420 mm	15
34132	140 x 280 mm	40	34155	240 x 480 mm	15
34142	180 x 320 mm	25	34156	280 x 500 mm	10
34152	200 x 360 mm	20	34157	330 x 330 mm	5
34121	80 x 260 mm chamfered	50	34158	120 x 800 mm	5
34153	100 x 400 mm	30	34159	120 x 1000 mm	5
			34160	120 x 1200 mm	5

POLYSTYREN FLOAT

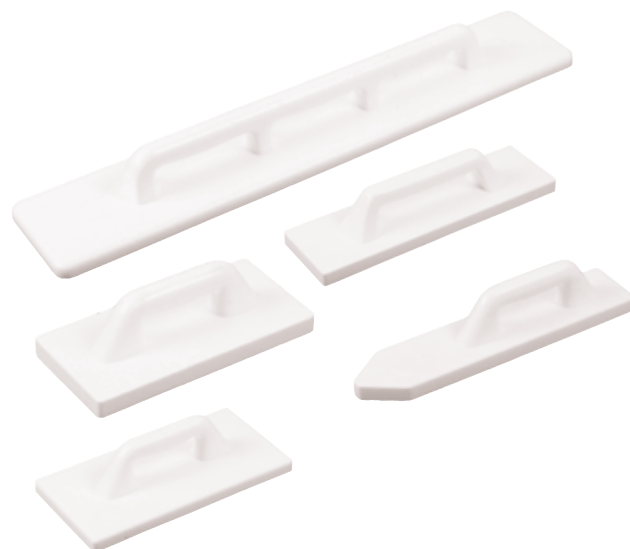

No.	specification		No.	specification	
34101	80 x 350 mm chamfered	10			
34061	130 x 270 mm	10			
34111	170 x 320 mm	10			
34071	130 x 450 mm	10			
34081	140 x 750 mm	10			
34091	140 x 900 mm	5			

POLYURETHAN FLOAT



No.	specification	
34115	140 x 280 mm	36
34116	180 x 320 mm	36
34117	200 x 360 mm	24
34118	220 x 420 mm	24
34119	240 x 480 mm	24

SANDING MASH HOLDER



No.	specification	
34301	230 x 105 mm	1
34304	235 x 80 mm	1

SANDING MASH HOLDER



No.	specification	
34200	210 x 115 mm	30
34201	240 x 105 mm	50
34202	240 x 80 mm	50

SANDING MASH HOLDER

ALU



· handle 52030

No.	specification	
34203	230 x 80 mm aluminium	1
52030	telescopic pole	12

SANDING MESH SET

10x



No.	specification	
34271	115 x 290 mm zrn. 120	80
34272	115 x 290 mm zrn. 100	80
34273	115 x 290 mm zrn. 80	80
34274	93 x 290 mm zrn. 120	80
34275	93 x 290 mm zrn. 100	80
34276	93 x 290 mm zrn. 80	80

SANDING MESH SET

3x





No.	specification	
34280	115 x 290 mm zrn. 120	20
34281	115 x 290 mm zrn. 100	20
34282	115 x 290 mm zrn. 80	20
34283	93 x 290 mm zrn. 120	20
34284	93 x 290 mm zrn. 100	20
34285	93 x 290 mm zrn. 80	20

MATERIAL SURFACE	CONCRETE		PLASTER			STICK AND JOINTING MATERIAL	FACADE STICK	APPLICATION
	ROUGH	SCREEDING	CORE	SOFT INWARD	SOFT YONG			
BLACK FELT (BROWN, GREY)				••••		••		grading of the soft plaster, using for the bigger corn of the plaster
WHITE FELT				••••	••••	••••		grading of the soft plaster, using for the smaller corn of the plaster
SOFT FOAM				••••	••••	••••		elimination of the free sand, for the soft stucco
ROUNG FOAM				••••	••••	••••		elimination of the free sand, for the rough stucco
RASTER FOAM				••••	••••	••••		elimination of the free sand, thanks to the raster gives better capture of the rough stucco
SEA SPONGE					•••		••••	washing of the jointing material, for the thin joint, elimination of the sand
HYDRO SPONGE SOFT, ROUNG					•		••••	washing of the jointing material, for the thick joint, elimination of the sand
SPONGE				••	••••	••	••••	washing of the jointing material, assurance of the soft plaster
MICRO RUBBER							••••	crowd the jointing material to the joint
RUBBER FOAM							••••	crowd the jointing material to the joint
MIRELON		••••	••					process with the concrete, defray of the core
DUREN				••••	••	••••		match of the soft plaster
WOOD	••••	••••	••••					process with the concrete, defray of the core
STEEL PLATE	••	••••		••		••••	••	smoothing of the concrete, inaccessible places
POLYSTYRENE	•••	••••	••	••		••		process with the concrete, defray of the core
POLYURETHAN	••••	••••	••••					process with the concrete, defray of the core
ABS		••		••••	••••	••••	••••	combed and twisted stucco, spreading of the soft plaster, scuntion
STAINLESS SMOOTH				••••	••••	••••	••••	spreading of the soft plaster, spreading of the facade stick
STAINLESS TOOTHED							••••	spreading of the stick for facings and pavings
GRINDING FLOAT FOR POLYSTYRENE, PLASTIC			••				••••	grinding of the polystyrene, grinding of the cement stick, concrete, walling, plaster
GRINDING FLOAT FOR POLYSTYRENE, POLYWOOD			••				••••	grinding of the facade polystyrene



FLOAT WITH FELT



No.	specification		No.	specification	
34400	280 x 140 x 8 mm	15	34450	220 x 130 x 8 mm	15
34415	250 x 130 x 8 mm	15	34445	220 x 70 x 8 mm	20



REPLACEMENT FELT



No.	specification		No.	specification	
34241	280 x 140 x 8 mm	1	34460	220 x 130 x 8 mm	1
34223	250 x 130 x 8 mm	1	34475	220 x 70 x 8 mm	1



FLOAT WITH FELT



No.	specification		No.	specification	
34401	280 x 140 x 10 mm	15	34451	220 x 130 x 10 mm	15
34416	250 x 130 x 10 mm	15	34446	220 x 70 x 10 mm	20

REPLACEMENT FELT



No.	specification		No.	specification	
34243	280 x 140 x 10 mm	1	34461	220 x 130 x 10 mm	1
34221	250 x 130 x 10 mm	1	34476	220 x 70 x 10 mm	1

FLOAT WITH SPONGE



No.	specification	
34441	280 x 140 x 12 mm	15
34440	250 x 130 x 12 mm	15



REPLACEMENT SPONGE



No.	specification	
34473	280 x 140 x 12 mm	1
34472	250 x 130 x 12 mm	1



FLOAT WITH SOFT SPONGE



No.	specification		No.	specification	
34405	280 x 140 x 18 mm	15	34480	280 x 140 x 12 mm	15
34420	250 x 130 x 18 mm	15	34481	250 x 130 x 12 mm	15
34454	220 x 130 x 18 mm	15	34482	220 x 130 x 12 mm	15
34449	220 x 70 x 18 mm	20			

REPLACEMENT SOFT SPONGE



No.	specification		No.	specification	
34262	280 x 140 x 18 mm	1	34290	280 x 140 x 12 mm	1
34227	250 x 130 x 18 mm	1	34291	250 x 130 x 12 mm	1
34465	220 x 130 x 18 mm	1	34292	220 x 130 x 12 mm	1
34474	220 x 70 x 18 mm	1			

FLOAT WITH EXTRA SOFT SPONGE



No.	specification	
34443	280 x 140 x 12 mm	15
34442	250 x 130 x 12 mm	15

REPLACEMENT EXTRA SOFT SPONGE



No.	specification	
34471	280 x 140 x 12 mm	1
34470	250 x 130 x 12 mm	1

FLOAT WITH SOFT MOLITAN



No.	specification		No.	specification	
34404	280 x 140 x 30 mm	10	34419	250 x 130 x 20 mm	10
34485	280 x 130 x 20 mm	10	34453	220 x 130 x 20 mm	10
34486	250 x 130 x 30 mm	10	34447	220 x 70 x 20 mm	10

REPLACEMENT SOFT MOLITAN



No.	specification		No.	specification	
34251	280 x 140 x 30 mm	1	34224	250 x 130 x 20 mm	1
34295	280 x 130 x 20 mm	1	34464	220 x 130 x 20 mm	1
34296	250 x 130 x 30 mm	1	34477	220 x 70 x 20 mm	1

FLOAT WITH MOLITAN



No.	specification	
34409	280 x 140 x 30 mm	10
34425	250 x 130 x 20 mm	10

REPLACEMENT MOLITAN



No.	specification	
34253	280 x 140 x 30 mm	1
34225	250 x 130 x 20 mm	1

FLOAT WITH MOLITAN



No.	specification	
34410	280 x 140 x 30 mm	10
34426	250 x 130 x 20 mm	10

REPLACEMENT MOLITAN



No.	specification	
34261	280 x 140 x 30 mm	1
34226	250 x 130 x 20 mm	1

FLOAT WITH SPONGE



No.	specification	
34406	280 x 140 x 30 mm	10
34421	250 x 130 x 30 mm	10
34455	220 x 130 x 30 mm	10

REPLACEMENT SPONGE



No.	specification	
34265	280 x 140 x 30 mm	1
34228	250 x 130 x 30 mm	1
34466	220 x 130 x 30 mm	1

FLOAT WITH SPONGE



No.	specification	
34413	280 x 140 x 30 mm	10
34428	250 x 130 x 30 mm	10

REPLACEMENT SPONGE



No.	specification	
34264	280 x 140 x 30 mm	1
34233	250 x 130 x 30 mm	1

FLOAT WITH SPONGE

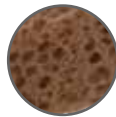

No.	specification	
34412	280 x 140 x 30 mm	10
34424	250 x 130 x 30 mm	10
34458	220 x 130 x 30 mm	10

REPLACEMENT SPONGE

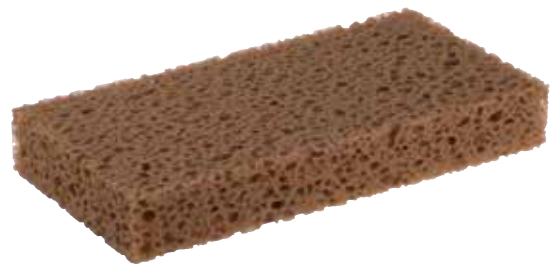

No.	specification	
34238	280 x 140 x 30 mm	1
34236	250 x 130 x 30 mm	1
34469	220 x 130 x 30 mm	1

FLOAT WITH SPONGE



No.	specification	
34490	280 x 140 x 30 mm	10
34491	250 x 130 x 30 mm	10

REPLACEMENT SPONGE

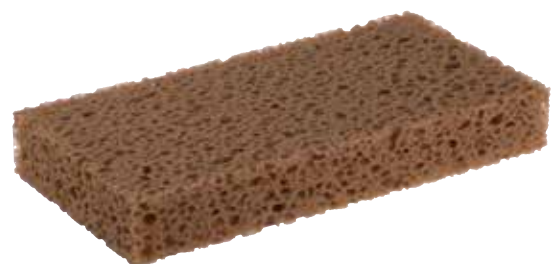

No.	specification	
34298	280 x 140 x 30 mm	1
34299	250 x 130 x 30 mm	1

FLOAT WITH SPONGE

FESTA®



No.	specification	
34411	280 x 140 x 30 mm	10
34423	250 x 130 x 30 mm	10
34457	220 x 130 x 30 mm	10

REPLACEMENT SPONGE



No.	specification	
34237	280 x 140 x 30 mm	1
34235	250 x 130 x 30 mm	1
34468	220 x 130 x 30 mm	1

FLOAT WITH RUBBER

FESTA®



No.	specification	
34402	280 x 140 x 10 mm	15
34417	250 x 130 x 10 mm	15
34452	220 x 130 x 10 mm	15

REPLACEMENT RUBBER



No.	specification	
34231	280 x 140 x 10 mm	1
34222	250 x 130 x 10 mm	1
34462	220 x 130 x 10 mm	1

FLOAT WITH MICRORUBBER

FESTA®



No.	specification	
34403	280 x 140 x 8 mm	15
34418	250 x 130 x 8 mm	15
34496	220 x 130 x 8 mm	15

REPLACEMENT MICRORUBBER



No.	specification	
34232	280 x 140 x 8 mm	1
34230	250 x 130 x 8 mm	1
34463	220 x 130 x 8 mm	1

FLOAT WITH DUREN

FESTA®



No.	specification	
34407	280 x 140 x 20 mm	10
34422	250 x 130 x 20 mm	10
34456	220 x 130 x 20 mm	10
34448	220 x 70 x 20 mm	10

REPLACEMENT DUREN



No.	specification	
34266	280 x 140 x 20 mm	1
34267	250 x 130 x 20 mm	1
34467	220 x 130 x 20 mm	1
34478	220 x 70 x 20 mm	1

FLOAT WITH RUVEN

FESTA®



No.	specification	
34414	280 x 140 x 20 mm	10
34429	250 x 130 x 20 mm	10
34459	220 x 130 x 20 mm	10
34479	220 x 70 x 20 mm	10

REPLACEMENT RUVEN



No.	specification	
34167	280 x 140 x 20 mm	1
34168	250 x 130 x 20 mm	1

FLOAT

FESTA®



No.	specification	
34033	240 x 95 mm	5

FLOAT PLASTIC

FESTA®



No.	specification	
30003	270 x 125 mm	28
30004	235 x 115 mm	35
30005	210 x 115 mm	38
30007	210 x 60 mm	44

FLOAT WITH SPONGE 90°

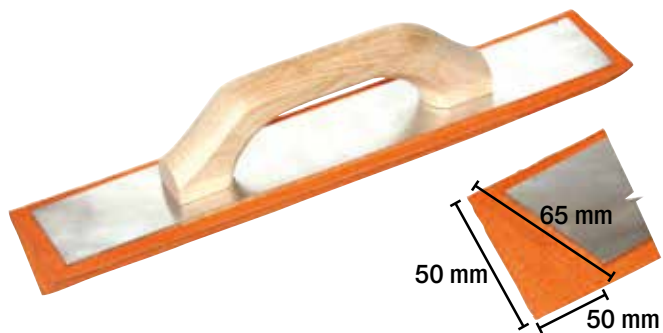

No.	specification	
34500	350 mm	6

DIPPER STAINLESS STEEL



INOX



No.	specification	
32285	Ø 180 mm	1

DIPPER ZN COATED



Zn



No.	specification	
32265	Ø 180 mm	10

DIPPER



No.	specification	
32273	Ø 160 mm	10
32285	Ø 180 mm	10
32293	Ø 215 mm	10

DIPPER PLASTIC



No.	specification	
32270	Ø 160 mm	1

DIPPER



No.	specification	
32302	Ø 180 mm	1
32313	Ø 215 mm	1
32301	Ø 235 mm	1

· recommended pole handle 61215

DIPPER FOR SHOVEL BUTT

· recommended pole handle 61200, 61201



No.	specification	
32268	Ø 215 mm	1
32269	Ø 235 mm	1
32296	Ø 215 mm	1

DIPPER WITH BUTT



MOQ
3

No.	specification	
32295	Ø 180 mm length of butt 160 cm	3
32297	Ø 215 mm length of butt 160 cm	3
32298	Ø 235 mm length of butt 160 cm	3

CONCRETE MIXER



No.	specification	
60100	concrete mixer 295 x 150 mm	24
61169	concrete mixer with butt 160 cm	3
61218	butt 160 cm	5

ELECTRIC MIXER FOR BUILDING MIXTURES

FESTA®

NEW

Zn

CE



Input	1800 W
Voltage / frequency	230 V / 50 Hz
Gears	2
1st gear (idle speed)	0 - 450 ot./min.
2nd gear (idle speed)	0 - 790 ot./min.
Overload protection	Ano
Mixing basket diameter	100 mm
Broom length	570 mm
Weight	5,6 kg



No.	specification	
35311	stirrer	1
35318	spare carbon	1
35319	spare stirrers - pair (L + R)	1

ELECTRIC MIXER 850W

M14

Zn

CE



Power input	850 W
Voltage	230 V / 50 Hz
Number of gears	1
No-Load-speed	0 - 500 ot./min.
No-Load-speed	-
Protection	Ano/ Yes
Thread	M 14
Mixing paddle	120 mm
Length of mixing paddle	600 mm
Weight	3,7 kg



No.	specification	
35300		1
35316	spare carbon	1

ELECTRIC MIXER 1600 W

M14

Zn

CE



Power input	1600 W
Voltage	230 V / 50 Hz
Number of gears	2
No-Load-speed	0 - 480 ot./min.
No-Load-speed	0 - 800 ot./min.
Protection	Ano/ Yes
Thread	M 14
Mixing paddle	140 mm
Length of mixing paddle	600 mm
Weight	4,7 kg



No.	specification	
35310		1
35317	spare carbon	1

SPIRAL MIXER CLOCKWISE

Zn

M14



No.	specification	
35059	M14 Ø 90 x 550 mm	24
35085	M14 Ø 120 x 600 mm	12
35086	M14 Ø 140 x 600 mm	12
35087	M14 Ø 160 x 600 mm	12



SPIRAL MIXER COUNTERCLOCKWISE

Zn

M14



No.	specification	
35091	M14 Ø 120 x 600 mm	12
35092	M14 Ø 140 x 600 mm	12
35093	M14 Ø 160 x 600 mm	12



SPIRAL MIXER



Zn



No.	specification	
35038	Ø 80 x 500 mm	24
35058	Ø 100 x 500 mm	24
35023	Ø 120 x 500 mm	24

SPIRAL MIXER

SDS+

Zn



No.	specification	
35094	Ø 80 x 500 mm	24
35095	Ø 100 x 500 mm	24
35096	Ø 120 x 500 mm	24

SPIRAL MIXER WITH LONGER SPIRAL



Zn

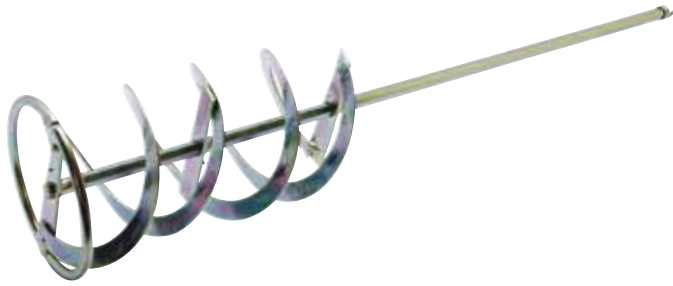

Spiral mixer paddle with 2 blades - for the full mixture of the tile cement, jointing materials, sizing material, renders, screed, blinding materials, smoothing compounds.

No.	specification	
35013	Ø 80 x 500 mm	24
35006	Ø 100 x 500 mm	24
35007	Ø 120 x 500 mm	24

SPIRAL MIXER WITH LONGER SPIRAL

SDS+

Zn



Spiral mixer paddle with 2 blades - for the full mixture of the tile cement, jointing materials, sizing material, renders, screed, blinding materials, smoothing compounds.

No.	specification	
35012	Ø 100 x 500 mm	24

SPIRAL MIXER



Zn



Spiral mixer paddle with 2 blades - for the full mixture of the tile cement, jointing materials, sizing material, renders, screed, blinding materials, smoothing compounds.

No.	specification	
35069	Ø 60 x 500 mm	50
35078	Ø 80 x 500 mm	24
35081	Ø 100 x 500 mm	24

SPIRAL MIXER

SDS+

Zn



Spiral mixer paddle with 2 blades - for the full mixture of the tile cement, jointing materials, sizing material, renders, screed, blinding materials, smoothing compounds.

No.	specification	
35070	Ø 60 x 500 mm	50
35079	Ø 80 x 500 mm	24
35082	Ø 100 x 500 mm	24

SPIRAL MIXER



Zn



Spiral mixer paddle with 2 blades - for the full mixture of the tile cement, jointing materials, sizing material, renders, screed, blinding materials, smoothing compounds.

No.	specification	
35048	Ø 70 x 500 mm	24
35068	Ø 90 x 500 mm	24

SPIRAL MIXER



Zn



Appropriate for high viscose and adhesive materials, such as construction adhesives and cement, plaster, screed loor cover etc. The material flows from the button to level.

No.	specification	
35021	Ø 100 x 500 mm	24

MIXER



Zn



Cage mixed paddle – for materials where air intake is undesirable. For fluid smoothing compounds, blinding materials, sealing material, glue.

No.	specification	
35015	Ø 100 x 500 mm	20

PROPELLER MIXER



Zn



Propeller mixer paddle – for fluid materials, paints, wall and dispersed glues for sticking wallpapers, tile glue.

No.	specification	
35011	Ø 80 x 500 mm	50

SPIRAL MIXER



Zn



Arcaded mixer paddle with a ring - for the full mixture of wall paints, dispersed paints, glues, flooding compounds, paints, asphalted bitumen, coatings.

No.	specification	
35125	Ø 60 x 400 mm	40
35126	Ø 80 x 400 mm	40
35127	Ø 100 x 600 mm	20

SPIRAL MIXER LACQUARED



Arcaded mixer paddle with a ring - for the full mixture of wall paints, dispersed paints, glues, flooding compounds, paints, asphalted bitumen, coatings.

No.	specification	
35103	Ø 60 x 400 mm	40
35113	Ø 80 x 400 mm	40
35123	Ø 100 x 600 mm	20

EXTENSION CABLE WITH REEL



- Extension cable with 25 m reel - IP20
- H05VV - F 3G 1.5mm², - Equipped with a thermal fuse
- Welding power: 1000 W max.
- Output power: 3000 W max.
- 4 grounded sockets with child lock.



No.	specification	
37760	4 socket, length 25 m, IP 20, 1,5 mm ²	2
37761	4 socket, length 50 m, IP 20, 1,5 mm ²	2

EXTENSION CABLE



No.	specification	
37730	max. 3680 W length 10 m, 1,5 mm ²	8
37731	max. 3680 W length 20 m, 1,5 mm ²	4

ELECTRIC HEATER



voltage	230V ~50Hz
output	3300W
current load	14.5A
set up performance	30/1650/3300W
temperature range	5-40°C
protection	IP24
specification	27 x 25.5 x 40cm
weight	4.8 kg

- fast and efficient heating of cellars, workshops, shops, party tents, greenhouses etc.
- does not consume oxygen
- safe operation, continuous power control, room thermostat, fan.
- stainless steel heating element
- possibility of summer use for ventilation without heating
- low noise
- high-quality processing, materials, robust steel construction, easy and safe handling, long service life

No. specification
35833 3,3 kW



GAS HEATER



gas	G30-I3B/P
gas pressure	0.7bar
voltage	230V 50Hz
engine output	25W
max. gas consumption	1.11 Kg/h
max. heat output	15KW
max. volume of hot air	300m ³ /h

- fast and efficient heating during construction works, workshops
- it consumes oxygen!
- direct air heating with forced circulation - rapid heat gain
- safe operation, smooth power regulation
- thermostat and safety valve against overheating and leakage
- accessories included - controller and inlet gas hose
- high-quality processing, materials, robust steel construction, easy and safe handling with a long service life

No. specification
35845 15 kW



GAS HEATER



gas	g30-i3b/p
gas pressure	1.5bar
voltage	230v 50hz
engine output	70w
max. gas consumption	2.2kg/h
max. heat output	30kw
max. volume of hot air	750m ³ /h

- fast and efficient heating during construction works, workshops
- it consumes oxygen!
- direct air heating with forced circulation - rapid heat gain
- safe operation, smooth power regulation
- thermostat and safety valve against overheating and leakage
- accessories included - controller and inlet gas hose
- high-quality processing, materials, robust steel construction, easy and safe handling with a long service life

No. specification
35850 30 kW





PROFESSIONAL BUILDING MIXERS

Lescha

Building mixers for demanding professional use
 Gear wreath made of cast iron with patented fastening
 Double bearing seats on the drum
 Patented protection insulation, quality protection according to DIN EN ISO 9001
 Adjustable clearance teeth
 High quality finish
 Specially designed shape drum
 Protection splash-proof IP 45
 Supplied in 230V and 400V

BUILDING MIXER



Lescha

MADE IN
EU

No.	specification	
35500	Star 150 - 125 230 V leg break	1

BUILDING MIXER



Lescha

MADE IN
EU

No.	specification	
35502	EUROMIX 125 230 V	1
35503	EUROMIX 125 400 V	1

BUILDING MIXER



Lescha

MADE IN
EU

No.	specification	
35501	BX 135 - 125 230 V	1

BUILDING MIXER



Lescha

MADE IN
EU

No.	specification	
35504	ABM 135 230 V leg break	1

BUILDING MIXER



Lescha

MADE IN
EU

No.	specification	
35505	SM 145 S - 140 230 V	1
35506	SM 145 S - 140 400 V	1
35507	SM 145 S - 140 230 V leg break	1
35508	SM 145 S - 140 400 V leg break	1

BUILDING MIXER



Lescha

MADE IN
EU

No.	specification	
35510	SM 165 S - 160 230 V leg break	1
35511	SM 165 S - 160 400 V leg break	1
35512	SM 165 S - 160 G petrol	1

BUILDING MIXER



Lescha



No.	specification		
35514	SM 185 S - 180 230 V leg break	1	
35515	SM 185 S - 180 400 V leg break	1	

BUILDING MIXER



Lescha



No.	specification		
35516	S 180 HR - 180 230 V leg break	1	
35517	S 180 HR - 180 400 V leg break	1	

BUILDING MIXER



Lescha



No.	specification		
35524	LB 354 230 V 1,5 kW		1
35525	LB 354 400 V 1,5 kW		1
35527	LB 354 Honda G200		1
35532	LB 404 230 V, 1,5 kW		1
35533	LB 404 400 V, 1,5 kW		1
35539	LB 484 Robin EH17B		1
35540	LB 484 Honda GX160LX		1
35542	AT 480 400 V, 1,2 kW		1

BUILDING MIXER



Lescha



No.	specification		
35552	LHB 1000 400 V		1
35553	LHB 1000 HATZ Diesel		1
35555	LHB 1200 400 V		1

BUILDING MIXER



Lescha



No.	specification		
35518	S 230 HR - 230 230 V leg break		1
35519	S 230 HR - 230 400 V leg break		1



BUILDING MIXER



130 L

specification

volume of drum	130 l
drum speed	26±Min ⁻¹
power	700 W
voltage	230 V / 50 Hz
degree of protection	IP44
material of chaplet	litinový cast iron
specification	length 1170 mm width 650 mm výška/ height 1280 mm
weight	53 kg

165 L

specification

volume of drum	165 l
drum speed	23±Min ⁻¹
power	900 W
voltage	230 V / 50 Hz
degree of protection	IP44
material of chaplet	litinový cast iron
specification	length 1295 mm width 735 mm výška/ height 1440 mm
weight	70 kg

No.	specification				
37500	MIX 130Zk	230 V	unassembled		1
37501	MIX 130Z	230 V	assembled		1
37505	MK 165Bk	230 V	unassembled		1
37506	MK 165B	230 V	assembled		1

BUILDING MIXER



• specially made shoulder-blade 4 mm



• sgood quality thrust bearing



• switch with safety shield



• plastic shield of drive, cast iron wreath

125 L

specification	
volume of drum	125 l
drum speed	26±Min ⁻¹
power	550 W
voltage	230 V / 50 Hz
degree of protection	IP44
material of chaplet	litinový cast iron
specification	length 1102 mm
	width 690 mm
	výška/ hight 1310 mm
weight	52,5 kg

No.	specification		
37509	126 l 230 V	assembled	1
37510	126 l 230 V	unassembled	1

142 L

specification	
volume of drum	142 l
drum speed	26±Min ⁻¹
power	650 W
voltage	230 V / 50 Hz
degree of protection	IP44
material of chaplet	litinový cast iron
specification	length 1164 mm
	width 690 mm
	výška/ hight 1293 mm
weight	54 kg

No.	specification		
37511	142 l 230 V	unassembled	1
37512	142 l 230 V	assembled	1

162 L

specification	
volume of drum	162 l
drum speed	26±Min ⁻¹
power	650 W
voltage	230 V / 50 Hz
degree of protection	IP44
material of chaplet	litinový cast iron
specification	length 1180 mm
	width 710 mm
	výška/ hight 1310 mm
weight	56 kg

No.	specification		
37515	162 L 230 V	unassembled	1
37516	162 L 230 V	assembled	1

180 L

specification	
volume of drum	180 l
drum speed	26±Min ⁻¹
power	850 W
voltage	230 V / 50 Hz
degree of protection	IP44
material of chaplet	litinový cast iron
specification	length 1164 mm
	width 690 mm
	výška/ hight 1368 mm
weight	58 kg

No.	specification		
37517	180 l 230 V	unassembled	1
37518	180 l 230 V	assembled	1

CONSTRUCTON DEBRIS CHUTE

Lescha
MADE IN
EU



No.	špecifikácia	
35603	drop basic diameter 50 cm, length 110 cm PE (HDPE)	1
35604	PE building debris (HDPE)	1
35605	supporting frame for hopper conformity of building rubble	1



WHEELBARROW



No.	specification	
37530	60 l, Ø 38 cm solid tyre	1
37532	60 l, Ø 40 cm pneumatic tyre	1

WHEELBARROW GALVANIZED



Zn



No.	specification	
37527	80 l, Ø 40 cm pneumatic tyre	1
37533	80 l, Ø 38 cm solid tyre	1

WHEELBARROW HULL BLACK



No.	specification	
37539	60 l	1

WHEELBARROW HULL GALVANIZED



Zn



No.	specification	
37541	80 l	1

SPARE WHEELS



No.	specification		
48729	typ AA 400	pneumatic tyre	1
48730	typ AA 380	solid tyre	1
48731	typ AA 380	solid tyre (Slovakia)	1

BRICK HOLDER



No.	specification	
36310		5

WHEELBARROW WITH THREE WHEELS



No.	specification		
37564	60 l		1

CURB HOLDER

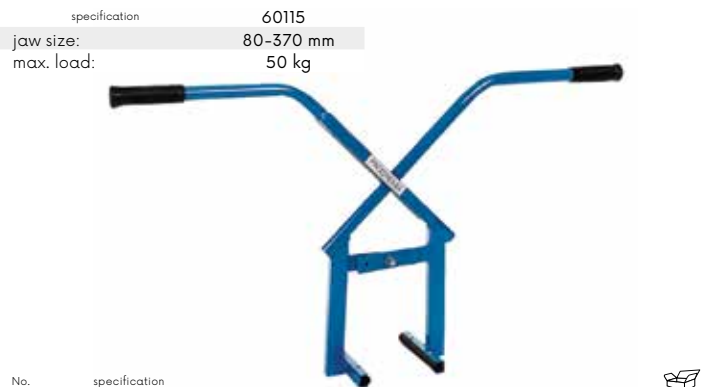

specification 60115
 jaw size: 80-370 mm
 max. load: 50 kg

No.	specification	
60115	PRO 040	1

CURB HOLDER



specification 60116
 jaw size: 750-1000 mm
 max. load: 120 kg

No.	specification	
60116	PRO 041	1

CURB HOLDER



specification 60117 60118
 jaw size: 500-1000 mm 0-500 mm
 max. load: 150 kg 150 kg

No.	specification	
60117	PRO 042	1
60118	PRO 043	1

STRAIGHT LINE STONE HAMMER



specification	60121	60123
height	200 mm	200 mm
width	70 mm	70 mm
length	870 mm	450 mm
weight	2,5 kg	2,2 kg

No.	specification	
60121	870 mm	1
60123	450 mm	1

PAD



No.	specification	
37166	D10 basic	25

HAND TRUCK



No.	specification	load capacity	
48719	wheel 260 mm bantam	250 kg	1

GOAT ON WOOD CUTTING

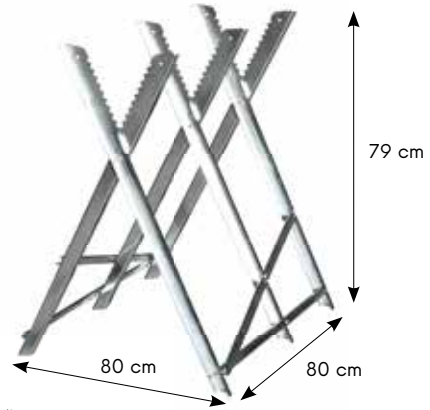

No.	specification	
37570	max. 150 kg	1

FOLDABLE SAW HORSE

2x

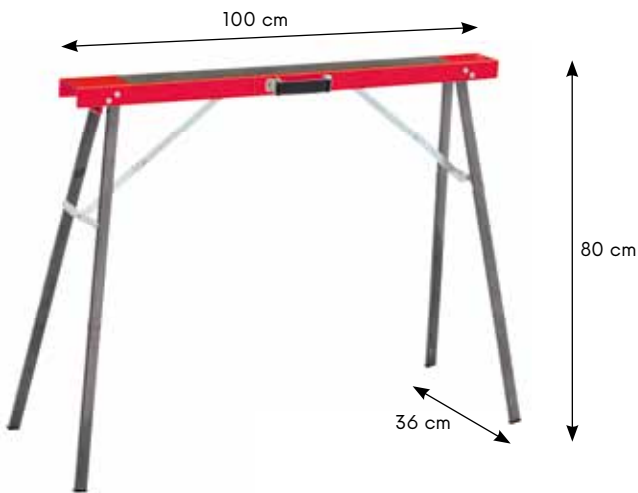

· max. load capacity 125 kg

No.	specification	
37549	pair	1

PLASTIC SAW HORSE

2x



· max. load capacity 150 kg (300 kg in pair)

No.	specification	
37560	pair	1

ADJUSTABLE SAW HORSE

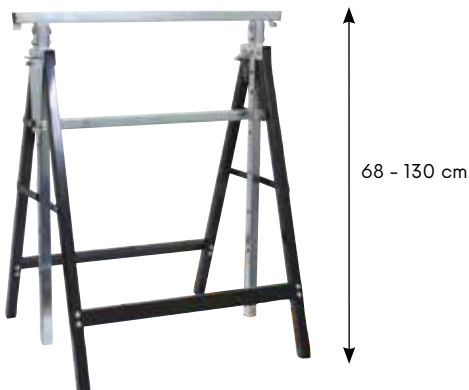

No.	specification	
36300	68 - 130 cm, max. 150 kg	1

ADJUSTABLE SAW HORSE



No.	specification	
37545	140 cm, height 98 - 165 cm	1
37546	120 cm, height 98 - 165 cm	1



PROFESSIONAL TILE CUTTING MACHINES

- tile cutting machines for the most demanding usage
- the travel has 9 sleeved skf ball bearings
- 4 of them are adjustable and define the limits of the travel
- spring-loaded tables
- possible to assemble for working with left hand
- all spare parts and repair services are guaranteed
- the cutting wheel from chrome-wolfram steel



TILE CUTTING MACHINE SUPER PRO "EVO"

NEW

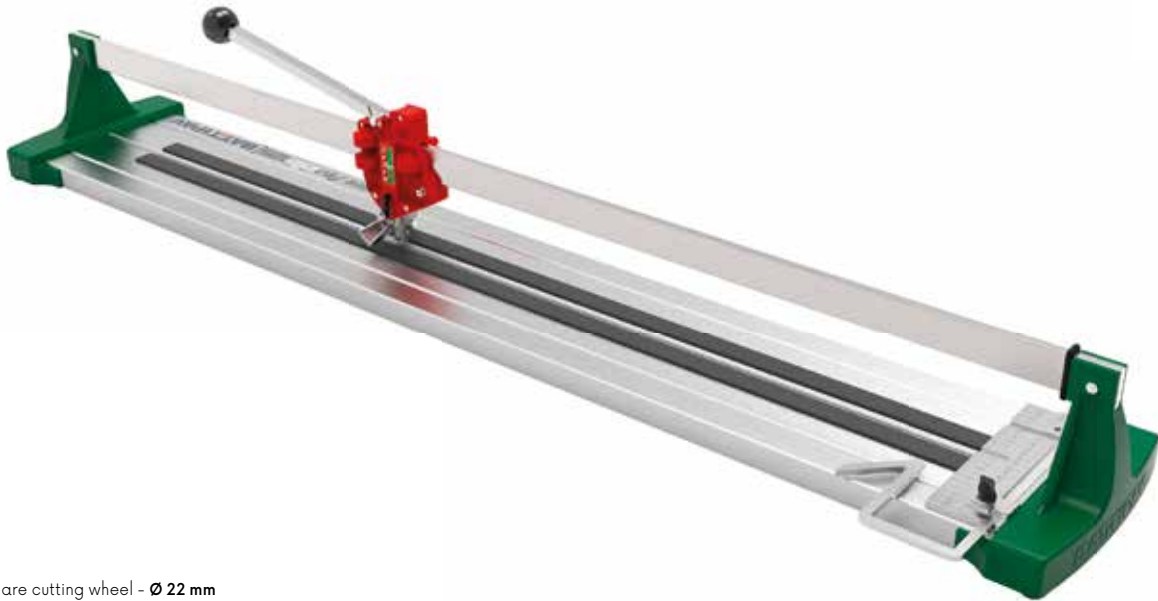

SUPER PRO



- 36195 spare cutting wheel - Ø 22 mm

No.	specification
36191	1250 mm



TILE CUTTING MACHINE



- 36195 spare cutting wheel - Ø 22 mm

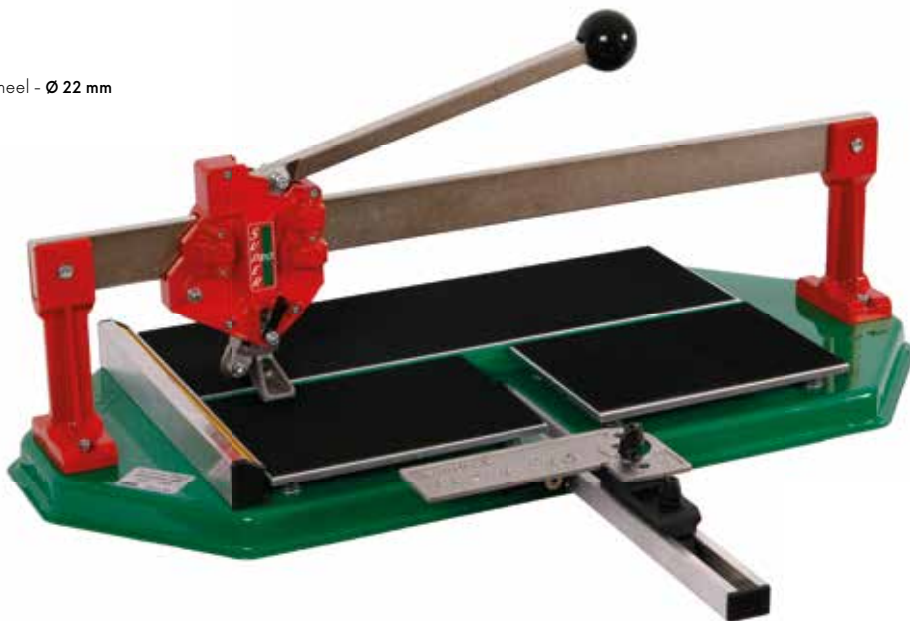

SUPER PRO



No.	specification
36145	SUPER PRO 450 mm
36160	SUPER PRO 600 mm
36175	SUPER PRO 750 mm
36190	SUPER PRO 900 mm



TILE CUTTING MACHINE + CASE



SUPER PRO STAND



· illustrative photo

· 36261 spare cutting wheel - Ø 15 mm

No.	specification	
36240	400 mm	1

No.	specification	
36200	sales stand	1
36199	sales stand fitted 36160, 36175, 36190	1

TILE CUTTING MACHINE „X“



· 36138 spare cutting wheel - Ø 22 mm

No.	specification	
36085	600 mm	1
36087	900 mm	1
36086	1300 mm	1



TILE CUTTING MACHINE



· 36195 spare cutting wheel - Ø 22 mm

No.	specification	
36080	600 mm	1
36081	750 mm	1
36082	900 mm	1

No.	specification	
36076	750 mm assembled	1
36077	900 mm assembled	1



TILE CUTTING MACHINE

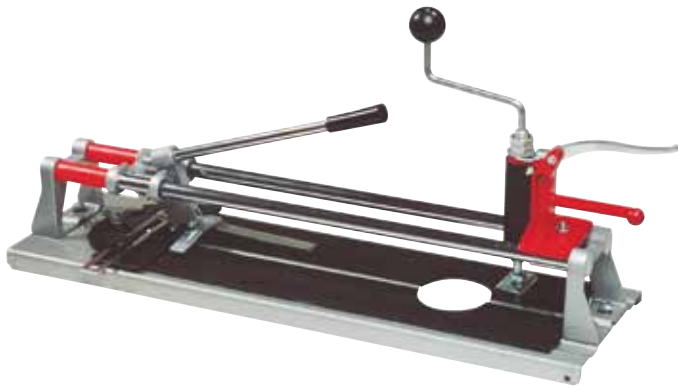

· 36128 spare cutting wheel - Ø 16 mm

No.	specification
36014	480 mm



4

TILE CUTTING MACHINE



· 36126 spare cutting wheel - Ø 15 mm

No.	specification	
36024	300 mm	10
36034	400 mm	10
36035	600 mm	4



TILE CUTTING MACHINE



· 36136 spare cutting wheel - Ø 22 mm

No.	specification
36036	480 mm



1

HAND TILE CUTTER



· 36136 spare cutting wheel - Ø 22,2 mm

No.	specification	
36046	22 mm	1



SPARE CUTTING WHEEL FOR TILE CUTTING MACHINE

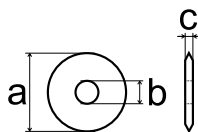

No.	specification	
36126	a= Ø 15 mm, b= Ø 6 mm, c= 1,5 mm	1
36128	a= Ø 16 mm, b= Ø 6 mm, c= 3 mm	1
36130	a= Ø 20 mm, b= Ø 6 mm, c= 5 mm	1
36136	a= Ø 22 mm, b= Ø 6 mm, c= 2 mm	1



JIG SAW BLADE FOR TILE CUTTING



No.	specification	
24055	Karbid - BOSCH, MAKITA	1



TILE PLIER

FESTA

NEW



6

No.	specification
36057	200 mm

TILE CUTTING PLIERS



10

No.	specification
36056	

TILE PLIER



1

No.	specification
36059	

TILE PLIER



6

No.	specification
36058	200 mm

SPONGE 160 X 110 X 60 MM



37028



37029

No.	specification	
37028	hydro sponge	1
37029	sponge cube	1

SPONGE 200 X 100 X 100 MM



37025



37026

No.	specification	
37025	soft molitan cube	1
37026	sponge cube	1

WASH BUCKET



1

No.	specification
37117	set
90070	tub 25 l

WASH BUCKET - ACCESSORIES



No.	specification
90072	grid
90071	metal rolls



1

TIPPED CLEANER



No.	specification
37012	



TIPPED CARBIDE CLEANER



No.	specification	
37006	30 mm	20
37007	50 mm	20
37008	spare blade 30 mm	50
37009	spare blade 50 mm	50



SET FOR APPLICATION AND REMOVING SILICONE

3x



No.	specification
16042	



DENTED SPREADER

4x



No.	specification
37053	



SQUEEGEE



No.	specification
16056	145 mm



SILICON SCRAPER



No.	specification
37054	



SILICON SCRAPER



• for joining of windows

No.	specification
37055	for joining of windows



SQUEEGEE

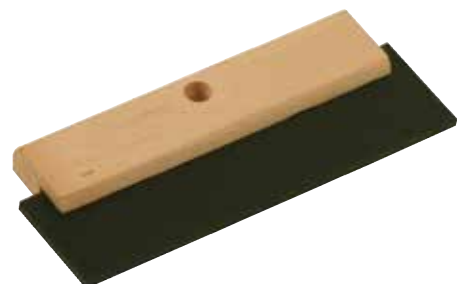

No.	specification
37011	180 mm
37021	280 mm



MAGNETS FOR TILES



4x

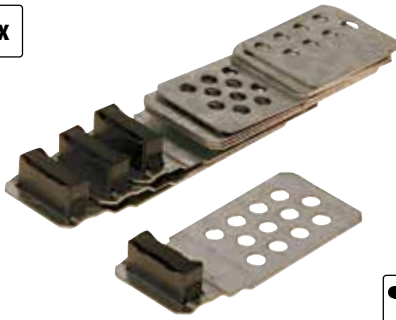

No.	specification
38920	

1

ADJUSTABLE MAGNETS TILES



4x



No.	specification
38923	

24

BUILDING CORNERS SET

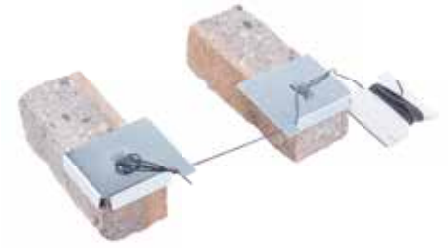

No.	specification
38919	



50

FLOATING FLOOR INSTALLATION KIT

24x



No.	specification
52130	

1

WEDGES

50x



No.	specification	pcs	
37210	95 x 45 x 15 - 0 mm	50	1
37211	70 x 30 x 8 - 0 mm	50	1



1

PUMP WEDGE



- dimension 15x17 cm
- height max. 5 cm

No.	specification
37220	



1

LEVELLING PADS

30x

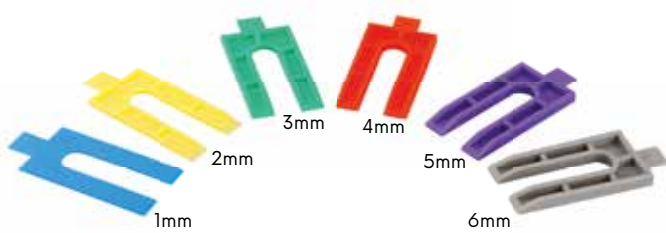

No.	specification
37212	1 - 6 mm, 5 pcs per size

1

WEDGES

FESTA



No.	specification	pcs
37204	55 x 20 x 0 - 6 mm	20
37203	65 x 18 x 0 - 12 mm	20
37202	80 x 25 x 3 - 10 mm	20
37201	100 x 25 x 1 - 16 mm	14
37200	150 x 25 x 1 - 25 mm	8
37205	55 x 8 x 0 - 10 mm	250

CAULKING GUN



No.	specification
38026	5x tip



1

POINTING BAG

MADE IN EU



No.	specification
38042	3x tip



1

PLASTIC CROSSES

100x



· reusable

No.	specification	pcs	
37195	1,0 mm	100	12
37196	1,5 mm	100	12
37197	2 mm	100	12
37198	3 mm	100	12

PLASTIC CROSSES



No.	specification	pcs		No.	specification	pcs	
37148	1,0 mm	200	100	37152	3 mm	150	100
37149	1,5 mm	200	100	37153	4 mm	100	100
37150	2 mm	200	100	37154	5 mm	75	100
37151	2,5 mm	200	100	37158	10 mm	30	100

PLASTIC WEDGES



No.	specification	pcs	
37155	0 - 8 mm	30	100
37156	0 - 4 mm	100	100
37157	2,5 - 8 mm	30	100

WEDGES



250x



No.	specification	pcs	
37205	55 x 8 x 0 - 10 mm	250	1

LEVELING CLIP WITH THREAD

50x



No.	specification	
37131	1 mm	40
37132	2 mm	40

LEVELING CAP WITH THREAD

50x



· reusable

No.	specification	
37130		15



SPACERS

50x





leveling wedges 37115, 37176

No.	specification	pcs	
37170	1 mm	50	60
37171	2 mm	50	60
37172	3 mm	50	60

SPACERS

100x



No.	specification	pcs		No.	specification	pcs	
37185	1 mm	100	1	37187	3 mm	100	1
37190	1,5 mm	100	1	37188	4 mm	100	1
37186	2 mm	100	1	37189	5 mm	100	1

SPACERS

600x



No.	specification	pcs	box	
37125	1 mm	600	38 x 28 x 19 cm	1
37126	1,5 mm	600	38 x 28 x 19 cm	1
37127	2 mm	600	38 x 28 x 19 cm	1

LEVELING SET

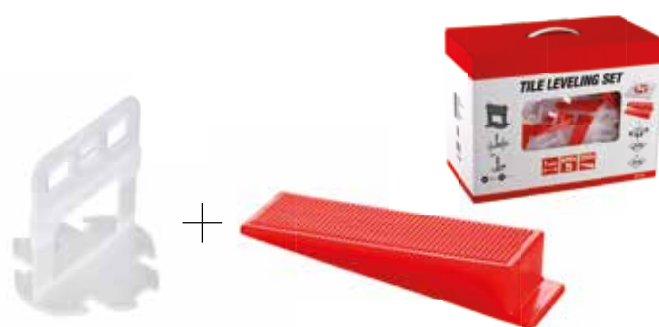

No.	specification	
37173	clips 1 mm, 400 pcs + wedges 200 pcs	1
37174	clips 1,5 mm, 400 pcs + wedges 200 pcs	1

LEVELING WEDGES



No.	specification	pcs	
37175		50	40
37176		400	3

LEVELING GUNS



No.	specification	
37177		1

LEVELING GUNS



No.	specification	
37178		1

POWDER 180 G



No.	specification	
● 37096	blue	10
● 37094	light blue	10
● 37097	red	10
● 37095	light red	10
● 37098	black	10



CHALK LINER 30 M + POWDER 150 G



- 3x quicker winding mechanism
- plummet line function



No.	specification	
37070		6

CHALK LINER 30 M + POWDER 150 G



- 5x quicker winding mechanism



No.	specification	
37065		6

CHALK LINER ABS 30 M + POWDER 180 G



No.	specification	
37069		10

CHALK LINER ABS 30 M



No.	specification	
37067		25

CHALK LINER PLASTIC 30 M



No.	specification	
37066		25

CHALK LINER 30 M

ALU



No.	specification	
37068		25

STRING RED

FESTA

STRING YELLOW

FESTA



No. specification

38895	50 m
38896	100 m

24
24

No. specification

38899	50 m
38900	100 m

24
24

STRING POLYETHYLENE 50 M

FESTA

STRING POLYETHYLENE 50 M

FESTA



No. specification

38907	red 1,0 mm
38908	red 1,7 mm
38909	red 2,0 mm

100
100
100

No. specification

38904	yellow 1,0 mm
38905	yellow 1,7 mm
38906	yellow 2,0 mm

100
100
100

STRING POLYETHYLENE 50 M

FESTA

STRING POLYETHYLENE 50 M

FESTA



No. specification

38910	orange 1,0 mm
38911	orange 1,7 mm
38912	orange 2,0 mm

100
100
100

No. specification

38901	white 1,0 mm
38902	white 1,7 mm
38903	white 2,0 mm

100
100
100

WAXED TWINE



PLUMB LINE WITH STRING 15 M

FESTA

PLUMB LINE

FESTA

No. length \varnothing

50920	50 m	1 mm
-------	------	------

80

No. specification

38916	150 g
38917	300 g
38918	500 g

10
10
10

No. specification

38913	150 g
38914	300 g
38915	500 g

5
5
5

POLYSTYRENE CUTTER

FESTA®



- voltage | frequency:
- power consumption:
- length of cut
- height of cut
- protection
- angle of cut

230 V / 50 Hz
160 W
137 cm
30 cm
IP44
0° - 90°

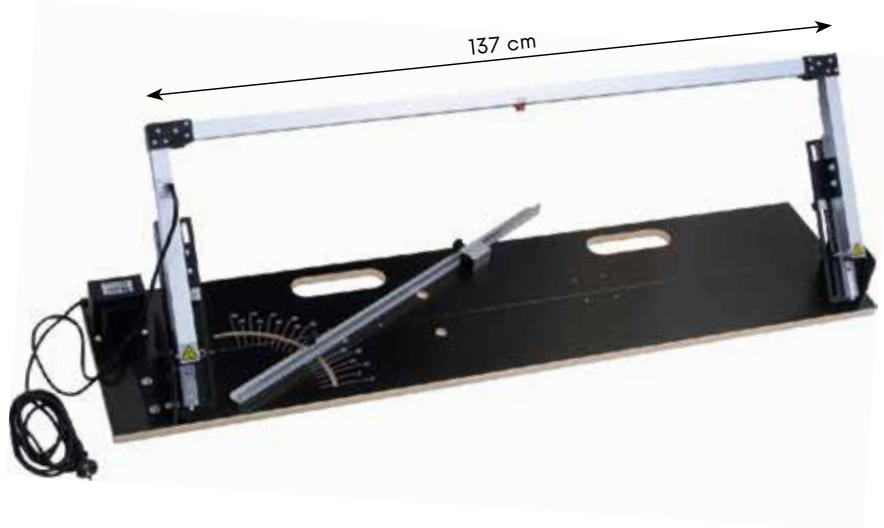
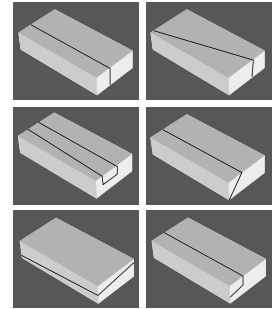

- equipment: Ni-Cr cutting wire, cleaning brass brush, inbus



No.	specification	
35345	Polystyrene cutter 1500 x 450 mm	1
35346	Spare heating string Ni-Cr	1
35347	Spare power supply	1

POLYSTYRENE CUTTER

FESTA®



- voltage | frequency:
- power consumption:
- length of cut
- height of cut
- protection
- angle of cut

230 V / 50 Hz
160 W
120 cm
30 cm
IP44
0° - 90°

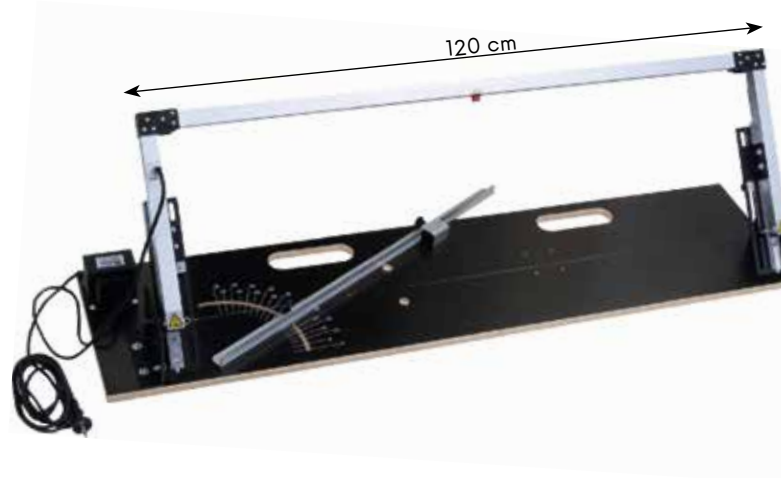
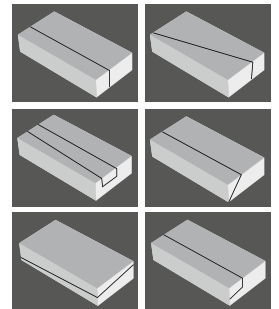

- equipment: Ni-Cr cutting wire, cleaning brass brush, inbus



No.	specification	
35330	Polystyrene cutter 1350 x 450 mm	1
35331	Spare heating string Ni-Cr	1
35347	Spare power supply	1

CORDLESS POLYSTYRENE CUTTER



- battery
- power
- temperature
- length of knife

36 V, 1,5 Ah Li-ion
180 W
max 350 C°
20 cm



FESTA®

Li-ion
technology



- equipment: 2 pcs battery, charger, blade, cleaning brass brush, inbus

No. specification

35323



1

ELECTRIC POLYSTYRENE CUTTER



- voltage / frequency
- power consumption
- temperature
- length of knife
- length of supply cable

230 V / 50 Hz
250 W
50-600 C°
25 cm
3 m



- equipment: cleaning brass brush, inbus, blades 25 cm, case

No. specification

35326	electric polystyrene cutter	1
35328	Spare knife for polystyrene cutter 14 cm	1
35329	Spare knife for polystyrene cutter 25 cm	1



1

FESTA®

GUIDE BAR FOR POLYSTYRENE CUTTER



- for 35323, 35326



No. specification

35327	Guide bar	1
35335	Spare knife - 30 cm	1



1

POLYSTYRENE ELECTRIC CUTTER



- temperature regulation

No. specification

35325 220 W



1

INSULATION WASHER



MOQ

No.	specification	
39206	Ø 40 mm	200
39207	Ø 60 mm	100

WASHER RABICO



1000x



No.	specification	
42420	Ø 30 mm	1

FASTENER

100x



No.	specification		No.	specification	
39210	Ø 10 x 100 mm	1	39218	Ø 10 x 180 mm	1
39212	Ø 10 x 120 mm	1	39217	Ø 10 x 200 mm	1
39214	Ø 10 x 140 mm	1	39219	Ø 10 x 220 mm	1
39216	Ø 10 x 160 mm	1			

MILLING MACHINE FOR POLYSTYRENE



No.	specification	
24727	Ø 65 mm	1
24729	Ø 68 mm	1
24728	Ø 70 mm	1

PLASTIC CORNER



No.	specification	
39234	2 m	25
39236	2,5 m	25
39238	3 m	25

ALU CORNER

ALU

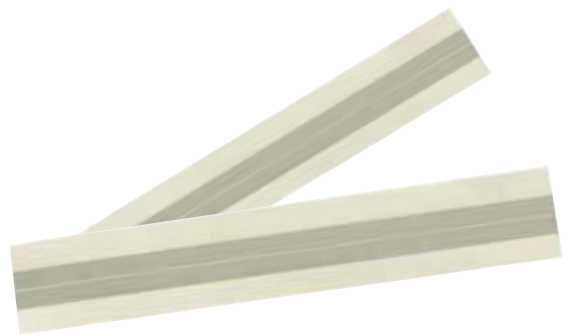

No.	specification	
39245	AL 30 m x 5 cm	1

WALL MESH

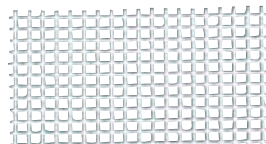

No.	specification	
42110	145 g/m ² 4 x 5 mm 1 m x 50 m	1
42112	145 g/m ² 4 x 5 mm 1 m x 10 m	1
42113	145 g/m ² 4 x 5 mm 1 m x 20 m	1

FENCING RABIC



Zn



No.	specification	
42312	1 m 50 bm 16 x 16 mm	1

LEVELING ROLL



No.	diameter	výška hrotů	length	
38950	Ø 69 mm	12 mm	25 cm	10
38951	Ø 69 mm	12 mm	40 cm	8
38952	Ø 122 mm	34 mm	25 mm	10
38953	Ø 122 mm	34 mm	40 cm	8
38954	Ø 122 mm	34 mm	60 mm	4

OUTSOLE WITH SPIKES PAIR



No.	specification	
38970	spikes 25 mm	1
38971	spikes 30 mm	1

DRYWALL PANEL LIFTER

- lift 153 - 344 cm
- max. load 54 kg



DRYWALL SET



No.	specification	
34300	set 9 pcs	10
34303	cup	60

No.	specification	
26775		1

HOLDER OF BOARDS



2x



No.	specification	
36312		12

HOLDER OF BOARDS



No.	specification	
36308	36 x 16,5 x 7,5 cm	10

PLASTERING SPLASH MACHINE

Zn



No.
37114

1

PLASTERING SPLASH MACHINE

Zn



No. specification
37115

1

WIRE SHEET

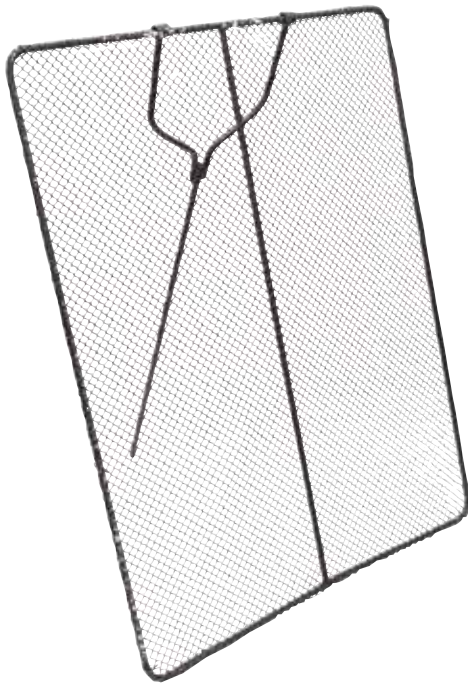

No.	width	high	eye mesh	
37236	0,8 m	1 m	10 mm	1
37237	0,8 m	1 m	12 mm	1
37238	0,8 m	1 m	16 mm	1
37239	0,8 m	1 m	20 mm	1

SIEVE FOR STUCCO



No.	width	high	eye mesh	
37216	50 mm	50 mm	2 mm	1
37217	50 mm	50 mm	3 mm	1
37218	50 mm	50 mm	4 mm	1

WOODEN PLASTER



No.	length	thickness	width
37120	200 mm	1,7 mm	20 mm
37119	250 mm	1,7 mm	20 mm

MOQ
10

10
10

PE. SCAFFOLDING NET GREEN



No.	specification			
42120	2,5 x 20 m, 80 g/ m ²	green		5

REVISION DOOR FOR DRYWALL AND MASONRY



FIBER REINFORCING FOR CONCRETE



- +/- 150 g/ 50 kg cement
- 600 - 900 g/m² concrete or mortar

No.	weight		
42115	0,9 kg		9

No.	specification		
82101	35 x 35 cm SDK		1
82104	63 x 63 cm SDK		1
82105	25 x 25 cm zdivo		1
82109	63 x 63 cm zdivo		1

DROP FORGED HOOK

Zn



No.	specification	
37229	14,5 cm	10

DROP HOOK ZINC COATED

Zn



No.	specification	
37231	14 cm single	10

DROP FORGED HOOK



No.	specification	
37232	14,5 cm	5

HOOK SET

6x



No.	specification	
37230	16 cm	6

CRAMP ZINC COATED

Zn



No.	specification	
37233	320 x 10 mm	100
37234	320 x 12 mm	100

CRAMP



No.	specification	
37235	250 x 12 mm	1



HEATING TORCHES

HEATING TORCH - SET



· Ø 17, 22, 40 mm

No. specification
69918 2 kW, 1,5 m hose



10

HEATING TORCH - SET



· Ø 25, 35, 50 mm

No. specification
69919 19,5 kW, 1,5 m hose



10

HEATING TORCH - SET



· Ø 55 mm

No. specification
69904 60 kW, 850 mm, 5 m hose, piezo



8

HEATING TORCH 3KW

FESTA

TÜVRheinland
AK 601423580004

No.	specification
69914	300 mm + 2 m hose

5

HEATING TORCH

FESTA

TÜVRheinland
AK 601423580004

No.	specification
69900	Ø 35 mm, 300 mm, without hose
69901	Ø 35 mm, 300 mm + 3 m hose

10

5

HEATING TORCH

FESTA

TÜVRheinland
AK 601423580004

No.	specification
69902	Ø 55 mm, 550 mm, without hose

10

HEATING TORCH

FESTA

TÜVRheinland
AK 601423580004

No.	specification
69903	Ø 55 mm, 550 mm + 3 m hose

10

10

HEATING TORCH

FESTA

TÜVRheinland
AK 601423580004

No.	specification
69905	Ø 55 mm, 850 mm, without hose

10

HEATING TORCH

FESTA

TÜVRheinland
AK 601423580004

No.	specification
69906	Ø 55 mm, 850 mm + 3 m hose

10

5

HEATING TORCH - SET WITH REDUCTION VALVE

FESTA



· reduction valve for connection 10 and 33 kg

No.	specification
69917	Ø 55 mm, 850 mm + 3 m hose



1

HOSE FOR HEATING TORCH

FESTA



No.	specification
69910	3 m with ending
69911	5 m with ending
69912	10 m with ending



20

12

8

THREADED CARTRIDGE HEATING TORCH

FESTA



· max. temp. 1200 °C
 · power 1,7 kW
 · burner diam. Ø 20 mm



20

No.	specification
69930	piezo

PIERCEABLE CARTRIDGE HEATING TORCH

FESTA



· max. temp. 1200 °C
 · power 1,7 kW
 · burner diam. Ø 20 mm



12

No.	specification
69931	piezo

PROPANE BUTANE REDUCTION VALVE



No. specification
69923 W 21,8; G 3/8; 4 bar

1

PROPANE BUTANE REDUCTION VALVE



outlet pressure	4,0 bar
nominal flow rate	16 kg h
inlet connection	W 21,8 x 1 14" LH
outlet connection	G3 8" LH

No. specification
69920

25

PRESSURE REGULATOR PROPAN - BUTAN



inlet pressure	25 bar
outlet pressure	0,5 - 4,0 bar
nominal flow rate	16 kg h
inlet connection	W 21,8 x 1 14" LH
outlet connection	G3 8" LH

No. specification
69907

1



ONE WAY PRESSURE VALVE



out G 3/8L, for 2 kg PB bottle

No. specification
69928

1

PRESSURE REGULATOR



No. specification
69908 30 mBar, prickle
69909 30 mBar, thread G 1/4L

1

1

PLASTER BOWL



No.	specification	
37121	conic	1

PLASTER BOWL



No.	specification	
37122	low	1

PLASTER BOWL



No.	specification	
33275	low, rubber	20



BUCKET ZN COATED

Zn



No.	specification	
39000	5 l	40
39001	10 l	30
39002	12 l	20
39003	15 l	20

BUCKET



No.	specification	
39005	5 l	1
39010	10 l	1
39012	12 l	1
39014	15 l with funnel	1
39020	20 l	1
39021	20 l with funnel	1

BUCKET



No.	specification	
39192	30 l	20
39193	45 l	20



ROUND TUB



No.	specification	
39045	45 l Ø 54 x 27 cm	1
39065	60 l Ø 60 x 35 cm	1
39090	90 l Ø 66 x 35 cm	1



RECTANGULAR TUB



No.	specification	
39145	45 l 71 x 40 x 21 cm	1
39165	65 l 71 x 40 x 30 cm	1
39190	85 l 77 x 48 x 30 cm	1



MASONRY PULLEY

No.	specification	
26780	0,5 t A with hook	1
26781	0,5 t B with eye	1
26782	0,5 t C with hook, with cover	1
26783	0,5 t D with eye, with cover	1



PACKAGING FOIL



No.	width	length	thickness	
38095	500 mm	600 m	8 µm transparent	1
38097	100 mm	150 m	20 µm transparent	1
38096	500 mm	200 m	23 µm black	1



PE BAG BUILDING WASTE
TRANSPARENT

No.	width	length	thickness	volume	pcs	
39194	500 mm	1100 mm	0,16 mm	100	1	10
39196	600 mm	1200 mm	0,16 mm	110	1	10
39198	700 mm	1100 mm	0,16 mm	120	1	10
39200	500 mm	1100 mm	0,20 mm	100	1	10
39202	600 mm	1200 mm	0,20 mm	110	1	10
39204	700 mm	1100 mm	0,20 mm	120	1	10

PE BAG BUILDING WASTE
BLACK

No.	width	length	thickness	volume	pcs	
39195	500 mm	1100 mm	0,16 mm	100	1	10
39197	600 mm	1200 mm	0,16 mm	110	1	10
39199	700 mm	1100 mm	0,16 mm	120	1	10
39201	500 mm	1100 mm	0,20 mm	100	1	10
39203	600 mm	1200 mm	0,20 mm	110	1	10
39205	700 mm	1100 mm	0,20 mm	120	1	10



WASTE BAG



No.	width	length	thickness	pcs	
38060	700 mm	1100 mm	0,08 mm	10	1
38063	700 mm	1100 mm	0,10 mm	3	1
38065	700 mm	1100 mm	0,20 mm	3	1



WASTE BAG



No.	width	length	thickness	pcs	
38050	500 mm	600 mm	0,04 mm	25	1
38052	600 mm	800 mm	0,04 mm	25	1
38054	700 mm	1100 mm	0,04 mm	25	1



PE BAG BUILDING WASTE



5x



FOIL HOSE



half hose



No.	width	length	thickness	
38055	1200 mm	1000 mm	0,08 mm	5

No.	width	thickness	specification	
38089	1,2 m	0,1mm	150 bm half hose	1

FIXING WIRE



1000x



No.	specification	
42365	1,25 100 mm	1
42366	1,25 125 mm	1
42367	1,25 140 mm	1
42368	1,25 160 mm	1

SPIRAL BINDER WIRE



50050

50052

No.	specification	
50052		12
50050		1

SPIRAL BINDER WIRE



No.	specification	
50051		2

EXCAVATION WARNING TAPE



No.	width	length	
38955	22 cm	20 m	1
38956	22 cm	50 m	1

EXCAVATION WARNING TAPE



No.	width	length	
38957	22 cm	20 m	1
38958	22 cm	50 m	1

EXCAVATION WARNING TAPE



No.	width	length	
38959	22 cm	20 m	1
38960	22 cm	50 m	1

WARNING TAPE



No.	specification	length	
38944	ZÁKAZ VSTUPU, SK	80 mm 250 m	8
38945	VSTUP ZAKÁZÁN, CZ	80 mm 250 m	8

WARNING TAPE



No.	length	
38948	80 mm 250 m	8

WARNING TAPE

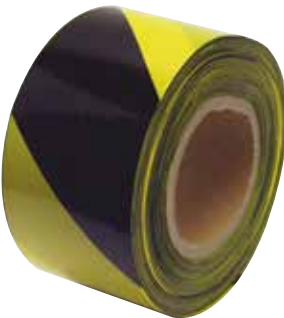

No.	length	
38946	80 mm 250 m	8

WARNING TAPE SELF - ADHESIVE



No.	length	specification	
38947	48 mm 33 m	right	48
38961	48 mm 33 m	left	48

MARKING TAPE



No.	width	length	thickness	
38949	50 mm	50 m	0,15 mm	36

SAFETY MESH FENCING

140 g/m²
UV STABLE

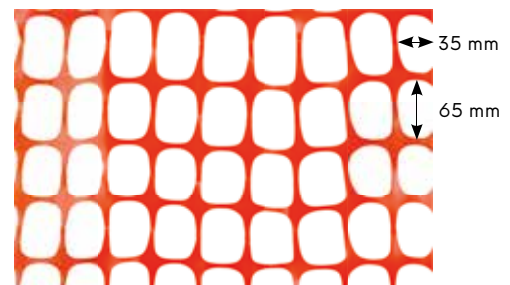

No.	specification	
42190	1,2 x 50 m HDPE 140g/m ²	1

PVC TAPES SET

5x



No.	width	length	thickness	
38931	19 mm	5 m	0,13 mm	100

PVC TAPE BLACK



No.	width	length	thickness	
38932	19 mm	10 m	0,13 mm	10

PVC TAPES SET



No.	width	length	thickness	
38925	19 mm	10 m	0,13 mm	10

PVC TAPE, BLACK



No.	width	length	thickness	
38968	19 mm	10 m	0,19 mm	10

TEXTILE TAPE - BLACK



No.	width	length	
38927	19 mm	10 m	10

TEXTILE TAPE, KARPET



No.	width	length	
38980	48 mm	10 m	24
38981	48 mm	20 m	24

BOTH SIDES ADHESIVE TAPE WITH REINFORCEMENT



No.	width	length	
38924	50 mm	10 m	1
38964	50 mm	25 m	1

BOTH SIDES ADHESIVE TAPE

PP
Polypropylen

No.	width	length	
38929	50 mm	10 m	1
38966	50 mm	25 m	1

BOTH SIDES ADHESIVE TAPE

MADE IN
EU

No.	width	length	
38990	19 mm	5 m	48
38991	25 mm	5 m	36

PROFESSIONAL REINFORCED WATERPROOF TAPE

FESTA



MADE IN EU



No.	width	length	
38995	48 mm	25 m	24

REINFORCED WATERPROOF TAPE



No.	width	length	
38965	30 mm	10 m	1
38928	50 mm	10 m	72
38934	50 mm	45 m	24

DUCT TAPE, WATERPROOF

MADE IN EU



No.	width	length	
37275	48 mm	50 m	24

MASKING TAPE

MADE IN EU



No.	width	length	
37271	38 mm	20 m	24
37270	48 mm	20 m	24
37272	48 mm	50 m	24

PE MASKING TAPE FOR WINDOWS



for 30 days

MADE IN EU



No.	width	length	
37273	48 mm	50 m	24

PAPER MASKING TAPE

MADE IN EU



No.	width	length	
37263	38 mm	50 m	24
37264	48 mm	50 m	24

PVC TAPE ADHESIVE

MADE IN EU



No.	width	length	
37266	30 mm	33 m	60
37267	38 mm	33 m	48
37268	50 mm	33 m	36

PAPER MASKING TAPE

MADE IN EU



No.	width	length	
37255	19 mm	50 m	12
37256	25 mm	50 m	12
37257	30 mm	50 m	7
37258	38 mm	50 m	6
37259	50 mm	50 m	6

PACKAGING PVC TAPE

MADE IN EU



No.	width	length	
38942	50 mm	50 m	72

PLATED TAPE

NEW

ALU

UV
STABLE

No.	width	length	
38972	50 mm	50 m	1
38973	50 mm	100 m	1

ALU SELF ADHESIVE TAPE

ALU



No.	width	length	
38963	48 mm	10 m	1
38943	48 mm	45 m	24

ANTI - SLIP TAPE



No.	width	length	thickness	
37280	25 mm	15 m	0,8 mm	72
37281	50 mm	15m	0,8 mm	36

SELF WELDING TAPE



No.	width	length	
38930	19 mm	5 m	100

FIBERGLASS TAPE SELF ADHESIVE

MADE IN
EU

No.	width	length	
38935	50 mm	20 m	60
38937	50 mm	45 m	36
38939	50 mm	90 m	24
38940	50 mm	153 m	24

FIBERGLASS FELT

MADE IN
EU

No.	width	length	
38941	50 mm	25 m	40

TEFLON TAPE

TEFLON



No.	width	length	thickness	
38969	19 mm	15 m	0,2 mm	10

TEFLON TAPE

TEFLON



No.	width	length	thickness	
38933	12 mm	10 m	0,075 mm	10

TEFLON TAP

TEFLON

· for water and gas installations



No.	width	length	
38926	2 mm	150 m	20

PACKING TAPE DISPENSER



No.	
38985	1

BINDING TAPE, VELCRO



No.	specification	
45471	12 mm x 5 m	1

VELCRO TAPE 3 PCS

3x

FESTA



No.	width	length	
37295	20 mm	150 mm	1
37296	20 mm	200 mm	1
37297	20 mm	250 mm	1

CAULKING GUN HEAVY DUTY



No.	specification	
38013		12

CAULKING GUN



No.	specification	
38001		24

CAULKING GUN



No.	specification	
38012		6

CAULKING GUN



NEW



No.	specification	
38024		1

CAULKING GUN WITH BACKSTEP



No.	specification	
38010	6 square	24

CAULKING GUN



No.	specification	
38025		24

CAULKING GUN FOR CHEMIC ANCHOR 380 ML



No.	specification	
38020		12

CAULKING GUN



No.	specification	
38006		12

CAULKING GUN

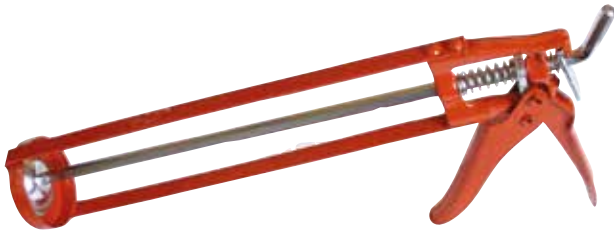

No.	specification	
38002	6 square	24 

CAULKING GUN - PLASTIC



No.	specification	
38003	6 square	24 

CAULKING GUN



No.	specification	
38007		24 

CAULKING GUN - SEMI CLOSED



No.	specification	
38008		24 

CAULKING GUN WITH TEETH



No.	specification	
38009		24 

CAULKING GUN



No.	specification	
38000		24 

CAULKING GUN

FESTA

No.	specification	
38005	310 ml	20 
38014	top 3 ks	100

CAULKING GUN

FESTA

No.	specification	
38004	600 ml	12 
38014	top 3 ks	100

FOAM GUN WITH TEFLON COATING



TEFLON



20

No. specification

38018

FOAM GUN WITH TEFLON COATING



TEFLON



20

No. specification

38017

FOAM GUN



TEFLON



20

No. specification

38016

FOAM GUN FOR FOAMS



TEFLON

TEFLON



20

No. specification

38015

FOAM GUN

NEW



20

No. specification

38031

FOAM GUN ABS



No. specification

38022 ABS

20

FOAM GUN



No. specification

38021

24



CAULKING GUN



· capacity 1,5 l

No.	specification
38026	5x tip



25

HEATING GUN



voltage	230V / 50Hz
power consumption	2000W
position of switch	0 - I (350°C) - II (600°C)
accessories	stainless extensions - 4 pcs

No.	specification
35320	2000 W



1

SPARE NOZZLE GUN TEFLON

TEFLON



· for PU guns 38015, 38016, 38017, 38018

No.	specification
38030	



5

POINTING BAG



No.	specification
38042	3x tip



6

HEATING GUN WITH REGULATION OF TEMPERATURE AND AIR FLOW



· digital display



voltage	230V / 50Hz
power consumption	2000W
position of switch	0 - I (50°C) - II (50 - 600°C)
air flow	250 - 500 l/min.
accessories	stainless extensions - 4 pcs

No.	specification
35322	2000 W



1



HOT MELT GLUE GUNS

HOT MELT GLUE GUN - WIRELESS



· Ø glue stick 11,2 mm



No.	specification
89975	80 W 230 V



HOT MELT GLUE GUN



· Ø glue stick 7,2 mm



No.	specification
89970	15 W 230 V



HOT MELT GLUE GUN



· Ø glue stick 11,2 mm



No.	specification
89973	60 W 230 V



HOT MELT GLUE STICK - TRANSPARENT

HOT MELT GLUE STICK - TRANSPARENT

HOT MELT GLUE STICK - MULTICOLOUR



No.	Ø tyčinky glue stick	length	počet ks v balení pcs	100
89980	7,2 mm	100 mm	12 pcs	100
89988	7,2 mm	100 mm	1 kg	25

No.	Ø tyčinky glue stick	length	počet ks v balení pcs	50
89985	11,2 mm	200 mm	10 pcs	50
89987	11,2 mm	200 mm	1 kg	25

No.	Ø tyčinky glue stick	length	počet ks v balení pcs	100
89989	7,2 mm	100 mm	12 pcs	100
89990	11,2 mm	200 mm	10 pcs	50



PAINT BRUSHES

PAINT BRUSH NATURAL



No.	wideness	thickness	length	
52212	20 mm	15 mm	40 mm	12
52213	30 mm	15 mm	45 mm	12
52214	40 mm	15 mm	45 mm	12
52215	50 mm	15 mm	50 mm	12
52216	60 mm	15 mm	60 mm	12
52217	70 mm	15 mm	65 mm	12
52218	80 mm	15 mm	65 mm	12
52220	100 mm	15 mm	70 mm	12

PAINT BRUSH



No.	wideness	thickness	length	
52202	20 mm	12,5 mm	38 mm	12
52203	30 mm	13 mm	38 mm	12
52204	40 mm	14 mm	44 mm	12
52205	50 mm	16 mm	44 mm	12
52206	60 mm	17 mm	52 mm	12
52208	80 mm	17 mm	52 mm	12
52207	100 mm	18 mm	52 mm	12

RADIATOR PAINT BRUSH



No.	wideness	thickness	length	
52283	25 mm	10 mm	44 mm	12
52284	38 mm	10 mm	44 mm	12
52285	50 mm	10 mm	44 mm	12
52286	62 mm	10 mm	50 mm	12
52288	76 mm	10 mm	50 mm	12

PAINT BRUSH SET - PLASTIC HANDLE

3x



No.	specification	
52070	20, 30, 50 mm	50

PAINT BRUSH SET - PLASTIC HANDLE

5x



No.	specification
52071	15 mm, 25 mm, 40 mm, 60 mm, 80 mm



50

SCRAPER FOR PAINT AND LACQUER



No.
37005



12

PAINT BRUSH PROFESSIONAL



No.	specification
52075	Ø 90 mm



10

PAINT BRUSH PROFESSIONAL



No.	widness	length
52076	170 mm	80 mm



10

PAINT BRUSH



No.	specification	length
52077	Ø 105 mm	70 mm



12

PAINT BRUSH



No.	widness	length
52078	170 mm	70 mm



12



APPLICATION OF THE ROLLERS		PAINTS OR VARNISHES (LACQUERS)												
MATERIAL	TICKNESS OF PILE mm	DISPERSION	ANTICORROSIVE	RESIN	OIL	WATER DIL.	POLYESTER	BINDER	GLAZING	LATEX	EPOXY	2-COMPONENT	THICK	ACRYLIC
PES	20	•						•		•			•	
PES	20	•	•			•		•		•				•
PAC	18	•						•		•				
PAC	12, 13	•								•				
PAD	18, 21	•								•				
PAD	13	•	•							•				
LAMBSKIN BERÁNEK	23	•								•				
NYLON	13		•	•	•	•	•			•	•	•		
VELOUR	4		•	•			•				•	•	•	
MICROFIBRE	10					•			•	•				
MOLITAN				•		•								•



PAINTING ROLLERS

PAINTING SET

MADE IN EU

PAC



No.	polster 4	180 mm	Ø 8 mm	Ø 53 mm	18 mm	1
52600						

PAINTING SET

MADE IN EU

PES



PAINTING SET

MADE IN EU

- 1x paintroller PAD 13mm/ 10 cm
- 1x paintroller PAC 12mm/ 10 cm
- 1x paintroller PES 11mm/ 10 cm
- handle
- bowl

No.	180 mm	Ø 6 mm	Ø 42 mm	20 mm	25
52610					
52605	250 mm	Ø 6 mm	Ø 42 mm	20 mm	20



No.	10
52602	

PAINTROLLER POLYACRYL



PAC



No.					
52331	100 mm	Ø 6 mm	Ø 17 mm	12 mm	50
52334	250 mm	Ø 8 mm	Ø 48 mm	12 mm	10

PAINTROLLER POLYACRYL



PAC



No.					
52391	polster 5 250 mm	Ø 8 mm	Ø 54 mm	18 mm	10

PAINTROLLER POLYACRYL



PAC



No.					
52328	polster 5 250 mm	Ø 8 mm	Ø 54 mm	18 mm	10
52456	polster 7 250 mm	Ø 8 mm	Ø 67 mm	18 mm	10

PAINTROLLER POLYAMIDE



PAD



No.					
52428	polster 7 250 mm	Ø 8 mm	Ø 67 mm	18 mm	10

PAINTROLLER POLYESTER



PES



No.					
52315	polster 5 180 mm	Ø 8 mm	Ø 54 mm	20 mm	10

ROLLER FOR GLAZING - NYLON



PAD



No.					
52421	100 mm	Ø 6 mm	Ø 17 mm	13 mm	50
52424	250 mm	Ø 8 mm	Ø 48 mm	13 mm	10

PAINTROLLER, POLYESTER



PES



No.					
52305	180 mm	Ø 6 mm	Ø 42 mm	20 mm	10
52306	250 mm	Ø 6 mm	Ø 42 mm	20 mm	10

VARNISHING ROLLER, FOAM



No.	specification	length	width	height	weight
52471	straight	100 mm	Ø 6 mm	Ø 35 mm	50

CORNER PAINTROLLER POLYACRYL



PAC



No.	specification	width	height	weight
52601	with handle	Ø 6 mm	18 mm	1

TELESCOPIC POLE

ALU



No.	length	material	weight
52010	120 cm	ALU	50
52012	240 cm	ALU	25



TELESCOPIC POLE



No.	length	material	weight
52020	300 cm	steel	10



TELESCOPIC POLE



No.	length	material	weight
52030	240 cm	fiberglass	6



PAINT TRAY



No.	specification	length	width	height	weight
52662	150 x 270 mm	100 mm			1
52666	260 x 290 mm	180 mm			1
52671	330 x 340 mm	250 mm			1

PAINT BUCKET



No.	volume	weight
52694	8 l	25
52695	12 l	20

WIPE GRID



No.	widness	hight	
52652	230 mm	250 mm	100
52656	270 mm	290 mm	100

HANDLE



No.	specification	
52640	5 cm Ø 6 mm	100
52645	8,5 cm Ø 6 mm x 27 mm	100

HANDLE



No.	specification	
52630	18 cm Ø 6 mm	100
52635	25 cm Ø 6 mm	100
52620	18 cm Ø 8 mm	50
52625	25 cm Ø 8 mm	50

COVER TAPE SELF ADHESIVE WITH COVER SHEET



No.	widness	length	
37243	55 cm	30 m	60
37244	110 cm	30 m	30
37245	140 cm	30 m	30
37246	180 cm	15 m	30
37290	210 cm	20 m	30
37247	240 cm	15 m	30
37291	270 cm	16 m	30

SAFETY OVERALL WITH HOOD



No.	specification	
50585	size M	1
50586	size L	1
50587	size XL	1
50588	size XXL	1

COVER SHEET FOR DOOR WITH ZIPPER



No.	specification	
37248	1,2 x 2,2 m 100 µm tape 45 mm x 25 m	25

COVER SHEET



No.	volume	material thickness	
37250	4 x 5 m	0,007 mm	100
37251	4 x 12,5 m	0,007 mm	50
37252	2 x 50 m	0,007 roll	20

COVER SHEET



No.	specification	material thickness	
37253	4 x 5 m	0,03 mm	100

CORRUGATED CARDBOARD



No.	widness	length	
54008	1 m	10 m	1

EKONOMIK ** STANDARD *** PROFI ****



- Double welded hems with polypropylen cord
- Silver layer for increased reflection of sunshine
- Sluminium eylets in the distance of 1 m

TARPAULIN EKONOMIK

· blue



No.	specification		No.	specification	
25369	2 x 2 m	50	25374	4 x 6 m	5
25370	2 x 3 m	20	25376	5 x 8 m	5
25371	3 x 4 m	10	25378	6 x 10 m	2
25372	3 x 5 m	10	25379	8 x 12 m	2
25373	4 x 5 m	10	25380	10 x 15 m	2

TARPAULIN STANDARD

· blue-silver



70 g/m²



No.	specification		No.	specification	
25155	2 x 2 m	50	25025	5 x 5 m	10
25006	2 x 3 m	50	25030	5 x 6 m	10
25009	3 x 3 m	35	25040	5 x 8 m	5
25012	3 x 4 m	20	25048	6 x 8 m	5
25015	3 x 5 m	10	25060	6 x 10 m	5
25016	4 x 4 m	10	25096	8 x 12 m	2
25020	4 x 5 m	10	25150	10 x 15 m	2
25024	4 x 6 m	10	25153	15 x 20 m	1

TARPAULIN STANDARD

· green



70 g/m²



No.	specification		No.	specification	
25179	2 x 2 m	50	25184	4 x 6 m	10
25180	2 x 3 m	50	25186	5 x 8 m	5
25195	2 x 8 m	20	25188	6 x 10 m	5
25181	3 x 4 m	20	25189	8 x 12 m	2
25182	3 x 5 m	10	25190	10 x 15 m	2
25183	4 x 5 m	10			

TARPAULIN PROFESSIONAL

· blue-silver



140 g/m²



No.	specification		No.	specification	
25206	2 x 3 m	25	25240	5 x 8 m	4
25212	3 x 4 m	10	25248	6 x 8 m	3
25215	3 x 5 m	8	25260	6 x 10 m	3
25220	4 x 5 m	8	25296	8 x 12 m	2
25224	4 x 6 m	8	25350	10 x 15 m	1
25230	5 x 6 m	8			

TARPAULIN PROFESSIONAL

· green-green



200 g/m²



No.	specification		No.	specification	
25160	2 x 3 m	15	25164	4 x 6 m	3
25171 NEW	2 x 8 m	1	25167	6 x 8 m	2
25162	3 x 5 m	5	25169	8 x 12 m	1
25163	4 x 5 m	4	25170	10 x 15 m	1

TARPAULIN ROUND

· blue-silver



120 g/m²



No.	specification	
25003	Ø 3,6 m	15
25004	Ø 4,5 m	5
25005	Ø 5,5 m	4
25002	Ø 6,5 m	3

TARPAULIN CAMOUFLAGE

· camouflage



80 g/m²



No.	specification	
25365	5 x 8 m	5
25366	6 x 10 m	2
25367	8 x 12 m	2
25368	10 x 15 m	2



TENSIONER FOR TARPAULINS

4x



No.	specification	
25400	20 cm	1

APPLICATOR OF EYELETS FOR PE TARPAULINS



No.	specification	
25410	applicator of eyelet + 25 ok eyelets	1

EYELETS FOR PE TARPAULINS

10x



No.	specification	
25001		1





SNAP HOOKS CHAINS AND WIRE ROPES

TURN BUCKLE

DIN 1480

Zn





No.	specification		No.	specification	
50100	5 x 70 mm	10	50104	12 x 200 mm	10
50101	6 x 90 mm	10	50106	16 x 230 mm	10
50102	8 x 125 mm	10	50108	20 x 220 mm	10
50103	10 x 150 mm	10			

SNAP HOOK

DIN 5299 C

Zn





No.	specification		No.	specification	
51204	4 mm	10	51209	9 mm	10
51205	5 mm	10	51210	10 mm	10
51206	6 mm	10	51211	11 mm	10
51207	7 mm	10	51212	12 mm	10
51208	8 mm	10			

RAPID QUICK LINK

Zn





No.	specification		No.	specification	
51241	4 mm	10	51245	8 mm	10
51242	5 mm	10	51246	10 mm	10
51243	6 mm	10	51247	12 mm	10
51244	7 mm	10			

S HOOK

Zn





No.	specification		No.	specification	
51271	3 mm	10	51275	7 mm	10
51272	4 mm	10	51276	8 mm	10
51273	5 mm	10	51278	10 mm	10
51274	6 mm	10			

EYE NUT

DIN 5820

Zn





No.	specification		No.	specification	
51320	6 mm	10	51324	14 mm	10
51321	8 mm	10	51325	16 mm	10
51322	10 mm	10	51327	20 mm	10
51323	12 mm	10			

EYE BOLT

DIN 5820

Zn



No.	specification		No.	specification	
51300	6 mm	10	51305	16 mm	10
51301	8 mm	10	51306	18 mm	10
51302	10 mm	10	51307	20 mm	10
51303	12 mm	10	51308	22 mm	10
51304	14 mm	10			

WIRE ROPE CLIP

Zn



No.	specification	
51280	3 mm	10
51281	5 mm	10
51282	6 mm	10
51283	8 mm	10

No.	specification	
51284	10 mm	10
51286	12 mm	10
51287	14 mm	10
51288	16 mm	10

SWIVEL SNAP HOOK

Zn



No.	specification	
51220	53 mm	10
51221	67 mm	10
51222	76 mm	10

WIRE ROPE CLIP

Zn



No.	specification	
51225	3,8 mm	10
51226	4,5 mm	10
51227	6,0 mm	10

SHORT LINK CHAIN

DIN 5685 A

Zn



No.	size of eye	length	
51402	2 x 10 mm	110 m	1
51403	3 x 16 mm	60 m	1
51404	4 x 21 mm	40 m	1
51405	5 x 23 mm	30 m	1

No.	size of eye	length	
51406	6 x 24 mm	18 m	1
51407	7 x 50 mm	16 m	1
51408	8 x 32 mm	10 m	1
51410	10 x 39 mm	10 m	1

SHORT LINK CHAIN

DIN 5686

Zn



No.	Ø of material	length	
51430	1,4 mm	150 m	1
51431	1,6 mm	150 m	1
51432	1,8 mm	150 m	1

No.	Ø of material	length	
51433	2,0 mm	118 m	1
51435	2,5 mm	70 m	1
51436	2,8 mm	50 m	1

LONG LINK CHAIN

DIN 5685 C

Zn



No.	size of eye	length	
51412	2 x 12 mm	80 m	1
51413	3 x 26 mm	60 m	1
51414	4 x 32 mm	38 m	1
51415	5 x 35 mm	32 m	1

No.	size of eye	length	
51416	6 x 43 mm	18 m	1
51417	7 x 50 mm	16 m	1
51418	8 x 54 mm	10 m	1
51420	10 x 65 mm	10 m	1

LINK CHAIN



No.	specification	
51450	6 mm 25 m red-white	1

ROPE AND WIRE CONNECTOR - DOUBLE

DIN 5685 C

Zn





No.	specification	
51348	Ø 10 mm	10

ROPE AND WIRE CONNECTOR

DIN 5685 C

Zn



No.	specification		No.	specification	
51338	Ø 5 mm	10	51341	Ø 10 mm	10
51340	Ø 8 mm	10			

WIRE ROPE THIMBLE

Zn



No.	specification	
51257	Ø 14 mm	10
51258	Ø 16 mm	10
51259	Ø 18 mm	10
51260	Ø 20 mm	10
51261	Ø 22 mm	10
51262	Ø 24 mm	10
51263	Ø 26 mm	10
51264	Ø 28 mm	10
51265	Ø 30 mm	10

WIRE ROPE ZN COATED

Zn



No.	rope diameter	length	
51100	Ø 1 mm	500 m	1
51101	Ø 1,2 mm	500 m	1
51102	Ø 1,5 mm	500 m	1
51103	Ø 2 mm	200 m	1
51104	Ø 3 mm	200 m	1
51105	Ø 4 mm	100 m	1
51106	Ø 5 mm	75 m	1
51107	Ø 6 mm	75 m	1
51130	Ø 8 mm	75 m	1
51131	Ø 10 mm	50 m	1
51132	Ø 12 mm	50 m	1

WIRE ROPE ZN COATED IN PVC COVER

Zn



No.	rope diameter	length	
51108	Ø 2/3 mm	200 m	1
51109	Ø 3/4 mm	100 m	1
51110	Ø 4/5 mm	75 m	1
51111	Ø 5/6 mm	50 m	1

STAINLESS ROPE

INOX



No.	rope diameter	length	
51120	Ø 1 mm	300 m	1
51121	Ø 1,2 mm	300 m	1
51122	Ø 1,5 mm	300 m	1
51123	Ø 2 mm	200 m	1
51124	Ø 3 mm	200 m	1
51125	Ø 4 mm	100 m	1
51126	Ø 5 mm	75 m	1
51127	Ø 6 mm	75 m	1

STAND FOR ROPES, STAND FOR CHAINS

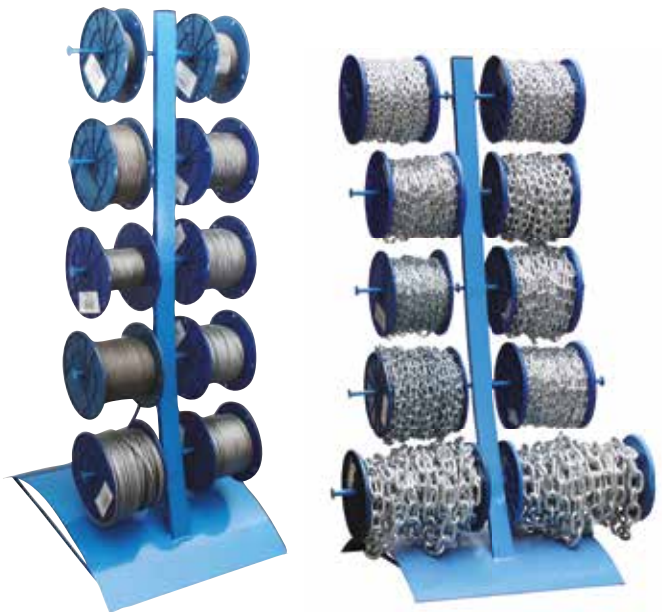

No.	specification	
51196	Promotional stand for chains staffed	10
51197	Promotional stand for ropes staffed	10
51198	Promotional stand for chains	10
51199	Promotional stand for ropes	10

HAND WINCH WITH WIRE ROPE AND HOOK

Zn



No.	load capacity	rope length	
26720	300 kg	8 m	1
26705	450 kg	8 m	1
26721	500 kg	8 m	1
26722	800 kg	8 m	1
26706	900 kg	8 m	1
26707	1350 kg	8 m	1

LED LAMP ON BUILDING SITE



No.	specification
37611	1



HALOGEN LAMP



No.	specification	
37600	120 W	1
37601	400 W	1

HALOGEN LIGHT BULB



No.	specification	
37604	120 W	1
37606	250 W	1
37605	400 W	1

LED LAMP ON BUILDING SITE



· max height 180 cm

No.	specification	
37615	20 W	1
37616	2 x 20 W	1



HALOGEN LAMP FOR BUILDING SITE

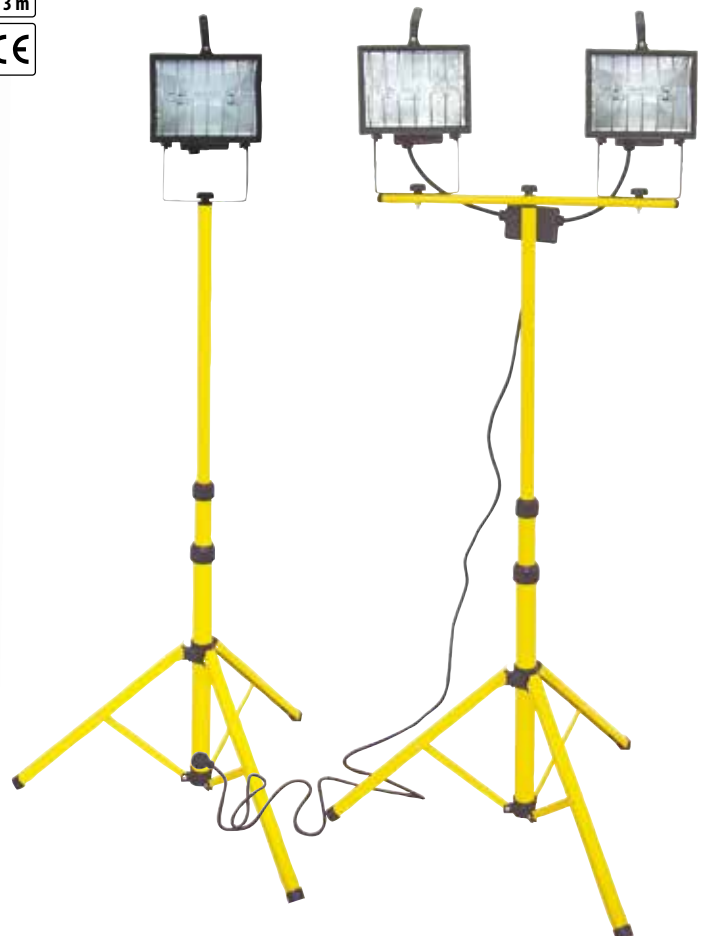

· max height 180 cm

No.	specification	
37602	400 W	2
37603	2 x 400 W	2



TELESCOPIC LADDER

ALU

CE EN
131

· max. load 150 kg

No.	specification	
48410	3,2 m 11 steps	1
48411	3,8 m 13 steps	1

WORK PLATFORM, FOLDABLE

ALU



· max. load 150 kg

No.	specification	
48420		1

SUPPORTING POLE

FESTA

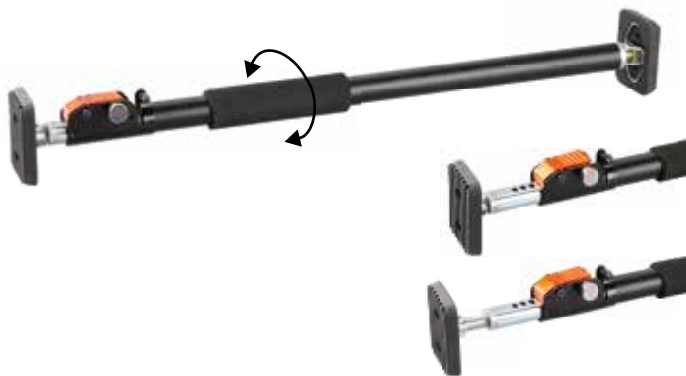

· max. load 40 kg

No.	specification	
52060	66 - 115 cm	1
52065	160 - 290 cm	1

TELESCOPIC LADDER FOLDABLE

ALU

CE EN
131

· max. load 150 kg

No.	specification	
48415	1,9 / 3,8 m 6/12 steps	1

ADJUSTABLE PROPS

MADE IN
EU

· 48449 cage for adjustable props

No.	specification	
48452	160 - 290 cm	1
48453	180 - 320 cm	1
48454	200 - 360 cm	1
48455	250 - 440 cm	1
48456	260 - 380 cm	1
48457	220 - 400 cm	1

SUPPORTING POLE



No.	specification	
52050	50 - 115 cm	1
52055	115 - 290 cm	1

WOOD SCREWS IN BOX

310x



pcs	content
60	3,0 x 12 mm
50	3,0 x 16 mm
40	3,0 x 20 mm
50	3,5 x 20 mm
40	3,5 x 30 mm
25	4,0 x 30 mm
20	4,0 x 40 mm
15	5,0 x 50 mm
10	5,0 x 60 mm



No. specification
55642

WOOD SCREWS AND WALL DOWELS IN BOX

170x



wood screws	
pcs	content
40	3,5 x 30 mm
25	4,0 x 40 mm
12	5,0 x 50 mm
8	6,0 x 60 mm

wall dowels	
pcs	content
40	5 x 25 mm
25	6 x 30 mm
12	8 x 40 mm
8	10 x 50 mm



No. specification
55645

WOOD SCREW

2000x



pcs	content
350	3,0 x 16 mm
280	3,0 x 20 mm
220	3,0 x 25 mm
250	3,5 x 20 mm
240	3,5 x 25 mm
180	3,5 x 3, mm
280	4,0 x 16 mm
80	4,0 x 30 mm
40	4,0 x 40 mm
30	4,0 x 50 mm
25	5,0 x 50 mm
25	5,0 x 60 mm



No. specification
55640 2000 pcs

CHIMNEY DOORS TIN



CHIMNEY DOORS KOMAX



CHIMNEY DOORS GALVANIZED



No. specification
65062



No. specification
65063 grey
65064 white



No. specification
65065





294

WINLAND GARDEN PRUNERS



298

GARDEN PRUNERS



301

GARDEN SAWS



302

MACHETES AND GARDEN TOOLS



303

GARDEN TOOLS



305

TRIMMER LINES



306

SHARPENERS

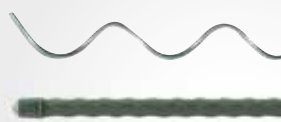

307

GARDEN SUPPORTING BAR



308

BONDED WEB FABRIC



310

WATERING SYSTEM AQUATIC AND ROSA



322

HOSE REELS AND HOSE CARTS



324

HOSE CONNECTORS BRAS



326

HOSE CONNECTORS



327

PRESURE SPRAYER AND COMPRESSORS



329

RAKE



334

SPADES, SHOVELS AND FORKS



340

HOES AND PICKAXES



343

BRUSHES



346

SNOW SHOVELS



347

WOODEN, ALU AND FIBERGLASS BUTT

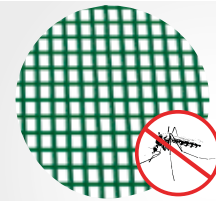

349

INSECT SCREEN

GARDEN TOOLS AND FENCING

292 - 357

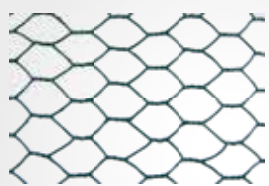

350

FENCES



352

POLE ANCHOR AND ANCHORAGE SCREW

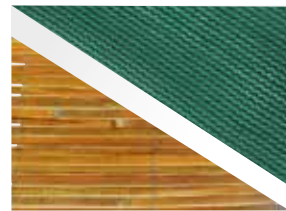

354

SHADING NETS, SPLITTED BAMBOO, REED-CANE



355

GRILL TOOLS





PRUNERS

- professional garden pruners
- high quality used materials
- quality manufactured
- ergonomic grips

PRUNERS

SK5



- blade HCS SK - 5, Japanese steel



No.	specification	
45020	205 mm	10
44980	spare spring	1

PRUNERS

SK5



- blade HCS SK - 5, Japanese steel



No.	specification	
45023	205 mm	10
44980	spare spring	1

PRUNERS

SK5



- blade HCS SK - 5, Japanese steel



No.	specification	
45063	215 mm	10
44981	spare spring	1

PRUNERS

SK5

TEFLON



- blade HCS SK - 5, Japanese steel



No.	specification	
44972	215 mm	10
44981	spare spring	1

PRUNERS

SK5



No. specification

45099 190 mm

44983 spare spring

10
1

PRUNERS

SK5



No. specification

45098 220 mm

44983 spare spring

10
1

PRUNERS

SK5

TEFLON



No. specification

45095 200 mm

44982 spare spring

10
1

PRUNERS

SK5

NYLON



· blade HCS SK - 5, Japanese steel
· nylon handle

No. specification

45064 210 mm

44983 spare spring

10
1

PRUNERS

SK5

TEFLON

· turning handle



· blade HCS SK - 5, Japanese steel

No. specification

45096 220 mm

44982 spare spring

6
1

PRUNERS

SK5

TEFLON



· blade HCS SK - 5, Japanese steel

No. specification

45097 250 mm

44981 spare spring

10
1

PRUNERS

INOX



No. specification

45089 160 mm

10

PRUNERS

INOX



No. specification

45088 160 mm

10

PRUNERS

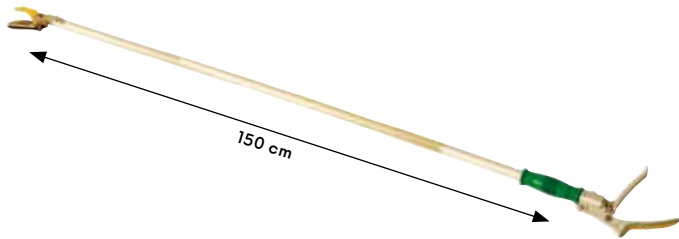

No.	specification
45017	

10

SPARE BLADE

SK5

TEFLON



· for pruners 45095, 45027

No.	specification
45094	

20

PRUNERS FOR BRANCHES

∅ max. 45mm

SK5

TEFLON



· blade HCS SK - 5, Japanese steel

No.	specification
44991	76 cm



12

PRUNERS FOR BRANCHES TELESCOPIC

∅ max. 45mm

SK5

TEFLON



· blade HCS SK - 5, Japanese steel

No.	specification
44992	70 - 103 cm



10

SPARE SPRING



No.	for pruners	
44981	45021, 45025, 45063, 45097	1
44980	45020, 45023	1
44983	45098, 45099	1
44982	45027, 45095, 45096	1
44984	45110, 45014, 45026	1
44985	45018	1
44986	45019, 45029, 44970	1
44987	45021	1
44988	44971	1
44989	45015, 45016	1

PRUNERS FOR BRANCHES



PRUNERS

TEFLON



No.	specification
44996	61 cm, wavy edge



12

PRUNERS

TEFLON



No.	specification	
44997	61 cm, straight edge	12

SHEARS GRASS 360°



No.	specification	
44998		6

SHARPENER FOR SCISSORS AND KNIVES 6 IN 1



No.	specification	
45068		10

SHARPENER FOR SCISSORS AND KNIVES



No.	specification	
45048		20

PRUNERS

INOX



No.	specification	
45010	190 mm	12
44984	spare spring	1

PRUNERS

INOX



No.	specification	
45014	190 mm	12
44984	spare spring	1

PRUNERS

INOX



No.	specification	
45026	150 mm	12
44985	spare spring	1

PRUNERS



No.	specification	
45018	210 mm metal tipped	10

PRUNERS

SK5

TEFLON



No. specification
45019 210 mm

10

PRUNERS

FESTA

SK5

TEFLON

NYLON



No. specification
45021 200 mm

6

nylon handle

PRUNERS

ALU



No. specification
45025 200 mm

12

PRUNERS

INOX



No. specification
44970 210 mm

10

PRUNERS

TEFLON



No. specification
45027 200 mm

10

PRUNERS

INOX

ALU



No. specification
45029 200 mm

24

PRUNERS

INOX



No. specification
44971 160 mm

10

PRUNERS



No. specification
45016 180 mm

12

PRUNERS



No. specification
45015 190 mm, straight

12

CASE FOR GARDEN PRUNERS



No. specification
37317

1

GRASS SHEARS



No. specification
45011 300 mm

1

GRASS SHEARS



No. specification
45012 370 mm, turning 180°

1



PRUNERS FOR BRANCHES

TEFLON

NYLON



· nylon handle

No. specification
44999 540 mm, round

12

PRUNERS FOR BRANCHES

TEFLON

FESTA



No. specification
45000 750 mm, round

6

PRUNERS FOR BRANCHES

TEFLON

FESTA



No. specification
45001 710 mm, round

6

PRUNERS FOR BRANCHES



TEFLON



No. specification
45002 750 mm, with ratchet

12

PRUNERS FOR BRANCHES, TELESCOPIC



TEFLON



No. specification
45003 660-900 mm, telescopic

6

PRUNERS

TEFLON



No. specification
44995 440 | 160 mm

12

PRUNERS FOR BRANCHES



TEFLON



No. specification
45005 580 | 230 mm, wavy edge

6

PRUNERS



No. specification
45009 500 | 190 mm, wavy edge

6

PRUNERS FOR BRANCHES



TEFLON



No. specification
45006 580 | 230 mm, straight edge

6

PRUNERS



No. specification
45008 500 | 190 mm, straight edge

6

PRUNERS FOR BRANCHES TELESCOPIC



TEFLON



No. specification
45007 670-870 | 230 mm, wavy edge

6

FOLDING SAW



· 3 x sharpened and heat treated teeth

No.	specification
45061	150 mm



12

FOLDING SAW



· 3 x sharpened and heat treated teeth

No.	specification
45060	180 mm



6

SAW WITH CASE



· 3 x sharpened and heat treated teeth

No.	specification
45062	260 mm



24

PRUNING HAND SAW



· 3 x sharpened and heat treated teeth

No.	specification
24152	300 mm



12

TELESCOPIC POLE SAW



· 3 x sharpened and heat treated teeth

No.	specification
45033	230 - 490 cm 340 mm



1

CATTERPILAR WITH SAW



No.	specification
45030	saw 300 mm telescopic pole 240 cm
45031	saw 300 mm

6
6

CATTERPILAR



No.	specification
45032	metal caterpillar without saw

10



MACHETE

TEFLON



No.	specification	
45069	440 mm	6

FESTA®

MACHETE

TEFLON



No.	specification	
44950	490 mm	16

FESTA®

MACHETE STAINLESS STEEL

INOX



No.	specification	
45083	430 mm	12
45084	600 mm	6

MACHETE



handle made out of ash wood

No.	specification	
45081	510 mm	36
45082	710 mm	36

SHOVEL STAINLESS

INOX



No. specification
45056 360 mm



SHOVEL NARROW STAINLESS

INOX



No. specification
45057 350 mm



HACK STAINLESS

INOX



No. specification
45058 270 mm



HACK STAINLESS

INOX



No. specification
45059 370 mm



SHOVEL NYLON

NYLON



No. specification
45065 280 mm



SHOVEL NARROW NYLON

NYLON



No. specification
45066 310 mm



FORK NYLON

NYLON



No. specification
45067 290 mm



TOOLS

HOBBY

4x



No. specification
45035 240 mm



"T" PLANTING DOSSIL



No.	specification	
45038	280 mm	60

PLUCKING FOR WEED



No.	specification	
44955	950 mm	16

NOŽ ZA KOROV



Č.p.	specifikace	
45079	200 mm	1

NOŽ ZA KOROV



Č.p.	specifikace	
45080	200 mm „L“	1

FOLDING SHOVEL 3 IN 1



case

No.	specification	
61085	410 mm	25

BULB PLANER

INOX



No.	specification	
45040	230 mm	60

FRUIT PICKER



No.	specification	
45041		75

FRUIT PICKER



No.	specification	
45039		50
45034	170 - 300 cm, telescopic but	5



TRIMMER LINES FOW LAWN MOVER

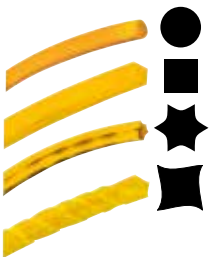

No.	specification		
45500	1,3 mm x 15 m	●	30
45502	1,3 mm x 15 m	★	30
45503	1,6 mm x 15 m	●	20
45505	1,6 mm x 15 m	★	20
45506	2 mm x 15 m	●	12
45508	2 mm x 15 m	★	12
45517	2 mm x 15 m	■	10
45509	2,4 mm x 15 m	●	12
45511	2,4 mm x 15 m	★	12
45512	2,4 mm x 15 m	■	12
45518	2,4 mm x 15 m	■	10
45523	2,7 mm x 15 m	●	10
45524	2,7 mm x 15 m	★	10
45513	3 mm x 15 m	●	10
45515	3 mm x 15 m	★	10
45516	3 mm x 15 m	■	10
45519	3 mm x 15 m	■	10

TRIMMER LINES FOW LAWNMOVER WITH NYLON CENTER



No.	specification		
45530	2 mm x 15 m	■	1
45531	2,4 mm x 15 m	■	1
45532	3 mm x 15 m	■	1
45533	3,15 mm x 15 m	■	1
45534	4 mm x 15 m	■	1

TRIMMER LINES FOW LAWN MOVER



No.	specification		
45520	2 mm x 162 m	●	10
45521	2,4 mm x 112 m	●	10
45528	2,7 mm x 90 m	●	10
45522	3 mm x 72 m	●	10
45525	2 mm x 162 m	★	10
45526	2,4 mm x 112 m	★	10
45529	2,7 mm x 90 m	★	10
45527	3 mm x 72 m	★	10

WHETSTONE



No.	specification	
45046	205 x 15 mm	100

WHETSTONE OVAL



No.	specification	
45370	250 x 33 x 18 mm	20

WHETSTONE



No.	specification	
45045	150 x 50 x 30 mm	50

SHARPENER FOR KNIVES AND SCISSORS 6 IN 1



No.	specification	
45068		10

SHARPENER FOR KNIVES AND SCISSORS



No.	specification	
45048		20

SHARPENER FOR KNIVES AND SCISSORS



No.	specification	
16990	Ø 50 mm	50

SHARPENER FOR KNIVES AND SCISSORS



No.	specification	
16991		20

BINDING TAPE

3x



No.	specification	
45472	3 cm x 3 m, 3 pcs	36

BINDING TAPE



No.	specification	
45473	3 cm x 50 m	60

BINDING TAPE, VELCRO



No.	specification	
45471	12 mm x 5 m	1

BINDING WIRE



No.	specification	
45043	30 m	30

BINDING WIRE RUBBER COATING



No.	specification	
23845	3 mm x 8 m	30
23846	4 mm x 6 m	30
23847	5 mm x 4 m	30

GARDEN BAR FIBERGLASS



No.	specification	
45036	180 cm Ø 7,9 mm	100

BINDING TAPES - TOOTHED

50x



No.	specification	
23840		20

SPIRAL GARDEN BAR

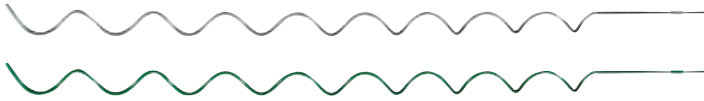

No.	specification	
44041	1,2 m, Ø 5,5 mm komaxit - green	10
44042	1,5 m, Ø 6 mm komaxit - green	10
44043	1,8 m, Ø 6 mm komaxit - green	10
45049	1,8 m, Ø 7 mm komaxit - green	10
45044	1,8 m, Ø 7 mm komaxit - silver	10
44050	2,2 m, Ø 7 mm komaxit - green	10

GARDEN BAR FIBERGLASS



No.	specification	
45670	8 mm	10
45671	11 mm	10
45672	16 mm	10
45673	20 mm	10

GARDEN BAR



No.	specification		No.	specification		No.	specification	
45650	90 cm Ø 8 mm	25	45655	150 cm Ø 11 mm	25	45659	180 cm Ø 16 mm	25
45651	120 cm Ø 8 mm	25	45656	180 cm Ø 11 mm	25	45660	210 cm Ø 16 mm	25
45652	150 cm Ø 8 mm	25	45661	210 cm Ø 11 mm	25	45662	150 cm Ø 20 mm	10
45653	90 cm Ø 11 mm	25	45657	120 cm Ø 16 mm	25	45663	180 cm Ø 20 mm	10
45654	120 cm Ø 11 mm	25	45658	150 cm Ø 16 mm	25	45664	210 cm Ø 20 mm	10



CUCUMBER NET

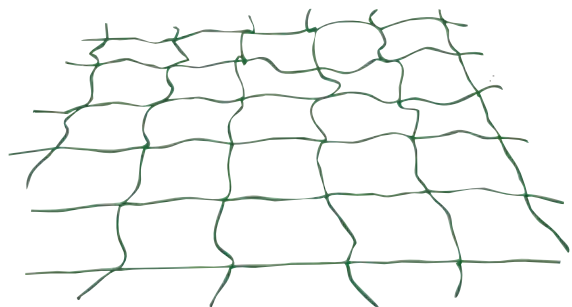

No.	specification	eye size	
45560	2 x 10 m	10 x 10 cm	100

BONDED WEB FABRIC WITH SECTIONS FOR PLANTS



45 g/m²

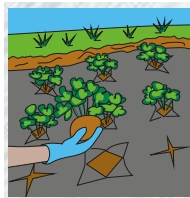

No.	specification	
45535	1,6 x 5 m	18

MULCHING FABRIC



50 g/m²



No.	specification	
45550	1,6 x 5 m	50
45551	1,6 x 10 m	20
45564	3,2 x 10 m	20
45552	1,6 x 50 m	in roll 1
45553	1,6 x 100 m	in roll 1
45562	3,2 x 50 m	in roll 1
45563	3,2 x 100 m	in roll 1

MULCHING FABRIC



50 g/m²



No.	specification	
45556	1,6 x 5 m	50
45557	1,6 x 10 m	20
45565	3,2 x 10 m	20
45558	1,6 x 50 m	in roll 1
45559	1,6 x 100 m	in roll 1

BONDED WEB FABRIC WHITE



17 g/m²



No.	specification	
45540	1,6 x 5 m	40
45541	1,6 x 10 m	40
45542	1,6 x 50 m	in roll 1
45543	1,6 x 100 m	in roll 1

PIN FOR ATTACHING MULCHING FABRIC

10x



No.	specification	
45555	11,5 cm	1

GARDEN FOLDING CHAIR



• for sitting and upside down for kneeling

No.	specification	
45074	58 x 48 x 28 cm	4



KNEELER



No.	specification	
45086	40 x 18 x 2 cm	50

CULTIVATOR



No.	specification	
45042	160 x 132 cm	12

CULTIVATOR



No.	specification	
44053		12
61251	160 cm handle	1

SPREADING CART

dimensions	
height:	111 cm
wide:	55 cm
volume:	12 l



No.	specification	
45085	12 l	1

BUCKET



No.	specification	
39192	30 l	20
39193	45 l	20

FOLDING BASKET FOR LEAVES



No.	specification	
45047	55 x 70 cm, 3 handles	20

FOLDING BASKET



No.	specification	
45093	40 x 25 x 23 cm	20

FOLDING BASKET FOR LEAVES



No.	specification	
44960	200 l 60 x 60 x 55 cm	1

- PROFESSIONAL WATERING ASSORTMENT
- QUALITY MATERIALS AND PROCESSING
- MODERN DESIGN
- COMPATIBLE WITH ROSA PRODUCTS



SPRAY GUN



- 7 functions
- front trigger with lock
- effortless flow control

No. specification

45386



SPRAY GUN



- adjustable flowing
- front trigger with lock
- effortless flow control

No. specification

45388



SPRINKLER



- adjustable flowing

No. specification

45389



HOSE BASIC SET



- adjustable flowing

No. specification

45385

pcs



HOSE CONNECTOR



No. specification

45390

24

HOSE CONNECTOR



No. specification

45391

24

HOSE CONNECTOR



No. specification

45392

24

HOSE CONNECTOR



No. specification

45393

24

STOP HOSE CONNECTOR



No. specification

45394

24

STOP HOSE CONNECTOR



No. specification

45395

24

ADAPTOR



No. specification

45396

24

ADAPTOR



No. specification

45397

24

SPRINKLER



- 2bar min
4bar max
- Max
27L/min
- 318m²

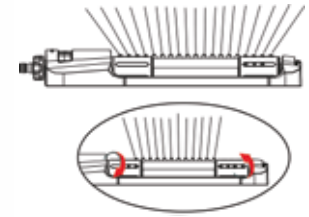

• 19 nozzles with 8 switchable (on/off) spray nozzles



No. specification
45398



6

SPRINKLER



- 4bar max
- Max
30L/min
- 360°
- R 6m
113m²



• adjustable arms with nozzles

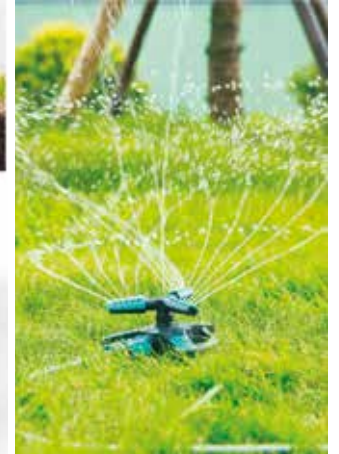

No. specification
45399



12

WATER DISTRIBUTOR



- 3/4"
- 1"



• adjustable flow control



No. specification
45400 2 way



6



WATER DISTRIBUTOR



- 3/4"
- 1"



• adjustable flow control



No. specification
45401 4 way



6





ROSA

Watering system



SPRAY GUN 

0,7 bar min
5,5 bar max



- 10 functions
- front trigger with lock

No. specification

45124  12

SPRAY GUN 

0,7 bar min
5,5 bar max



- 10 functions
- trigger with lock
- effortless flow control

No. specification

45125  12

SPRAY GUN 

0,7 bar min
5,5 bar max



- 7 functions
- trigger with lock

No. specification

45126  12

SPRAY GUN, DELUX 

0,7 bar min
5,5 bar max



- 7 functions
- trigger with lock
- effortless flow control

No. specification

45123 kovová | metal  12

SPRAY GUN 

0,7 bar min
5,5 bar max



- 6 functions
- trigger with lock
- effortless flow control

No. specification

45117  12

SPRAY GUN, DELUX 

0,7 bar min
5,5 bar max



- 6 functions
- trigger with lock
- effortless flow control

No. specification

45118 kovová hlavice | metal head  12

SPRAY GUN



0,7 bar min
5,5 bar max



- 5 functions
- trigger with lock
- effortless flow control



No. specification

45110



12

SPRAY GUN



0,7 bar min
5,5 bar max



- rose gun
- effortless flow control



No. specification

45116



12

SPRAY GUN



0,7 bar min
5,5 bar max



- metal head
- trigger with lock
- effortless flow control



No. specification

45120



12

SPRAY GUN



0,7 bar min
5,5 bar max



- trigger with lock
- effortless flow control



No. specification

45115



12

SPRAY GUN



0,7 bar min
5,5 bar max



- metal
- trigger with lock
- effortless flow control



No. specification

45122 metal



12

SPRAY GUN SET



0,7 bar min
5,5 bar max

1/2"

2x



- trigger with lock
- effortless flow control



No. specification

45114 1/2 hose connector



12

SPRAY GUN



0,7 bar min
5,5 bar max



- trigger with lock
- effortless flow control



No. specification

45111



12

SPRINKLER



0,7 bar min
5,5 bar max



- adjustable flowing



No. specification

45113



60

SPRINKLER



0,7 bar min
5,5 bar max



- stream lined, classic connection



No. specification

45112



32

SPRAY GUN SET



0,7 bar min
5,5 bar max



4x



- 6 functions
- trigger with lock
- effortless flow control



No. specification

45181



12

SET WITH SPRAY GUN



0,7 bar min
5,5 bar max



4x



- adjustable flowing



No. specification

45180



12

Y - SWITCH COUPLING SWIVEL



0,7 bar min
5,5 bar max



- with water valve



No. specification

45134



12

HOSE MENDER



10 bar max



No. specification

45140



60

HOSE MENDER



10 bar max



MOQ 20



No. specification

45296

MOQ 20

HOSE CONECTOR



10 bar max



No. specification

45142



60

HOSE CONECTOR



10 bar max



MOQ 20



No. specification

45298

MOQ 20

STOP HOSE CONECTOR



No. specification
45138



STOP HOSE CONECTOR



No. specification
45294

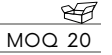

HOSE CONECTOR



No. specification
45141



HOSE CONECTOR



No. specification
45297

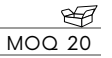

HOSE CONECTOR



No. specification
45143



HOSE CONECTOR



No. specification
45299

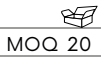

STOP HOSE CONECTOR



No. specification
45139



STOP HOSE CONECTOR



No. specification
45295



ADAPTER



No.	specification	
45130	1/2" + 3/4"	60
45131	3/4" + 1"	60

ADAPTER



MOQ 20



No.	specification	
45289	1/2" + 3/4"	MOQ 20
45290	3/4" + 1"	MOQ 20

HOSE CONNECTOR SET



2x



No.	specification	
45144		60

REDUCTION 1/2" - 3/4"



No.	specification	
45213	1/2" - 3/4"	60

ONE-WAY SWITCH COUPLING



No.	specification	
45135	with water valve	60

ADAPTER



No.	specification	
45145		60

ADAPTER



No.	specification	
45132		60

ADAPTER



MOQ 20



No.	specification	
45291		MOQ 20

ADAPTER



ADAPTER



MOQ 20



No. specification



45133

60

No. specification



45292

MOQ 20

ADAPTER



ADAPTER



MOQ 20



No. specification



45136

60

No. specification



45293

MOQ 20

ADAPTER



ADAPTER



No. specification



45137

60

No. specification



45215

48

HOSE CONNECTOR



HOSE CONNECTOR



No. specification



45218

48

No. specification



45219

48

REDUCTION 3/4" - 1"

ROSA



No. specification
45216

48

ADAPTER

ROSA



No. specification
45217

48

SALES SET

ROSA

225x



content of set

- 45113 15 ks
- 45117 10 ks
- 45120 15 ks
- 45132 40 ks
- 45131 40 ks
- 45133 40 ks
- 45142 25 ks
- 45143 20 ks
- 45140 20 ks

No. specification
45146

1

SPRINKLER

ROSA



adjustable flowing
No. specification
45214

48

SPRINKLER, IMPULS

ROSA



impulse
No. specification
45162

24

SPRINKLER

ROSA



function
No. specification
45154

48

SPRINKLER

ROSA



rotary
2 arms
No. specification
45153

24

SPRINKLER

ROSA



rotary
3 arms
No. specification
45152

24

SPRINKLER SWINGING



0,7 bar min
5,5 bar max

ALU



· 17 jets ALU

No. specification
45158



6

SPRINKLER



0,7 bar min
5,5 bar max



· pyramidal

No. specification
45167



12

SPRINKLER



0,7 bar min
5,5 bar max



· point

No. specification
45160



25

SPRINKLER



0,7 bar min
5,5 bar max



· pot sprinkler with valve

No. specification
45156



12

STAND FOR IMPULSE SPRINKLER



0,7 bar min
5,5 bar max

3/4"



No. specification
45155



24

SPLINKER, IMPULSE



0,7 bar min
5,5 bar max



· tripod

No. specification
45163 impulse, tripod



20

WATER TIMER



0,7 bar min
5,5 bar max

3/4"



· 0 - 120 min.

No. specification
45147



24

SPRINKLER, IMPULS



0,7 bar min
5,5 bar max

3/4"



· brass

No. specification
45150



12

SPRINKLER, IMPULSE

ROSA

0,7 bar min
5,5 bar max

3/4"



No. specification
45151

12

SPRINKLER, IMPULSE, POINT

ROSA

0,7 bar min
5,5 bar max

3/4"



No. specification
45168 plastic point
45169 metal point

12
12

SPRINKLER, IMPULSE, POINT

ROSA

0,7 bar min
5,5 bar max



No. specification
45161 plastic point

20

SPRINKLER, ROTARY, POINT

ROSA

0,7 bar min
5,5 bar max

3/4"



- 3 arms
- two-ways

No. specification
45164 plastic point

12

SPIKE STAND

ROSA

Zn

3/4"



No. specification
45159

12

SPIKE STAND

ROSA

3/4"



No. specification
45179

12

HOSE GUIDE

ROSA



No. specification
45186

48

SPRINKLER, IMPULS

ROSA

1"



20

No. specification
45185

SPRINKLER, IMPULS

ROSA

3/4"



20

No. specification
45184

SEL SET



• for items

- 45110, 45111, 45118,
- 45120, 45121, 45123,
- 45125, 45126, 45130,
- 45131, 45132, 45134,
- 45135, 45152, 45153,
- 45154, 45155, 45156,
- 45162, 45177, 45178,
- 45180, 45196, 45197,
- 45198

No. specification
45175



1

SEALING RING



50x



No. specification
45187



1

HOSE REEL



No. specification
45182 1/2" 40 m



4

AUTO REWIND HOSE REEL



No. specification
45176

• hose included 1/2" 20 m



1

HOSE CART METAL



HOSE CART



HOSE HOLDER



No. specification
45183 1/2" 60 m



5



No. specification
45177 1/2" 60 m



5



No. specification
45178 1/2" 60 m



5

SHOWER



SHOWER



HAND SHOWER



0,7 bar min
5,5 bar max



0,7 bar min
5,5 bar max



0,7 bar min
5,5 bar max



No.	specification	
45171	adjustable	12

No.	specification	
45170	tripod	6

No.	specification	
45172	with valve	12
45173	10 function	12

HOSE CARRIER



GARDEN HOSE CLEAR



GARDEN HOSE OPAQUE



No.	specification	
45174		60

No.	specification	
45345	1/2" 25 m	1
45349	3/4" 25 m	1
45353	1" 25 m	1

No.	specification	
45360	1/2" 25 m	1
45364	3/4" 25 m	1
45366	1" 25 m	1

SPIRAL HOSE - SET



HOSE CARRIER

0,7 bar min
5,5 bar max

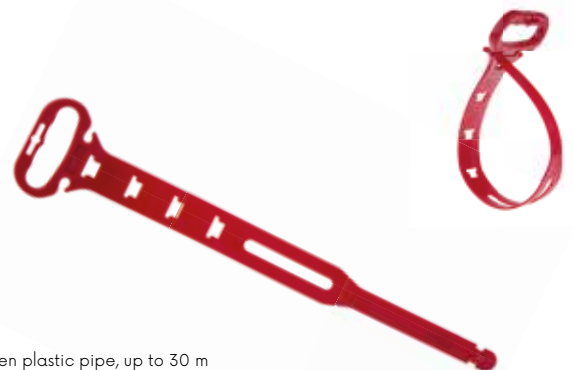

No.	specification	
45300	7,5 m	6
45301	15 m	8

· 1/2" garden plastic pipe, up to 30 m

No.	specification	
45350	Max. holding capacity 20 kg	1

HOSE MENDER BRASS



0,7 bar min
13,8 bar max

1/2"



No. specification



45192

48

HOSE CONNECTOR BRASS



0,7 bar min
13,8 bar max

1/2"



No. specification



45194

48

STOP HOSE CONNECTOR BRASS



0,7 bar min
13,8 bar max

1/2"



No. specification



45190

48

HOSE MENDER BRASS



0,7 bar min
13,8 bar max

3/4"



No. specification



45193

48

HOSE CONNECTOR BRASS



0,7 bar min
13,8 bar max

3/4"



No. specification



45195

48

STOP HOSE CONNECTOR BRASS



0,7 bar min
13,8 bar max

3/4"



No. specification



45191

48

ADAPTER BRASS



0,7 bar min
13,8 bar max

1/2"

3/4"



No. specification



45196

with inward scroll 1/2" + 3/4"

48

ADAPTER BRASS



0,7 bar min
13,8 bar max

3/4"



No. specification



45197

with inward scroll 3/4"

48

ADAPTER BRASS



0,7 bar min
13,8 bar max

1"



No. specification



45199

with inward scroll 1"

48

ADAPTER BRASS



0,7 bar min
13,8 bar max

3/4"

1"



No. specification



45198

with inward scroll 3/4 + 1"

48

ADAPTER BRASS



0,7 bar min
13,8 bar max

3/4"



No. specification



45200

with outward scroll 3/4

48

ADAPTER BRASS



0,7 bar min
13,8 bar max



No. specification



45206

adjustable

48

ADAPTER BRASS



ADAPTER BRASS



HOSE ADAPTER WITH BRASS THREAD



No.	specification	
45203	connection for 2 hose connectors	48

No.	specification	
45204	connection for 3 hose connectors	48

No.	specification	
45211	inner thread 1"	25

HOSE MENDER



No.	specification	
45220	1/2" thread 3/4"	10
45221	3/4" thread 1"	10
45222	1" thread 1"	10

HOSE END



No.	specification	
45223	1/2" thread 3/4"	10
45224	3/4" thread 1"	10
45225	1" thread 1"	10

HOSE REDUCTION



No.	specification	
45226	1/2" - 3/4" thread 1"	10
45227	1" - 3/4" thread 1"	10
45228	1" - 1/2" thread 1"	10

SPRINKLER



No.	specification	
45229		10

HOSE CLAMP

Zn



No.	diameter	
45603	16 - 25 mm	100
45604	20 - 32 mm	100
45605	25 - 40 mm	100
45606	30 - 45 mm	100
45607	32 - 50 mm	100
45608	40 - 60 mm	100
45609	50 - 70 mm	100
45610	60 - 80 mm	50
45611	70 - 90 mm	50
45612	80 - 100 mm	50
45613	90 - 110 mm	50
45614	100 - 120 mm	50
45615	110 - 130 mm	50
45616	120 - 140 mm	50
45617	130 - 150 mm	50
45618	140 - 160 mm	50
45619	150 - 170 mm	50

No.	diameter	
45600	8 - 12 mm	100
45601	10 - 16 mm	100
45602	12 - 20 mm	100

HOSE CLAMP

INOX



No.	diameter	width	
45623	16 - 25 mm	9 mm	100
45624	20 - 32 mm	9 mm	100
45625	25 - 40 mm	12 mm	100
45626	30 - 45 mm	12 mm	100
45627	32 - 50 mm	12 mm	100
45628	40 - 60 mm	12 mm	100
45629	50 - 70 mm	12 mm	100
45630	60 - 80 mm	12 mm	100
45631	70 - 90 mm	12 mm	100
45632	80 - 100 mm	12 mm	50
45633	90 - 110 mm	12 mm	50
45634	100 - 120 mm	12 mm	50
45635	110 - 130 mm	12 mm	50
45636	120 - 140 mm	12 mm	50
45637	130 - 150 mm	12 mm	50
45638	140 - 160 mm	12 mm	50
45639	150 - 170 mm	12 mm	50

No.	diameter	width	
45620	8 - 12 mm	9 mm	100
45621	10 - 16 mm	9 mm	100
45622	12 - 20 mm	9 mm	100



GARDEN VALVES AND GARDEN EWERS

DOUBLE WATER VALVE



No.	specification	
45105		8

GARDEN VALVE



No.	specification	
45100	1/2"	12
45101	3/4"	10
45102	1"	6

BALL VALVE

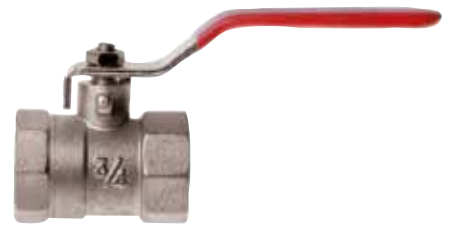

No.	specification	
45106	1/2"	12
45107	3/4"	10
45108	1"	8

CORNER VALVE



No.	specification	
45104	1/2" x 3/8"	10

WATERING CAN PLASTIC



No.	specification	
45280	2,5 l	10
45283	5 l	10
45285	10 l	10
45286	12 l	10
45287	15 l	10





PRESSURE SPRAYER 12 L



max. pressure: **2,5 Bar**
 volume: **12 l**
 length of hose **3 m**
 dimensions: **32 x 25 x 59 cm**



No.	specification	
45249	pressure sprayer 12 l	1
45273	spare nozzle	1
45274	spare pressure hose	1

HIGH PRESSURE CLEANER



voltage | frequency : **230 V/50 Hz**
 power consumption : **1500 W**
 max. pressure : **120 Bar**
 work pressure : **80 Bar**
 flow of water : **6 l**
 length of hose : **5 m**
 protection : **IPX5**
 function : **Auto Stop**



No.	specification	
45270	high pressure cleaner	1
45271	spare nozzle	1
45272	spare pressure hose	1

PRESSURE SPRAYER



No.	specification	
45247	12 l	1
45248	16 l	1

No.	specification	
45263	spare hose	1
45251	spare set of selling	1
45254	spare nozzle	1
45257	spare handle	1
45260	spare pole - 370 mm	1
45267	spare pole 45 - 250 cm	1
45268	spare pole 65 - 260 cm	1

PRESSURE SPRAYER



No.	specification	
45244	3 l	6
45245	5 l	6
45246	8 l	6

No.	specification	
45262	spare hose	1
45250	spare set of selling	1
45253	spare nozzle	1
45256	spare handle	1
45261	spare pole - 370 mm	1

PRESSURE HAND SPRAYER



HAND SPRAYER



No.	type	
45242	1,5 l	20
45241	2 l	20

No.	type	
45239	0,5 l	1
45240	0,7 l	1

TELESCOPIC POLE FOR PRESSURE SPRAYER

TELESCOPIC SPRINKLER

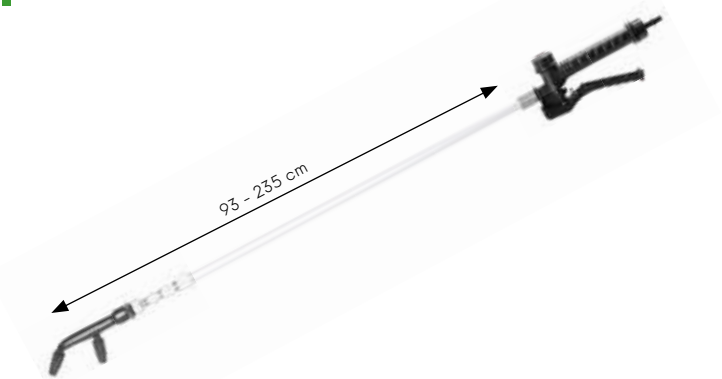

No.	type	
45267	45 - 250 cm inox	1
45268	65 - 260 cm fiberglass	1

No.	specification	
45269		1

SPARE HOSE FOR PRESSURE SPRAYER

SUBMERSIBLE PUMP



power consumption :	400 W
voltage :	230 V 50 Hz
type of protection :	IPX 8
max. height flow :	5 m
rate :	8000 l h
grain size :	3,5 mm
max. submersion depth :	7 m
max. temp. of liquid :	35°C
pipe connection :	1", G1", 1/4", G1/2"
cable length :	10 m

No.	type	
45263	for sprayer 45247, 45248	1
45262	for sprayer 45244, 45245, 45246	1

HERBICID BELL



No.	size	length	width	height	
45265	small	230 mm	90 mm	130 mm	1
45266	big	370 mm	140 mm	200 mm	1

No.	operation	
35350	400 W	1

FESTA®

**HRÁBĚ
RAKES**



PLASTIC RAKE

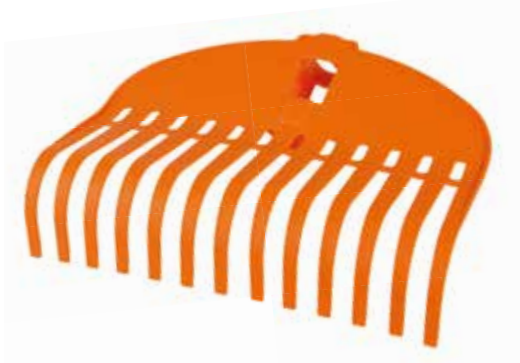

No.	no. lamellas	width	výška height	
45327	13	240 mm	200 mm	12

SET PLASTIC RAKE, ALUMINIUM HANDLE

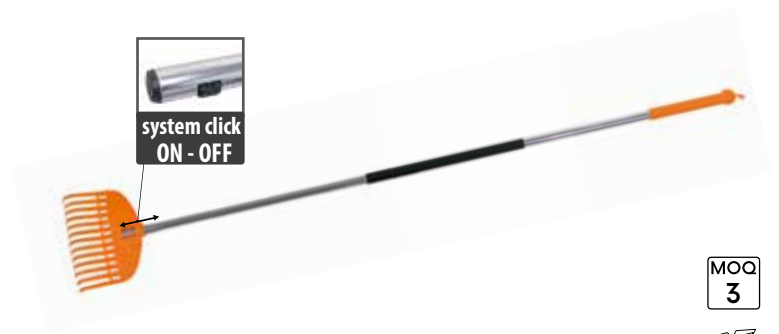

No.	no. lamellas	length of handle	
61136	13	160 cm	3
61147	13	100 cm	3

PLASTIC RAKE



No.	no. lamellas	width	výška height	
45328	23	480 mm	280 mm	12

SET PLASTIC RAKE, ALUMINIUM HANDLE



No.	no. lamellas	length of handle	
61137	23	160 cm	3
61148	23	100 cm	3

PLASTIC RAKE



No.	no. lamellas	width	výška height	
45329	35	760 mm	310 mm	1

SET PLASTIC RAKE, ALUMINIUM HANDLE



No.	no. lamellas	length of handle	
61138	35	160 cm	3

PLASTIC RAKE



No.	no. lamellas	width	
45325	12	410 mm	12

SET PLASTIC RAKE, ALUMINIUM HANDLE



No.	no. lamellas	length of handle	
61139	12	160 cm	3

MOQ
3

PLASTIC RAKE



No.	no. lamellas	width	
45326	18	580 mm	12

SET PLASTIC RAKE, ALUMINIUM HANDLE



No.	no. lamellas	length of handle	
61140	18	160 cm	3

MOQ
3

BRUSH



No.	dimensions	
45323	37 cm	16

SET BRUSH, ALU HANDLE



No.	dimensions	length of handle	
61149	37 cm	160 cm (45330)	3

MOQ
3

METAL RAKE ADJUSTABLE, TELESCOPIC



Zn



No.	no. lamellas	extent	
44965	15	200 - 590 mm	12

METAL RAKE ADJUSTABLE



Zn



No.	no. lamellas	váha weight	extent	
45050	15	1200 g	200 - 590 mm	25

METAL RAKE

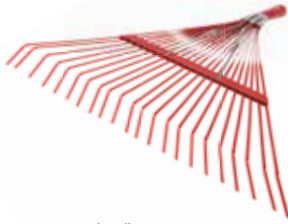

• spring steel

No.	width	no. lamellas	
45071	56 cm	22	1

METAL RAKE WITH HANDLE



MOQ
3

No.	width	length of handle	
61150	56 cm	160 cm	3

METAL RAKE



No.	width	no. lamellas	
45051	45 cm	22	60

METAL RAKE WITH HANDLE



MOQ
3

No.	width	length of handle	
61130	45 cm	160 cm	3

METAL RAKE - WIRE



No.	width	no. lamellas	
45052	45 cm	22	36

METAL RAKE WITH HANDLE



MOQ
3

No.	width	length of handle	
61131	45 cm	160 cm	3

PLASTIC RAKE



No.	width	no. lamellas	
45320	60 cm	24	10

PLASTIC RAKE WITH HANDLE



MOQ
3

No.	width	no. lamellas	length of handle	
61132	60 cm	24	160 cm	3

PLASTIC RAKE



No.	width	no. lamellas	
45055	50 cm	22	10

PLASTIC RAKE WITH HANDLE



MOQ
3

No.	width	no. lamellas	length of handle	
61133	50 cm	22	160 cm	3

PLASTIC RAKE



PLASTIC RAKE WITH HANDLE



MOQ
3

No.	width	no. lamellas	
45321	40 cm	23	20

No.	no. lamellas	length of handle	
61134	23	160 cm	3

PLASTIC RAKE



PLASTIC RAKE WITH HANDLE



MOQ
3

No.	width	no. lamellas	
45054	40 cm	23	10

No.	width	no. lamellas	length of handle	
61135	40 cm	23	160 cm	3

PLASTIC RAKE



PLASTIC RAKE WITH HANDLE



MOQ
3

No.	width	no. lamellas	
45053	58 cm	16	35

No.	width	no. lamellas	length of handle	
61141	58 cm	16	160 cm	3

PLASTIC RAKE WITH ALIGNMENT EDGE



PLASTIC RAKE WITH HANDLE ALIGNMENT EDGE



MOQ
3

No.	width	no. teeth	
45070	41 cm	14	4

No.	width	no. teeth	length of handle	
61142	41 cm	14	160 cm	3

METAL RAKE



No.	width	no. teeth	
61030	24 cm	10	24
61031	29 cm	12	24
61032	34 cm	14	24
61033	40 cm	16	24

METAL RAKE WITH HANDLE



MOQ
3

No.	width	no. teeth	length of handle	
61060	24 cm	10	160 cm	3
61061	29 cm	12	160 cm	3
61062	34 cm	14	160 cm	3
61063	40 cm	16	160 cm	3

RAKE VERTICUTATION METAL



· hammer paint

No.	width	no. teeth	
61045	30 cm	12	25
61046	39 cm	14	25
61047	45 cm	16	25

RAKE WITH WOODEN HANDLE



· hammer paint

MOQ
3

No.	width	no. teeth	length of handle	
61143	30 cm	12	160 cm	3
61144	39 cm	14	160 cm	3
61145	45 cm	16	160 cm	3

RAKE ARETATION



No.	width	no. teeth	
61048	35 cm	11 21	12

RAKE ARETATION WITH HANDLE



MOQ
3

No.	width	no. teeth	length of handle	
61146	35 cm	11 21	160 cm	3



METAL RAKE WITH HANDLE FIBERGLASS



MOQ
3

No.	width	no. teeth	length of handle	
61034	34 cm	14	160 cm	3



SPADES AND SHOVELS

SPADE POINTED SMALL



• suitable for work in the greenhouse

No.	dimensions	length of handle	
61008	19 x 28 cm	85 cm	5

SPADE ROUND



No.	dimensions	length of handle	
61005	20 x 29 cm	120 cm	5

SPADE POINTED



No.	dimensions	length of handle	
61006	19 x 28 cm	120 cm	5

SPADE ROUND, EXTENDED



• for persons higher than 180 cm

No.	dimensions	length of handle	
61157	20 x 29 cm	130 cm	5

SPADE POINTED, EXTENDED



• for persons higher than 180 cm

No.	dimensions	length of handle	
61158	19 x 28 cm	130 cm	5

SHOVEL STANDARD



No.	dimensions	length of handle	
61155	24 x 29 cm	120 cm	5

FORK



No.	dimensions	length of handle	
61156	19 x 28 cm	130 cm	5

FORK



FORK, FIBERGLASS HANDLE



No.	dimensions	length of handle	
61007	18 x 28 cm	130 cm	5

No.	dimensions	length of handle	
61010	18 x 30 cm	95 cm	12

SPADE POINTED, FIBERGLASS HANDLE

SPADE, FIBERGLASS HANDLE



No.	dimensions	length of handle	
61029	19 x 30 cm	95 cm	12

No.	dimensions	length of handle	
61015	19 x 30 cm	95 cm	12

SHOVEL COAL

ALU



No.	dimensions	
61026	26 x 29 cm	10
61025	34 x 30 cm	10

ALU SHOVEL WITH HANDLE

ALU



• beech handle with knuckle



MOQ
3

No.	dimensions	length of handle	
61057	26 x 29 cm	130 cm	3
61056	34 x 30 cm	130 cm	3

SHOVEL COAL



No.	dimensions	
61021	35 x 35 cm	10

SHOVEL COAL WITH HANDLE



MOQ
3

No.	dimensions	length of handle	
61089	35 x 35 cm	130 cm	3

ROUND SHOVEL WITH HANDLE



- hammer paint
- beech handle with knuckle

MOQ
3

No.	dimensions	length of handle	
61050	26 x 28 cm	130 cm	3

ROUND SHOVEL



- hammer paint

No.	dimensions	
61000	26 x 28 cm	12

ROUND SHOVEL WITH HANDLE



- beech handle with knuckle

MOQ
3

No.	dimensions	length of handle	
61088	26 x 28 cm	130 cm	3

ROUND SHOVEL



No.	dimensions	
61020	26 x 28 cm	12

SHOVEL WITH HANDLE



- hammer paint
- beech handle with knuckle

MOQ
3

No.	dimensions	length of handle	
61051	24 x 29 cm	130 cm	3

SHOVEL



- hammer paint

No.	dimensions	
61001	24 x 29 cm	12

SHOVEL WITH HANDLE



- beech handle with knuckle

MOQ
3

No.	dimensions	length of handle	
61090	24 x 29 cm	130 cm	3
61053	24 x 29 cm	130 cm "T _h " handle	3

SHOVEL



No.	dimensions	
61022	24 x 29 cm	12





SHOVEL



No.	dimensions	
61058	25 x 27 cm	12

NARROW SHOVEL



- hammer paint

No.	dimensions	
61002	19 x 27 cm	12

NARROW SHOVEL



No.	dimensions	
61024	19 x 27 cm	12

SPADE POINTED



- hammer paint

No.	dimensions	
61004	22 x 30 cm	12

SHOVEL WITH HANDLE



- beech handle with knuckle

MOQ
3

No.	dimensions	length of handle	
61059	25 x 27 cm	130 cm	3

NARROW SHOVEL WITH HANDLE



- hammer paint
- beech handle with knuckle

MOQ
3

No.	dimensions	length of handle	
61052	19 x 27 cm	130 cm	3

NARROW SHOVEL WITH HANDLE



- beech handle with knuckle

MOQ
3

No.	dimensions	length of handle	
61054	19 x 27 cm	130 cm	3

SPADE POINTED WITH "T" HANDLE



- hammer paint

MOQ
3

No.	dimensions	length of handle	
61161	22 x 30 cm	90 cm	3

SPADE POINTED WITH "T," HANDLE



MOQ
3

No.	dimensions	length of handle	
61097	19 x 30 cm	90 cm	3

SPADE POINTED



No.	dimensions	
61019	22 x 30 cm	12

DROP FORGED SPADE POINTED WITH "T," HANDLE



MOQ
3

No.	dimensions	length of handle	
61162	22 x 25 cm	90 cm	3
61223	handle	90 cm	1

DROP FORGED SPADE POINTED



No.	dimensions	
61013	22 x 25 cm	12

ROUND SPADE WITH "T," HANDLE



MOQ
3

No.	dimensions	length of handle	
61163	21 x 30 cm	90 cm	3

· hammer paint

SPADE ROUND



No.	dimensions	
61003	21 x 30 cm	12

· hammer paint

ROUND SPADE WITH "T," HANDLE



MOQ
3

No.	dimensions	length of handle	
61098	21 x 30 cm	90 cm	3

SPADE ROUND



No.	dimensions	
61018	21 x 30 cm	12





SPADE



No.	dimensions	
61014	14 x 37 cm	12

SPADE WITH "T," HANDLE



No.	dimensions	length of handle	
61164	14 x 37 cm	90 cm	MOQ 3
61203	handle	90 cm	1

FORK



No.	dimensions	
61009	20 x 32 cm	12

FORK WITH HANDLE



· beech handle with knuckle

MOQ 3

No.	dimensions	length of handle	
61165	20 x 32 cm	90 cm	3

DROP FORGED FORK



No.	dimensions	
61012	22 x 30 cm	12

DROP FORGED FORK WITH "T," HANDLE



No.	dimensions	length of handle	
61166	22 x 30 cm	90 cm	MOQ 3
61222	handle	90 cm	1

FORK



No.	dimensions	
61044	20 x 30 cm	12

FORK WITH "T," HANDLE



No.	dimensions	length of handle	
61028	20 x 30 cm	90 cm	MOQ 3
61209	handle	90 cm	1

DROP FORGET HOE WITH HANDLE



No.	dimensions	length of handle	MOQ	
61111	0,4 kg	120 cm	3	
61112	0,6 kg	120 cm	3	
61224	handle	120 cm	1	

DROP FORGET HOE WITH HANDLE



No.	dimensions	length of handle	MOQ	
61114	0,6 kg	120 cm	3	
61224	handle	120 cm	1	

PICKAXE WITH HANDLE



No.	dimensions	length of handle	MOQ	
61121	1,5 kg	95 cm	3	
61042	2,5 kg	95 cm	1	

MOQ
3

DROP FORGET HOE

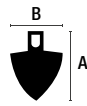

No.	dimensions	A	B	MOQ	
61035	0,4 kg	180 mm	125 mm	1	
61036	0,6 kg	230 mm	160 mm	30	

DROP FORGET HOE

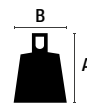

No.	dimensions	A	B	MOQ	
61038	0,6 kg	165 mm	135 mm	20	

PICKAXE



No.	dimensions	MOQ	
61120	1,5 kg	6	
61040	2,5 kg	6	



HOE



No.	dimensions	
61067	75 mm	1
61068	125 mm	1
61069	175 mm	1

HOE WITH HANDLE



MOQ
3

No.	dimensions	length of handle	
61290	75 mm	120 cm	3
61291	125 mm	120 cm	3
61292	175 mm	120 cm	3

HOE



No.	dimensions	
61070	140 mm	40

HOE WITH HANDLE



MOQ
3

No.	dimensions	length of handle	
61293	140 mm	120 cm	3

HOE WITH HANDLE



No.	dimensions	length of handle	
61294	140 mm	27 cm	MOQ 3
61221	handle	27 cm	1

HOE WITH HANDLE



No.	dimensions	length of handle	
61295	140 mm	27 cm	MOQ 3
61221	handle	27 cm	1

HOE WITH HANDLE



No.	dimensions	length of handle	
61296	175 mm	27 cm	MOQ 3
61221	handle	27 cm	1

HOE WITH HANDLE



No.	dimensions	length of handle	
61297		27 cm	MOQ 3
61221	handle	27 cm	1

STAND FOR SHOVEL AND SPADE



• ilustration photo

No.	dimensions		
61077	stand with shovels, spades		1
61079	stand with pallet		1

HOLDER FOR GARDENING TOOLS



• ilustration photo

No.	dimensions		
51185	45 cm		5

HOLDER FOR GARDENING TOOLS

5x



• rotating rubber rollers

No.	dimensions		
51184			12

SICKLE



No.	specification		
45490	450 mm		1

STEEL BRUSH



No.	dimensions	description	
22135	6 x 19 cm	without handle	8
22137	6 x 19 cm	with handle 140 cm	MOQ 3

NYLON BRUSH



No.	dimensions	description	
22136	6 x 19 cm	without handle	8
22138	6 x 19 cm	with handle 140 cm	MOQ 3

STEEL BRUSH WITH HANDLE



No.	length of handle	
52198	140 cm	1

BRUSH



No.	dimensions	
52119	29 cm	24

BRUSH WITH SHOVEL



No.	dimensions	
52168		26

BRUSH WITH SHOVEL



No.	dimensions	
52173		26

STEEL SHOVEL - THICK



No.	dimensions	
52176	22 x 23 cm	24

STEEL SHOVEL

Zn

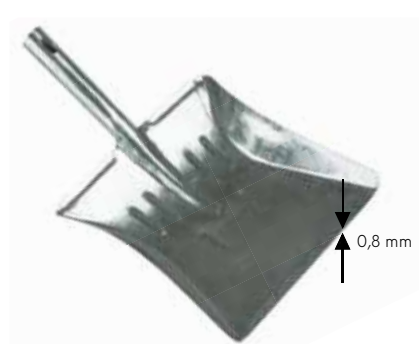

No.	dimensions	
52175	22 x 23 cm	50

BRUSH WITH HANDLE



MOQ
3

No.	dimensions	length of handle	MOQ
52197	30 cm	120 cm wooden	3

BRUSH



No.	dimensions	info	MOQ
52108	30 cm	thread	25
61172	handle 120 cm	thread	1

SET BRUSH, ALU HANDLE



MOQ
3

No.	dimensions	length of handle	MOQ
61149	37 cm	160 cm	3

BRUSH



No.	dimensions	MOQ
45323	37 cm	16

BRUSH WITH HANDLE



MOQ
3

No.	dimensions	length of handle	MOQ
52190	30 cm	150 cm	3
52191	40 cm	150 cm	3
52192	50 cm	150 cm	3
52193	60 cm	150 cm	3
52194	80 cm	150 cm	3

BRUSH

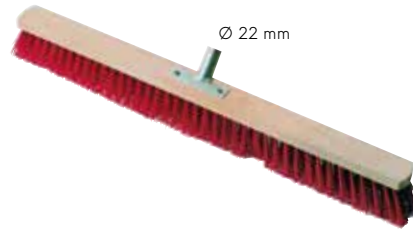

No.	dimensions	MOQ
52101	30 cm	10
52102	40 cm	10
52103	50 cm	10
52104	60 cm	10
52105	80 cm	10

BRUSH WITH HANDLE



MOQ
3

No.	dimensions	length of handle	MOQ
52185	40 cm	150 cm	3
52186	50 cm	150 cm	3
52187	60 cm	150 cm	3
52188	70 cm	150 cm	3
52189	80 cm	150 cm	3

BRUSH



No.	dimensions	MOQ
52160	40 cm	10
52161	50 cm	10
52162	60 cm	10
52163	70 cm	10
52164	80 cm	10





BRUSH



No.	dimensions		
52114	28 cm	thread	1

BRUSH WITH HANDLE



MOQ
3

No.	dimensions	length of handle	
52116	28 cm	with handle 130 cm	3

BRUSH



No.	dimensions	info	
52113	30 cm	thread	26
52115	30 cm	without thread	26

BRUSH WITH HANDLE



MOQ
3

No.	dimensions		
52196	30 cm	130 cm ALU	3
52195	30 cm	150 cm wooden	3

MASON STAFF - RUBBER



No.	specification	
15886	450 mm butt Ø 23 mm	48
15887	600 mm butt Ø 23 mm	48
15888	750 mm butt Ø 23 mm	32

BRUSH WITH HANDLE



No.	dimensions	
52109	25 cm	120 cm wooden 12

SPARE MOP

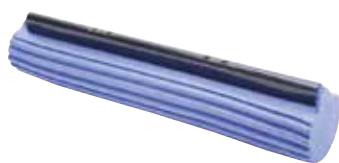

No.	dimensions	
52111	30 cm	1

CLEANING MOP



No.	dimensions	
52110	30 cm	16



SNOW SHOVELS

SNOW SHOVEL



SNOW SHOVEL



No.	dimensions	
60006	46 x 34 cm	12
60206	46 x 34 cm, assembled	1

No.	dimensions	
60008	50 x 34 cm	12
60208	50 x 34 cm, assembled	1

SNOW SHOVEL



SNOW SHOVEL

ALU



No.	dimensions	
60001	48 x 40 cm	10
60201	48 x 40 cm, assembled	1

No.	dimensions	
60012	50 x 38 cm	12
60212	50 x 38 cm, assembled	1

ICE SCRAPER



No.	dimensions
60022	20 cm

MOQ
3

ICE SCRAPER



No.	dimensions	
60018	15 cm	20
60019	0 cm	24
60020	30 cm	20
61201	handle 130 cm	10

ROAD SALT



No.	dimensions
43300	10 kg
43301	25 kg

1
1

BRUSH HANDLE



No.	dimensions	
61172	120 cm wooden handle with thread	1
61192	150 cm wooden handle with thread	pro for 52195 1
61193	150 cm wooden handle with thread	pro for 52185 - 94 1
61194	140 cm wooden handle with thread	1

BRUSH HANDLE

ALU



No.	dimensions
52125	130 cm, fine thread
52126	130 cm, thread

1
1

BRUSH HANDLE



No.	dimensions		No.	dimensions	
61171	1,2 m	1	61175	1,6 m	1
61173	1,4 m	1	61176	1,7 m	1
61174	1,5 m	1	61177	1,8 m	1

HANDLE

ALU

FESTA



system click
ON - OFF

No.	dimensions
45330	161 cm
45331	100 cm

24
24

HANDLE FOR FORK AND SHOVEL



No.	dimensions	
61200	130 cm	10

HANDLE FOR SHOVEL



No.	dimensions	
61201	130 cm, straight	10

HANDLE FOR SHOVEL "T,"



No.	dimensions	
61208	90 cm	10

HANDLE FOR SHOVEL "T,"



No.	dimensions	
61202	130 cm, straight	10

HANDLE FOR MASON DIPPER



No.	dimensions	
61215	160 cm	10

HANDLE FOR SPADE



No.	dimensions	
61207	100 cm	10

HANDLE FOR PICKAXE FIBERGLASS



· for pickaxe 2,5 kg 61040

No.	dimensions	
61206	95 cm	1

HANDLE FOR PICKAXE



No.	dimensions	
61204	95 cm, narrow, (for 61120)	10
61205	95 cm	10

HANDLE FOR PLASTIC RAKE



No.	dimensions	
61195	120 cm	10

HANDLE FOR HOE



No.	dimensions	
61219	120 cm	10

HANDLE FOR RAKE



No.	dimensions	suitable for	
61250	160 cm	45051, 61048	20
61251	160 cm	45052	20
61252	160 cm	45320	20
61253	160 cm	45053	20
61254	160 cm	45054	20
61255	160 cm	45070	20
61256	160 cm	45055	20

HANDLE FOR STEEL RAKE



No.	dimensions	
61183	150 cm	10
61184	160 cm	10
61189	170 cm	10
61190	180 cm	10

PLASTIC HANDLE "Y,"



No.	dimensions	
61230		10

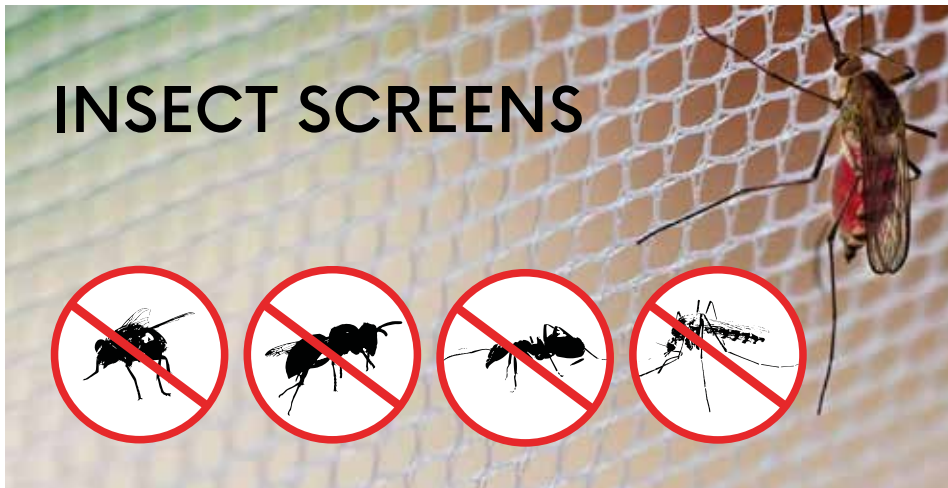

INSECT SCREENS

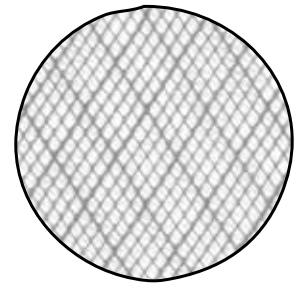

No.	dimensions	
40100	1 x 25 m - PE white	1
40120	1,2 x 25 m - PE white	1

INSECT SCREENS

ALU
Zn

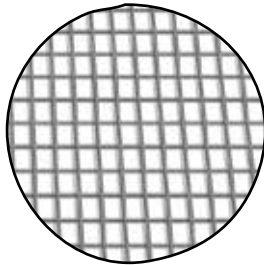

No.	dimensions	
42101	1 x 30 m - ALUMINIUM	2
42103	1 x 30 m - galvanized wire	2

INSECT SCREENS

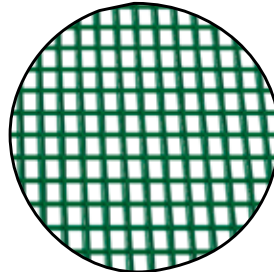

No.	dimensions	
42102	1 x 30 m - green coated steel wire	2

CURTAIN AGAINST INSECT



· variable size 60 - 120 cm

No.	dimensions	
40075	4 x 35 x 220 cm white	20
40076	4 x 35 x 220 cm black	20

FIBERGLASS INSECT SCREENS

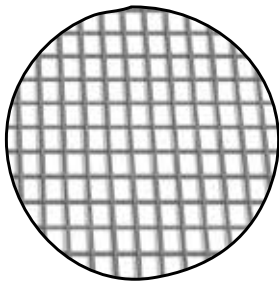

No.	dimensions	
41083	0,8 x 30 m white	6
41103	1 x 30 m white	6
41123	1,2 x 30 m white	6
41153	1,5 x 30 m white	6

No.	dimensions	
41082	0,8 x 30 m white-grey	6
41102	1 x 30 m white-grey	6
41122	1,2 x 30 m white-grey	6
41152	1,5 x 30 m white-grey	6

No.	dimensions	
41050	0,5 x 30 m grey	6
41080	0,8 x 30 m grey	6
41100	1 x 30 m grey	6
41120	1,2 x 30 m grey	6
41150	1,5 x 30 m grey	6

No.	dimensions	
41081	0,8 x 30 m black	6
41101	1 x 30 m black	6
41121	1,2 x 30 m black	6
41151	1,5 x 30 m black	6

WINDOW NET - WHITE



No.	dimensions	
40050	150 x 130 cm 5,6 m	10
40052	150 x 180 cm 6,6 m	10
40054	150 x 90 cm 4,8 m	10
40056	220 x 75 cm 2 pcs 5,8 m	10

WINDOW NET - GREY



No.	dimensions	
40051	150 x 130 cm 5,6 m	10
40053	150 x 180 cm 6,6 m	10
40055	150 x 90 cm 4,8 m	10

WINDOW NET - BLACK



No.	dimensions	
40057	150 x 130 cm 5,6 m	10
40058	150 x 180 cm 6,6 m	10
40059	150 x 90 cm 4,8 m	10

BURBAND SELF ADHEZIVE FOR WINDOW NET



No.	dimensions	
40060	9 mm 7 m	1

FENCING HEX

Zn



· galvanized before entanglement

No.	dimensions	
42150	13 0,7 x 1000 mm - 50 m	1
42151	16 0,7 x 1000 mm - 50 m	1
42152	20 0,7 x 1000 mm - 50 m	1
42153	25 0,8 x 1000 mm - 50 m	1

FENCING HEX

Zn



No.	dimensions	
42155	13 0,7 x 1000 mm - 50 m	1
42156	16 0,7 x 1000 mm - 50 m	1
42157	20 0,7 x 1000 mm - 50 m	1
42158	25 0,8 x 1000 mm - 50 m	1

FENCING HEX PVC COATED

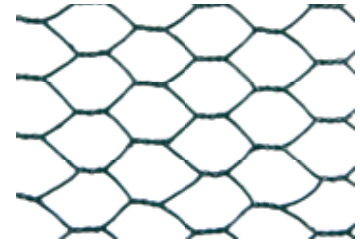

No.	dimensions	
42160	13 1 x 1000 mm - 25 m	1
42161	16 1 x 1000 mm - 25 m	1
42162	20 1 x 1000 mm - 25 m	1
42163	25 1 x 1000 mm - 25 m	1

FENCING RECTANGULAR

Zn

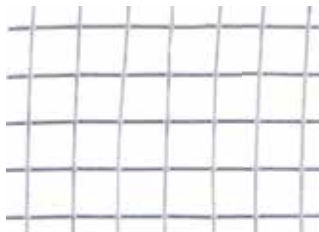

No.	dimensions		No.	dimensions	
42185	6 0,65 x 1000 mm - 25 m	1	42174	25 1,4 x 1000 mm - 25 m	1
42170	10 0,8 x 1000 mm - 25 m	1	42186	13 1,05 x 1000 mm - 25 m	1
42171	13 0,8 x 1000 mm - 25 m	1	42187	25 2,0 x 1000 mm - 25 m	1
42172	16 1,2 x 1000 mm - 25 m	1	42188	50 2,0 x 1000 mm - 25 m	1
42173	19 1,4 x 1000 mm - 25 m	1			

FENCING RECTANGULAR PVC COATED

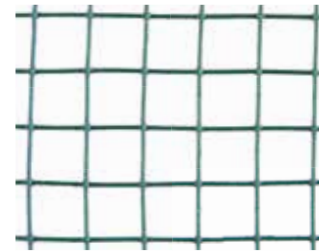

No.	dimensions	
42180	13 1,2 x 1000 mm - 25 m	1
42181	16 1,2 x 1000 mm - 25 m	1
42182	25 2,3 x 1000 mm - 25 m	1

SAFETY MESH FENCING

140 g/m²
UV STABLE

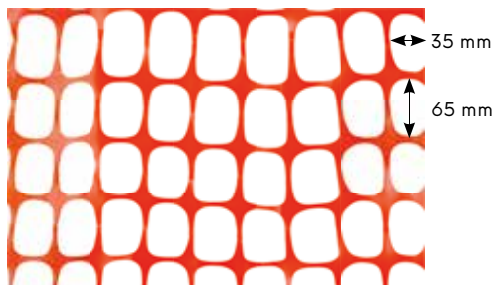

No.	dimensions		
42190	1,2 x 50 m	HDPE 140g/m ²	1

GARDEN FENC PVC COATED



No.	eye size	Ø of wire	height	length	
42175	15 x 9 mm	2 mm	40 cm	25 m	1
42176	15 x 9 mm	2 mm	65 cm	25 m	1
42177	15 x 9 mm	2 mm	90 cm	25 m	1
42178	15 x 9 mm	2 mm	120 cm	25 m	1
42179	15 x 9 mm	2 mm	25 cm	25 m	1

FENCING RABIC

Zn



No.	dimensions	
42312	1 m 50 bm, 16 x 16 mm	1

NET AGAINST BIRDS



No.	dimensions	
45570	2 x 5 m 18 x 18 mm	45
45571	2 x 10 m 18 x 18 mm	28
45572	4 x 5 m 18 x 18 mm	24
45573	4 x 10 m 18 x 18 mm	15



FENCING AGAINST BROWSING



3x

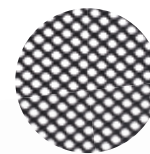

No.	dimensions	
45580	Ø 11 x 80 cm	1

· self-locking

WIRE

Zn



No.	Ø of wire	length of wire	
42203	0,6 mm	30 m	50

WIRE

Zn



No.	Ø of wire	length of wire	
42207	0,8 mm	50 m	40
42208	0,8 mm	100 m	20
42209	0,9 mm	100 m	20
42240	1,0 mm	50 m	40
42210	1,0 mm	100 m	20
42211	1,2 mm	50 m	40
42212	1,2 mm	100 m	20
42213	1,4 mm	30 m	40
42214	1,4 mm	50 m	20
42217	1,8 mm	30 m	40
42218	1,8 mm	50 m	20

WIRE

Zn



No.	Ø of wire	length of wire	
42219	2,0 mm	26 m	20
42220	2,0 mm	52 m	20
42221	2,0 mm	78 m	20
42228	3,15 mm	26 m	10
42229	3,15 mm	52 m	10
42230	3,15 mm	78 m	10

WIRE



No.	Ø of wire	length of wire	coating	
42201	0,6 mm	30 m	PVC	50
42202	0,9 mm	30 m	PVC	50

WIRE, GREEN PVC COATED



No.	Ø of wire	length of wire	
42244	1,4 mm	50 m	20
42248	1,8 mm	50 m	20
42249	2,0 mm	50 m	20

WIRE, GREEN PVC COATED



No.	Ø of wire	length of wire	
42251	2,6 mm	26 m	20
42252	2,6 mm	52 m	20
42253	2,6 mm	78 m	20
42255	3,4 mm	26 m	10
42256	3,4 mm	52 m	10
42257	3,4 mm	78 m	10

BARBED WIRE

Zn



No.	Ø of wire	length of wire	
42260	1,7 mm	50 m	1
42261	1,7 mm	100 m	1

CLAMP OF THE BINDING WIRE

INOX



No.	info	
50040	stainless edge, green	50
50041	stainless edge, black	50

CLAMP OF THE BINDING WIRE

10x



No.	info	
50042		10

WIRE STRAINER SMALL

Zn



No.	info	
50030	small, ZN coated	50
50032	small PVC coated	50

WIRE STRAINER BIG

Zn



No.	info	
50031	ZN coated	50
50033	PVC coated	50

WIRE STRAINER SMALL LT

Zn



No.	info	
50037	Zn coated	50
50038	PVC coated	50

TIGHTENING EQUIPMENT



No.	info	
50035	2 t	6
50036	4 t	4

SOIL DRILL



No.	∅	A	B	
61299	110 mm	270 mm	1200 mm	1
61300	140 mm	270 mm	1200 mm	1
61301	170 mm	270 mm	1200 mm	1
61302	200 mm	270 mm	1200 mm	1

UNIVERSAL ANCHORAGE - SCREW SET

Zn

6x

reduction

- ∅ 24 mm
- ∅ 35 mm
- ∅ 40 mm
- ∅ 48 mm
- ∅ 55 mm



No.	∅ anchor	length of anchor	info	
55450	60 mm	550 mm	1 pcs + 5x reduction	8

POLE ANCHORE

Zn



No.	∅ anchor	length of anchor	material thickness	
55400	71 x 71 mm	750 mm	2 mm	1
55401	91 x 91 mm	750 mm	2 mm	1
55406	81 x 81 mm	750 mm	2 mm	1
55402	91 x 91 mm	900 mm	2 mm	1
55403	101 x 101 mm	900 mm	2 mm	1
55404	121 x 121 mm	900 mm	2 mm	1
55405	151 x 151 mm	900 mm	2 mm	1

POLE ANCHORE

Zn



No.	∅ anchor	length of anchor	material thickness	
55420	71 x 71 mm	150 mm	2 mm	1
55425	81 x 81 mm	150 mm	2 mm	1
55421	91 x 91 mm	150 mm	2 mm	1
55422	101 x 101 mm	150 mm	2 mm	1
55423	121 x 121 mm	150 mm	2 mm	1
55424	151 x 151 mm	150 mm	2 mm	1

POLE ANCHORE

Zn



No.	dimensions	thickness		∅ 18 x 200mm
55436	70 x 75 mm	110 mm	4 mm	10
55437	80 x 90 mm	130 mm	4 mm	10

POLE ANCHORE

Zn



No.	dimensions	thickness		∅ 18 x 200mm
55429	70 x 60 mm	100 mm	4 mm	10
55433	81 x 60 mm	100 mm	4 mm	10
55430	91 x 60 mm	100 mm	4 mm	10
55431	101 x 60 mm	100 mm	4 mm	10
55432	121 x 60 mm	100 mm	4 mm	10

ANCHORAGE SCREW "U,"

Zn

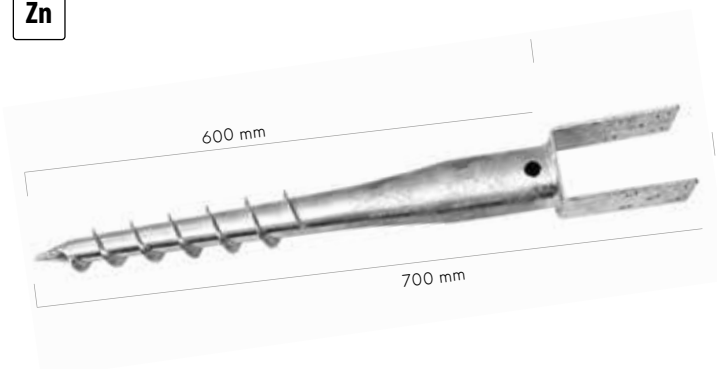

No.	∅ anchor	length of anchor	material thickness	
55455	71 x 60 mm	100 mm	4 mm	1
55452	81 x 60 mm	100 mm	4 mm	1
55456	90 x 60 mm	100 mm	4 mm	1
55453	101 x 60 mm	100 mm	4 mm	1
55457	110 x 60 mm	100 mm	4 mm	1
55454	121 x 60 mm	100 mm	4 mm	1

POLE ANCHORE WITH ADJUSTABLE SCREW

Zn



No.	∅ anchor	hight of anchor	screw	
55460	80 x 80 mm	150 mm	M16	10
55461	100 x 100 mm	150 mm	M16	10
55462	150 x 150 mm	150 mm	M24	10

BAMBOO FENCING AND SHADING NETS



SHADING NET 150 G/ M² ANTHRACITE



150 g/m²

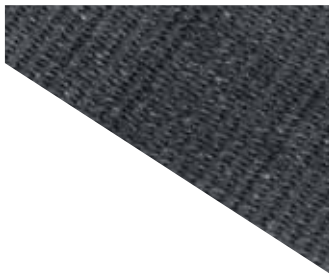

• shade 85%

No.	dimensions	
45496	1 x 10 m	1
45497	1,5 x 10 m	1
45498	1,8 x 10 m	1
45499	2 x 10 m	1

SHADING NET 150 G/ M²



150 g/m²

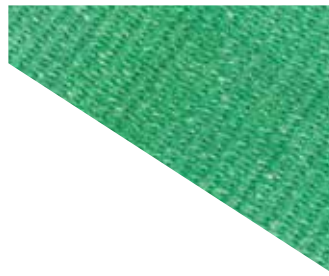

• shade 85%

No.	dimensions	
45460	1 x 10 m	1
45461	1,5 x 10 m	1
45463	1,8 x 10 m	1
45462	2 x 10 m	1

SHADING NET 220 G/ M²



220 g/m²

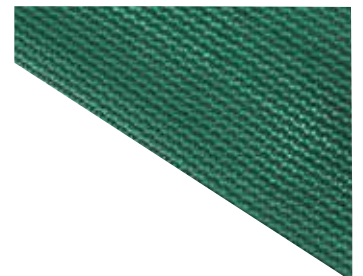

• shade 95%

No.	dimensions	
45465	1 x 10 m	1
45466	1,5 x 10 m	1
45467	2 x 10 m	1

SHADING NET 80 G/ M²



80 g/m²

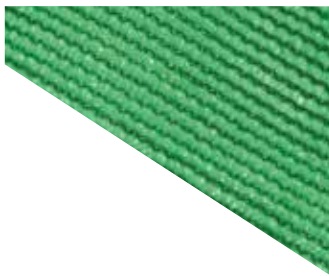

No.	dimensions	
45450	1 x 10 m	1
45451	1,5 x 10 m	1
45453	1,8 x 10 m	1
45452	2 x 10 m	1

SHADING NET 150 G/ M²



150 g/m²

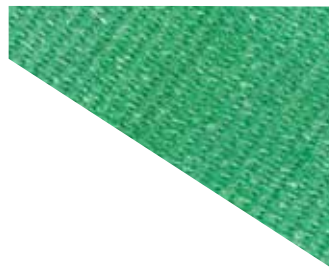

• shade 85%

No.	dimensions	
45480	1,5 x 50 m	1

SHADING NET 220 G/ M²



220 g/m²



• shade 95%

No.	dimensions	
45485	1,5 x 50 m	1

SPLITED BAMBOO



No.	dimensions	
45410	1 x 5 m	1
45415	1,5 x 5 m	1
45420	2 x 5 m	1

REEDCANE



No.	dimensions	
45425	1 x 5 m	5
45426	1,5 x 5 m	5
45427	2 x 5 m	5

HOLDS FOR SHADE CLOTH

20x



No.	dimensions	
45470		1



GRILL

TOOL SET

INOX

18x



No. dimensions

43077



6

TOOL SET

INOX

3x



GRILL PLIERS

INOX



GRILL PLATE

4x



16



25

No. dimensions
43071 380 mm

No. dimensions
43072 360 mm

No. dimensions
43050 300 x 200 mm

50

GRILL

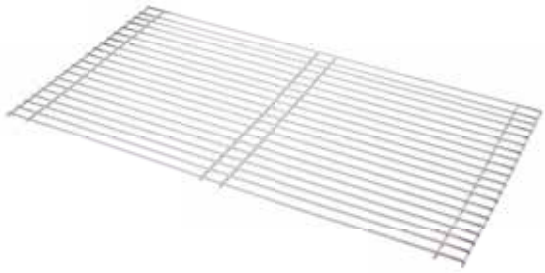

No.	dimensions	
43058	58 x 30 mm	20
43060	60 x 40 mm	20
43068	68 x 40 mm	16

GRILL GRID

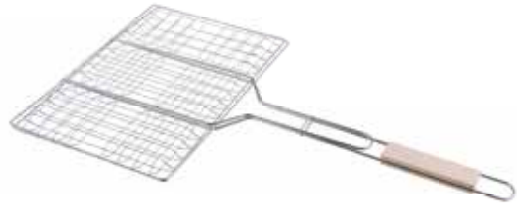

No.	dimensions	
43084	330 x 290 mm	50

FISH FIREGRATE



No.	dimensions	
43082	280 x 276 mm	50

FISH FIREGRATE



No.	dimensions	
43083	360 x 130 mm	12

SKEWERS

4x



No.	dimensions	
43086	∅ 3 x 380 mm	80

GRILL FORK



· grill fork with hygienic atest

No.	dimensions	
43097	100 cm	100

GRILL MOTOR 230V



No. dimensions
43090



24

GRILL MOTOR, BATTERY



No. dimensions
43089



48

BARBEQUE BRUSH 2 IN 1



No. dimensions
43098 30 cm



10

BRUSH 3 IN 1



No. dimensions
43099



40

AIR COMPRESSOR



No. dimensions
43087



1

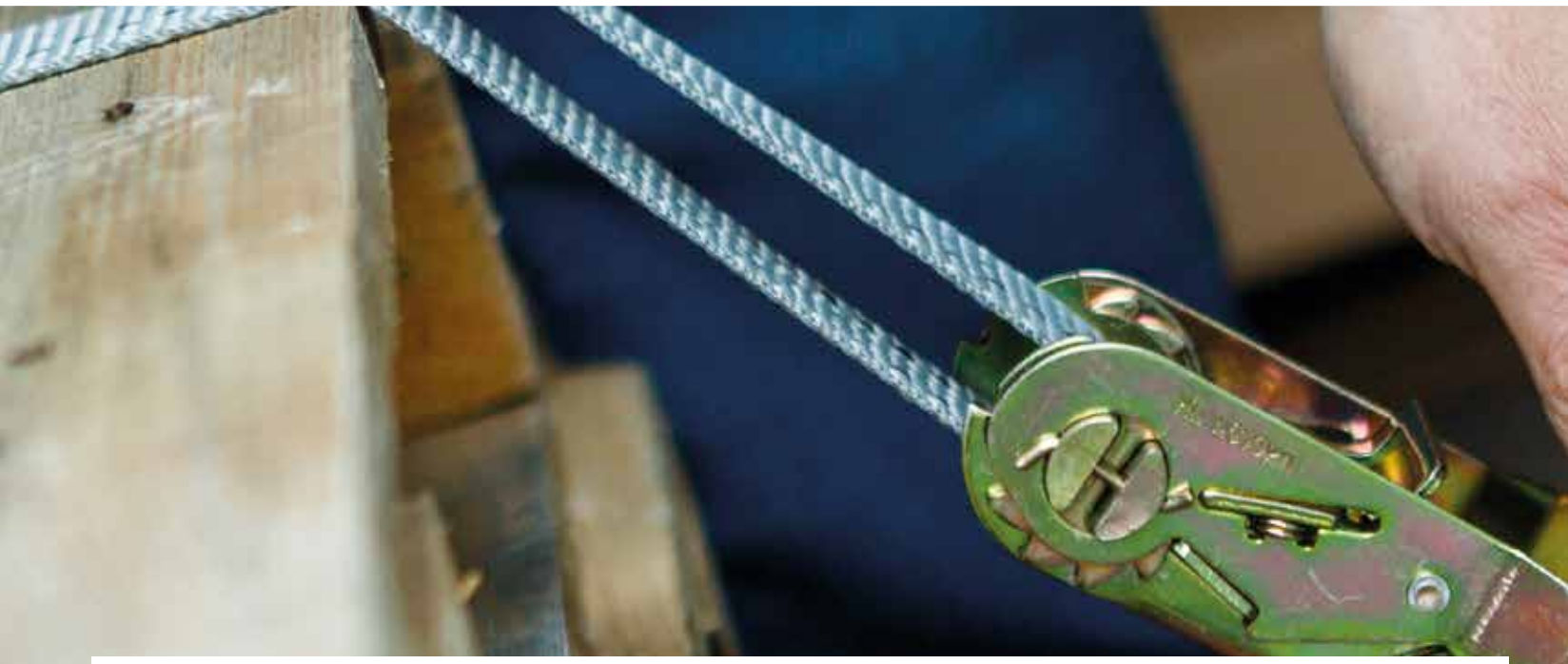

360

LOCK, PADLOCK, BICYCLE LOCK



364

MONEY BOX AND MAILBOX



366

TIE-DOWN STRAP



369

ROPE, TWINE AND BINDING TAPES



371

HOT MELT GLUE GUN



373

HOLDER FOR GLASS PLATE





375

DRAIN CLEANER



377

OTHER GOODS



378

LIGHTS



381

PAPER STAND



382

RACKING SYSTEM SU-5



386

KUBALA TOOLS

HARDWARE TOOLS

358 - 391



LOCKS



SECURITY ELECTRONIC LOCK BOX



NEW

4x AA



- Lock type: electronic, mechanical
- Security key
- Dimensions 350x250x250mm
- Weight 10kg

No. specification

23270



1

BRASS CYLINDER LOCK



BRASS COATED LOCK

3x

3x



No. specification

23001 65 mm · 175 g



12

No. specification

23000 65 mm · 75 g



12

PADLOCK POWER



No.	specification		No.	specification	
23261	25 mm	12	23264	45 mm	12
23262	32 mm	12	23265	52 mm	12
23263	38 mm	12	23266	63 mm	12

PADLOCK POWER EXTENDED



No.	specification		No.	specification	
23211	25 mm	12	23214	45 mm	12
23212	32 mm	12	23215	52 mm	6
23213	38 mm	12			

PADLOCK BRASS, PVC COATED



No.	specification	
23310	30 mm	10
23311	40 mm	10
23312	50 mm	6

PADLOCK POWER



No.	specification		No.	specification	
23125	25 mm	12	23140	40 mm	12
23130	30 mm	12	23150	50 mm	12
23135	35 mm	12	23160	60 mm	12

PADLOCK POWER



No.	specification	
23273	50 mm	10
23274	60 mm	10
23275	70 mm	10

PADLOCK POWER



No.	specification		No.	specification	
23220	25 mm	12	23240	40 mm	12
23225	30 mm	12	23250	50 mm	12
23232	32 mm	12	23260	60 mm	12

PADLOCK BRASS COATED



PADLOCK BRASS COATED EXTENDED



No.	specification		No.	specification	
23020	20 mm	12	23040	40 mm	12
23025	25 mm	12	23050	50 mm	12
23030	30 mm	12	23060	60 mm	12
23035	35 mm	12			

No.	specification	
23070	40 mm	12

PADLOCK POWER



No.	specification	
23010	50 mm	6

PADLOCK POWER



No.	specification	
23005	40 mm	12
23006	50 mm	12

BICYCLE LOCK WITH NUMBER CODE



BICYCLE LOCK WITH NUMBER CODE



No.	specification	
23288	120 cm x Ø 10 mm	1



No.	specification	
23287	65 cm x Ø 10 mm	1

BICYCLE LOCK



No.	specification	
23290	120 cm x Ø 8 mm	20
23291	150 cm x Ø 8 mm	20
23292	180 cm x Ø 8 mm	20

BICYCLE LOCK



No.	specification	
23296	150 cm x Ø 8 mm	25
23297	180 cm x Ø 8 mm	25

BICYCLE LOCK



No.	specification	
23282	55 cm x Ø 8 mm	50
23284	65 cm x Ø 8 mm	50

LOCKING TOLLGATE



No.	
51500	1

LOCK WITH NUMBER CODE



TAGS FOR KEY

100x



strong circle

No.	specification	
23281		20

No.	specification	
23391		50

TAGS FOR KEY

100x



No.	specification	
23390		1

LATCH



No.	specification	
51514	100 mm	25
51515	120 mm	25
51516	140 mm	25
51517	160 mm	25

PLUG



No.	specification	
51510	100 mm	12
51511	120 mm	12
51512	140 mm	12
51513	160 mm	12



CASH BOXES AND MAILBOXES

BOX FOR KEYS



No.	specification	
70140	250 x 180 x 80 mm - for 48 keys	12
70141	300 x 230 x 90 mm - for 90 keys	8

CASH BOX



No.	width	deep	hight	
70120	125 mm	95 mm	60 mm	1

CASH BOX



No.	width	deep	hight	
70121	152 mm	118 mm	80 mm	30

CASH BOX



No.	width	deep	hight	
70122	200 mm	160 mm	90 mm	20

CASH BOX



No.	width	deep	hight	
70123	250 mm	180 mm	90 mm	16

CASH BOX



No.	width	deep	hight	
70124	300 mm	240 mm	90 mm	10

CASH BOX



No.	width	deep	hight	
70125	370 mm	280 mm	90 mm	7

MAILBOX PLASTIC



No.	color	width	deep	hight	
70113	white	240 mm	105 mm	345 mm	6

MAILBOX PLASTIC



No.	color	width	deep	hight	
70114	brown	240 mm	105 mm	345 mm	6

MAILBOX



No.	color	width	deep	hight	
70101	white	290 mm	360 mm	105 mm	5
70100	brown	290 mm	360 mm	105 mm	5

MAILBOX



No.	color	width	deep	hight	
70102	white	310 mm	260 mm	90 mm	10
70103	brown	310 mm	260 mm	90 mm	6

MAILBOX



No.	color	width	hight	deep	
70104	white	310 mm	360 mm	90 mm	6
70105	brown	310 mm	360 mm	90 mm	6

MAILBOX



No.	color	width	deep	hight	
70108	white	370 mm	134 mm	364 mm	5

MAILBOX



INOX



No.	material	width	deep	hight	
70107	stainless	360 mm	100 mm	520 mm	6

MAILBOX



INOX



No.	material	width	deep	hight	
70106	stainless	360 mm	100 mm	360 mm	5

MAILBOX



INOX



No.	material	width	deep	hight	
70109	stainless	310 mm	90 mm	260 mm	6

MAILBOX



INOX



No.	material	width	deep	hight	
70110	stainless	310 mm	90 mm	360 mm	6

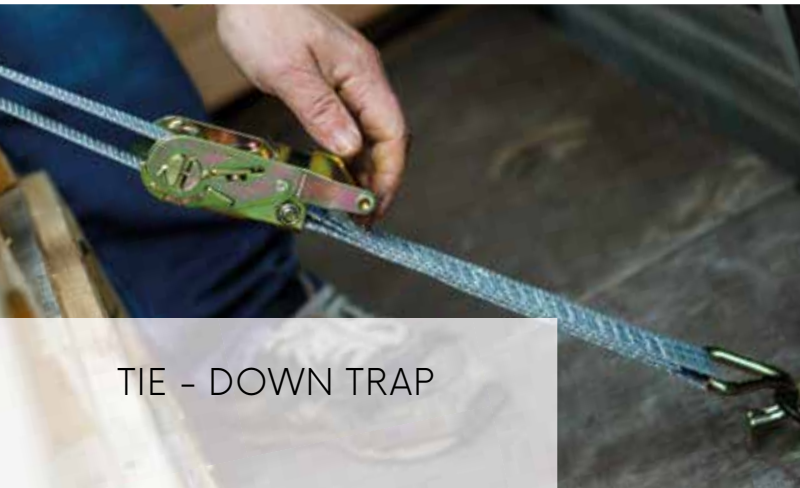

TIE - DOWN TRAP

TIE - DOWN STRAP, SELF-WINDING



2x



No.	width	length	load capacity	pcs	
51070	18 mm	2 m	100 kg	2	8

TIE - DOWN STRAP, SELF-WINDING



No.	width	length	load capacity	pcs	
51071	25 mm	3,5 m	300 kg	1	12

TIE - DOWN STRAP, SELF-WINDING



No.	width	length	load capacity	pcs	
51072	35 mm	4 m	500 kg	1	6

TIE - DOWN STRAP



No.	width	length	load capacity	pcs	
51040	25 mm	6 m	1000 kg	1	1
51041	35 mm	8 m	2000 kg	1	1
51042	35 mm	8 m	3000 kg	1	1
51043	50 mm	10 m	5000 kg	1	1

TIE - DOWN STRAP



2x



No.	width	length	load capacity	pcs	
51060	25 mm	5 m	750 kg	2	5

TIE - DOWN STRAP



No.	width	length	load capacity	pcs	
51065	50 mm	10 m	960 kg	1	6

TIE - DOWN STRAP



No.	width	length	load capacity	pcs	
51026	75 mm	5 m	3000 kg	1	4

TIE - DOWN STRAP



No.	width	length	load	pcs	
51017	50 mm	6 m	480 kg	2	5
51018	50 mm	6 m	480 kg	1	10

TIE - DOWN STRAP



No.	width	length	specification	pcs	
51022	25 mm	5 m	with hooks	40	
51023	50 mm	5 m	with hooks	12	

TIE - DOWN STRAP



PE



softened EVA pad

No.	width	length	pcs	
51046	38 mm	4 m	1	30

TIE - DOWN STRAP



No.	width	length	specification	pcs	
51030	50 mm	6 m	with hooks	20	
51034	50 mm	8 m	with hooks	10	

TIE - DOWN STRAP

2x



No.	width	length	pcs	
51020	25 mm	2,5 m	2	100

TIE - DOWN STRAP

PE



No.	width	length	pcs	
51045	25 mm	4 m	1	50

RUBBER STRAP WITH HOOKS

2x



No.	length	Ø	pcs	
51013	1,2 m	8 mm	2	30

RUBBER STRAP WITH HOOKS

2x



No.	length	pcs	
51008	1 m	2	25

RUBBER STRAP WITH HOOKS



No.	length	Ø	pcs	
51009	1 m	10 mm	1	50

SET OF RUBBER STRAP WITH HOOKS

8x

- 2 x 0,4 m
- 2 x 0,6 m
- 1 x 0,8 m
- 1 x 1,0 m



No.	length	Ø	pcs	
51011	1 m	8 mm	8	10

RUBBER STRAP WITH HOOKS

2x



No.	length	Ø	pcs	
51001	80 cm	10 mm	2	50
51002	100 cm	10 mm	2	50
51003	150 cm	10 mm	2	50
51004	200 cm	10 mm	2	50

RUBBER STRAP WITH HOOKS

2x



No.	length	Ø	pcs	
51007	1 m	8 mm	2	25

RUBBER ROPE - SPIDER



No.	length	Ø	specification	
51010	80 cm	8 mm	8 shoulders	50

RUBBER NET WITH HOOKS



No.	length	width	
51015	80 cm	120 cm	20

RUBBER STRAP



No.	length	Ø	
51036	20 m	8 mm	10
51037	20 m	10 mm	6

HOOKS FOR RUBBER STRAPS

20x



No.	length	
51038	8 mm	30

ALUMINIUM HOOK

ALU



MOQ
2

No.	∅	length		No.	∅	length	
51186	4 mm	40 mm	2	51202	7 mm	70 mm	2
51187	5 mm	50 mm	2	51201	8 mm	80 mm	2
51200	6 mm	60 mm	2	51203	10 mm	100 mm	2

NYLON ROPE



No.	length	∅	
51055	80 m	1,5 mm	50
51056	50 m	2 mm	50
51057	20 m	4 mm	50

PP TWINE



No.	weight	
50905	80 g	80
50906	100 g	100
50907	200 g	50

JUTE TWINE



No.	weight	
50900	80 g (61 m)	1
50901	100 g (76 m)	1
50902	200 g (153 m)	1

ROPE



No.	length	∅	
50915	5 m	8 mm	1
50916	25 m	8 mm	1
50917	25 m	10 mm	1
50918	25 m	12 mm	1
50919	25 m	14 mm	1

NYLON ROPE



No.	length	∅	
51050	50 m	8 mm	10
51051	50 m	10 mm	4

PP TWINE



No.	weight	
50909	500 g (250 m)	1
50910	1000 g (500 m)	1
50911	5000 g (2500 m)	1

WAXED TWINE



No.	length	∅	
50920	50 m	1 mm	80

BINDING TAPES

10x



Ø 15 - 32 mm



No.	length	width
23865	160 mm	7,5 mm

1

BINDING TAPES BLACK

50x



EN 50146
nylon

No.	length	width
23810	120 mm	2,5 mm
23814	200 mm	3,6 mm
23816	250 mm	3,6 mm
23818	250 mm	4,8 mm
23820	300 mm	4,8 mm
23824	400 mm	4,8 mm
23826	500 mm	4,8 mm
23828	400 mm	7,6 mm
23830	500 mm	7,6 mm

1

BINDING TAPES

100x



EN 50146
nylon

No.	length	width
23880	100 mm	2,5 mm
23882	150 mm	2,5 mm
23884	200 mm	3,6 mm

1

1

1

BINDING TAPES WHITE

50x



EN 50146
nylon

No.	length	width
23850	120 mm	2,5 mm
23854	200 mm	3,6 mm
23856	250 mm	3,6 mm
23858	250 mm	4,8 mm
23860	300 mm	4,8 mm
23864	400 mm	4,8 mm
23866	500 mm	4,8 mm
23868	400 mm	7,6 mm
23870	500 mm	7,6 mm

1

1

1

1

1

1

1

1

1

BINDING TAPE, VELCRO



No.	specification
45471	12 mm x 5 m

1

VELCRO TAPE 3 PCS



3x



No.	wideness	length
37295	20 mm	150 mm
37296	20 mm	200 mm
37297	20 mm	250 mm

1

1

1

HOT MELT GLUE GUN - WIRELESS



No.	specification
89975	80 W 230 V Ø glue stick 11,2 mm

20

HOT MELT GLUE GUN



No.	specification
89973	60 W 230 V Ø glue stick Ø 11,2 mm

20

HOT MELT GLUE GUN



No.	specification
89970	15 W 230 V Ø glue stick 7,2 mm

20

HOT MELT GLUE STICK - TRANSPARENT



No.	Ø glue stick	length	pcs	
89985	11,2 mm	200 mm	10	50
89987	11,2 mm	200 mm	1 kg	25



25

HOT MELT GLUE STICK - TRANSPARENT



No.	Ø glue stick	length	pcs	
89980	7,2 mm	100 mm	12	100
89988	7,2 mm	100 mm	1 kg	25



25

HOT MELT GLUE STICK - MULTICOLOUR



No.	Ø glue stick	length	pcs	
89990	11,2 mm	200 mm	10	50



50

HOT MELT GLUE STICK - MULTICOLOUR



No.	Ø glue stick	length	pcs	
89989	7,2 mm	100 mm	12	100



100

HEATING GUN



voltage	230V / 50Hz
power consumption	2000W
position of switch	0 - I (350°C) - II (600°C)
accessories	stainless extensions - 4 pcs

No.	specification
35320	2000 W



HEATING GUN WITH REGULATION OF TEMPERATURE AND AIR FLOW



- digital display



voltage	230V / 50Hz
power consumption	2000W
position of switch	0 - I (50°C) - II (50 - 600°C)
air flow	250 - 500 l/min.
accessories	stainless extensions - 4 pcs

No.	specification
35322	2000 W



EXTENSION CABLE WITH REEL



- Extension cable with 25 m reel - IP20
- H05VV - F 3G 1.5mm², - Equipped with a thermal fuse
- Welding power: 1000 W max.
- Output power: 3000 W max.
- 4 grounded sockets with child lock.



No.	specification	
37760	4 socket, length 25 m, IP 20, 1,5 mm ²	1
37761	4 socket, length 50 m, IP 20, 1,5 mm ²	1

EXTENSION CABLE



No.	specification	
37730	max. 3680 W length 10 m, 1,5 mm ²	8
37731	max. 3680 W length 20 m, 1,5 mm ²	4

HOLDER FOR GLASS PLATE



ALU



position	max. load
horizontal position	50 kg
vertical position	50 kg
No.	specification
36314	single



20

HOLDER FOR GLASS PLATE



No.	specification
36305	single



60

HOLDER FOR GLASS PLATE



ALU



position	max. load
horizontal position	80 kg
vertical position	100 kg
No.	specification
36313	double



20

HOLDER FOR GLASS PLATE



No.	specification
36306	double



20

HOLDER FOR GLASS PLATE



NEW

ALU



position	max. load
horizontal position	120 kg
vertical position	150 kg



10

HOLDER FOR GLASS PLATE

NEW



position	max. load
horizontal position	80 kg
vertical position	100 kg



10

STEELYARD ANALOG



No.	max.
24260	50 kg



STEELYARD



No.	max.	
24212	12,5 kg	48
24225	25 kg	6
24250	50 kg	6
24255	100 kg	6
24258	150 kg	6

TWEEZERS WITH LED LIGHT



No.	specification
50005	95 mm



TWEEZER SET STAINLESS

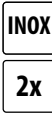

No.	specification
50004	



MOUSETRAP

2x



No.	specification
70221	90 x 45 mm wooden



MOUSETRAP

2x



No.	specification
70220	97 x 47 mm plastic



CLEANING MOP



No.	specification
52110	30 cm



SPARE MOP

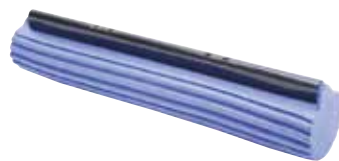

No.	specification
52111	30 cm



DRAIN CLEANER



· can be used with drilling-machine

No.	length	Ø
50014	6 m	6 mm



6

DRAIN CLEANER



No.	length	Ø
50009	3 m	5 mm



40

DRAIN CLEANER



No.	length
50010	3 m
50011	5 m
50012	10 m
50013	15 m



20

10

6

4

SUCTION PUMP



No.	length	Ø
50015	385 mm	65 mm



36

DRAW TAPE



No.	length	Ø
51181	8 m	5 mm
51182	10 m	5 mm



25

25

PICK UP TOOL FOR GARBAGE

GARBAGE PLIERS



· rotary 90°

No.	length
61235	81 cm



· max. 4 kg

No.	specification
61236	



TELESCOPIC POLE

ALU



No.	length	ALU	
52010	120 cm	ALU	50
52012	240 cm	ALU	25

TELESCOPIC POLE



No.	length	steel	
52020	300 cm	steel	10

TELESCOPIC POLE



No.	length	fiberglass	
52030	240 cm	fiberglass	6

OILING CAN



No.	specification	
50020	300 ml	10

GREASE GUN

- bulk loading
- cartridge loading
- loading with dispenser

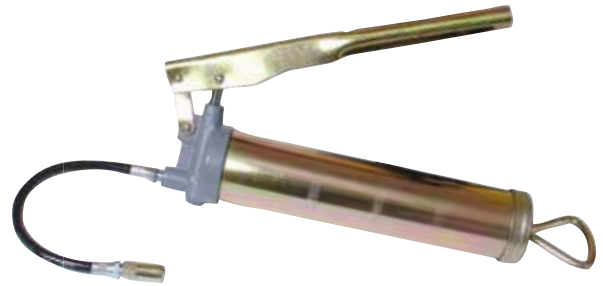

No.	specification	
50022	400 ml	20

CANISTER PUMP



No.	specification	
50017		10

OILING CAN



No.	specification	
50019	90 ml	1

BELT WRENCH

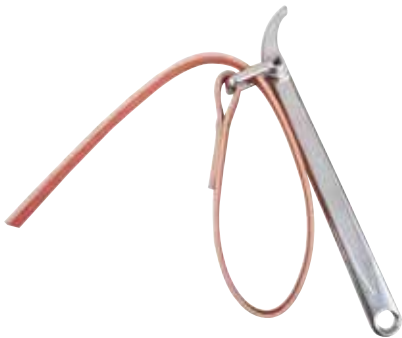

No.	specification	
50021	60 x 140 mm	6

FLEXIBLE FUNNEL



No.	specification	
50025	60 x 140 mm	50

HOSE WITH SELF-PRIMING VALVE



No.	length	∅	
50026	180 cm	15 mm	24

LAMPS AND LIGHTS

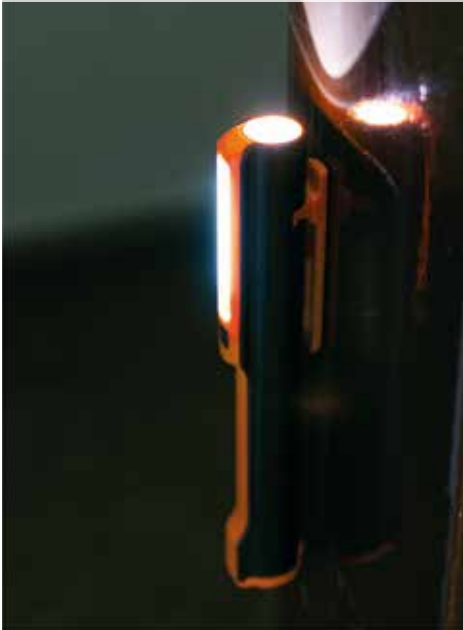

LED LIGHT

- LED light
-
- 3x AAA



· magnets for sticking to a steel door frame and so.



MOQ
12

No.	specification
37645	200 mm 3 x AAA



LED HEAD LAMP

- LED light
- 3x AAA
- 120 lumen

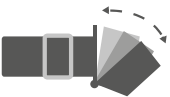

· 5 positions

Weight	42 g
Light source	1 x 1 W white LED + 2x red LED
Battery:	3 x AAA
Dimensions	40 x 59 x 32 mm
Time of lighting	45 h
Aperture	120 lumen
Light distance	60 m (100% battery)
Type of lighting	4

No.	light
37641	2 kinds of light, white and red



LED HEADLAMP

- LED light
- 3x AAA
- 120 lumen



No.	light
37640	120 lumen + red light



LED LAMP

FESTA

LED light

3x AA



220 lumen

soft PVC coating



130 lumen

adjustable handle



handle with hooks



No.

37650



12

LED LIGHT

FESTA

ALU

LED light

2x AA

80 lumen



No.

specification

37630

185 mm

2 x AA



20

LED LIGHT

LED light



ord.n	37621
output:	0,6 W
color temperature:	700k
battery:	2xD
weight:	138g
length of light:	30 m
aperture:	50 lm

No.

specification

37621

185 mm



6

BRACKET WHITE



MOQ
2

No.	specification	
81100	100 x 75 mm	24
81101	125 x 100 mm	24
81102	150 x 125 mm	24
81103	200 x 150 mm	24
81104	250 x 200 mm	24
81105	300 x 250 mm	24
81106	350 x 300 mm	24



BRACKET BROWN



MOQ
2

No.	specification	
81113	200 x 150 mm	24
81114	250 x 200 mm	24
81115	300 x 250 mm	24



HOOK BRACKET SINGLE



No.	specification	
81053	50 cm	10
81054	80 cm	10
81055	100 cm	10
81056	150 cm	10
81057	200 cm	10



HOOK BRACKET SINGLE



No.	specification	
81070	10 cm	10
81071	15 cm	10
81072	20 cm	10
81073	25 cm	10
81074	30 cm	10
81075	35 cm	10
81076	40 cm	10
81077	50 cm	10



PAPER STAND FESTA



No. specification
81602 60 x 40 x 175 cm - ENG



1

PAPER STAND FESTA POWER TOOLS



No. specification
81603 60 x 40 x 175 cm



1

PAPER STAND FOR LEVELING SYSTEMS



No. specification
37179 60 x 40 x 175 cm - ENG



1

RACKING SYSTEM SU - 5



WE CAN ALSO ARRANGE YOU REQUIRED SHELF ASSEMBLY



FESTA STAND + ACCESORIES



No.	specification	
81011	stand FESTA 220 x 100 cm	1
81011A	stand 81011 + sticker AQUATIC	1
81011F	stand 81011 + sticker FESTA CZ	1
81011G	stand 81011 + sticker FESTA GB	1
81011H	stand 81011 + sticker FESTA SK	1
81011R	stand 81011 + sticker ROSA	1
81012	shelf for the stand FESTA 100 x 40 cm	8
81013	hook 10 cm	10
81014	hook 16 cm	10
81015	hook 20 cm	10
81035	hook with plastic price tag 20 cm	10
81016	hook 30 cm	10
81036	hook with plastic price tag 30 cm	10
81022	wire basket - big, 50 cm	1
81023	wire basket - small, 40 cm	1
81024	partition - big, 50 cm	1
81025	partition - small, 40 cm	1





RACKING SYSTEM SU - 5



WE CAN ALSO ARRANGE YOU REQUIRED SHELF ASSEMBLY

No.	specification	No.	specification	No.	specification
81200	Handstand 40/2400 mm anchored	81293	Simple hinge 100	81389	Rear panel 200/1250mm full
81201	Handstand 80/1108 mm	81294	Simple hinge 200	81390	Rear panel 400/1250mm full
81202	Handstand 80/1208 mm	81295	Simple hinge 300	81391	Rear panel 200/1250mm perforated
81203	Handstand 80/1408 mm	81296	Hook with horizontal bar 200	81393	Cover gondolas 80/1250mm
81204	Handstand 80/1608 mm	81297	Hook with horizontal bar 300	81392	Rear panel 400/1250mm perforated
81205	Handstand 80/1808 mm	81298	Lock showcase	81394	Cover gondolas 60/1250mm
81206	Handstand 80/2000 mm	81299	Hyphen wire 360mm high	81395	Beam hinges 1250mm
81207	Handstand 80/2108 mm	81300	Hyphen wire 460 mm high	81396	Shelf 200/1250mm
81208	Handstand 80/2208 mm	81301	Hyphen wire 560 mm high	81439	Beam hinges 1000 mm
81209	Handstand 80/2308 mm	81302	Hyphen wire 560 mm nízke	81344	Shelf 300/1000 respecificationrced
81210	Handstand 80/2408 mm	81303	Bracket 300 double L	81345	Shelf 400/1000 respecificationrced
81211	Handstand 80/2600 mm	81304	Bracket 300 double P	81346	Shelf 500/1000 respecificationrced
81212	Handstand 60/1000 mm	81305	Bracket 400 double L	81397	Shelf 300/1250mm
81213	Handstand 60/1208 mm	81306	Bracket 400 double P	81400	Shelf 300/1250mm, respecificationrced
81214	Handstand 60/1408 mm	81307	Bracket 500 double L	81401	Shelf 400/1250mm, respecificationrced
81215	Handstand 60/1608 mm	81308	Bracket 500 double P	81402	Shelf 500/1250mm, respecificationrced
81216	Handstand 60/1808 mm	81309	Shelf semicircle 300	81398	Shelf 400/1250mm
81217	Handstand 60/2108 mm	81310	Shelf semicircle 400	81399	Shelf 500/1250mm
81218	Handstand 60/2208 mm	81311	Shelf semicircle 500	81404	Front fulcrum low 1250mm, white plastic
81225	Handstand 30/2108 mm front	81312	Sokl pülkruhu 500	81405	Price bar, 1250mm
81486	Handstand 60/2000 mm	81313	Forehead base semicircle 500	81406	Comb 1250mm
81219	Adapter of handstand 80x30/100mm	81314	Bracket 300 price tag semicircle	81407	Price tag holder, 1250mm
81220	Adapter of handstand 80x30/400 mm	81315	Bracket 400 price tag semicircle	81408	Forehead roofing, 1250mm
81221	Adapter of handstand 80x30/600 mm	81316	Bracket 500 price tag semicircle	81409	Tile roofing, 600x1250mm
81222	Adapter of handstand 60x30/400 mm	81317	Shelf semicircle 600	81410	Rear panel 100/625 full
81223	Corner handstand 90° 2100mm	81318	Plinth semicircle 600	81411	Rear panel 200/625 full
81224	Corner handstand 90° 2200mm	81319	Forehead base semicircle 600	81412	Rear panel 400/625 full
81226	Support 80	81320	Price tag P 7,5x5 cm	81413	Rear panel 400/625 perforated
81227	Support 60	81321	Price tag P 2,6x3,2 cm	81414	Cover gondolas 80/650
81228	Clutch gondolas with a shelf 80	81322	Price tag P 5,0x4,0 cm	81415	Cover gondolas 60/650
81229	Anchor bar	81323	Perforated shelf 500/1000	81416	Beam hinges, module 3
81230	Anchor hook	81324	Connector upright 80, Module 1	81432	Beam hinges, 1330mm
81231	Anchoring light	81325	Rear panel 10x100cm	81417	Shelf 300/625
81232	Anchoring top	81326	Rear panel 20x100cm	81418	Shelf 400/625
81233	Filling 400	81327	Rear panel 40x100cm	81419	Shelf 500/625
81234	Filling 500	81328	Perforated rear panel 20x100 cm EUR	81421	Front support low 625, white plastic
81235	Filling 600	81329	Perforated rear panel 40x100 cm EUR	81422	Price bar 625mm
81236	Filling 700	81330	Cover gondolas 8x100cm	81423	Comb 625mm
81237	Filling 800	81331	Cover gondolas 6x100cm	81424	Price tag holder, 625mm
81238	Console low 200	81332	Beam hinges 100cm	81425	Rear panel 100/1330 full
81239	Console low 300	81333	Glass shelf 985/300 vitrine	81457	Molded plastic abutment low 200
81240	Console low 400	81334	Glass shelf 985/400 vitrine	81426	Rear panel 200/1330 full
81241	Console low 500	81335	Wooden shelf 47/98,5	81427	Rear panel 400/1330 full
81242	Console high 400	81336	Wire shelf 1000/500	81428	Rear panel 200/1330 perforated S
81243	Console high 500	81337	Troughed shelf 1000x500	81429	Rear panel 400/1330 perforated S
81244	Console high 600	81338	Shelf 200/1000	81430	Cover gondolas 80/1330
81245	Console high 700	81339	Shelf 300/1000	81431	Cover gondolas 60/1330
81246	Console low 300 double	81340	Shelf 400/1000	81433	Shelf 300/1330
81247	Console low 400 double	81341	Shelf 500/1000	81434	Shelf 400/1330
81248	Console low 300 double	81342	Shelf 400/1000 RAL7015	81435	Shelf 500/1330
81251	Console RR 80	81343	Shelf 500/1000 RAL7015	81436	Price bar, 1330 mm
81249	Console high double 500	81347	High frame showcases 1000/400	81437	Comb 1330 mm
81250	Beam showcase 400/2000	81348	Glass frame high showcases 1000/400	81438	Price tag holder 1330 mm
81252	Hyphen trough shelves	81349	Female insert shelf	81440	Wire shelf - basket
81253	Hyphen low 300	81350	Suspended ceiling metal shelves 500/100	81441	Rear panel 100 fillet
81254	Hyphen low 400	81352	Front support high glass 1000 mm	81442	Rear panel 400 fillet
81255	Hyphen low 500	81353	Front support high plexi	81443	Forehead plinth fillet 500/1000mm
81256	Hyphen low 300 glass	81354	Front support low plastic 1000 mm	81444	Forehead plinth fillet 600 mm
81257	Hyphen low 400 glass	81355	Price bar, 1000mm	81445	Rear panel fillet 400mm perforated
81258	Hyphen low 500 glass	81356	Comb socket rack	81447	Shelf 300 fillet
81259	Hyphen high 300 glass	81351	Comb for high dividers, 1000	81448	Shelf 400 fillet
81262	Hyphen high 300 plexi	81357	Comb, 1000 mm	81449	Shelf 500 fillet
81263	Hyphen high 400 plexi	81403	Comb for high dividers, 1250 mm	81450	Shelf 600 fillet
81264	Hyphen high 500 plexi	81420	Comb for high dividers, 625 mm	81451	Price tag holder 300 fillet
81260	Hyphen high 400 glass	81358	Double-groove door showcases	81452	Price tag holder 400 fillet
81261	Hyphen high 500 glass	81359	Price tag holder, 1000mm	81453	Price tag holder 500 fillet
81265	Side of showcase 400/2000	81360	Door showcases 1000/2000	81454	Price bar 300 fillet
81266	Sidewall roofing RR 80	81361	Forehead roofing, 1000mm	81455	Price bar 400 fillet
81267	Sidewall tray 500mm	81362	Tile roofing, 1000mm	81456	Price bar 500 fillet
81268	Sidewall showcase 500	81363	Tray door	81458	Wire shelf basket U 1000/400
81269	Beam showcase 500	81364	Sliding door showcases	81459	Wire shelf basket U 1000/500
81271	Sidewall shelves low 300 plastic	81365	Mirror showcases	81460	Corner forehead plinth 90°
81272	Sidewall shelves low 400 plastic	81366	Hinge frame, module 1	81461	Rear corner panel 100, stand 60
81273	Sidewall shelves low 500 plastic	81367	Curtain rod	81462	Rear corner panel 200, stand 60
81274	Sidewall high glass 300/250	81370	Trash wire oblique	81463	Rear corner panel 400, stand 80
81275	Safety fuse	81371	Tour 1000mm full plate	81466	Rear corner panel 100, stand 80
81276	Sidewall high glass 500/250	81372	Skirting the counter SU 5 1000mm	81467	Rear corner panel 400, stand 60
81277	Sidewall shelves high 400	81373	Counter glassed 1000mm	81468	Police corner 90° 400mm
81278	Sidewall shelves high 500	81374	Counter with stainless steel plate 1000mm	81469	Police corner 90° 500mm
81270	Beam roofing RR 80	81375	Counter with full plate 600mm	81470	Price tag holder corner 90° 400mm
81279	Beam roofing	81376	Shelf counter 600mm	81471	Price tag holder corner 90° 500mm
81280	Sidewall roofing left	81377	Counter glassed 600mm	81472	Price bar fillet 90° 400mm
81281	Sidewall roofing right	81378	Shelf counter 1000mm	81473	Price bar fillet 90° 500mm
81282	Suspension arm	81379	Long shelf counter		
81284	Double shoulder 400/10	81380	Segment counter high 90°		
81285	Double shoulder 300/8	81381	Double-groove counter 1000mm, couple		
81286	Simple shoulder 350	81382	Sliding doors counter 1000mm, couple		
81287	Simple shoulder 500	81383	Drawer board		
81288	Simple shoulder 250	81384	Wire shelf RDE 1000/360mm		
81289	Double hinge 100	81385	Wire shelf RDE 1000/460mm		
81290	Double hinge 200	81386	Wire shelf RDE 1000/560mm		
81291	Double hinge 300	81387	Price bar RDE 1000 mm		
81292	Hinge 130 V	81388	Rear panel 100/1250mm full		

TRADE BRACKET

· compatible with FESTA stand

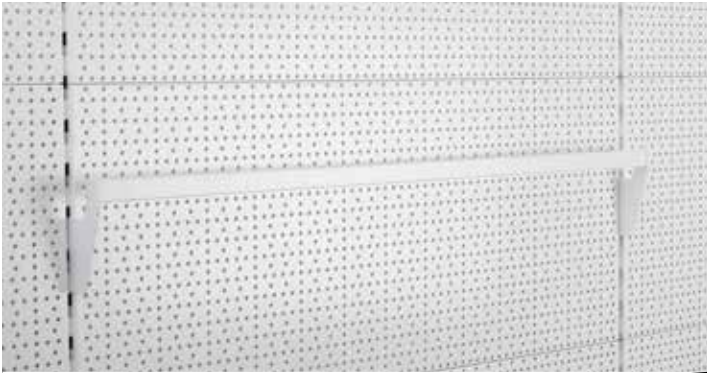

No.	specification	
81150	1000 × 50 × 135 mm	1

TRADE BRACKET

· compatible with FESTA stand

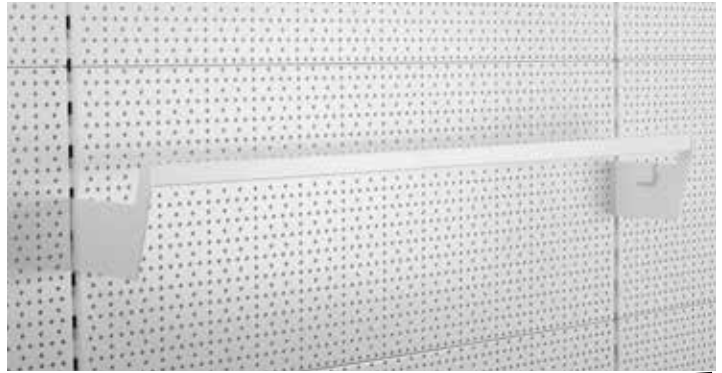

No.	specification	
81151	1000 × 150 × 135 mm	1

TRADE BRACKET

· compatible with FESTA stand

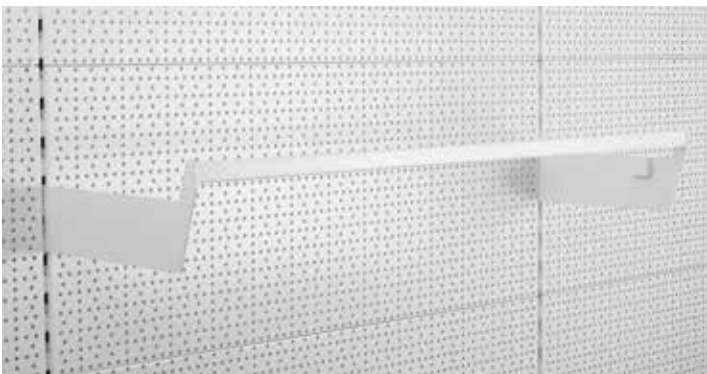

No.	specification	
81152	1000 × 350 × 135 mm	1

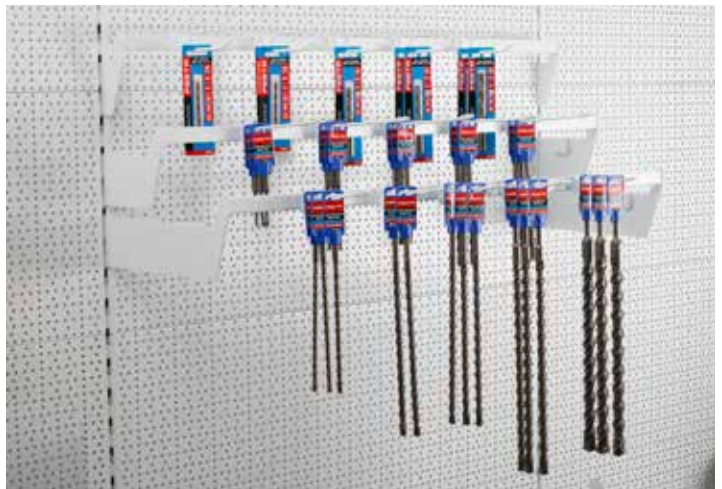

PRICE HOLDER

· compatible with FESTA stand



No.	specification	
81155	1000 × 80 × 100 mm	1

FRAME FOR CUTTING DISCS

· compatible with FESTA stand

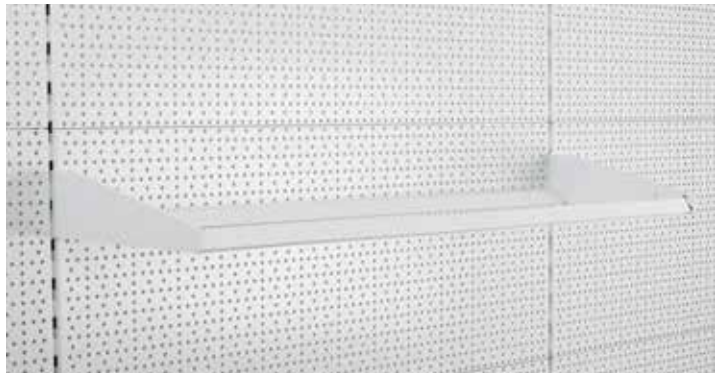

No.	specification	
81170	1000 × 450 × 85 mm	1

HOOK FOR CUTTING DISCS

· compatible with FESTA stand

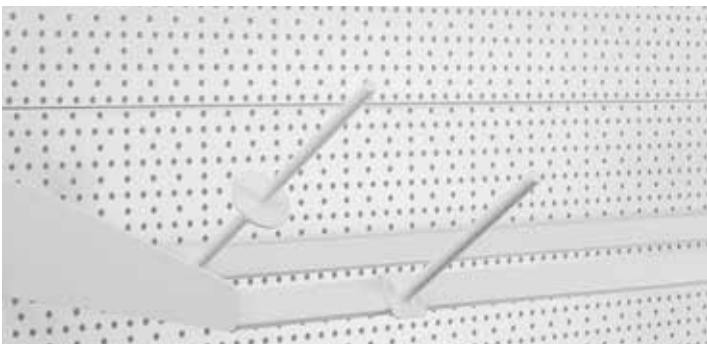

No.	specification	
81186	150 mm	1
81185	250 mm	1

HOOK FOR CORDLESS TOOLS

· compatible with FESTA stand



No.	specification	
81189		1

SAWS HOLDER

· compatible with FESTA stand

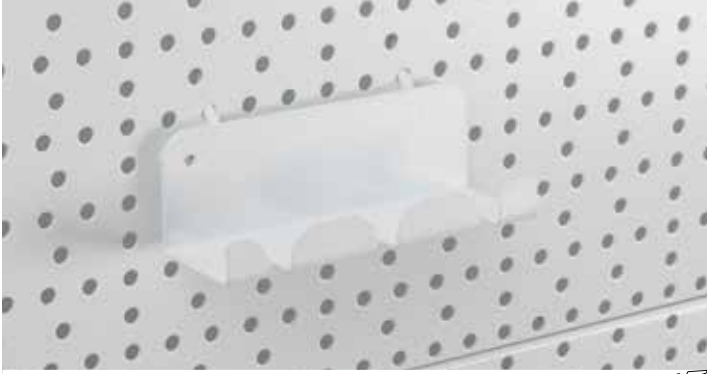

No.	specification	
81190		1

SHELF FOR DISCS

· compatible with FESTA stand



No.	specification	
81191	220 × 220 × 200 mm	1

WIRE BASKET

· compatible with FESTA stand

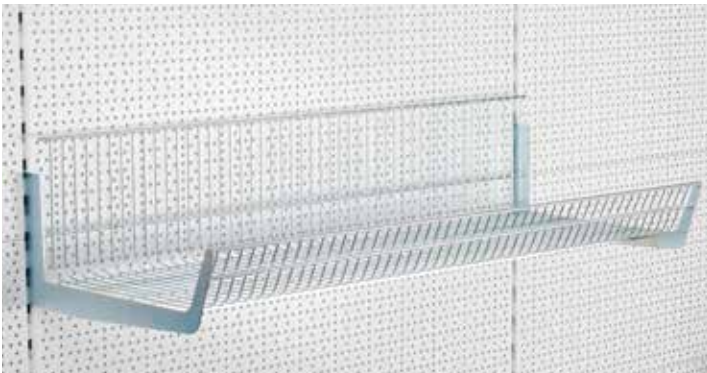

No.	specification	
81160	1000 × 470 × 180 mm	1



DIVIDER

· compatible with FESTA stand



No.	specification	
81165	470 × 180 mm	1

HOOK FOR HORIZONTAL BAR

· compatible with FESTA stand

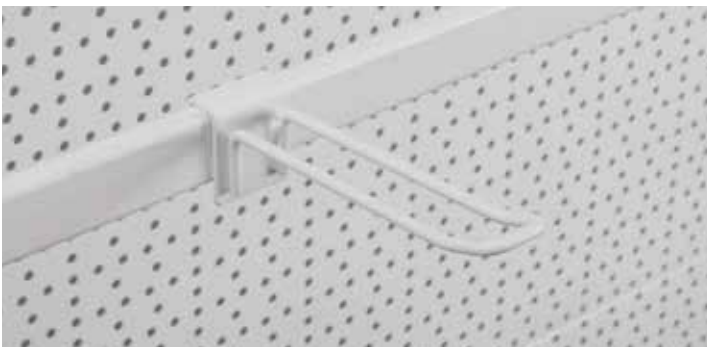

No.	specification	
81175	120 mm	1
81178	180 mm	1

HOOK FOR HORIZONTAL BAR

· compatible with FESTA stand



No.	specification	
81180	120 mm	1

STAINLESS TROWEL



INOX



No.	specification	
33100	130 x 270 mm straight, 2 round corners	1

STAINLESS TROWEL



INOX



No.	specification	
33102	130 x 270 mm straight, G-1 handle	1

STAINLESS TROWEL



INOX



No.	specification	
33105	130 x 350 mm straight, G-8 handle	1

STAINLESS TROWEL



INOX



No.	specification	
33107	110 x 270 mm corner	1

STAINLESS TROWEL



INOX



No.	specification	
33110	130 x 270 mm straight, G-11 handle	1

STAINLESS TROWEL



INOX



No.	specification	
33112	130 x 270 mm teeth 6 x 6, G-11 handle	1
33113	130 x 270 mm teeth 8 x 8, G-11 handle	1
33114	130 x 270 mm teeth 10 x 10, G-11 handle	1

STAINLESS TROWEL



INOX



No.	specification	
33120	130 x 480 mm straight, G-12 handle	1

STAINLESS TROWEL



INOX



No.	specification	
33123	130 x 480 mm teeth 8 x 8, G-12 handle	1
33124	130 x 480 mm teeth 10 x 10, G-12 handle	1

STAINLESS TROWEL



INOX



No.	specification	
33127	130 x 480 mm 2 round corners	10

STAINLESS TROWEL



INOX



No.	specification	
33131	80 x 200 mm G-1 handle	10
33132	75 x 95 x 240 mm trapezoidal G-1 handle	10

STAINLESS TROWEL



INOX



No.	specification	
33135	130 x 270 mm oblique tooth 8 mm, G-1 handle	10

STAINLESS TROWEL



INOX



No.	specification	
33137	130 x 270 mm teeth half round, G-1 handle	10

TROWEL



INOX



No.	specification	
33140	50 mm	20
33141	60 mm	20
33142	80 mm	20
33143	100 mm	20

PLASTIC TROWEL ABS



No.	specification	
33150	130 x 240 mm	12

PLASTIC TROWEL

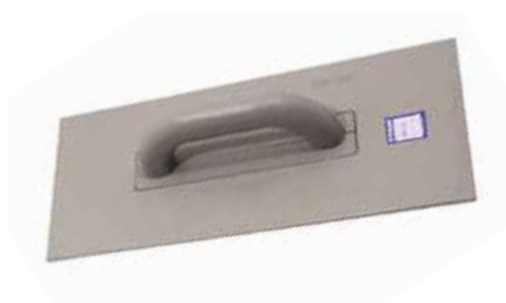

No.	specification	
33151	180 x 400 mm	1
33152	130 x 600 mm	1

PLASTIC TROWEL



No.	specification	
33154	130 x 270 mm G-17 handle	12

BAR TROWEL



Zn

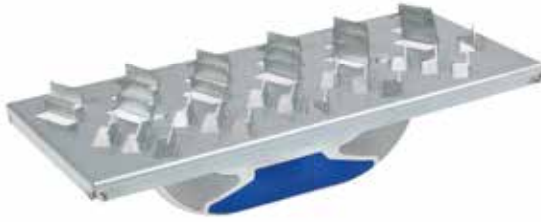

MOQ
2

No.	specification	
32328	285 x 145 mm	10

TROWEL FOR SANDING GRID



No.	specification	
33160	105 x 210 mm with rubber layer	20

GRINDING TROWEL



INOX



MOQ
2

No.	specification	
33162	130 x 270 mm	20
33163	180 x 400 mm	10
33164	160 x 380 mm	10

GRINDING TROWEL



MOQ
2

No.	specification	
33165	165 x 365 mm	10

GRINDING TROWEL



INOX



MOQ
2

No.	specification	
33166	130 x 600 mm	2

GRINDING TROWEL



MOQ
2

No.	specification	
33167	130 x 270 mm G-17 handle	20
33168	160 x 380 mm G-17 handle	10
33170	180 x 400 mm G-17 handle	10

GRINDING TROWEL



MOQ
2

No.	specification	
33169	160 x 380 mm perforated G-16 handle	10

PLASTIC SCRAPER WITH STUDS



MOQ
2

No.	specification	
33173		2

STAINLESS SPATULA



INOX



No.	specification	
33200	40 mm	20
33201	60 mm	20
33202	80 mm	20
33203	100 mm	20

STAINLESS SPATULA



INOX



No.	specification	
33205	130 x 90 mm	20

STAINLESS SPATULA



INOX



No.	specification	
33206	130 x 37 mm	20

STAINLESS SPATULA



INOX



No.	specification	
33207	150 mm with screwdriver	30

STAINLESS SPATULA



INOX



No.	specification	
33208	350 x 90 mm	10

STAINLESS SPATULA



INOX



No.	specification	
33209	335 x 37 mm	20

STAINLESS SPATULA



INOX



No.	specification	
33210	150 mm G-15 handle	10
33211	250 mm G-15 handle	10
33212	350 mm G-15 handle	10

STAINLESS SPATULA



INOX



No.	specification	
33215	600 mm AL, G-14 handle	10

PLASTIC SPATULA



PLASTIC SPATULA



No.	specification		
33220	145 mm with rubber		10

No.	specification		
33221	245 mm with rubber		10

PLASTIC TROWEL, RUBBER



TILING SET



No.	specification		
33155	95 x 240 mm with rubber layer		5

No.	specification		
33250			1

BUCKET



TILING SET MINI



No.	specification		
33254	16 l grid and wheels		1
33255	20 l grid and wheels		1

No.	specification		
33252			1

PARTS FOR WASHING SETS



PARTS FOR WASHING SETS



No.	specification		
33257	triple roller for bucket		1

No.	specification		
33256	roller for bucket		1
33258	roller for bucket		1

SPACERS SMART LEVEL



100x



leveling wedges 37715, 33246



No.	specification	
33247	1 mm	15
33248	2 mm	15
33249	3 mm	15

LEVELING WEDGES



50x



No.	specification	
33246	Smart Level	15

DIPPER PLASTIC



RUBBER BOWL



RUBBER SPATULA



No.	specification	
33270	175 mm	20

No.	specification	
33275	0,5 l	20

No.	specification	
33280	200 mm	10
37010	135 mm	20

LEVELING ROLLER



PAINT SCRAPER



No.	specification	
33289	85 x 230 mm	15

No.	specification	
33285	60 mm	1
33286	spare blade 60 mm	1

DRILL FOR POROUS



PLASTIC MITER BOX



No.	specification	
33291	60 mm	1
33292	80 mm	1
33293	120 mm	1

No.	specification	
33298	250 x 80 x 50 mm	1
33299	300 x 115 x 65 mm	1





AUTOMOTIVE

392 - 403



HYDRAULIC BOTTLE JACK, ONE PISTON



- extension screw allows low pickup height adjustment and maximum lift
- double safety bypass valve
- serrated saddle provides generous lifting area and secure grip
- a wide base provides stability and strength
- all models critical stress points are reinforced for added durability and dependability



No.	dimensions	capacity	min. height	lift	Adjust height	base dimensions	weight	
26800	Hydraulic bottle jack	2 000 kg	181mm	116 mm	48 mm	88 x 92 mm	2,6 kg	1
26801	Hydraulic bottle jack	3 000 kg	194 mm	118 mm	60 mm	92 x 100 mm	3,3 kg	1
26802	Hydraulic bottle jack	5 000 kg	216 mm	127 mm	70 mm	96 x 112 mm	4,5 kg	1
26803	Hydraulic bottle jack	8 000 kg	230 mm	147 mm	80 mm	103 x 118 mm	5,7 kg	1
26804	Hydraulic bottle jack	10 000 kg	230 mm	150 mm	80 mm	110 x 123 mm	6,8 kg	1
26805	Hydraulic bottle jack	12 000 kg	230 mm	155 mm	80 mm	116 x 134 mm	7,3 kg	1
26806	Hydraulic bottle jack	15 000 kg	230 mm	150 mm	80 mm	133 x 136 mm	8,4 kg	1
26807	Hydraulic bottle jack	20 000 kg	242 mm	150 mm	60 mm	144 x 152 mm	11 kg	1

HYDRAULIC BOTTLE JACK, DOUBLE PISTON



- extension screw allows low pickup height adjustment and maximum lift.
- double safety bypass valve.
- serrated saddle provides generous lifting area and secure grip.
- a wide base provides stability and strength
- all models critical stress points are reinforced for added durability and dependability.



No.	dimensions	capacity	min. height	lift	adjust height	weight	
26815	Double ram bottle jack	2 000 kg	150 mm	160 mm	60 mm	4,7 kg	1
26816	Double ram bottle jack	4 000 kg	160 mm	170 mm	60 mm	6,4 kg	1
26817	Double ram bottle jack	6 000 kg	215 mm	270 mm	-	8,9 kg	1
26819	Double ram bottle jack	10 000 kg	228 mm	284 mm	89 mm	10,2 kg	1

SCISSORS JACK



No.	dimensions	capacity	min. height	max. height	weight	
26844	Scissors Jack	1 000 kg	88 mm	380 mm	2,5 kg	1
26845	Scissors Jack	2 000 kg	120 mm	395 mm	3,5 kg	1

HYDRAULIC LIFTING JACK



No.	dimensions	capacity	min. height	max. height	weight	
26820	Hydraulic trolley jack 2t, portable	2 000 kg	130 mm	345 mm	9,6 kg	1
26826	Hydraulic garage jack, low profil, 360° rotating handle	2 000 kg	89 mm	359 mm	14,2 kg	1
26824	Hydraulic garage jack, foot handle	3 000 kg	145 mm	500 mm	37,2 kg	1
26825	Hydraulic garage jack, low profil, profi	2 500 kg	85 mm	455 mm	34,8 kg	1

HYDRAULIC LIFTING JACK, ALUMINUM, LOW PROFILE



No.	dimensions	capacity	min. height	max. height	
26840		2 000 kg	100 mm	465 mm	1

HYDRAULIC TROLLEY JACK + JACK STANDS



No.	dimensions	capacity	min. height	max. height	weight	
26829	Hydraulic trolley jack	2 000 kg	130 mm	350 mm	10,5 kg	1
	2pcs jack stands	2 000 kg	275 mm	420 mm	5 kg (pair)	

JACK STAND

- 1pc = 1pair
- ratchet type for fine adjustable with double locking protection
- solid steel handle
- large saddle, unitized frame construction
- ductile iron rack



No.	dimensions	capacity	min. height	max. height	weight	
26857	Jack stand - pair; with lock pin	2 000 kg	275 mm	420 mm	4,8 kg	1
26858	Jack stand - pair; with lock pin	3 000 kg	285 mm	425 mm	6,3 kg	1
26859	Jack stand - pair; with lock pin	6 000 kg	393 mm	593 mm	13 kg	1
26853	Jack stand - pair	12 000 kg	465 mm	715 mm	28 kg	1

HYDRAULIC CRANE JACK, FOLDABLE

- for lifting and fixing units during its mounting and demounting from cars
- crane boom has a few position of extension
- the crane can easily be folded for storage



No.	dimensions	capacity	min. height	max. height	weight	
26862	Hydraulic crane jack, foldable	2 000 kg	0	2360 mm	88 kg	1

ENGINE SUPPORT

- swinging suspension of the arm, depends on the cowl slope, ensuring always balanced and stable engine fixing



No.	dimensions	capacity	length	range	weight	
26871	Engine support	500 kg	1500 mm	150 mm	20,3 kg	1

HYDRAULIC TRANSMISSION JACK

- easy mounting and demounting units (engines, transmissions, axles etc.)

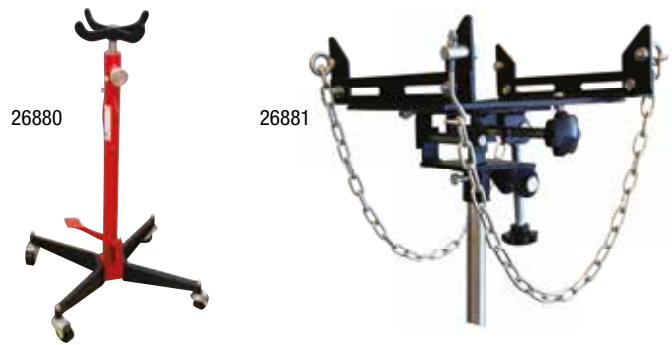

No.	dimensions	capacity	length	range	weight	
26880	Hydraulic transmission jack	500 kg	1100 mm	1900 mm	30,0 kg	1
26881	Automatic transmission jack extension	500 kg	1100 mm	1900 mm	15,0 kg	1

PORTABLE HYDRAULIC EQUIPMENT

- hydraulic equipment for repairing vehicle bodies
- it's provided with piston cylinder and 14 pcs accessories
- it is widel applicable to repair car and truck bodies, especially to field work without power suply
- during its use, the accessories can push, pull, lift and extend in vertical and horizontal directions
- easy transporting in blow mold case



No.	dimensions	capacity	hydraulic lift	weight	
26886	Portable hydraulic equipment	4 000 kg	125 mm	17,0 kg	1
26888	Portable hydraulic equipment	10 000 kg	135 mm	32,0 kg	1

ENGINE STAND

- movable stand for mounting and working on demounted engines
- universal clamping unit for fastening the engine and its rotating



No.	dimensions	capacity	weight	
26920	Engine stand, positioning, mobile	450 kg	20 kg	1
26921	Engine stand, positioning, mobile	560 kg	27 kg	1
26922	Engine stand, positioning, mobile, foldable	675 kg	35 kg	1

HAND WINCH

Zn

- high quality zinc-coated winch with durable wire rope



No.	dimensions	Cable diameter	Max.Capacity	Cable length	
26705	Hand winch	4,0mm	450 kg	10 m	1
26706	Hand winch	5,0mm	900 kg	10 m	1
26707	Hand winch	6,0mm	1350 kg	10 m	1
26720	Hand winch	4,0mm	300 kg	10 m	1
26721	Hand winch	4,0mm	500 kg	10 m	1
26722	Hand winch	5,0mm	800 kg	10 m	1

CHAIN JACK



No.	dimensions	Capacity	Min. height	Lift height	No.of chain block.	Chain Thickness	Weight	
26700	Chain jack	500 kg	280 mm	3 000 mm	1	6 mm	7,5 kg	1
26701	Chain jack	1 000 kg	300 mm	3 000 mm	1	6 mm	9 kg	1
26702	Chain jack	2 000 kg	380 mm	3 000 mm	2	6 mm	12 kg	1

SPRING COMPRESSOR

- 26897 - to replace mopherson struts/springs directly in the car.
- 26943 - to replace mopherson struts/springs outside the vehicle rugged steel profiles for higher stability.



No.	dimensions	Capacity	Ø Compressed Spring.	Compression Length	Weight	
26897	Portable spring compressor	1 000 kg	100-200 mm	150 mm	24,5 kg	1
26943	Spring compressor	1 000 kg	400 mm	210-570 mm	35 kg	1

HYDRAULIC SHOP PRESS



No.	dimensions	Range	Max.Capacity	Weight	
26940	Hydraulic shop press	0 - 610 mm	12 000 kg	43 kg	1
26941	Hydraulic shop press	0 - 880 mm	20 000 kg	75 kg	1

HYDRAULIC PIPE BENDER

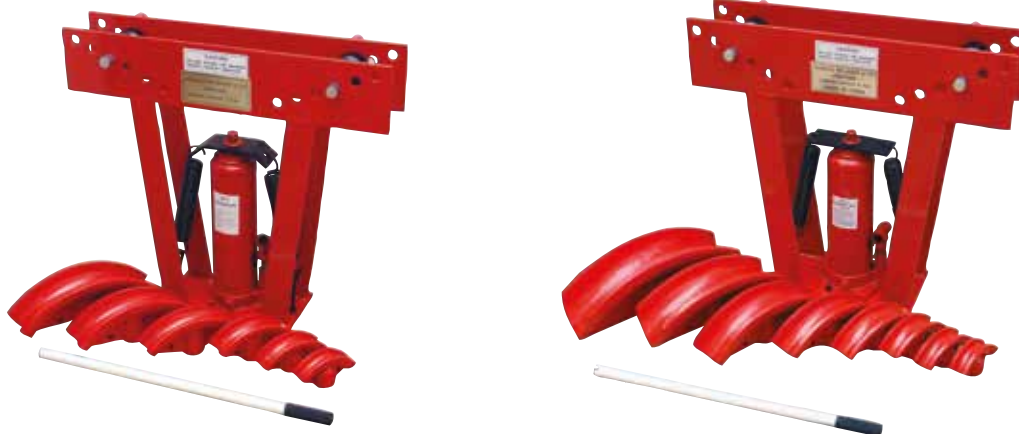

No.	dimensions	Capacity	Lift heigh	Bending shoes	Weight	
26895		12 000 kg	232 mm	1½", 3¼", 1", 1-1¼", 1-1½", 2"	36 kg	1
26896		16 000 kg	238 mm	1½", 3¼", 1", 1-1¼", 1-1½", 2", 2-1½", 3"	65 kg	1

HYDRAULIC LONG RAM

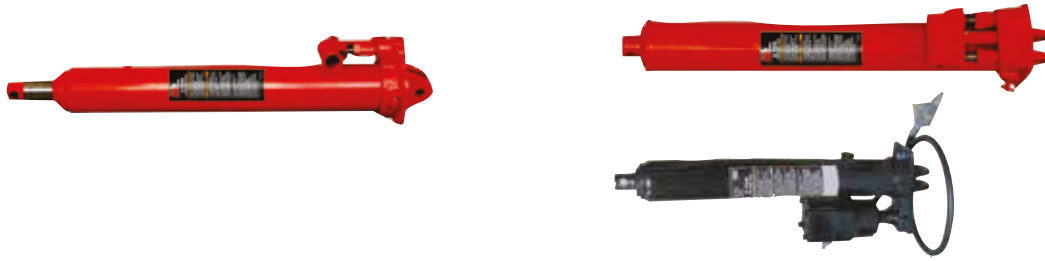

No.	dimensions	Capacity	Min.Length	Max.Length	Weight	
26911	Hydraulic long ram, single pump	5 000 kg	620	1100	12 kg	2
26912	Hydraulic long ram, single pump	8 000 kg	620	1100	13 kg	2
26914	Hydraulic long ram, double pump	5 000 kg	620	1100	12 kg	2
26915	Hydraulic long ram, double pump	8 000 kg	620	1100	14 kg	2

PARTS WASHER

· for common object washing (parts, accessories etc.)



No.	dimensions	Tank capacity	Solvent capacity	Flow rate	Max. solvent temperature	Weight	
26961	Parts washer	90 l	45 l	10-12 l/min.	50°C	25 kg	1
26963	Parts washer	180l	150 l	20 l/min	50°C	42 kg	1

OIL DRAINER TANK

WASTE OIL EXTRACTOR

- oil is drained from engine to collector through the dish
- collector is fitted with extraction equipment
- oil can be pumped from the collector with pressure air through a hose



No.	Cubage	Max.Pressure	Weight	
26953	90 l	0,2 MPa	22 kg	1



No.	Cubage	Max.Pressure	Weight	
26954	90 l	0,5 MPa	28 kg	1

TWO - LEG PULLER



No.	max. diameter	depth	
23734	Ø 100 mm	50-95 mm	1
23735	Ø 150 mm	100-150 mm	1
23736	Ø 200 mm	110-190 mm	1

THREE - LEG PULLER



No.	max. diameter	depth	
23730	Ø 100 mm	50-95 mm	12
23731	Ø 150 mm	100-150 mm	2
23732	Ø 200 mm	110-190 mm	2

HYDRAULIC PULLER

- hydraulic puller set, including hydraulic screw, full jaws as well as 3 triplets of arms and spans
- in steel case



No.	dimensions	Capacity	Weight	
26891	Universal hydraulic puller set	12 000 kg	18 kg	1

SANDBLASTING CABINET



SPARE PARTS FOR SANDBLASTING CABINET

No.	specification	
26973	gloves	1
26974	nozzles	1
26975	foil 53,5 x 26 cm	1
26976	plexiglass 60 x 30 cm	1
26977	glass 60 x 30 cm	1



No.	Air consumption	Outside dimensions	Inside dimensions	Max.Pressure	Weight	
26972	420-710 l/min.	1500 x 830 x 630 mm	600 x 840 x 630 mm	8 bar	38 kg	1

TOOL CABINET



No.	Drawers slides	Drawers	Overall dimensions (mm)	
26986	smooth	7	680 x 460 x 1020 mm	1

TOOL CABINET

· top chest can be put into roller cabinet



No.	dimensions	Drawers slides	Drawers	Drawers inside dimensions WxDxH (mm)	Overall dimensions (mm)	Total weight (kg)	
26985	top case	smooth	3	151,5 x 225 x 40 mm	600 x 260 x 340 mm	11,5 kg	1
			2	511 x 225 x 40 mm			
	bottom case	smooth	1	511 x 225 x 85 mm	616 x 330 x 742 mm	16,4 kg kg	
			2	511 x 308 x 85 mm			

MAGNETIC TRAY

TIGHTENING EQUIPMENT



No.	inside dimensions		No.	inside dimensions	
26996	200 x 20 mm	1	50035	2 t	6
			50036	4 t	4

KNEELING CREEPER



No.	Dimensions	Icon
37135		1

CAR CREEPER

- padded car creeper



No.	Dimensions	Icon
26936	930 x 440 x 105 mm	1

CAR CREEPER

- plastic car creeper with padded head rest
- side tool trays



No.	Dimensions	Icon
26934	1030 x 450 x 105 mm	1

CAR CREEPER

- padded car creeper with adjustable head rest and side tool trays



No.	Dimensions	Icon
26938	1030 x 440 x 105 mm	1

CAR CREEPER

- padded roller seat with plastic tool tray.



No.	Dimensions	Icon
26988	360 x 365 x 365 mm	1

MINI ENGINE STAND



No.	Dimensions	Icon
26979		1

MINI MOTORCYCLE LIFT JACK



No.	Dimensions	Icon
26997		1

MINI ENGINE HOIST



No.	Dimensions	Icon
26998		1

number of item	page	number of item	page	number of item	page	number of item	page	number of item	page	number of item	page
10002	4 B	12050	9 B	13284	32 B	13462	11 B	14380	13 B	15535	18 B
10003	4 B	12110	9 B	13285	35 B	13463	11 B	14399	13 B	15540	18 B
10005	4 B	12120	9 B	13290	70 C	13464	11 B	14410	14 B	15615	18 B
10008	4 B	12130	9 B	13293	70 C	13465	11 B	14411	14 B	15620	18 B
10025	4 B	12150	9 B	13294	70 C	13466	11 B	14420	13 B	15625	18 B
10033	4 B	12210	9 B	13295	37 B	13467	11 B	14421	13 B	15630	18 B
10035	4 B	12220	9 B	13296	37 B	13468	11 B	14425	14 B	15710	18 B
10043	4 B	12230	9 B	13350	36 B	13469	11 B	14430	14 B	15715	18 B
10045	4 B	12250	9 B	13351	36 B	13470	11 B	14435	14 B	15720	18 B
10048	4 B	12433	9 B	13352	36 B	13471	11 B	14440	14 B	15725	18 B
10110	5 B	12435	9 B	13353	36 B	13472	11 B	14450	13 B	15730	18 B
10120	5 B	13010	10 B	13354	36 B	13473	11 B	14451	13 B	15735	18 B
10130	5 B	13020	10 B	13355	36 B	13500	8 B	14455	14 B	15740	18 B
10330	5 B	13021	10 B	13360	36 B	13501	8 B	14456	14 B	15810	19 B
10332	5 B	13022	10 B	13361	36 B	13502	8 B	14457	14 B	15812	19 B
10334	5 B	13023	10 B	13362	36 B	13503	8 B	14458	14 B	15815	19 B
10336	5 B	13030	10 B	13363	36 B	13504	8 B	14471	14 B	15818	19 B
10430	5 B	13111	10 B	13364	36 B	13505	8 B	14472	14 B	15820	19 B
10450	5 B	13120	10 B	13365	36 B	13506	8 B	14473	14 B	15825	19 B
10490	5 B	13205	35 B	13399	11 B	13507	8 B	14474	14 B	15830	19 B
10996	5 B	13210	10 B	13400	11 B	13508	8 B	14480	10 B	15850	19 B
10998	5 B	13211	10 B	13401	11 B	13509	8 B	14490	14 B	15853	19 B
10999	5 B	13212	35 B	13402	11 B	13510	8 B	14491	14 B	15855	19 B
11002	7 B	13214	34 B	13403	11 B	13511	8 B	14492	14 B	15860	19 B
11003	7 B	13216	34 B	13404	11 B	13512	8 B	14493	14 B	15870	19 B
11005	7 B	13217	34 B	13405	11 B	13513	8 B	14494	14 B	15880	19 B
11006	7 B	13218	34 B	13406	11 B	13514	8 B	15003	16 B	15885	225 E
11007	7 B	13219	34 B	13407	11 B	13515	8 B	15004	16 B	15886	225 E
11008	7 B	13220	10 B	13408	11 B	13516	8 B	15005	16 B	15886	345 F
11082	7 B	13222	34 B	13409	11 B	13517	8 B	15006	16 B	15887	225 E
11083	7 B	13223	34 B	13410	11 B	13518	8 B	15008	16 B	15887	345 F
11085	7 B	13224	34 B	13411	11 B	13519	8 B	15010	16 B	15888	225 E
11102	7 B	13225	34 B	13412	11 B	13520	8 B	15012	16 B	15888	345 F
11103	7 B	13226	34 B	13413	11 B	13521	8 B	15015	16 B	15889	225 E
11105	7 B	13227	34 B	13414	11 B	13522	8 B	15018	16 B	15904	20 B
11106	7 B	13228	34 B	13415	11 B	13523	8 B	15020	16 B	15906	20 B
11107	7 B	13229	34 B	13416	11 B	13524	8 B	15033	15 B	15908	20 B
11110	7 B	13230	34 B	13417	11 B	13525	8 B	15034	15 B	15910	20 B
11200	7 B	13231	34 B	13418	11 B	13526	8 B	15035	15 B	15912	20 B
11201	7 B	13235	34 B	13419	11 B	13527	8 B	15036	15 B	15915	20 B
11202	7 B	13236	34 B	13420	11 B	13528	8 B	15037	15 B	15920	20 B
11204	7 B	13237	34 B	13421	11 B	13529	8 B	15039	15 B	15954	20 B
11205	7 B	13238	34 B	13422	11 B	13530	8 B	15103	16 B	15956	20 B
11206	7 B	13240	33 B	13423	11 B	13531	8 B	15104	16 B	15958	20 B
11207	7 B	13241	33 B	13424	11 B	13532	8 B	15105	16 B	15960	20 B
11208	7 B	13242	33 B	13425	11 B	13533	8 B	15106	16 B	15962	20 B
11209	7 B	13243	33 B	13426	11 B	13534	8 B	15108	16 B	15965	20 B
11210	7 B	13244	33 B	13427	11 B	14001	12 B	15110	16 B	15970	20 B
11220	6 B	13245	33 B	13428	11 B	14002	12 B	15112	16 B	15980	22 B
11221	6 B	13249	36 B	13429	11 B	14003	12 B	15115	16 B	15981	22 B
11226	6 B	13250	36 B	13430	11 B	14004	12 B	15118	16 B	15983	9 B
11239	6 B	13251	36 B	13431	11 B	14006	12 B	15120	16 B	15985	9 B
11259	6 B	13252	36 B	13432	11 B	14007	12 B	15204	17 B	15988	9 B
11260	6 B	13253	36 B	13433	11 B	14008	12 B	15205	17 B	15989	9 B
11311	8 B	13254	36 B	13434	11 B	14009	12 B	15206	17 B	15990	22 B
11312	8 B	13255	37 B	13435	11 B	14010	10 B	15208	17 B	15991	22 B
11313	8 B	13256	37 B	13436	11 B	14011	10 B	15210	17 B	15992	22 B
11314	8 B	13257	37 B	13437	11 B	14012	10 B	15212	17 B	15993	22 B
11323	6 B	13258	37 B	13438	11 B	14013	12 B	15215	17 B	15996	19 B
11325	6 B	13259	37 B	13439	11 B	14015	10 B	15218	17 B	15997	19 B
11327	6 B	13260	33 B	13440	11 B	14017	10 B	15220	17 B	15998	19 B
11333	7 B	13261	33 B	13441	11 B	14019	10 B	15230	17 B	15999	19 B
11335	7 B	13262	32 B	13442	11 B	14025	14 B	15235	17 B	16002	136 D
11337	7 B	13263	32 B	13443	11 B	14030	10 B	15310	17 B	16003	136 D
11338	7 B	13264	32 B	13444	11 B	14035	12 B	15315	17 B	16004	137 D
11343	6 B	13265	32 B	13445	11 B	14040	12 B	15318	17 B	16005	137 D
11345	6 B	13266	32 B	13446	11 B	14045	12 B	15320	17 B	16006	137 D
11347	6 B	13268	32 B	13447	11 B	14060	13 B	15325	17 B	16010	137 D
11353	6 B	13269	32 B	13448	11 B	14070	13 B	15330	17 B	16010	137 D
11355	6 B	13270	32 B	13449	11 B	14075	13 B	15335	17 B	16011	136 D
11356	6 B	13271	32 B	13450	11 B	14080	12 B	15340	17 B	16011	136 D
11358	6 B	13272	32 B	13451	11 B	14090	14 B	15415	18 B	16011	137 D
11360	6 B	13273	33 B	13452	11 B	14091	14 B	15418	18 B	16012	136 D
11410	8 B	13274	33 B	13453	11 B	14220	13 B	15420	18 B	16012	136 D
11416	7 B	13275	33 B	13454	11 B	14225	13 B	15425	18 B	16012	137 D
11420	8 B	13276	33 B	13455	11 B	14230	13 B	15430	18 B	16013	137 D
11425	8 B	13277	33 B	13456	11 B	14235	13 B	15510	18 B	16013	137 D
11444	8 B	13278	32 B	13457	11 B	14240	13 B	15515	18 B	16014	137 D
11445	8 B	13279	32 B	13458	11 B	14250	13 B	15518	18 B	16016	137 D
12010	9 B	13280	32 B	13459	11 B	14350	13 B	15520	18 B	16017	137 D
12020	9 B	13281	35 B	13460	11 B	14360	13 B	15525	18 B	16019	136 D
12030	9 B	13282	35 B	13461	11 B	14370	13 B	15530	18 B	16021	143 D

LIST OF ITEMS



number of item	page	number of item	page	number of item	page	number of item	page	number of item	page	number of item	page
16022	147 D	16147	140 D	17026	153 D	17128	42 C	17259	85 C	17422	63 C
16023	141 D	16150	138 D	17027	153 D	17130	42 C	17260	84 C	17427	64 C
16024	143 D	16151	138 D	17028	47 C	17133	42 C	17261	69 C	17450	69 C
16025	140 D	16198	150 D	17029	47 C	17135	42 C	17262	69 C	17451	69 C
16026	143 D	16199	150 D	17033	44 C	17137	42 C	17292	59 C	17455	64 C
16028	143 D	16201	147 D	17034	46 C	17138	42 C	17294	59 C	17456	64 C
16029	140 D	16209	149 D	17035	46 C	17140	40 C	17295	59 C	17460	66 C
16030	142 D	16210	148 D	17036	46 C	17141	40 C	17296	59 C	17461	66 C
16031	142 D	16211	148 D	17038	47 C	17142	40 C	17297	59 C	17462	66 C
16032	142 D	16212	147 D	17039	47 C	17145	40 C	17298	59 C	17463	66 C
16033	142 D	16218	148 D	17040	43 C	17146	40 C	17299	59 C	17464	66 C
16034	140 D	16219	148 D	17041	43 C	17148	40 C	17300	46 C	17465	66 C
16035	142 D	16220	148 D	17042	43 C	17155	49 C	17301	46 C	17466	66 C
16036	142 D	16221	148 D	17043	43 C	17156	49 C	17302	46 C	17467	66 C
16037	141 D	16222	149 D	17044	43 C	17158	50 C	17304	46 C	17468	66 C
16038	142 D	16223	149 D	17045	43 C	17159	50 C	17305	46 C	17469	66 C
16041	142 D	16224	149 D	17046	47 C	17160	50 C	17308	60 C	17470	66 C
16042	144 D	16225	147 D	17048	47 C	17165	49 C	17309	60 C	17471	66 C
16042	251 E	16226	149 D	17050	50 C	17167	49 C	17310	60 C	17472	66 C
16043	143 D	16227	149 D	17050	153 D	17169	49 C	17311	60 C	17473	66 C
16046	143 D	16228	149 D	17051	47 C	17170	49 C	17312	60 C	17475	67 C
16049	144 D	16229	147 D	17052	47 C	17175	49 C	17313	60 C	17476	67 C
16050	144 D	16230	147 D	17053	47 C	17177	49 C	17314	60 C	17480	66 C
16051	144 D	16231	99 C	17054	47 C	17180	42 C	17315	60 C	17481	66 C
16052	144 D	16231	147 D	17055	47 C	17181	42 C	17316	60 C	17482	66 C
16053	143 D	16232	42 C	17056	47 C	17182	152 D	17317	60 C	17483	66 C
16054	144 D	16232	150 D	17057	47 C	17183	152 D	17318	60 C	17484	66 C
16055	143 D	16234	147 D	17058	47 C	17185	50 C	17319	60 C	17485	66 C
16056	251 E	16235	148 D	17059	44 C	17186	49 C	17320	60 C	17486	66 C
16057	141 D	16236	148 D	17060	44 C	17187	113 C	17321	60 C	17487	65 C
16058	141 D	16281	151 D	17061	44 C	17188	113 C	17322	60 C	17488	65 C
16059	144 D	16282	151 D	17062	44 C	17189	113 C	17324	60 C	17489	65 C
16060	146 D	16300	154 D	17063	45 C	17190	43 C	17327	60 C	17490	65 C
16061	146 D	16301	154 D	17064	45 C	17191	43 C	17330	60 C	17491	65 C
16062	145 D	16303	154 D	17065	45 C	17192	43 C	17332	60 C	17492	65 C
16063	145 D	16304	154 D	17066	45 C	17193	43 C	17333	60 C	17493	65 C
16064	145 D	16310	154 D	17067	45 C	17197	66 C	17334	60 C	17494	65 C
16065	145 D	16310	154 D	17068	45 C	17198	66 C	17335	55 C	17495	65 C
16066	138 D	16311	154 D	17069	45 C	17199	66 C	17336	55 C	17496	65 C
16066	145 D	16311	154 D	17070	45 C	17200	66 C	17337	55 C	17501	68 C
16067	145 D	16311	154 D	17071	45 C	17201	66 C	17338	55 C	17506	67 C
16068	145 D	16312	154 D	17072	45 C	17202	66 C	17345	54 C	17508	67 C
16069	144 D	16312	154 D	17075	45 C	17203	69 C	17346	54 C	17512	67 C
16070	144 D	16315	153 D	17076	45 C	17204	69 C	17350	88 C	17526	67 C
16070	146 D	16315	153 D	17077	45 C	17205	69 C	17351	88 C	17528	67 C
16071	141 D	16320	154 D	17079	44 C	17206	69 C	17352	88 C	17532	67 C
16071	146 D	16401	50 C	17080	44 C	17208	55 C	17353	88 C	17533	67 C
16072	146 D	16405	50 C	17081	44 C	17210	51 C	17357	88 C	17534	67 C
16073	146 D	16406	50 C	17082	44 C	17211	51 C	17359	88 C	17539	67 C
16074	141 D	16407	50 C	17083	46 C	17212	52 C	17360	88 C	17548	65 C
16074	146 D	16408	50 C	17084	44 C	17213	52 C	17361	88 C	17549	65 C
16075	146 D	16420	50 C	17085	44 C	17214	52 C	17380	64 C	17550	65 C
16077	145 D	16990	151 D	17086	44 C	17215	52 C	17381	64 C	17551	65 C
16078	145 D	16990	306 F	17089	48 C	17216	53 C	17382	63 C	17552	65 C
16081	145 D	16991	151 D	17090	48 C	17217	53 C	17383	63 C	17553	65 C
16082	144 D	16991	306 F	17091	48 C	17218	53 C	17384	63 C	17554	65 C
16083	146 D	16998	137 D	17092	48 C	17219	53 C	17385	63 C	17555	65 C
16084	146 D	16999	137 D	17093	48 C	17220	55 C	17386	63 C	17556	65 C
16085	141 D	17001	41 C	17094	41 C	17222	55 C	17390	64 C	17557	65 C
16086	141 D	17002	41 C	17095	41 C	17224	55 C	17391	64 C	17558	65 C
16090	139 D	17003	41 C	17096	41 C	17225	54 C	17392	64 C	17559	65 C
16091	139 D	17004	41 C	17097	41 C	17226	54 C	17393	64 C	17560	65 C
16095	141 D	17005	41 C	17098	41 C	17227	54 C	17394	64 C	17561	65 C
16100	138 D	17006	41 C	17099	41 C	17229	56 C	17395	64 C	17562	65 C
16104	136 D	17007	41 C	17100	41 C	17230	57 C	17396	64 C	17563	65 C
16105	138 D	17008	41 C	17101	40 C	17231	57 C	17397	64 C	17564	65 C
16110	138 D	17009	41 C	17102	40 C	17233	57 C	17398	64 C	17565	65 C
16115	138 D	17010	41 C	17103	40 C	17234	57 C	17400	64 C	17566	65 C
16120	138 D	17011	41 C	17104	40 C	17235	58 C	17401	63 C	17567	65 C
16125	138 D	17012	44 C	17105	40 C	17236	58 C	17402	63 C	17568	65 C
16130	140 D	17013	44 C	17108	41 C	17237	58 C	17405	63 C	17569	65 C
16131	138 D	17014	44 C	17109	43 C	17238	56 C	17406	63 C	17570	65 C
16135	140 D	17015	46 C	17110	41 C	17238	85 C	17407	63 C	17571	65 C
16136	139 D	17016	46 C	17111	48 C	17240	59 C	17410	63 C	17572	65 C
16137	139 D	17017	46 C	17112	48 C	17241	59 C	17411	63 C	17573	65 C
16140	140 D	17019	46 C	17116	48 C	17242	59 C	17412	63 C	17574	65 C
16141	143 D	17020	47 C	17117	48 C	17243	59 C	17413	63 C	17575	65 C
16142	139 D	17021	47 C	17121	48 C	17244	59 C	17414	63 C	17576	65 C
16143	139 D	17022	47 C	17122	48 C	17245	56 C	17415	63 C	17577	65 C
16144	139 D	17023	46 C	17125	42 C	17247	85 C	17416	63 C	17578	65 C
16145	139 D	17024	41 C	17126	42 C	17250	55 C	17420	63 C	17579	65 C
16146	140 D	17025	43 C	17127	42 C	17255	55 C	17421	63 C	17580	65 C

number of item	page	number of item	page	number of item	page	number of item	page	number of item	page	number of item	page
17581	65 C	17762	66 C	17902	61 C	18212	71 C	18519	87 C	18750	79 C
17582	65 C	17766	66 C	17904	61 C	18215	71 C	18520	87 C	18751	79 C
17583	65 C	17769	66 C	17905	61 C	18216	71 C	18521	87 C	18753	79 C
17584	65 C	17788	66 C	17907	61 C	18301	75 C	18522	87 C	18755	79 C
17585	65 C	17789	66 C	17910	61 C	18302	75 C	18523	87 C	18760	79 C
17586	65 C	17795	66 C	17912	61 C	18303	75 C	18524	87 C	18761	79 C
17587	65 C	17806	66 C	17913	61 C	18304	75 C	18527	87 C	18762	79 C
17589	65 C	17810	60 C	17914	61 C	18310	71 C	18540	87 C	18763	79 C
17590	65 C	17811	60 C	17916	61 C	18311	71 C	18541	87 C	18764	79 C
17591	65 C	17820	60 C	17921	61 C	18312	71 C	18542	87 C	18765	79 C
17592	65 C	17821	60 C	17922	61 C	18313	71 C	18543	87 C	18766	79 C
17593	65 C	17822	60 C	17924	61 C	18321	71 C	18544	87 C	18767	79 C
17600	69 C	17823	60 C	17925	61 C	18322	71 C	18545	87 C	18768	79 C
17601	69 C	17824	60 C	17926	61 C	18340	73 C	18546	87 C	18769	79 C
17602	69 C	17825	60 C	17927	61 C	18350	72 C	18547	87 C	18770	79 C
17603	69 C	17826	60 C	17930	61 C	18351	72 C	18548	87 C	18771	79 C
17605	66 C	17827	60 C	17931	61 C	18352	72 C	18549	87 C	18772	79 C
17606	66 C	17828	60 C	17932	61 C	18353	72 C	18550	87 C	18775	79 C
17607	66 C	17829	60 C	17933	61 C	18354	72 C	18551	87 C	18776	79 C
17608	66 C	17830	60 C	17934	61 C	18355	72 C	18552	87 C	18777	79 C
17609	66 C	17831	60 C	17935	61 C	18356	72 C	18553	87 C	18795	81 C
17610	66 C	17832	60 C	17943	61 C	18357	72 C	18554	87 C	18796	81 C
17611	66 C	17835	61 C	17944	61 C	18358	72 C	18557	87 C	18797	81 C
17612	66 C	17836	61 C	17970	80 C	18359	72 C	18559	87 C	18798	81 C
17613	66 C	17837	61 C	17971	80 C	18360	72 C	18562	87 C	18799	81 C
17614	66 C	17838	61 C	17972	80 C	18400	75 C	18567	87 C	18800	80 C
17615	66 C	17839	61 C	17973	80 C	18401	75 C	18572	87 C	18801	80 C
17616	66 C	17840	61 C	17974	80 C	18402	73 C	18575	87 C	18802	80 C
17617	66 C	17841	61 C	17975	80 C	18403	73 C	18576	87 C	18803	80 C
17620	68 C	17842	61 C	17976	80 C	18404	73 C	18577	87 C	18804	80 C
17621	68 C	17843	61 C	17980	80 C	18408	77 C	18578	87 C	18805	80 C
17622	65 C	17844	61 C	17981	80 C	18409	77 C	18579	87 C	18806	80 C
17623	65 C	17845	61 C	17982	80 C	18410	74 C	18580	87 C	18807	80 C
17624	65 C	17846	61 C	17983	80 C	18411	74 C	18581	87 C	18810	80 C
17625	65 C	17847	61 C	18062	72 C	18413	74 C	18582	87 C	18811	80 C
17626	65 C	17848	61 C	18063	72 C	18415	77 C	18583	87 C	18812	80 C
17628	65 C	17849	61 C	18064	72 C	18416	77 C	18584	87 C	18813	80 C
17629	65 C	17850	61 C	18065	72 C	18417	77 C	18585	87 C	18814	80 C
17630	65 C	17851	61 C	18066	72 C	18418	75 C	18586	87 C	18815	80 C
17631	65 C	17852	61 C	18067	72 C	18419	77 C	18587	87 C	18816	80 C
17632	65 C	17853	61 C	18070	72 C	18420	77 C	18588	87 C	18817	80 C
17633	65 C	17854	61 C	18071	72 C	18421	84 C	18589	87 C	18820	80 C
17640	68 C	17855	61 C	18072	72 C	18422	73 C	18593	87 C	18821	80 C
17642	68 C	17856	61 C	18075	72 C	18423	74 C	18600	81 C	18822	80 C
17643	68 C	17860	60 C	18076	72 C	18424	73 C	18601	81 C	18823	80 C
17644	68 C	17861	60 C	18077	72 C	18425	76 C	18602	81 C	18824	80 C
17645	68 C	17862	60 C	18080	72 C	18426	74 C	18603	59 C	18825	80 C
17650	68 C	17863	60 C	18081	72 C	18430	84 C	18604	64 C	18826	80 C
17651	68 C	17864	60 C	18082	72 C	18431	77 C	18607	81 C	18827	80 C
17652	68 C	17865	60 C	18083	72 C	18433	76 C	18608	76 C	18828	80 C
17653	68 C	17866	60 C	18084	72 C	18435	76 C	18609	81 C	18829	80 C
17654	68 C	17867	60 C	18085	72 C	18437	74 C	18610	82 C	18830	80 C
17655	68 C	17868	60 C	18086	72 C	18440	84 C	18611	82 C	18831	80 C
17656	68 C	17869	60 C	18087	72 C	18450	76 C	18612	82 C	18832	80 C
17657	68 C	17870	60 C	18088	72 C	18451	76 C	18613	82 C	18835	80 C
17658	68 C	17871	60 C	18089	72 C	18455	72 C	18614	82 C	18836	80 C
17659	68 C	17872	60 C	18090	72 C	18456	72 C	18615	82 C	18837	80 C
17660	65 C	17873	60 C	18091	72 C	18460	72 C	18618	82 C	18838	80 C
17661	65 C	17874	60 C	18092	72 C	18466	87 C	18619	64 C	18839	80 C
17662	65 C	17875	60 C	18101	75 C	18468	87 C	18619	81 C	18840	80 C
17663	65 C	17876	60 C	18102	75 C	18476	87 C	18620	79 C	18841	80 C
17664	65 C	17877	60 C	18103	75 C	18477	87 C	18621	79 C	18842	80 C
17665	65 C	17878	60 C	18104	75 C	18490	86 C	18623	79 C	18843	80 C
17666	65 C	17879	60 C	18105	75 C	18491	86 C	18625	79 C	18844	80 C
17667	65 C	17880	60 C	18106	75 C	18492	86 C	18627	79 C	18845	80 C
17668	65 C	17881	60 C	18107	75 C	18493	86 C	18628	79 C	18846	80 C
17669	65 C	17882	60 C	18108	75 C	18494	88 C	18630	79 C	18847	80 C
17670	65 C	17883	60 C	18110	76 C	18495	88 C	18631	79 C	18850	80 C
17671	65 C	17884	60 C	18113	71 C	18496	86 C	18632	79 C	18851	80 C
17672	65 C	17885	60 C	18114	71 C	18497	86 C	18633	79 C	18852	80 C
17674	65 C	17886	60 C	18115	71 C	18498	86 C	18634	79 C	18853	80 C
17675	65 C	17887	60 C	18116	71 C	18499	88 C	18635	79 C	18855	80 C
17676	65 C	17888	60 C	18118	71 C	18500	86 C	18636	79 C	18856	80 C
17677	65 C	17889	60 C	18120	71 C	18508	87 C	18637	79 C	18860	80 C
17678	65 C	17890	60 C	18124	71 C	18510	87 C	18638	79 C	18861	80 C
17679	65 C	17891	60 C	18125	71 C	18511	87 C	18639	79 C	18862	80 C
17680	68 C	17892	60 C	18201	75 C	18512	87 C	18640	79 C	18863	80 C
17681	68 C	17895	61 C	18202	75 C	18513	87 C	18641	79 C	18864	80 C
17682	68 C	17896	61 C	18203	75 C	18514	87 C	18645	79 C	18865	80 C
17683	65 C	17897	61 C	18204	75 C	18515	87 C	18646	79 C	18866	80 C
17685	66 C	17898	61 C	18210	71 C	18516	87 C	18680	79 C	18867	80 C
17761	66 C	17900	61 C	18211	71 C	18518	87 C	18685	79 C	18868	81 C

LIST OF ITEMS

number of item	page	number of item	page	number of item	page	number of item	page	number of item	page	number of item	page
18869	81 C	19061	90 C	19360	96 C	19481	173 D	19577	158 D	19645	158 D
18870	81 C	19062	91 C	19370	96 C	19482	173 D	19578	158 D	19646	158 D
18871	81 C	19063	91 C	19371	96 C	19483	173 D	19579	158 D	19647	158 D
18872	81 C	19064	90 C	19380	95 C	19485	172 D	19580	158 D	19648	158 D
18873	81 C	19065	91 C	19381	95 C	19486	172 D	19580	158 D	19649	158 D
18874	81 C	19066	90 C	19382	95 C	19487	172 D	19581	158 D	19650	158 D
18900	83 C	19067	90 C	19383	95 C	19490	99 C	19582	158 D	19650	158 D
18901	83 C	19068	90 C	19384	95 C	19491	99 C	19583	158 D	19651	158 D
18905	83 C	19069	90 C	19385	95 C	19492	99 C	19584	158 D	19652	158 D
18906	83 C	19070	90 C	19387	95 C	19493	99 C	19585	158 D	19653	158 D
18907	84 C	19071	90 C	19388	95 C	19494	99 C	19585	158 D	19654	158 D
18909	83 C	19074	89 C	19389	95 C	19495	99 C	19586	158 D	19655	158 D
18910	76 C	19075	89 C	19390	96 C	19496	99 C	19587	158 D	19656	158 D
18915	84 C	19076	89 C	19391	95 C	19497	99 C	19588	158 D	19657	158 D
18916	84 C	19077	89 C	19392	96 C	19498	99 C	19589	158 D	19658	158 D
18920	62 C	19081	89 C	19394	97 C	19499	99 C	19590	158 D	19659	158 D
18921	62 C	19082	89 C	19395	97 C	19501	99 C	19590	158 D	19660	158 D
18922	62 C	19083	89 C	19396	97 C	19502	99 C	19591	158 D	19661	158 D
18925	62 C	19084	89 C	19397	97 C	19510	100 C	19592	158 D	19662	158 D
18926	62 C	19085	89 C	19398	92 C	19515	100 C	19593	158 D	19663	158 D
18927	62 C	19086	89 C	19399	92 C	19520	100 C	19594	158 D	19664	158 D
18928	62 C	19088	89 C	19400	98 C	19530	158 D	19595	158 D	19665	158 D
18929	62 C	19090	89 C	19401	98 C	19530	158 D	19595	158 D	19669	158 D
18930	62 C	19092	89 C	19402	98 C	19531	158 D	19596	158 D	19670	159 D
18931	62 C	19095	89 C	19403	98 C	19532	158 D	19597	158 D	19671	159 D
18934	62 C	19096	89 C	19404	98 C	19533	158 D	19598	158 D	19672	159 D
18935	62 C	19097	89 C	19405	98 C	19534	158 D	19599	158 D	19673	159 D
18937	62 C	19098	89 C	19406	98 C	19535	158 D	19600	158 D	19673	159 D
18939	62 C	19100	91 C	19407	98 C	19535	158 D	19600	158 D	19674	159 D
18944	62 C	19106	89 C	19408	98 C	19536	158 D	19601	158 D	19675	159 D
18945	62 C	19108	89 C	19409	98 C	19537	158 D	19602	158 D	19676	159 D
18948	62 C	19109	89 C	19410	98 C	19538	158 D	19603	158 D	19677	159 D
18950	62 C	19110	100 C	19410	172 D	19539	158 D	19604	158 D	19678	159 D
18951	62 C	19115	92 C	19411	98 C	19540	158 D	19605	158 D	19678	159 D
18954	62 C	19115	116 C	19411	172 D	19540	158 D	19605	158 D	19679	159 D
18955	62 C	19124	92 C	19412	98 C	19541	158 D	19606	158 D	19680	159 D
18956	62 C	19136	92 C	19412	172 D	19542	158 D	19607	158 D	19681	159 D
18957	62 C	19148	92 C	19415	97 C	19543	158 D	19608	158 D	19682	159 D
18960	62 C	19149	92 C	19416	97 C	19544	158 D	19609	158 D	19683	159 D
18961	62 C	19150	91 C	19418	98 C	19545	158 D	19610	158 D	19683	159 D
18963	62 C	19151	90 C	19418	172 D	19545	158 D	19610	158 D	19684	159 D
18967	62 C	19200	93 C	19419	98 C	19546	158 D	19611	158 D	19685	159 D
18968	62 C	19202	93 C	19419	172 D	19547	158 D	19612	158 D	19686	159 D
18969	62 C	19208	94 C	19421	97 C	19548	158 D	19613	158 D	19687	159 D
18970	62 C	19209	94 C	19422	97 C	19549	158 D	19614	158 D	19688	159 D
18971	62 C	19211	94 C	19423	97 C	19550	158 D	19615	158 D	19688	159 D
18972	62 C	19245	93 C	19424	97 C	19550	158 D	19615	158 D	19689	159 D
18993	82 C	19246	93 C	19425	97 C	19551	158 D	19616	158 D	19690	159 D
18994	82 C	19247	93 C	19426	97 C	19552	158 D	19617	158 D	19691	159 D
19001	90 C	19248	93 C	19427	97 C	19552	158 D	19618	158 D	19692	159 D
19002	90 C	19249	93 C	19429	172 D	19553	158 D	19619	158 D	19693	159 D
19003	90 C	19251	94 C	19430	92 C	19554	158 D	19620	158 D	19693	159 D
19004	90 C	19252	94 C	19431	92 C	19555	158 D	19620	158 D	19694	159 D
19005	90 C	19253	94 C	19432	92 C	19555	158 D	19621	158 D	19695	159 D
19006	90 C	19254	93 C	19433	92 C	19556	158 D	19622	158 D	19695	159 D
19008	90 C	19255	93 C	19434	92 C	19557	158 D	19623	158 D	19696	159 D
19010	90 C	19265	93 C	19435	92 C	19558	158 D	19624	158 D	19697	159 D
19015	90 C	19270	93 C	19436	98 C	19558	158 D	19625	158 D	19698	159 D
19020	90 C	19271	93 C	19436	172 D	19559	158 D	19625	158 D	19698	159 D
19021	90 C	19272	93 C	19440	92 C	19560	158 D	19626	158 D	19699	159 D
19022	90 C	19290	93 C	19441	92 C	19560	158 D	19627	158 D	19700	159 D
19023	90 C	19294	93 C	19442	92 C	19561	158 D	19628	158 D	19701	159 D
19024	90 C	19295	93 C	19443	92 C	19562	158 D	19629	158 D	19701	159 D
19025	90 C	19297	94 C	19450	99 C	19562	158 D	19630	158 D	19702	159 D
19026	90 C	19301	96 C	19451	99 C	19563	158 D	19630	158 D	19703	159 D
19028	90 C	19303	91 C	19455	99 C	19564	158 D	19631	158 D	19703	159 D
19030	90 C	19306	95 C	19457	99 C	19565	158 D	19632	158 D	19704	159 D
19031	90 C	19308	95 C	19458	100 C	19565	158 D	19633	158 D	19705	159 D
19032	90 C	19310	95 C	19459	100 C	19566	158 D	19634	158 D	19705	159 D
19034	90 C	19312	95 C	19460	98 C	19567	158 D	19635	158 D	19706	159 D
19036	90 C	19314	95 C	19462	97 C	19568	158 D	19635	158 D	19707	159 D
19050	90 C	19326	96 C	19463	97 C	19568	158 D	19636	158 D	19708	159 D
19051	91 C	19328	96 C	19464	97 C	19569	158 D	19637	158 D	19708	159 D
19052	91 C	19330	96 C	19465	97 C	19570	158 D	19638	158 D	19709	159 D
19053	90 C	19332	96 C	19469	97 C	19570	158 D	19639	158 D	19710	159 D
19054	90 C	19335	96 C	19470	98 C	19571	158 D	19640	158 D	19711	159 D
19055	90 C	19337	96 C	19472	173 D	19572	158 D	19640	158 D	19711	159 D
19056	90 C	19340	95 C	19473	173 D	19573	158 D	19641	158 D	19712	159 D
19057	90 C	19344	96 C	19474	173 D	19574	158 D	19642	158 D	19713	159 D
19058	90 C	19354	96 C	19477	173 D	19575	158 D	19643	158 D	19713	159 D
19059	90 C	19356	96 C	19478	173 D	19575	158 D	19644	158 D	19714	159 D
19060	91 C	19357	96 C	19480	173 D	19576	158 D	19645	158 D	19715	159 D

number of item	page	number of item	page	number of item	page	number of item	page	number of item	page	number of item	page
19716	159 D	19783	159 D	20411	160 D	20740	174 D	20905	174 D	21211	203 D
19717	159 D	19784	159 D	20412	160 D	20741	174 D	20910	174 D	21212	203 D
19718	159 D	19785	159 D	20413	160 D	20744	168 D	20911	174 D	21215	203 D
19718	159 D	19786	159 D	20414	160 D	20744	178 D	20912	174 D	21218	203 D
19719	159 D	19786	159 D	20415	160 D	20745	178 D	20913	174 D	21219	203 D
19720	159 D	19787	159 D	20416	160 D	20748	166 D	20915	174 D	21220	203 D
19721	159 D	19788	159 D	20417	160 D	20749	166 D	20916	174 D	21223	203 D
19722	159 D	19789	159 D	20418	160 D	20750	166 D	20917	174 D	21224	203 D
19723	159 D	19790	159 D	20419	160 D	20751	166 D	20918	174 D	21301	205 D
19723	159 D	19791	159 D	20420	160 D	20752	166 D	20919	174 D	21303	205 D
19724	159 D	19792	159 D	20421	160 D	20753	166 D	20920	174 D	21306	207 D
19725	159 D	19793	159 D	20422	160 D	20754	166 D	20921	174 D	21308	207 D
19726	159 D	19794	159 D	20423	160 D	20755	166 D	20922	174 D	21311	203 D
19727	159 D	19795	159 D	20424	160 D	20756	166 D	20923	174 D	21312	203 D
19728	159 D	19796	159 D	20425	160 D	20757	166 D	20924	174 D	21315	203 D
19728	159 D	19797	159 D	20426	160 D	20758	166 D	20936	168 D	21318	203 D
19729	159 D	19798	159 D	20427	160 D	20759	166 D	20937	168 D	21323	203 D
19730	159 D	19799	159 D	20428	160 D	20760	166 D	20938	168 D	21324	203 D
19731	159 D	19800	159 D	20429	160 D	20761	166 D	20939	168 D	21325	203 D
19732	159 D	19801	159 D	20430	160 D	20762	166 D	20940	168 D	21326	203 D
19733	159 D	19802	159 D	20450	175 D	20764	166 D	20941	168 D	21410	204 D
19733	159 D	19841	160 D	20460	175 D	20765	166 D	20942	168 D	21411	204 D
19734	159 D	19842	160 D	20487	163 D	20766	166 D	20943	168 D	21412	204 D
19735	159 D	19845	160 D	20488	163 D	20767	166 D	20944	168 D	21415	204 D
19736	159 D	19885	160 D	20489	163 D	20768	166 D	20945	168 D	21418	204 D
19737	159 D	19895	160 D	20490	163 D	20769	166 D	20946	168 D	21423	204 D
19738	159 D	20210	175 D	20491	163 D	20770	166 D	20947	168 D	21424	204 D
19738	159 D	20220	160 D	20492	163 D	20771	166 D	20948	168 D	21425	205 D
19739	159 D	20225	160 D	20493	163 D	20772	166 D	20949	168 D	21426	205 D
19740	159 D	20230	160 D	20494	163 D	20773	166 D	20950	167 D	21427	205 D
19741	159 D	20235	160 D	20495	163 D	20774	166 D	20952	167 D	21428	205 D
19742	159 D	20240	160 D	20496	163 D	20775	166 D	20954	168 D	21430	205 D
19743	159 D	20245	160 D	20510	167 D	20776	166 D	20956	168 D	21431	205 D
19743	159 D	20250	160 D	20511	167 D	20777	166 D	20957	174 D	21432	205 D
19744	159 D	20255	160 D	20512	167 D	20778	166 D	20958	174 D	21440	174 D
19745	159 D	20260	160 D	20513	167 D	20779	166 D	20960	178 D	21441	174 D
19746	159 D	20270	160 D	20514	167 D	20780	166 D	20961	178 D	21442	174 D
19747	159 D	20280	160 D	20515	167 D	20781	166 D	20963	178 D	21443	174 D
19748	159 D	20290	160 D	20516	167 D	20782	166 D	20965	178 D	21444	174 D
19748	159 D	20296	160 D	20520	167 D	20783	166 D	20966	178 D	21445	174 D
19749	159 D	20300	162 D	20521	167 D	20784	166 D	20967	68 C	21446	174 D
19750	159 D	20305	162 D	20522	167 D	20785	166 D	20968	68 C	21450	175 D
19751	159 D	20310	162 D	20523	167 D	20786	166 D	20969	68 C	21451	175 D
19752	159 D	20311	162 D	20524	167 D	20787	166 D	20970	178 D	21452	175 D
19753	159 D	20315	162 D	20525	167 D	20788	166 D	20971	178 D	21453	176 D
19753	159 D	20316	161 D	20526	167 D	20789	166 D	20972	178 D	21454	176 D
19754	159 D	20317	161 D	20673	166 D	20790	166 D	20973	178 D	21530	175 D
19755	159 D	20320	162 D	20674	166 D	20791	166 D	20980	174 D	21540	176 D
19756	159 D	20321	162 D	20675	166 D	20792	166 D	20981	174 D	21541	176 D
19757	159 D	20333	161 D	20676	166 D	20793	166 D	20982	174 D	21701	186 D
19758	159 D	20334	161 D	20677	166 D	20794	166 D	20983	174 D	21702	186 D
19758	159 D	20335	161 D	20678	166 D	20795	166 D	20984	174 D	21703	186 D
19759	159 D	20336	161 D	20680	166 D	20796	166 D	20990	168 D	21704	186 D
19760	159 D	20337	161 D	20682	166 D	20797	166 D	20991	168 D	21705	186 D
19761	159 D	20338	161 D	20684	166 D	20798	166 D	20992	168 D	21706	186 D
19762	159 D	20350	173 D	20685	166 D	20799	166 D	20999	167 D	21709	186 D
19763	159 D	20360	154 D	20686	166 D	20805	167 D	21010	204 D	21715	186 D
19763	159 D	20361	154 D	20687	166 D	20820	167 D	21011	204 D	21716	186 D
19764	159 D	20363	49 C	20688	166 D	20825	166 D	21012	204 D	21717	186 D
19765	159 D	20365	178 D	20690	166 D	20855	166 D	21015	204 D	21718	186 D
19766	159 D	20379	170 D	20691	166 D	20861	166 D	21018	204 D	21719	186 D
19767	159 D	20380	162 D	20692	166 D	20862	166 D	21023	204 D	21720	186 D
19768	159 D	20381	177 D	20694	166 D	20870	166 D	21110	204 D	21721	186 D
19768	159 D	20385	165 D	20696	166 D	20871	166 D	21111	204 D	21724	186 D
19769	159 D	20386	165 D	20697	166 D	20872	166 D	21112	204 D	21732	186 D
19770	159 D	20387	165 D	20698	166 D	20873	166 D	21115	204 D	21734	186 D
19771	159 D	20390	165 D	20724	174 D	20874	166 D	21118	204 D	21735	186 D
19772	159 D	20391	165 D	20725	174 D	20875	166 D	21123	204 D	21736	186 D
19772	159 D	20395	165 D	20726	174 D	20876	166 D	21130	204 D	21737	186 D
19773	159 D	20396	165 D	20727	174 D	20877	166 D	21135	204 D	21740	186 D
19774	159 D	20397	165 D	20728	174 D	20878	166 D	21140	204 D	21741	186 D
19775	159 D	20400	160 D	20729	174 D	20879	166 D	21150	204 D	21742	186 D
19776	159 D	20401	160 D	20730	174 D	20880	166 D	21180	204 D	21743	186 D
19776	159 D	20402	160 D	20731	174 D	20881	166 D	21190	204 D	21744	186 D
19777	159 D	20403	160 D	20732	174 D	20890	167 D	21192	207 D	21750	186 D
19778	159 D	20404	160 D	20733	174 D	20891	167 D	21194	207 D	21751	186 D
19779	159 D	20405	160 D	20734	174 D	20895	167 D	21195	205 D	21752	186 D
19780	159 D	20406	160 D	20735	174 D	20896	174 D	21200	203 D	21753	186 D
19781	159 D	20407	160 D	20736	174 D	20897	174 D	21201	203 D	21754	186 D
19781	159 D	20408	160 D	20737	174 D	20898	174 D	21203	203 D	21780	208 D
19782	159 D	20409	160 D	20738	174 D	20899	174 D	21204	203 D	21781	208 D
19783	159 D	20410	160 D	20739	174 D	20901	175 D	21210	203 D	21782	208 D

LIST OF ITEMS

number of item	page	number of item	page	number of item	page	number of item	page	number of item	page	number of item	page
21783	208 D	22018	181 D	22102	187 D	22207	189 D	22515	157 D	23291	363 G
21784	208 D	22019	181 D	22103	187 D	22208	189 D	22520	157 D	23292	363 G
21786	208 D	22020	181 D	22104	187 D	22209	189 D	22525	157 D	23296	363 G
21787	208 D	22021	181 D	22105	187 D	22211	206 D	22530	157 D	23297	363 G
21788	208 D	22022	181 D	22106	187 D	22212	206 D	22532	157 D	23310	361 G
21789	208 D	22023	180 D	22107	187 D	22215	206 D	22535	157 D	23311	361 G
21790	208 D	22024	180 D	22108	187 D	22216	206 D	22540	157 D	23312	361 G
21792	208 D	22025	180 D	22109	187 D	22217	206 D	22542	157 D	23390	363 G
21793	208 D	22026	181 D	22110	187 D	22218	206 D	22545	157 D	23391	363 G
21794	208 D	22027	181 D	22111	187 D	22219	206 D	22548	157 D	23400	109 C
21795	208 D	22028	181 D	22112	187 D	22220	206 D	22550	157 D	23401	109 C
21796	208 D	22029	181 D	22113	187 D	22222	206 D	22555	157 D	23402	109 C
21798	184 D	22030	181 D	22115	187 D	22224	206 D	22560	157 D	23406	109 C
21798	208 D	22031	181 D	22116	187 D	22225	206 D	22565	157 D	23407	109 C
21800	209 D	22032	181 D	22117	187 D	22230	207 D	22568	157 D	23410	108 C
21801	209 D	22033	182 D	22120	188 D	22232	207 D	22570	157 D	23411	108 C
21802	209 D	22034	182 D	22121	188 D	22234	207 D	22575	157 D	23412	108 C
21810	185 D	22035	182 D	22122	188 D	22236	207 D	22580	157 D	23415	108 C
21811	185 D	22036	182 D	22123	188 D	22238	207 D	22585	157 D	23416	108 C
21812	185 D	22037	180 D	22124	188 D	22240	206 D	22590	157 D	23417	108 C
21813	185 D	22038	180 D	22125	188 D	22242	206 D	22595	157 D	23420	109 C
21814	185 D	22039	180 D	22126	188 D	22244	206 D	22600	157 D	23506	108 C
21831	185 D	22040	180 D	22129	188 D	22246	206 D	22602	157 D	23507	108 C
21832	185 D	22041	183 D	22130	188 D	22248	206 D	22605	157 D	23508	108 C
21834	185 D	22042	183 D	22132	188 D	22251	206 D	22610	157 D	23515	108 C
21850	187 D	22043	183 D	22133	188 D	22252	206 D	22615	157 D	23520	108 C
21851	187 D	22044	183 D	22134	188 D	22253	206 D	22620	157 D	23525	108 C
21852	187 D	22045	185 D	22135	343 F	22254	206 D	22625	157 D	23530	108 C
21853	187 D	22046	185 D	22136	343 F	22255	206 D	22630	157 D	23531	108 C
21854	187 D	22047	185 D	22137	343 F	22258	206 D	22701	183 D	23551	108 C
21855	187 D	22048	185 D	22138	343 F	22259	206 D	22702	183 D	23560	107 C
21856	187 D	22049	185 D	22140	208 D	22263	206 D	22703	183 D	23561	107 C
21857	187 D	22050	185 D	22141	208 D	22264	206 D	22704	183 D	23562	107 C
21858	187 D	22051	185 D	22142	208 D	22266	206 D	22705	183 D	23563	107 C
21859	187 D	22052	185 D	22143	208 D	22270	206 D	22706	183 D	23564	107 C
21860	187 D	22053	185 D	22145	208 D	22273	206 D	22707	183 D	23565	107 C
21861	187 D	22054	185 D	22146	208 D	22274	206 D	23000	360 G	23566	107 C
21862	187 D	22055	185 D	22147	208 D	22275	206 D	23001	360 G	23570	107 C
21863	187 D	22056	185 D	22148	208 D	22277	206 D	23005	362 G	23571	107 C
21864	187 D	22057	185 D	22150	208 D	22280	206 D	23006	362 G	23572	107 C
21900	179 D	22058	181 D	22151	208 D	22281	206 D	23010	362 G	23573	107 C
21901	179 D	22059	181 D	22155	208 D	22285	206 D	23020	362 G	23574	107 C
21902	179 D	22060	183 D	22156	208 D	22286	206 D	23025	362 G	23585	108 C
21903	179 D	22061	183 D	22158	182 D	22294	207 D	23030	362 G	23587	108 C
21904	179 D	22062	183 D	22159	182 D	22300	191 D	23035	362 G	23589	108 C
21905	179 D	22063	183 D	22160	185 D	22301	191 D	23040	362 G	23591	108 C
21906	179 D	22064	183 D	22161	185 D	22302	191 D	23050	362 G	23600	108 C
21907	180 D	22065	184 D	22162	185 D	22303	191 D	23060	362 G	23601	108 C
21908	180 D	22066	184 D	22163	185 D	22305	191 D	23070	362 G	23602	108 C
21909	180 D	22067	186 D	22164	185 D	22307	191 D	23125	361 G	23605	108 C
21910	180 D	22068	184 D	22165	185 D	22309	191 D	23130	361 G	23620	108 C
21911	180 D	22069	184 D	22166	185 D	22310	191 D	23135	361 G	23625	108 C
21912	180 D	22070	184 D	22167	185 D	22311	191 D	23140	361 G	23626	108 C
21913	180 D	22071	184 D	22168	185 D	22312	191 D	23150	361 G	23628	108 C
21914	180 D	22072	184 D	22169	185 D	22313	191 D	23160	361 G	23630	108 C
21920	179 D	22073	183 D	22170	190 D	22314	191 D	23211	361 G	23632	108 C
21925	179 D	22074	183 D	22171	190 D	22315	191 D	23212	361 G	23650	109 C
21926	179 D	22075	186 D	22172	190 D	22317	191 D	23213	361 G	23660	109 C
21930	181 D	22076	186 D	22173	190 D	22318	191 D	23214	361 G	23670	107 C
21931	181 D	22077	186 D	22174	190 D	22319	191 D	23215	361 G	23671	107 C
21935	181 D	22078	182 D	22178	189 D	22320	191 D	23220	361 G	23672	107 C
21936	181 D	22079	182 D	22180	189 D	22322	191 D	23225	361 G	23673	107 C
21937	181 D	22080	182 D	22181	189 D	22324	191 D	23232	361 G	23674	107 C
21940	181 D	22081	182 D	22182	189 D	22326	191 D	23240	361 G	23675	107 C
21941	181 D	22082	182 D	22183	189 D	22328	191 D	23250	361 G	23676	107 C
22001	179 D	22083	184 D	22184	189 D	22329	191 D	23260	361 G	23677	107 C
22002	179 D	22084	184 D	22185	189 D	22332	191 D	23261	361 G	23678	107 C
22003	179 D	22085	184 D	22186	189 D	22333	191 D	23262	361 G	23679	107 C
22004	180 D	22086	182 D	22188	190 D	22335	191 D	23263	361 G	23680	107 C
22005	180 D	22087	183 D	22189	190 D	22337	191 D	23264	361 G	23681	107 C
22006	180 D	22088	184 D	22190	190 D	22340	191 D	23265	361 G	23682	107 C
22007	179 D	22090	184 D	22195	190 D	22343	191 D	23266	361 G	23683	107 C
22008	179 D	22091	184 D	22197	190 D	22345	191 D	23270	360 G	23684	107 C
22009	179 D	22092	184 D	22198	190 D	22350	191 D	23273	361 G	23685	107 C
22010	179 D	22093	184 D	22199	190 D	22351	191 D	23274	361 G	23730	113 C
22011	179 D	22095	184 D	22200	170 D	22355	191 D	23275	361 G	23730	401 H
22012	180 D	22096	185 D	22201	170 D	22357	191 D	23281	363 G	23731	113 C
22013	180 D	22097	185 D	22202	190 D	22365	191 D	23282	363 G	23731	401 H
22014	180 D	22098	185 D	22203	190 D	22370	191 D	23284	363 G	23732	113 C
22015	180 D	22099	185 D	22204	190 D	22398	191 D	23287	362 G	23732	401 H
22016	180 D	22100	187 D	22205	190 D	22399	191 D	23288	362 G	23734	113 C
22017	180 D	22101	187 D	22206	189 D	22510	157 D	23290	363 G	23734	401 H

number of item	page	number of item	page	number of item	page	number of item	page	number of item	page	number of item	page
23735	113 C	23987	112 C	24144	199 D	24511	103 C	24731	168 D	25170	285 E
23735	401 H	23988	112 C	24145	199 D	24515	103 C	24732	168 D	25171	285 E
23736	113 C	23989	112 C	24147	199 D	24516	103 C	24735	170 D	25179	284 E
23736	401 H	24000	111 C	24148	199 D	24517	103 C	24736	170 D	25180	284 E
23760	102 C	24001	111 C	24149	199 D	24518	104 C	24737	170 D	25181	284 E
23761	102 C	24002	111 C	24150	200 D	24519	104 C	24738	170 D	25182	284 E
23762	102 C	24005	111 C	24151	200 D	24520	103 C	24739	170 D	25183	284 E
23763	102 C	24006	111 C	24152	201 D	24521	104 C	24740	170 D	25184	284 E
23764	102 C	24007	110 C	24152	301 F	24522	104 C	24741	170 D	25186	284 E
23800	102 C	24010	110 C	24153	197 D	24530	105 C	24743	170 D	25188	284 E
23810	370 G	24015	111 C	24154	200 D	24531	105 C	24745	169 D	25189	284 E
23814	370 G	24017	111 C	24155	202 D	24532	105 C	24746	170 D	25190	284 E
23816	370 G	24020	111 C	24156	202 D	24533	105 C	24747	169 D	25195	284 E
23818	370 G	24030	111 C	24158	202 D	24534	105 C	24748	170 D	25206	284 E
23820	370 G	24035	112 C	24159	188 D	24535	105 C	24749	170 D	25212	284 E
23824	370 G	24036	112 C	24159	202 D	24536	105 C	24750	164 D	25215	284 E
23826	370 G	24038	112 C	24160	196 D	24537	105 C	24751	164 D	25220	284 E
23828	370 G	24039	112 C	24161	196 D	24538	105 C	24755	176 D	25224	284 E
23830	370 G	24040	112 C	24162	196 D	24539	105 C	24756	176 D	25230	284 E
23840	307 F	24041	112 C	24163	196 D	24540	105 C	24757	169 D	25240	284 E
23845	306 F	24042	112 C	24164	196 D	24541	105 C	24758	169 D	25248	284 E
23846	306 F	24043	112 C	24165	196 D	24542	105 C	24759	169 D	25260	284 E
23847	306 F	24045	193 D	24166	196 D	24543	105 C	24760	171 D	25296	284 E
23850	370 G	24050	195 D	24167	196 D	24545	105 C	24761	171 D	25350	284 E
23854	370 G	24055	192 D	24168	196 D	24546	105 C	24762	171 D	25365	285 E
23856	370 G	24055	249 E	24169	196 D	24547	105 C	24763	171 D	25366	285 E
23858	370 G	24060	192 D	24170	198 D	24550	105 C	24764	171 D	25367	285 E
23860	370 G	24061	192 D	24171	199 D	24551	105 C	24765	171 D	25368	285 E
23864	370 G	24062	192 D	24173	200 D	24552	105 C	24766	171 D	25369	284 E
23865	370 G	24063	192 D	24174	202 D	24553	105 C	24767	171 D	25370	284 E
23866	370 G	24064	192 D	24175	202 D	24555	105 C	24768	171 D	25371	284 E
23868	370 G	24065	192 D	24176	202 D	24556	105 C	24769	171 D	25372	284 E
23870	370 G	24066	192 D	24177	202 D	24557	105 C	24770	170 D	25373	284 E
23880	370 G	24067	192 D	24178	202 D	24558	105 C	24771	170 D	25374	284 E
23882	370 G	24068	192 D	24180	197 D	24560	105 C	24772	170 D	25376	284 E
23884	370 G	24069	192 D	24181	202 D	24561	105 C	24773	170 D	25378	284 E
23904	102 C	24070	192 D	24185	196 D	24562	105 C	24774	170 D	25379	284 E
23906	102 C	24071	192 D	24186	196 D	24565	106 C	24780	171 D	25380	284 E
23908	102 C	24072	192 D	24187	196 D	24567	105 C	24781	171 D	25400	285 E
23910	102 C	24073	192 D	24188	196 D	24568	105 C	24782	171 D	25410	285 E
23912	102 C	24074	192 D	24189	196 D	24569	105 C	24783	171 D	26021	31 B
23914	102 C	24075	192 D	24190	188 D	24570	106 C	24784	171 D	26021	123 C
23920	102 C	24076	192 D	24190	202 D	24571	106 C	24785	171 D	26028	22 B
23922	102 C	24077	192 D	24192	196 D	24572	106 C	24786	171 D	26037	29 B
23923	101 C	24078	192 D	24195	196 D	24573	106 C	24787	171 D	26205	22 B
23924	101 C	24080	193 D	24196	196 D	24574	106 C	24788	171 D	26215	21 B
23925	101 C	24081	193 D	24197	196 D	24575	106 C	24789	171 D	26216	21 B
23927	101 C	24082	193 D	24212	374 G	24577	106 C	24790	171 D	26217	21 B
23928	102 C	24083	193 D	24225	374 G	24578	106 C	24791	171 D	26218	21 B
23930	106 C	24084	193 D	24250	374 G	24580	105 C	24792	171 D	26260	26 B
23931	106 C	24085	193 D	24255	374 G	24581	105 C	24793	171 D	26343	25 B
23932	106 C	24086	193 D	24258	374 G	24582	105 C	24794	171 D	26395	29 B
23934	106 C	24087	193 D	24260	374 G	24583	105 C	24795	171 D	26429	27 B
23935	106 C	24098	193 D	24301	194 D	24584	105 C	24796	171 D	26430	27 B
23936	106 C	24099	193 D	24302	194 D	24690	178 D	24798	171 D	26431	27 B
23945	101 C	24100	197 D	24303	194 D	24691	178 D	25001	285 E	26440	30 B
23950	112 C	24102	197 D	24304	194 D	24695	178 D	25002	285 E	26441	30 B
23951	112 C	24103	197 D	24305	194 D	24700	171 D	25003	285 E	26460	23 B
23952	112 C	24104	197 D	24306	194 D	24701	171 D	25004	285 E	26464	23 B
23953	112 C	24108	196 D	24308	195 D	24702	171 D	25005	285 E	26479	25 B
23954	112 C	24109	197 D	24310	195 D	24703	171 D	25006	284 E	26493	31 B
23955	112 C	24110	198 D	24312	195 D	24704	171 D	25009	284 E	26495	31 B
23960	102 C	24111	198 D	24313	195 D	24705	171 D	25012	284 E	26520	24 B
23961	102 C	24118	197 D	24314	196 D	24706	177 D	25015	284 E	26521	24 B
23962	102 C	24119	197 D	24315	195 D	24712	177 D	25016	284 E	26523	28 B
23963	102 C	24120	196 D	24410	164 D	24713	177 D	25020	284 E	26524	29 B
23964	102 C	24121	198 D	24411	164 D	24714	177 D	25024	284 E	26526	30 B
23965	102 C	24122	198 D	24419	164 D	24715	177 D	25025	284 E	26527	23 B
23966	102 C	24124	198 D	24420	164 D	24716	177 D	25030	284 E	26528	26 B
23967	102 C	24125	198 D	24422	164 D	24717	169 D	25040	284 E	26700	398 H
23970	112 C	24126	198 D	24425	164 D	24718	169 D	25048	284 E	26701	398 H
23971	112 C	24128	200 D	24429	164 D	24719	169 D	25060	284 E	26702	398 H
23972	112 C	24130	199 D	24432	164 D	24720	177 D	25096	284 E	26705	288 E
23973	112 C	24131	199 D	24435	164 D	24721	177 D	25150	284 E	26705	398 H
23974	112 C	24133	199 D	24437	164 D	24722	177 D	25153	284 E	26706	288 E
23975	112 C	24135	200 D	24444	164 D	24723	169 D	25155	284 E	26706	398 H
23976	112 C	24136	200 D	24451	164 D	24725	169 D	25160	285 E	26707	288 E
23977	112 C	24137	200 D	24457	164 D	24726	169 D	25162	285 E	26707	398 H
23978	112 C	24140	200 D	24464	164 D	24727	259 E	25163	285 E	26720	288 E
23979	112 C	24141	200 D	24476	164 D	24728	259 E	25164	285 E	26720	398 H
23985	112 C	24142	200 D	24483	164 D	24729	259 E	25167	285 E	26721	288 E
23986	112 C	24143	199 D	24510	103 C	24730	168 D	25169	285 E	26721	398 H

LIST OF ITEMS

number of item	page	number of item	page	number of item	page	number of item	page	number of item	page	number of item	page
26722	288 E	31008	213 E	31501	218 E	32226	220 E	33201	389 G	34154	226 E
26722	398 H	31009	213 E	31502	218 E	32234	220 E	33202	389 G	34155	226 E
26775	260 E	31011	213 E	31503	218 E	32240	220 E	33202	389 G	34156	226 E
26780	267 E	31021	213 E	31505	217 E	32265	233 E	33203	389 G	34157	226 E
26781	267 E	31031	213 E	31506	217 E	32268	233 E	33203	389 G	34158	226 E
26782	267 E	31041	213 E	31507	217 E	32269	233 E	33205	389 G	34159	226 E
26783	267 E	31051	213 E	31510	216 E	32270	233 E	33205	389 G	34160	226 E
26800	394 H	31052	214 E	31511	216 E	32273	233 E	33206	389 G	34167	232 E
26801	394 H	31053	213 E	31512	216 E	32283	233 E	33206	389 G	34168	232 E
26802	394 H	31061	214 E	31513	216 E	32285	233 E	33207	389 G	34200	226 E
26803	394 H	31062	214 E	31514	216 E	32293	233 E	33207	389 G	34201	226 E
26804	394 H	31071	214 E	31515	216 E	32295	233 E	33208	389 G	34202	226 E
26805	394 H	31072	214 E	31520	217 E	32296	233 E	33208	389 G	34203	226 E
26806	394 H	31081	214 E	31521	217 E	32297	233 E	33209	389 G	34202	226 E
26807	394 H	31082	213 E	31522	217 E	32298	233 E	33209	389 G	34221	228 E
26815	394 H	31091	212 E	31523	217 E	32301	233 E	33210	389 G	34222	231 E
26816	394 H	31101	212 E	31524	217 E	32302	233 E	33210	389 G	34223	228 E
26817	394 H	31111	212 E	31525	217 E	32312	222 E	33211	389 G	34224	229 E
26819	394 H	31121	212 E	31526	217 E	32313	233 E	33211	389 G	34225	229 E
26820	395 H	31131	212 E	31527	217 E	32314	223 E	33212	389 G	34226	229 E
26824	395 H	31132	212 E	31541	217 E	32315	224 E	33212	389 G	34227	228 E
26825	395 H	31140	212 E	31551	217 E	32316	224 E	33215	389 G	34228	228 E
26826	395 H	31141	212 E	31552	218 E	32317	222 E	33215	389 G	34228	228 E
26829	396 H	31142	212 E	31553	218 E	32317	222 E	33215	389 G	34231	231 E
26840	395 H	31143	212 E	31555	217 E	32318	223 E	33220	390 G	34232	231 E
26844	394 H	31144	212 E	31556	217 E	32319	223 E	33220	390 G	34233	230 E
26845	394 H	31145	212 E	31557	217 E	32320	223 E	33221	390 G	34235	231 E
26853	396 H	31146	212 E	31558	217 E	32321	223 E	33221	390 G	34236	230 E
26857	396 H	31148	212 E	31559	217 E	32322	223 E	33246	391 G	34237	231 E
26858	396 H	31150	213 E	31601	221 E	32323	223 E	33247	391 G	34238	230 E
26859	396 H	31151	213 E	31602	221 E	32324	223 E	33248	391 G	34241	228 E
26862	396 H	31155	213 E	31603	221 E	32325	224 E	33249	391 G	34243	228 E
26871	397 H	31218	216 E	31641	221 E	32326	224 E	33250	390 G	34251	229 E
26880	397 H	31220	214 E	31651	221 E	32327	222 E	33250	390 G	34253	229 E
26881	397 H	31221	214 E	31655	221 E	32328	224 E	33252	390 G	34261	229 E
26886	397 H	31222	214 E	32001	219 E	32328	388 G	33252	390 G	34262	228 E
26888	397 H	31231	214 E	32002	219 E	32329	223 E	33254	390 G	34264	230 E
26891	401 H	31232	214 E	32003	219 E	32330	223 E	33254	390 G	34265	230 E
26895	399 H	31233	214 E	32013	219 E	32331	223 E	33255	390 G	34266	231 E
26896	399 H	31234	214 E	32014	219 E	32335	224 E	33255	390 G	34267	231 E
26897	399 H	31235	214 E	32015	219 E	32337	222 E	33256	390 G	34271	226 E
26911	400 H	31270	215 E	32016	219 E	32418	223 E	33256	390 G	34272	226 E
26912	400 H	31271	215 E	32018	219 E	32421	223 E	33257	390 G	34273	226 E
26914	400 H	31280	215 E	32020	219 E	33100	386 G	33257	390 G	34274	226 E
26915	400 H	31281	215 E	32021	219 E	33102	386 G	33258	390 G	34275	226 E
26920	398 H	31320	215 E	32022	221 E	33105	386 G	33258	390 G	34276	226 E
26921	398 H	31322	215 E	32023	221 E	33107	386 G	33270	391 G	34280	226 E
26922	398 H	31330	215 E	32024	219 E	33110	386 G	33275	267 E	34281	226 E
26934	403 H	31332	215 E	32026	219 E	33112	386 G	33275	391 G	34282	226 E
26936	403 H	31334	214 E	32037	221 E	33113	386 G	33280	391 G	34283	226 E
26938	403 H	31340	215 E	32040	221 E	33114	386 G	33285	391 G	34284	226 E
26940	399 H	31341	215 E	32041	221 E	33120	386 G	33286	391 G	34285	226 E
26941	399 H	31343	214 E	32042	221 E	33123	386 G	33289	391 G	34290	228 E
26943	399 H	31343	214 E	32043	221 E	33124	386 G	33291	391 G	34291	228 E
26953	400 H	31360	214 E	32044	221 E	33127	387 G	33292	391 G	34292	228 E
26954	400 H	31362	214 E	32050	221 E	33127	387 G	33293	391 G	34295	229 E
26961	400 H	31380	214 E	32051	221 E	33131	387 G	33298	391 G	34296	229 E
26963	400 H	31382	214 E	32052	221 E	33132	387 G	33299	391 G	34298	230 E
26966	401 H	31390	214 E	32053	221 E	33135	387 G	34005	225 E	34299	230 E
26972	401 H	31392	214 E	32060	219 E	33137	387 G	34006	225 E	34300	260 E
26973	401 H	31400	214 E	32062	219 E	33140	387 G	34007	225 E	34301	226 E
26974	401 H	31402	214 E	32066	219 E	33141	387 G	34027	224 E	34303	260 E
26975	401 H	31403	214 E	32066	219 E	33143	387 G	34033	232 E	34304	226 E
26976	401 H	31404	214 E	32076	219 E	33150	387 G	34041	225 E	34305	218 E
26977	401 H	31452	218 E	32161	220 E	33151	387 G	34051	225 E	34306	218 E
26979	403 H	31453	218 E	32162	220 E	33152	387 G	34053	225 E	34307	218 E
26985	402 H	31454	218 E	32163	220 E	33154	387 G	34061	226 E	34308	218 E
26986	402 H	31455	216 E	32164	220 E	33155	390 G	34071	226 E	34315	188 D
26988	403 H	31456	216 E	32165	220 E	33160	388 G	34081	226 E	34316	146 D
26996	402 H	31461	216 E	32166	220 E	33162	388 G	34091	226 E	34316	188 D
26997	403 H	31467	216 E	32167	220 E	33163	388 G	34101	226 E	34400	228 E
26998	403 H	31468	216 E	32168	220 E	33164	388 G	34111	226 E	34401	228 E
30003	224 E	31471	216 E	32169	220 E	33165	388 G	34115	226 E	34402	231 E
30003	232 E	31481	216 E	32170	216 E	33166	388 G	34116	226 E	34403	231 E
30004	224 E	31491	216 E	32171	220 E	33167	388 G	34117	226 E	34404	229 E
30004	232 E	31493	218 E	32172	220 E	33168	223 E	34118	226 E	34405	228 E
30005	224 E	31494	218 E	32173	216 E	33168	388 G	34119	226 E	34406	230 E
30005	232 E	31495	218 E	32174	220 E	33169	388 G	34121	226 E	34407	231 E
30007	224 E	31496	218 E	32176	220 E	33170	388 G	34122	226 E	34409	229 E
30007	232 E	31497	218 E	32186	220 E	33173	388 G	34132	226 E	34410	229 E
31005	213 E	31498	216 E	32196	220 E	33200	389 G	34142	226 E	34411	231 E
31006	213 E	31499	216 E	32206	220 E	33200	389 G	34152	226 E	34412	230 E
31007	213 E	31500	216 E	32216	220 E	33201	389 G	34153	226 E	34413	230 E

LIST OF ITEMS

number of item	page	number of item	page	number of item	page	number of item	page	number of item	page	number of item	page
34414	232 E	35085	235 E	35552	241 E	37096	255 E	37236	261 E	37539	244 E
34415	228 E	35086	235 E	35553	241 E	37097	255 E	37237	261 E	37541	244 E
34416	228 E	35087	235 E	35555	241 E	37098	255 E	37238	261 E	37545	246 E
34417	231 E	35091	235 E	35603	244 E	37101	221 E	37239	261 E	37546	246 E
34418	231 E	35092	235 E	35604	244 E	37111	221 E	37243	283 E	37549	246 E
34419	229 E	35093	235 E	35605	244 E	37114	261 E	37244	283 E	37560	246 E
34420	228 E	35094	235 E	35833	239 E	37115	261 E	37245	283 E	37564	245 E
34421	230 E	35095	235 E	35845	239 E	37117	250 E	37246	283 E	37570	200 D
34422	231 E	35096	235 E	35850	239 E	37119	261 E	37247	283 E	37570	246 E
34423	231 E	35103	238 E	36014	249 E	37120	261 E	37248	283 E	37600	289 E
34424	230 E	35113	238 E	36024	249 E	37121	267 E	37250	283 E	37601	289 E
34425	229 E	35123	238 E	36034	249 E	37122	267 E	37251	283 E	37602	289 E
34426	229 E	35125	238 E	36035	249 E	37123	381 G	37252	283 E	37603	289 E
34428	230 E	35126	238 E	36036	249 E	37124	381 G	37253	283 E	37604	289 E
34429	232 E	35127	238 E	36046	249 E	37125	254 E	37255	271 E	37605	289 E
34440	228 E	35300	234 E	36056	250 E	37126	254 E	37256	271 E	37606	289 E
34441	228 E	35310	234 E	36057	250 E	37127	254 E	37257	271 E	37611	289 E
34442	229 E	35311	234 E	36058	250 E	37129	381 G	37258	271 E	37615	289 E
34443	229 E	35316	234 E	36059	250 E	37130	253 E	37259	271 E	37616	289 E
34445	228 E	35317	234 E	36076	248 E	37131	253 E	37263	271 E	37621	379 G
34446	228 E	35318	234 E	36077	248 E	37132	253 E	37264	271 E	37630	379 G
34447	229 E	35319	234 E	36080	248 E	37135	128 C	37266	271 E	37640	378 G
34448	231 E	35320	276 E	36081	248 E	37135	403 H	37267	271 E	37641	378 G
34449	228 E	35320	372 G	36082	248 E	37139	128 C	37268	271 E	37645	378 G
34450	228 E	35322	276 E	36085	248 E	37140	128 C	37270	271 E	37650	379 G
34451	228 E	35322	372 G	36086	248 E	37141	128 C	37271	271 E	37730	238 E
34452	231 E	35323	156 D	36087	248 E	37142	128 C	37272	271 E	37730	372 G
34453	229 E	35323	258 E	36126	249 E	37143	128 C	37273	271 E	37731	238 E
34454	228 E	35325	156 D	36128	249 E	37144	128 C	37275	271 E	37731	372 G
34455	230 E	35325	258 E	36130	249 E	37145	128 C	37280	272 E	37760	238 E
34456	231 E	35326	156 D	36136	249 E	37148	253 E	37281	272 E	37760	372 G
34457	231 E	35326	258 E	36145	247 E	37149	253 E	37290	283 E	37761	238 E
34458	230 E	35327	156 D	36160	247 E	37150	253 E	37291	283 E	37761	372 G
34459	232 E	35327	258 E	36175	247 E	37151	253 E	37295	272 E	38000	274 E
34460	228 E	35328	156 D	36190	247 E	37152	253 E	37295	370 G	38001	273 E
34461	228 E	35328	258 E	36191	247 E	37153	253 E	37296	272 E	38002	274 E
34462	231 E	35329	156 D	36199	248 E	37154	253 E	37296	370 G	38003	274 E
34463	231 E	35329	258 E	36200	248 E	37155	253 E	37297	272 E	38004	274 E
34464	229 E	35330	155 D	36240	248 E	37156	253 E	37297	370 G	38005	274 E
34465	228 E	35330	257 E	36300	246 E	37157	253 E	37300	132 C	38006	273 E
34466	230 E	35331	155 D	36305	373 G	37158	253 E	37301	132 C	38007	274 E
34467	231 E	35331	257 E	36306	373 G	37166	245 E	37302	132 C	38008	274 E
34468	231 E	35335	156 D	36308	260 E	37170	254 E	37303	132 C	38009	274 E
34469	230 E	35335	258 E	36310	245 E	37171	254 E	37308	133 C	38010	273 E
34470	229 E	35345	155 D	36312	260 E	37172	254 E	37309	133 C	38012	273 E
34471	229 E	35345	257 E	36313	373 G	37173	254 E	37310	131 C	38013	273 E
34472	228 E	35346	155 D	36314	373 G	37174	254 E	37311	130 C	38014	274 E
34473	228 E	35346	257 E	36318	373 G	37175	254 E	37312	131 C	38014	274 E
34474	228 E	35347	155 D	36319	373 G	37176	254 E	37313	131 C	38015	275 E
34475	228 E	35347	155 D	37005	279 E	37177	254 E	37314	131 C	38016	275 E
34476	228 E	35347	257 E	37006	251 E	37178	254 E	37317	299 F	38017	275 E
34477	229 E	35347	257 E	37006	251 E	37185	254 E	37320	131 C	38018	275 E
34478	231 E	35350	328 F	37007	251 E	37186	254 E	37321	131 C	38020	273 E
34479	232 E	35360	118 C	37007	251 E	37187	254 E	37325	129 C	38021	275 E
34480	228 E	35361	118 C	37008	251 E	37188	254 E	37326	129 C	38022	275 E
34481	228 E	35362	118 C	37009	251 E	37189	254 E	37328	129 C	38024	273 E
34482	228 E	35500	240 E	37010	391 G	37190	254 E	37330	130 C	38025	273 E
34485	229 E	35501	240 E	37011	251 E	37195	253 E	37331	129 C	38026	252 E
34486	229 E	35502	240 E	37012	251 E	37196	253 E	37332	130 C	38026	276 E
34490	230 E	35503	240 E	37021	251 E	37197	253 E	37340	133 C	38030	276 E
34491	230 E	35504	240 E	37025	250 E	37198	253 E	37341	132 C	38031	275 E
34496	231 E	35505	240 E	37025	250 E	37200	252 E	37342	132 C	38042	252 E
34500	232 E	35506	240 E	37026	250 E	37201	252 E	37343	133 C	38042	276 E
35006	236 E	35507	240 E	37026	250 E	37202	252 E	37344	133 C	38050	268 E
35007	236 E	35508	240 E	37028	250 E	37203	252 E	37345	133 C	38052	268 E
35011	237 E	35510	240 E	37028	250 E	37204	252 E	37350	131 C	38054	268 E
35012	236 E	35511	240 E	37029	250 E	37205	252 E	37500	242 E	38055	268 E
35013	236 E	35512	240 E	37029	250 E	37205	253 E	37501	242 E	38060	268 E
35015	237 E	35514	241 E	37031	221 E	37210	252 E	37505	242 E	38063	268 E
35021	237 E	35515	241 E	37041	221 E	37211	252 E	37506	242 E	38065	268 E
35023	235 E	35516	241 E	37051	221 E	37212	252 E	37509	243 E	38089	268 E
35038	235 E	35517	241 E	37053	251 E	37216	261 E	37510	243 E	38095	267 E
35048	237 E	35518	241 E	37054	251 E	37217	261 E	37511	243 E	38096	267 E
35058	235 E	35519	241 E	37055	251 E	37218	261 E	37512	243 E	38097	267 E
35059	235 E	35524	241 E	37065	255 E	37220	252 E	37515	243 E	38895	256 E
35068	237 E	35525	241 E	37066	255 E	37229	262 E	37516	243 E	38896	256 E
35069	236 E	35527	241 E	37067	255 E	37230	262 E	37517	243 E	38899	256 E
35070	236 E	35532	241 E	37068	255 E	37231	262 E	37518	243 E	38900	256 E
35078	236 E	35533	241 E	37069	255 E	37232	262 E	37527	244 E	38901	256 E
35079	236 E	35539	241 E	37070	255 E	37233	262 E	37530	244 E	38902	256 E
35081	236 E	35540	241 E	37094	255 E	37234	262 E	37532	244 E	38903	256 E
35082	236 E	35542	241 E	37095	255 E	37235	262 E	37533	244 E	38904	256 E

LIST OF ITEMS

number of item	page	number of item	page	number of item	page	number of item	page	number of item	page	number of item	page
38905	256 E	39145	267 E	42163	350 F	44950	150 D	45045	306 F	45131	317 F
38906	256 E	39165	267 E	42170	350 F	44950	302 F	45046	151 D	45132	317 F
38907	256 E	39190	267 E	42171	350 F	44955	304 F	45046	306 F	45133	318 F
38908	256 E	39192	267 E	42172	350 F	44960	309 F	45047	309 F	45134	315 F
38909	256 E	39192	309 F	42173	350 F	44965	330 F	45048	151 D	45135	317 F
38910	256 E	39193	267 E	42174	350 F	44970	298 F	45048	297 F	45136	318 F
38911	256 E	39193	309 F	42175	350 F	44971	298 F	45048	306 F	45137	318 F
38912	256 E	39194	268 E	42176	350 F	44972	294 F	45049	307 F	45138	316 F
38913	256 E	39195	268 E	42177	350 F	44980	294 F	45050	330 F	45139	316 F
38914	256 E	39196	268 E	42178	350 F	44980	294 F	45051	331 F	45140	315 F
38915	256 E	39197	268 E	42179	350 F	44980	296 F	45052	331 F	45141	316 F
38916	256 E	39198	268 E	42180	350 F	44981	294 F	45053	332 F	45142	315 F
38917	256 E	39199	268 E	42181	350 F	44981	294 F	45054	332 F	45143	316 F
38918	256 E	39200	268 E	42182	350 F	44981	295 F	45055	331 F	45144	317 F
38919	252 E	39201	268 E	42185	350 F	44981	296 F	45056	303 F	45145	317 F
38920	252 E	39202	268 E	42186	350 F	44982	295 F	45057	303 F	45146	319 F
38923	252 E	39203	268 E	42187	350 F	44982	295 F	45058	303 F	45147	320 F
38924	270 E	39204	268 E	42188	350 F	44982	296 F	45059	303 F	45150	320 F
38925	270 E	39205	268 E	42190	269 E	44983	295 F	45060	201 D	45151	321 F
38926	272 E	39206	259 E	42190	350 F	44983	295 F	45060	301 F	45152	319 F
38927	270 E	39207	259 E	42201	351 F	44983	295 F	45061	201 D	45153	319 F
38928	271 E	39210	259 E	42202	351 F	44983	296 F	45061	301 F	45154	319 F
38929	270 E	39212	259 E	42203	351 F	44984	296 F	45062	201 D	45155	320 F
38930	272 E	39214	259 E	42207	351 F	44984	297 F	45062	301 F	45156	320 F
38931	270 E	39216	259 E	42208	351 F	44984	297 F	45063	294 F	45158	320 F
38932	270 E	39217	259 E	42209	351 F	44985	296 F	45064	295 F	45159	321 F
38933	272 E	39218	259 E	42210	351 F	44985	297 F	45065	303 F	45160	320 F
38934	271 E	39219	259 E	42211	351 F	44986	296 F	45066	303 F	45161	321 F
38935	272 E	39234	259 E	42212	351 F	44987	296 F	45067	303 F	45162	319 F
38937	272 E	39238	259 E	42213	351 F	44988	296 F	45068	151 D	45163	320 F
38939	272 E	39245	259 E	42214	351 F	44989	296 F	45068	297 F	45164	321 F
38940	272 E	40050	349 F	42217	351 F	44991	296 F	45068	306 F	45167	320 F
38941	272 E	40051	349 F	42218	351 F	44992	296 F	45069	150 D	45168	321 F
38942	271 E	40052	349 F	42219	351 F	44995	300 F	45069	302 F	45169	321 F
38943	272 E	40053	349 F	42220	351 F	44996	296 F	45070	332 F	45170	323 F
38944	269 E	40054	349 F	42221	351 F	44997	297 F	45071	331 F	45171	323 F
38945	269 E	40055	349 F	42228	351 F	44998	297 F	45074	308 F	45172	323 F
38946	269 E	40056	349 F	42229	351 F	44999	299 F	45079	304 F	45172	323 F
38947	269 E	40057	349 F	42230	351 F	45000	299 F	45080	304 F	45173	323 F
38948	269 E	40058	349 F	42240	351 F	45001	299 F	45081	150 D	45173	323 F
38949	269 E	40059	349 F	42244	351 F	45002	300 F	45081	302 F	45174	323 F
38950	260 E	40060	349 F	42248	351 F	45003	300 F	45082	150 D	45175	322 F
38951	260 E	40075	349 F	42249	351 F	45005	300 F	45082	302 F	45176	322 F
38952	260 E	40076	349 F	42251	351 F	45006	300 F	45083	150 D	45177	322 F
38953	260 E	40100	349 F	42252	351 F	45007	300 F	45083	302 F	45178	322 F
38954	260 E	40120	349 F	42253	351 F	45008	300 F	45084	150 D	45179	321 F
38955	269 E	41050	349 F	42255	351 F	45009	300 F	45084	302 F	45180	315 F
38956	269 E	41080	349 F	42256	351 F	45010	297 F	45085	309 F	45181	315 F
38957	269 E	41081	349 F	42257	351 F	45011	299 F	45086	308 F	45182	322 F
38958	269 E	41082	349 F	42260	351 F	45012	299 F	45088	295 F	45183	322 F
38959	269 E	41083	349 F	42261	351 F	45014	297 F	45089	295 F	45184	321 F
38960	269 E	41100	349 F	42312	259 E	45015	299 F	45093	309 F	45185	321 F
38961	269 E	41101	349 F	42312	350 F	45016	298 F	45094	296 F	45186	321 F
38963	272 E	41102	349 F	42365	268 E	45017	296 F	45095	295 F	45187	322 F
38964	270 E	41103	349 F	42366	268 E	45018	297 F	45096	295 F	45190	324 F
38965	271 E	41120	349 F	42367	268 E	45019	298 F	45097	295 F	45191	324 F
38966	270 E	41121	349 F	42368	268 E	45020	294 F	45098	295 F	45192	324 F
38968	270 E	41122	349 F	42420	259 E	45021	298 F	45099	295 F	45193	324 F
38969	272 E	41123	349 F	43050	355 F	45023	294 F	45100	326 F	45194	324 F
38970	260 E	41150	349 F	43058	356 F	45025	298 F	45101	326 F	45195	324 F
38971	260 E	41151	349 F	43060	356 F	45026	297 F	45102	326 F	45196	324 F
38972	272 E	41152	349 F	43068	356 F	45027	298 F	45104	326 F	45197	324 F
38973	272 E	41153	349 F	43071	355 F	45029	298 F	45105	326 F	45198	324 F
38980	270 E	42101	349 F	43072	355 F	45030	201 D	45106	326 F	45199	324 F
38981	270 E	42102	349 F	43077	355 F	45030	301 F	45107	326 F	45200	324 F
38985	272 E	42103	349 F	43082	356 F	45031	201 D	45108	326 F	45203	325 F
38990	270 E	42110	259 E	43083	356 F	45031	301 F	45110	314 F	45204	325 F
38991	270 E	42112	259 E	43084	356 F	45032	201 D	45111	314 F	45206	324 F
38995	271 E	42113	259 E	43086	356 F	45032	301 F	45112	315 F	45211	325 F
39000	267 E	42115	262 E	43087	357 F	45033	201 D	45113	314 F	45213	317 F
39001	267 E	42120	262 E	43089	357 F	45033	301 F	45114	314 F	45214	319 F
39002	267 E	42150	350 F	43090	357 F	45034	304 F	45115	314 F	45215	318 F
39003	267 E	42151	350 F	43097	356 F	45035	303 F	45116	314 F	45216	319 F
39005	267 E	42152	350 F	43098	357 F	45036	307 F	45117	313 F	45217	319 F
39010	267 E	42153	350 F	43099	357 F	45038	304 F	45118	313 F	45218	318 F
39012	267 E	42155	350 F	43300	347 F	45039	304 F	45120	314 F	45219	318 F
39014	267 E	42156	350 F	43301	347 F	45040	304 F	45122	314 F	45220	325 F
39020	267 E	42157	350 F	44041	307 F	45041	304 F	45123	313 F	45221	325 F
39021	267 E	42158	350 F	44042	307 F	45042	309 F	45124	313 F	45222	325 F
39045	267 E	42160	350 F	44043	307 F	45043	306 F	45125	313 F	45223	325 F
39065	267 E	42161	350 F	44050	307 F	45044	307 F	45126	313 F	45224	325 F
39090	267 E	42162	350 F	44053	309 F	45045	151 D	45130	317 F	45225	325 F

LIST OF ITEMS

number of item	page	number of item	page	number of item	page	number of item	page	number of item	page	number of item	page
45226	325 F	45392	311 F	45558	308 F	48022	120 C	50033	352 F	50907	369 G
45227	325 F	45393	311 F	45559	308 F	48030	120 C	50035	352 F	50909	369 G
45228	325 F	45394	311 F	45560	307 F	48031	121 C	50036	402 H	50910	369 G
45229	325 F	45395	311 F	45562	308 F	48032	121 C	50037	352 F	50911	369 G
45239	328 F	45396	311 F	45563	308 F	48033	121 C	50036	402 H	50915	369 G
45240	328 F	45397	311 F	45564	308 F	48034	121 C	50037	352 F	50916	369 G
45241	328 F	45398	312 F	45565	308 F	48036	119 C	50038	352 F	50917	369 G
45242	328 F	45399	312 F	45570	350 F	48037	120 C	50040	351 F	50918	369 G
45244	327 F	45400	312 F	45571	350 F	48040	121 C	50041	351 F	50919	369 G
45245	327 F	45401	312 F	45572	350 F	48041	121 C	50042	351 F	50920	369 G
45246	327 F	45410	354 F	45573	350 F	48042	121 C	50050	268 E	51001	368 G
45247	327 F	45415	354 F	45580	350 F	48043	121 C	50050	268 E	51002	368 G
45248	327 F	45420	354 F	45600	325 F	48046	120 C	50051	268 E	51003	368 G
45249	327 F	45425	354 F	45601	325 F	48046	121 C	50052	268 E	51004	368 G
45250	327 F	45426	354 F	45602	325 F	48047	120 C	50052	268 E	51007	368 G
45251	327 F	45427	354 F	45603	325 F	48047	121 C	50100	286 E	51008	367 G
45253	327 F	45450	354 F	45604	325 F	48050	122 C	50101	286 E	51009	368 G
45254	327 F	45451	354 F	45605	325 F	48051	122 C	50102	286 E	51010	368 G
45256	327 F	45452	354 F	45606	325 F	48054	122 C	50103	286 E	51011	368 G
45257	327 F	45453	354 F	45607	325 F	48055	122 C	50104	286 E	51013	367 G
45260	327 F	45460	354 F	45608	325 F	48056	122 C	50106	286 E	51015	368 G
45261	327 F	45461	354 F	45609	325 F	48057	122 C	50108	286 E	51017	367 G
45262	327 F	45462	354 F	45610	325 F	48060	122 C	50500	125 C	51018	367 G
45262	328 F	45463	354 F	45611	325 F	48061	122 C	50501	125 C	51020	367 G
45263	327 F	45465	354 F	45612	325 F	48062	122 C	50502	125 C	51022	367 G
45263	328 F	45466	354 F	45613	325 F	48063	122 C	50503	125 C	51023	367 G
45265	328 F	45467	354 F	45614	325 F	48064	122 C	50505	125 C	51026	366 G
45266	328 F	45470	354 F	45615	325 F	48065	122 C	50510	123 C	51030	367 G
45267	327 F	45471	272 E	45616	325 F	48066	122 C	50511	123 C	51034	367 G
45267	328 F	45471	306 F	45617	325 F	48067	122 C	50512	123 C	51036	368 G
45268	327 F	45471	370 G	45618	325 F	48068	122 C	50513	123 C	51037	368 G
45268	328 F	45472	306 F	45619	325 F	48070	122 C	50514	123 C	51038	368 G
45269	328 F	45473	306 F	45620	325 F	48071	122 C	50518	125 C	51040	366 G
45270	327 F	45480	354 F	45621	325 F	48072	122 C	50519	125 C	51041	366 G
45271	327 F	45485	354 F	45622	325 F	48075	122 C	50520	125 C	51042	366 G
45272	327 F	45490	342 F	45623	325 F	48076	122 C	50521	125 C	51043	366 G
45273	327 F	45496	354 F	45624	325 F	48077	122 C	50522	126 C	51045	367 G
45274	327 F	45497	354 F	45625	325 F	48080	122 C	50523	125 C	51046	367 G
45280	326 F	45498	354 F	45626	325 F	48081	122 C	50524	125 C	51050	369 G
45283	326 F	45499	354 F	45627	325 F	48085	122 C	50525	126 C	51051	369 G
45285	326 F	45500	305 F	45628	325 F	48086	122 C	50526	126 C	51055	369 G
45286	326 F	45502	305 F	45629	325 F	48087	122 C	50527	127 C	51056	369 G
45287	326 F	45503	305 F	45630	325 F	48090	122 C	50529	126 C	51057	369 G
45289	317 F	45505	305 F	45631	325 F	48091	122 C	50530	127 C	51060	366 G
45290	317 F	45506	305 F	45632	325 F	48093	122 C	50531	126 C	51065	366 G
45291	317 F	45508	305 F	45633	325 F	48094	122 C	50532	127 C	51070	366 G
45292	318 F	45509	305 F	45634	325 F	48095	122 C	50533	126 C	51071	366 G
45293	318 F	45511	305 F	45635	325 F	48096	122 C	50537	126 C	51072	366 G
45294	316 F	45512	305 F	45636	325 F	48097	122 C	50539	126 C	51100	288 E
45295	316 F	45513	305 F	45637	325 F	48410	290 E	50540	127 C	51101	288 E
45296	315 F	45515	305 F	45638	325 F	48411	290 E	50541	127 C	51102	288 E
45297	316 F	45516	305 F	45639	325 F	48415	290 E	50542	127 C	51103	288 E
45298	315 F	45517	305 F	45650	307 F	48420	290 E	50544	127 C	51104	288 E
45299	316 F	45518	305 F	45651	307 F	48452	290 E	50549	126 C	51105	288 E
45300	323 F	45519	305 F	45652	307 F	48453	290 E	50550	124 C	51106	288 E
45301	323 F	45520	305 F	45653	307 F	48454	290 E	50551	124 C	51107	288 E
45320	331 F	45521	305 F	45654	307 F	48455	290 E	50553	124 C	51108	288 E
45321	332 F	45522	305 F	45655	307 F	48456	290 E	50554	124 C	51109	288 E
45323	330 F	45523	305 F	45656	307 F	48457	290 E	50555	127 C	51110	288 E
45323	344 F	45524	305 F	45657	307 F	48719	246 E	50556	124 C	51111	288 E
45325	330 F	45525	305 F	45658	307 F	48729	245 E	50557	126 C	51120	288 E
45326	330 F	45526	305 F	45659	307 F	48730	245 E	50558	126 C	51121	288 E
45327	329 F	45527	305 F	45660	307 F	48731	245 E	50559	124 C	51122	288 E
45328	329 F	45528	305 F	45661	307 F	50004	374 G	50560	124 C	51123	288 E
45329	329 F	45529	305 F	45662	307 F	50005	374 G	50562	124 C	51124	288 E
45330	347 F	45530	305 F	45663	307 F	50009	375 G	50563	124 C	51125	288 E
45331	347 F	45531	305 F	45664	307 F	50010	375 G	50564	124 C	51126	288 E
45345	323 F	45532	305 F	45670	307 F	50011	375 G	50570	124 C	51127	288 E
45349	323 F	45533	305 F	45671	307 F	50012	375 G	50571	124 C	51130	288 E
45350	323 F	45534	305 F	45672	307 F	50013	375 G	50585	127 C	51131	288 E
45353	323 F	45535	308 F	45673	307 F	50014	375 G	50585	283 E	51132	288 E
45360	323 F	45540	308 F	48001	119 C	50015	375 G	50586	127 C	51181	375 G
45364	323 F	45541	308 F	48002	119 C	50017	377 G	50586	283 E	51182	375 G
45366	323 F	45542	308 F	48005	120 C	50019	377 G	50587	127 C	51186	369 G
45370	151 D	45543	308 F	48006	120 C	50020	377 G	50587	283 E	51187	369 G
45370	306 F	45550	308 F	48007	120 C	50021	377 G	50588	127 C	51196	288 E
45385	310 F	45551	308 F	48008	121 C	50022	377 G	50588	283 E	51197	288 E
45386	310 F	45552	308 F	48009	121 C	50025	377 G	50900	369 G	51198	288 E
45388	310 F	45553	308 F	48010	121 C	50026	377 G	50901	369 G	51199	288 E
45389	310 F	45555	308 F	48015	119 C	50030	352 F	50902	369 G	51200	369 G
45390	311 F	45556	308 F	48020	120 C	50031	352 F	50905	369 G	51201	369 G
45391	311 F	45557	308 F	48021	120 C	50032	352 F	50906	369 G	51202	369 G

LIST OF ITEMS

number of item	page	number of item	page	number of item	page	number of item	page	number of item	page	number of item	page
51203	369 G	51420	287 E	52215	278 E	55350	117 C	61020	336 F	61164	339 F
51204	286 E	51430	287 E	52216	278 E	55351	117 C	61021	335 F	61165	339 F
51205	286 E	51431	287 E	52217	278 E	55352	117 C	61022	336 F	61166	339 F
51206	286 E	51432	287 E	52218	278 E	55353	117 C	61024	337 F	61169	233 E
51207	286 E	51433	287 E	52220	278 E	55354	117 C	61025	335 F	61171	347 F
51208	286 E	51435	287 E	52283	278 E	55355	117 C	61026	335 F	61172	344 F
51209	286 E	51436	287 E	52284	278 E	55356	117 C	61028	339 F	61172	347 F
51210	286 E	51450	287 E	52285	278 E	55357	117 C	61029	335 F	61173	347 F
51211	286 E	51500	363 G	52286	278 E	55358	117 C	61030	333 F	61174	347 F
51212	286 E	51510	363 G	52288	278 E	55359	117 C	61031	333 F	61175	347 F
51220	287 E	51511	363 G	52305	281 E	55360	117 C	61032	333 F	61176	347 F
51221	287 E	51512	363 G	52306	281 E	55361	117 C	61033	333 F	61177	347 F
51222	287 E	51513	363 G	52315	281 E	55362	117 C	61034	333 F	61183	348 F
51225	287 E	51514	363 G	52328	281 E	55400	353 F	61035	340 F	61184	348 F
51226	287 E	51515	363 G	52331	281 E	55401	353 F	61036	340 F	61189	348 F
51227	287 E	51516	363 G	52334	281 E	55402	353 F	61038	340 F	61190	348 F
51241	286 E	51517	363 G	52391	281 E	55403	353 F	61040	340 F	61192	347 F
51242	286 E	52010	376 G	52421	281 E	55404	353 F	61042	340 F	61193	347 F
51243	286 E	52012	376 G	52424	281 E	55405	353 F	61044	339 F	61194	347 F
51244	286 E	52020	376 G	52428	281 E	55406	353 F	61045	333 F	61195	348 F
51245	286 E	52030	226 E	52456	281 E	55420	353 F	61046	333 F	61200	347 F
51246	286 E	52030	376 G	52471	282 E	55421	353 F	61047	333 F	61201	347 F
51247	286 E	52050	290 E	52600	280 E	55422	353 F	61048	333 F	61201	347 F
51257	288 E	52055	290 E	52601	282 E	55423	353 F	61050	336 F	61202	348 F
51258	288 E	52060	290 E	52602	280 E	55424	353 F	61051	336 F	61203	339 F
51259	288 E	52065	290 E	52605	280 E	55425	353 F	61052	337 F	61204	348 F
51260	288 E	52070	278 E	52610	280 E	55429	353 F	61053	336 F	61205	348 F
51261	288 E	52071	279 E	52620	283 E	55430	353 F	61054	337 F	61206	348 F
51262	288 E	52075	279 E	52625	283 E	55431	353 F	61056	335 F	61207	348 F
51263	288 E	52076	279 E	52630	283 E	55432	353 F	61057	335 F	61208	348 F
51264	288 E	52077	279 E	52635	283 E	55433	353 F	61058	337 F	61209	339 F
51265	288 E	52078	279 E	52640	283 E	55436	353 F	61059	337 F	61215	348 F
51271	286 E	52101	344 F	52645	283 E	55437	353 F	61060	333 F	61218	233 E
51272	286 E	52102	344 F	52652	283 E	55450	352 F	61061	333 F	61219	348 F
51273	286 E	52103	344 F	52656	283 E	55452	353 F	61062	333 F	61221	341 F
51274	286 E	52104	344 F	52662	282 E	55453	353 F	61063	333 F	61221	341 F
51275	286 E	52105	344 F	52666	282 E	55454	353 F	61067	341 F	61221	341 F
51276	286 E	52108	344 F	52671	282 E	55455	353 F	61068	341 F	61221	341 F
51278	286 E	52109	345 F	52694	282 E	55456	353 F	61069	341 F	61222	339 F
51280	287 E	52110	374 G	52695	282 E	55457	353 F	61070	341 F	61223	338 F
51281	287 E	52111	374 G	54008	283 E	55460	353 F	61077	342 F	61224	340 F
51282	287 E	52113	345 F	55040	117 C	55461	353 F	61079	342 F	61224	340 F
51283	287 E	52114	345 F	55041	117 C	55462	353 F	61085	304 F	61230	348 F
51284	287 E	52115	345 F	55050	117 C	55640	291 E	61088	336 F	61235	376 G
51286	287 E	52116	345 F	55051	117 C	55642	291 E	61089	335 F	61236	376 G
51287	287 E	52119	343 F	55060	117 C	55645	291 E	61090	336 F	61240	92 C
51288	287 E	52125	347 F	55080	117 C	60001	346 F	61097	338 F	61250	348 F
51300	286 E	52126	347 F	55100	117 C	60006	346 F	61098	338 F	61251	309 F
51301	286 E	52130	252 E	55101	117 C	60008	346 F	61111	340 F	61251	348 F
51302	286 E	52160	344 F	55120	117 C	60012	346 F	61112	340 F	61252	348 F
51303	286 E	52161	344 F	55121	117 C	60018	347 F	61114	340 F	61253	348 F
51304	286 E	52162	344 F	55140	117 C	60019	347 F	61120	340 F	61254	348 F
51305	286 E	52163	344 F	55141	117 C	60020	347 F	61121	340 F	61255	348 F
51306	286 E	52164	344 F	55160	117 C	60022	347 F	61130	331 F	61256	348 F
51307	286 E	52168	343 F	55180	117 C	60100	233 E	61131	331 F	61290	341 F
51308	286 E	52173	343 F	55181	117 C	60115	245 E	61132	331 F	61291	341 F
51320	286 E	52175	343 F	55200	117 C	60116	245 E	61133	331 F	61292	341 F
51321	286 E	52176	343 F	55201	117 C	60117	245 E	61134	332 F	61293	341 F
51322	286 E	52185	344 F	55220	117 C	60118	245 E	61135	332 F	61294	341 F
51323	286 E	52186	344 F	55221	117 C	60121	245 E	61136	329 F	61295	341 F
51324	286 E	52187	344 F	55240	117 C	60123	245 E	61137	329 F	61296	341 F
51325	286 E	52188	344 F	55300	117 C	60201	346 F	61138	329 F	61297	341 F
51327	286 E	52189	344 F	55301	117 C	60206	346 F	61139	330 F	61299	352 F
51338	288 E	52190	344 F	55311	117 C	60208	346 F	61140	330 F	61300	352 F
51340	288 E	52191	344 F	55313	117 C	60212	346 F	61141	332 F	61301	352 F
51341	288 E	52192	344 F	55314	117 C	61000	336 F	61142	332 F	61302	352 F
51348	288 E	52193	344 F	55315	117 C	61001	336 F	61143	333 F	61320	92 C
51402	287 E	52194	344 F	55316	117 C	61002	337 F	61144	333 F	61321	92 C
51403	287 E	52195	345 F	55317	117 C	61003	338 F	61145	333 F	61322	92 C
51404	287 E	52196	345 F	55318	117 C	61004	337 F	61146	333 F	61323	92 C
51405	287 E	52197	344 F	55319	117 C	61005	334 F	61147	329 F	61324	92 C
51406	287 E	52198	343 F	55331	117 C	61006	334 F	61148	329 F	61325	92 C
51407	287 E	52202	278 E	55332	117 C	61007	335 F	61149	330 F	61326	92 C
51408	287 E	52203	278 E	55333	117 C	61008	334 F	61150	331 F	61327	92 C
51410	287 E	52204	278 E	55334	117 C	61009	339 F	61151	331 F	61328	92 C
51412	287 E	52205	278 E	55335	117 C	61010	335 F	61155	334 F	61329	92 C
51413	287 E	52206	278 E	55336	117 C	61012	339 F	61156	334 F	61330	92 C
51414	287 E	52207	278 E	55337	117 C	61013	338 F	61157	334 F	61331	92 C
51415	287 E	52208	278 E	55339	117 C	61014	339 F	61158	334 F	61340	95 C
51416	287 E	52212	278 E	55340	117 C	61015	335 F	61161	337 F	61341	95 C
51417	287 E	52213	278 E	55341	117 C	61018	338 F	61162	338 F	61342	95 C
51418	287 E	52214	278 E	55342	117 C	61019	338 F	61163	338 F	61343	95 C

number of item	page	number of item	page	number of item	page	number of item	page	number of item	page	number of item	page
61344	95 C	70221	374 G	81231	383 G	81314	383 G	81398	383 G	89973	277 E
61345	95 C	81011	382 G	81232	383 G	81315	383 G	81399	383 G	89973	371 G
61346	95 C	81012	382 G	81233	383 G	81316	383 G	81400	383 G	89975	277 E
65062	291 E	81013	382 G	81234	383 G	81317	383 G	81401	383 G	89975	371 G
65063	291 E	81014	382 G	81235	383 G	81318	383 G	81402	383 G	89980	277 E
65064	291 E	81015	382 G	81236	383 G	81319	383 G	81403	383 G	89980	371 G
65065	291 E	81016	382 G	81237	383 G	81320	383 G	81404	383 G	89985	277 E
69900	264 E	81022	382 G	81238	383 G	81321	383 G	81405	383 G	89985	371 G
69901	264 E	81023	382 G	81239	383 G	81322	383 G	81406	383 G	89987	277 E
69902	264 E	81024	382 G	81240	383 G	81323	383 G	81407	383 G	89987	371 G
69903	264 E	81025	382 G	81241	383 G	81324	383 G	81408	383 G	89988	277 E
69904	263 E	81035	382 G	81242	383 G	81325	383 G	81409	383 G	89988	371 G
69905	264 E	81036	382 G	81243	383 G	81326	383 G	81410	383 G	89989	277 E
69906	264 E	81053	380 G	81244	383 G	81327	383 G	81411	383 G	89989	371 G
69907	266 E	81054	380 G	81245	383 G	81328	383 G	81412	383 G	89990	277 E
69908	266 E	81055	380 G	81246	383 G	81329	383 G	81413	383 G	89990	371 G
69909	266 E	81056	380 G	81247	383 G	81330	383 G	81414	383 G	90070	250 E
69910	265 E	81057	380 G	81248	383 G	81331	383 G	81415	383 G	90071	250 E
69911	265 E	81070	380 G	81249	383 G	81332	383 G	81416	383 G	90072	250 E
69912	265 E	81071	380 G	81250	383 G	81333	383 G	81417	383 G		
69914	264 E	81072	380 G	81251	383 G	81334	383 G	81418	383 G		
69917	265 E	81073	380 G	81252	383 G	81335	383 G	81419	383 G		
69918	263 E	81074	380 G	81253	383 G	81336	383 G	81420	383 G		
69919	263 E	81075	380 G	81254	383 G	81337	383 G	81421	383 G		
69920	266 E	81076	380 G	81255	383 G	81338	383 G	81422	383 G		
69923	266 E	81077	380 G	81256	383 G	81339	383 G	81423	383 G		
69928	266 E	81100	380 G	81257	383 G	81340	383 G	81424	383 G		
69930	265 E	81101	380 G	81258	383 G	81341	383 G	81425	383 G		
69931	265 E	81102	380 G	81259	383 G	81342	383 G	81426	383 G		
70020	114 C	81103	380 G	81260	383 G	81343	383 G	81427	383 G		
70021	114 C	81104	380 G	81261	383 G	81344	383 G	81428	383 G		
70025	114 C	81105	380 G	81262	383 G	81345	383 G	81429	383 G		
70026	114 C	81106	380 G	81263	383 G	81346	383 G	81430	383 G		
70030	114 C	81113	380 G	81264	383 G	81347	383 G	81431	383 G		
70031	114 C	81114	380 G	81265	383 G	81348	383 G	81432	383 G		
70032	114 C	81115	380 G	81266	383 G	81349	383 G	81433	383 G		
70033	114 C	81150	384 G	81267	383 G	81350	383 G	81434	383 G		
70035	114 C	81151	384 G	81268	383 G	81351	383 G	81435	383 G		
70036	114 C	81152	384 G	81269	383 G	81352	383 G	81436	383 G		
70037	114 C	81155	384 G	81270	383 G	81353	383 G	81437	383 G		
70038	114 C	81160	385 G	81271	383 G	81354	383 G	81438	383 G		
70040	114 C	81165	385 G	81272	383 G	81355	383 G	81439	383 G		
70045	114 C	81170	384 G	81273	383 G	81356	383 G	81440	383 G		
70046	114 C	81175	385 G	81274	383 G	81357	383 G	81441	383 G		
70060	115 C	81178	385 G	81275	383 G	81358	383 G	81442	383 G		
70061	115 C	81180	385 G	81276	383 G	81359	383 G	81443	383 G		
70062	115 C	81185	384 G	81277	383 G	81360	383 G	81444	383 G		
70063	115 C	81186	384 G	81278	383 G	81361	383 G	81445	383 G		
70064	115 C	81189	384 G	81279	383 G	81362	383 G	81447	383 G		
70065	116 C	81190	385 G	81280	383 G	81363	383 G	81448	383 G		
70066	115 C	81191	385 G	81281	383 G	81364	383 G	81449	383 G		
70070	116 C	81200	383 G	81282	383 G	81365	383 G	81450	383 G		
70075	116 C	81201	383 G	81284	383 G	81366	383 G	81451	383 G		
70090	116 C	81202	383 G	81285	383 G	81367	383 G	81452	383 G		
70091	116 C	81203	383 G	81286	383 G	81370	383 G	81453	383 G		
70092	116 C	81204	383 G	81287	383 G	81371	383 G	81454	383 G		
70093	116 C	81205	383 G	81288	383 G	81372	383 G	81455	383 G		
70094	116 C	81206	383 G	81289	383 G	81373	383 G	81456	383 G		
70095	116 C	81207	383 G	81290	383 G	81374	383 G	81457	383 G		
70096	116 C	81208	383 G	81291	383 G	81375	383 G	81458	383 G		
70098	70 C	81209	383 G	81292	383 G	81376	383 G	81459	383 G		
70100	365 G	81210	383 G	81293	383 G	81377	383 G	81460	383 G		
70101	365 G	81211	383 G	81294	383 G	81378	383 G	81461	383 G		
70102	365 G	81212	383 G	81295	383 G	81379	383 G	81462	383 G		
70103	365 G	81213	383 G	81296	383 G	81380	383 G	81463	383 G		
70104	365 G	81214	383 G	81297	383 G	81381	383 G	81466	383 G		
70105	365 G	81215	383 G	81298	383 G	81382	383 G	81467	383 G		
70106	365 G	81216	383 G	81299	383 G	81383	383 G	81468	383 G		
70107	365 G	81217	383 G	81300	383 G	81384	383 G	81469	383 G		
70108	365 G	81218	383 G	81301	383 G	81385	383 G	81470	383 G		
70109	365 G	81219	383 G	81302	383 G	81386	383 G	81471	383 G		
70110	365 G	81220	383 G	81303	383 G	81387	383 G	81472	383 G		
70114	364 G	81221	383 G	81304	383 G	81388	383 G	81473	383 G		
70120	364 G	81222	383 G	81305	383 G	81389	383 G	81486	383 G		
70121	364 G	81223	383 G	81306	383 G	81390	383 G	81600	381 G		
70122	364 G	81224	383 G	81307	383 G	81391	383 G	81603	381 G		
70123	364 G	81225	383 G	81308	383 G	81392	383 G	82101	262 E		
70124	364 G	81226	383 G	81309	383 G	81393	383 G	82104	262 E		
70125	364 G	81227	383 G	81310	383 G	81394	383 G	82105	262 E		
70140	364 G	81228	383 G	81311	383 G	81395	383 G	82109	262 E		
70141	364 G	81229	383 G	81312	383 G	81396	383 G	89970	277 E		
70220	374 G	81230	383 G	81313	383 G	81397	383 G	89970	371 G		

FESTA[®]

PROFESSIONAL  TOOLS

2022





Brand of high quality hand tools for building, workshop and garden



Brand of top quality levels



Brand of high quality levels and mason staff



Professional watering assortment with modern design, compatible with Rosa product line



Quality watering systems and garden tools



Japanese knives with a long tradition



Professional measuring tapes



Professional tile cutter



Manufacturer of quality garden shears



Professional building mixers



Professional screwdriver attachments



Brand of professional saws

GRAPHIC SYMBOLS USED IN CATALOG

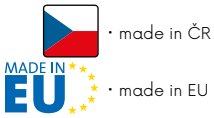

PRODUCT SPECIFICATIONS USED ICONS

- S2** · functional parts made of high-alloy tool steels S2
- HSS** · functional parts made of high-speed steel
- Cr-Mo** · functional parts from chrome-molybdenum steel
- CrV** · functional parts from chrome-vanadium steel
- INOX** · functional parts from stainless steel
- NYLON** · nylon handle
- TEFLON** · teflon surface
- Zn** · zinc coated surface
- TiN** · titanium nitride coated surface
- HRC 58-61** · the hardness of the functional parts material (Rockwell)
- 40% PES** · material composition - contains 40% of polyester
- PES** · material composition - made of polyester
- Diamond** · diamond grains on the surface of functional parts
- Magnet** · magnetic

- SDS+** · mounting type
- SDS MAX** · mounting type
- M14** · mounting type
- 72T** · number of ratchet teeth
- 36T** · number of ratchet teeth
- 1/2"** · mounting size
- 3/4"** · mounting size
- 1/4"** · mounting size
- 27 dB** · information about hearing protection
- DIN 3113** · complies with this standard
- IP 54** · complies with this standard
- 32x** · set contains this number of products
- II. class** · complies with the specified accuracy class
- III. class** · complies with the specified accuracy class
- Cold Weather** · suitable for cold weather
- ERGO HANDLE** · ergonomic handle
- HOBBY** · for hobby use
- 2x AAA** · number and type of batteries
- UV STABLE** · UV stable
- RUBBER ENDS** · crashproof rubber ends

APPLICATION SPECIFICATIONS

- wood
- ceramics
- plastic
- aluminium
- copper
- stone
- glass
- wall
- paper
- steel
- composite
- tiles
- stainless steel
- plaster
- wood with screw, nails
- drywall
- for drilling in materials with tensile strength up to ...

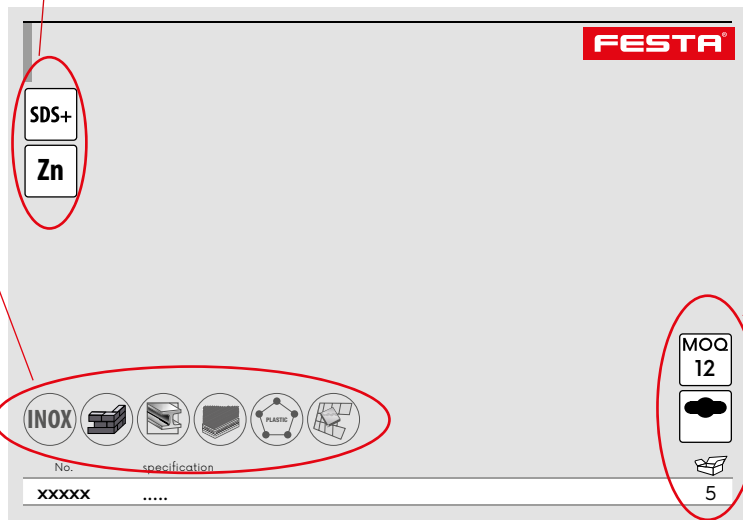

PACKAGING INFORMATION

- Box** · packed in a box
- Euroslot** · packed with euroslot
- MOQ 12** · minimum order quantity
- 5** · no. of pieces in the package

WATERING PRODUCTS SPECIFICATIONS

- adjustable spray patterns
- minimum and maximum pressure
- maximum water flow
- irrigated area
- adaptor thread size
- hose diameter for connector

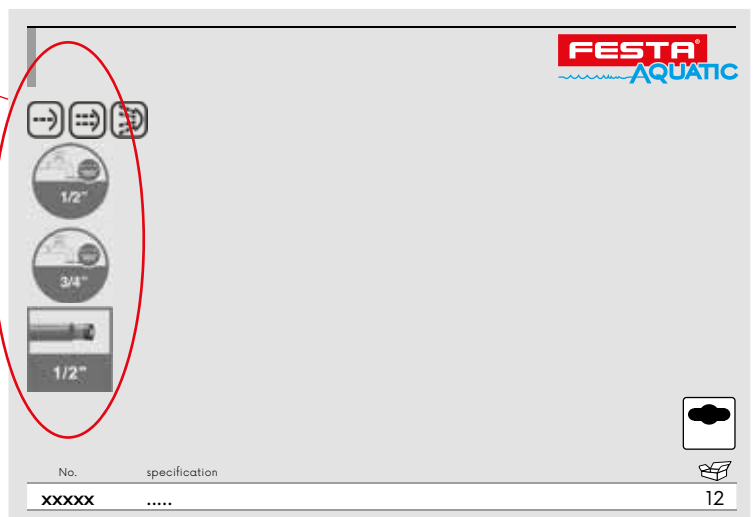

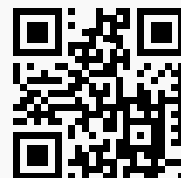

2022



PROFESSIONAL X TOOLS

www.festa.tools

HORIZONT.

FESTA
AQUATIC



ROSA

KOMELON.

KDS

Stahlberg

SUPER PRO

Lescha



WINLAND