



FESTA

ПРОФЕСИОНАЛНИ  ИНСТРУМЕНТИ



20
25
—
26

FESTA
POWER X TOOLS

Електроинструменти и Акумулаторни ,инструменти с използване на качествени компоненти, с най-новите технологии и актуални тенденции в този асортимент.

FESTA

Марка професионални ръчни инструменти в строителство, ремонт, и градина

FESTA
INDUSTRY

Първокласна линия от избрани инструменти и ръчни инструменти с най-високо качество, предназначени за високотелни условия на работа, където производителността е ключова.

FESTA
AQUATIC

Професионални инструменти за поливане, атрактивен дизайн, съвместими с продукти Rosa

HORIZONT
MASTER

Висококачествени нивелири

HORIZONT

Висококачествени нивелири и мастари

ROSA

Качествени системи за напояване и градински инструменти

KDS

Японски инструменти за рязане

КОМЕЛОП

Професионални измервателни ролетки



Професионални машини и инструменти за рязане на гранитогрес



Качествени градински инструменти

Lescha

Професионални машини за миксиране на бетон

Stahlberg

Професионални винтоверти и работни инструменти



Професионални режещи инструменти

АКУМУЛАТОРНИ И ЕЛЕКТРОИНСТРУМЕНТИ

2 - 53



ИНСТРУМЕНТИ ЗА РЯЗАНЕ И ШЛИФОВАНЕ

54 - 93



РЪЧНИ ИНСТРУМЕНТИ

94 - 205



РАБОТИЛНИЦА

206 - 241



СТРОИТЕЛНИ ИНСТРУМЕНТИ

242 - 307

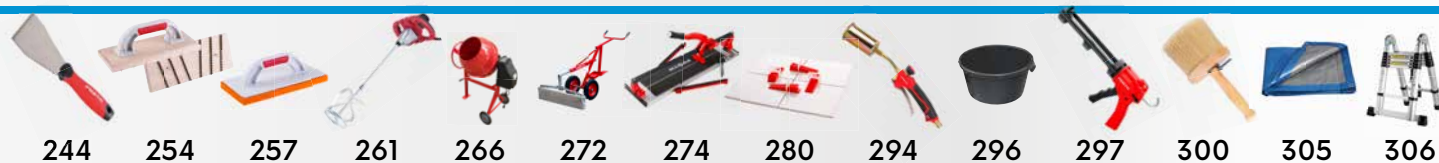

ГРАДИНСКИ ИНСТРУМЕНТИ

308 - 359



FESTA

360 - 365



СПИСЪК ПРОДУКТИ

366 - 380



БОРМОШИНА

4



УДАРНА БОРМОШИНА

9



ЗАБИВАЧ

10



ШЛАЙФ

11



ЕКСЦЕНТРИК ШЛАЙФ

12



ЦИРКУЛЯР

13



КОМПРЕСОР ЗА ВЪЗДУХ

15



ВИБРАЦИОННА
МАШИНА ЗА ПЛОЧКИ

16



ПИСТОЛЕТ ЗА
УПЛЪТНИТЕЛИ

17

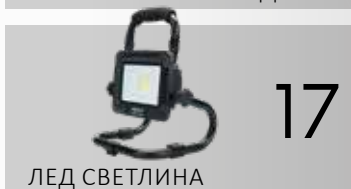

ЛЕД СВЕТИЛНА

17



РАДИО DAB+ / FM / BT

18



УДАРНА БОРМОШИНА

23



ЦИРКУЛЯР

26



ШЛАЙФ

27



ШЛАЙФ ЗА ГИПСОКАРТОН

36



ПРАХОСМУКАЧКИ

37

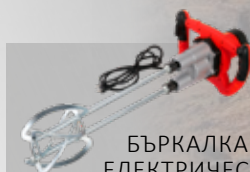

БЪРКАЛКА
ЕЛЕКТРИЧЕСКА
ЗА СТРОИТЕЛНИ СМЕСИ

38

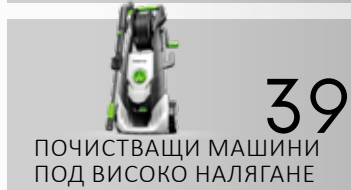

ПОЧИСТВАЩИ МАШИНИ
ПОД ВИСОКО НАЛЯГАНЕ

39

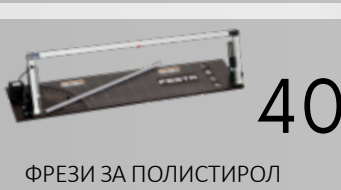

ФРЕЗИ ЗА ПОЛИСТИРОЛ

40



ЗАВАРЪЧЕН ИНВЕРТОР

43



ПОЛИФУЗИОННИ
ЗАВАРЧИЦИ

45



КОМПРЕСОРИ
И АКСЕСОАРИ

46

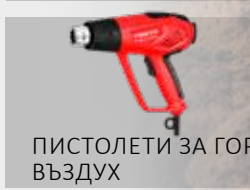

ПИСТОЛЕТИ ЗА ГОРЕЩ
ВЪЗДУХ

50



НАГРЕВАТЕЛИ

52



УДЪЛЖИТЕЛНИ КАБЕЛИ

53



ЕЛЕКТРИЧЕСКИ
ИНСТРУМЕНТИ

2 - 53



FESTA
POWER X TOOLS

BRUSHLESS **SHARE** **20V** *Li-ion technology*

Революции
0-550 min⁻¹
0-2000 min⁻¹

Маса
с батерия 2,0 Ah 1,8 кг
с батерия 4,0 Ah 2,1 кг

Вътящ момент
80 Nm

Патронник
2 – 13 mm



Брой в опаковка :
- Винтоверт
- батерия 2,0 Ah
- батерия 4,0 Ah
- зарядно 2,4 А
- допълнителна дръжка
- куфар



FESTA
POWER X TOOLS

АКУМУЛАТОРНА УДАРНА БОРМОШИНА

max 80 Nm		I.0-8800 об/мин II.0-32000 об/мин	I.0-550min ⁻¹ II.0-2000min ⁻¹			2-13 mm				1,4 kg		2x	
-----------	--	--------------------------------------	--	--	--	---------	--	--	--	--------	--	----	--

№ 28000 Размери

BRUSHLESS SHARE 20V Li-ion technology

Избор на режим/мощност на въртящ момент

Револуции
0-550 min⁻¹
0-2000 min⁻¹

Маса
с батерия 2,0 Ah 1,8 кг
с батерия 4,0 Ah 2,1 кг

Вътящ момент
80 Nm

Патронник
2 – 13 mm

Брой в опаковка :
- Винтоверт
- батерия 2,0 Ah
- зарядно 2,4 A
- допълнителна дръжка
- куфар



Допълнителна дръжка

Превключвател на скоростта

Бързо освобождаваща се патронник глава

превключвател за посока на въртене

Ергономична гумирана дръжка за безопасен захват

Лед осветление

Кука за закачане

Живот на батерията



АКУМУЛАТОРНА УДАРНА БОРМОШИНА



No 28001 Размери 2

BRUSHLESS SHARE 20V

Избор на режим/мощност на въртящ момент

Револуции
0-550 min⁻¹
0-2000 min⁻¹

Маса
без батерии
1,4 кг

Вътящ момент
80 Nm

Патронник
2 – 13 mm

Препоръчителни аксесоари

SHARE 20V Li-ion technology

2 Ah- 28080

батерия* 4 Ah- 28081

8 Ah- 28083

2,4 A- 28085

зарядно* 4,0 A- 28086

Допълнителна дръжка

Превключвател на скоростта

Бързо освобождаваща се патронник глава

превключвател за посока на въртене

Ергономична гумирана дръжка за безопасен захват

Лед осветление

Кука за закачане



АКУМУЛАТОРНА УДАРНА БОРМОШИНА



* Батерията не е включена в комплекта

No 28002 Размери 5

SHARE
20VLi-ion
technology

Революции
0-500 min⁻¹
0-1800 min⁻¹

Маса
с батерия 2,0 Ah
1,7 кг

Вътящ момент
45 Nm

Патронник
2 - 13 mm

Брой в опаковка :

- Винтоверт
- 2x батерия 2,0 Ah
- зарядно 2,4 A
- куфар
- Видове битове и бит :
 - ⊖ S5, S6 x 25 mm
 - ⊕ PH1, PH2 x 25 mm
 - * PZ1, PZ2 x 25 mm
- свредла HSS
2-2.5-3-4-5-6 mm

Избор на режим/мощност
на въртящ моментБързо освобождаваща
се патронник глава

Превключвател на скоростта

Ергономична гумирана дръжка
за безопасен захват

Лед осветление

Живот на батерията

превключвател
за посока на въртене

Кука за закачане

FESTA
POWER X TOOLS

АКУМУЛАТОРНА УДАРНА БОРМОШИНА

№
28003

Размери

3

SHARE
20V

Революции
0-550 min⁻¹
0-2000 min⁻¹

Маса
без батерии
1,4 кг

Вътящ момент
45 Nm

Патронник
2 - 13 mm

Препоръчителни аксесоари

SHARE
20V
Li-ion
technology

- батерия* 2 Ah - 28080
- батерия* 4 Ah - 28081
- батерия* 8 Ah - 28083
- зарядно* 2,4 A - 28085
- зарядно* 4,0 A - 28086

Избор на режим/мощност
на въртящ моментБързо освобождаваща
се патронник глава

Превключвател на скоростта

Ергономична гумирана дръжка за
безопасен захват

Лед осветление

превключвател
за посока на въртене

Кука за закачане

FESTA
POWER X TOOLS

АКУМУЛАТОРНА УДАРНА БОРМОШИНА



* Батерията не е включена в комплекта

№
28004

Размери

5

SHARE
20V *Li-ion*
technology

Револуции
0-350 min⁻¹
0-1300 min⁻¹

Маса
с батерия 2,0 Ah
1,3 кг

Вътящ момент
28 Nm

Патронник
1 – 10 mm

- Брой в опаковка :
- Винтоверт
 - 2x батерия 2,0 Ah
 - зарядно 2,4 A
 - куфар
 - Видове битове и бит :
 - ⊖ S5, S6 x 25 mm
 - ⊕ PH1, PH2 x 25 mm
 - ⊕ PZ1, PZ2 x 25 mm
 - свредла HSS
 - 1,5-2,5-3-4-5-6 mm



Избор на режим/мощност
на въртящ момент

Бързо освобождаваща
се патроник глава

Превключвател на скоростта

превключвател
за посока на
въртене

Ергономична.гумирана дръжка за
безопасен захват

Лед осветление

Кука за закачане

Живот на батерията



АКУМУЛАТОРНА БОРМАШИНА



№ 28005

Размери 3

SHARE
20V

Револуции
0-350 min⁻¹
0-1300 min⁻¹

Маса
без батерии
0,9 кг

Вътящ момент
28 Nm

Патронник
1 – 10 mm

Препоръчителни аксесоари

- батерия* 2 Ah- 28080
- 4 Ah- 28081
- 8 Ah- 28083
- зарядно* 2,4 A- 28085
- 4,0 A- 28086

Избор на режим/мощност
на въртящ момент

Бързо освобождаваща
се патроник глава

Превключвател на скоростта

превключвател за
посока на въртене

Ергономична.гумирана дръжка за
безопасен захват

Лед осветление

Кука за закачане



АКУМУЛАТОРНА БОРМАШИНА



* Батерията не е включена в комплекта

№ 28006



Размери 5

Li-ion
technology

Революции
0-350 min⁻¹
0-1300 min⁻¹

Маса
с батерия 1,5 Ah
1 кг

Вътящ момент
20 Nm

Патронник
1 - 10 mm

Брой в опаковка :

- Винтоверт
- 2x батерия 12 V / 1,5 Ah
- зарядно 12 V / 2,4 A
- куфар
- Видове битове и бит :
- ⊖ S5, S6 x 25 mm
- ⊕ PH1, PH2 x 25 mm
- ⊕ PZ1, PZ2 x 25 mm
- свредла HSS
1,5-2,5-3-4-5-6 mm



Избор на режим/мощност
на въртящ момент

Бързо освобождаваща
се патроник глава

Превключвател на скоростта

Лед осветление

Индикатор за зареждане
на батерията

превключвател за
посока на въртене

Ергономична, гумирана дръжка за
безопасен захват

батерия



FESTA
POWER X TOOLS

АКУМУЛАТОРНА БОРМАШИНА



№ 28007

Размери

5

Li-ion
technology

Революции
200 min⁻¹

Маса
с батерия 1,5 Ah
0,4 кг

Вътящ момент
3 Nm

Вид на
инструмента
1/4" hexagon

Брой в опаковка :

- Винтоверт
- зарядно 5 V / 0,5 A
- Видове бита :
- ⊖ S5 x 50 mm
- ⊕ PH1 x 50 mm
- ⊕ PH2 x 50 mm
- H5 x 50 mm
- ⊕ T20 x 50 mm

Бързо затягаща глава 1/4"
с предпазител

мощност на въртящ момент

Индикатор за зареждане
на батерията

Превключвател за дръжка

Лед осветление

превключвател за посока
на въртене

Ергономична, гумирана дръжка
за безопасен захват



Лед осветление

FESTA
POWER X TOOLS

АКУМУЛАТОРЕН ВИНТОВЕРТ



№ 28008

Размери

10

**SHARE
20V**

Револуции
0-2000 min⁻¹

Маса
без батерии
1,2 кг

Вътящ момент
150 Nm

Брой удари
0-3000 bpm

Бързо затягаща глава 1/4" с предпазител



Превключвател за посока на въртене

Ергономична, гумирана дръжка за безопасен захват

Лед осветление

Кука за закачане

**SHARE
20V
Li-ion
technology**

Препоръчителни аксесоари

батерия* 2 Ah- 28080
4 Ah- 28081
8 Ah- 28083

зарядно* 2,4 A- 28085
4,0 A- 28086



АКУМУЛАТОРЕН УДАРЕН ГАЙКОВЕРТ



* Батерията не е включена в комплекта

№	Размери
28021	



**SHARE
20V**

Револуции
**I.0-300 min⁻¹
II.0-1000 min⁻¹**

Маса
без батерии
1,7 кг

Брой удари
0-5000 bpm

Патронник
SDS+

ограничител за дълбочина

SDS глава за инструменти

Превключване на работен режим

Превключвател на скоростта

Превключвател за посока на въртене



**SHARE
20V
Li-ion
technology**

Препоръчителни аксесоари

батерия* 2 Ah- 28080
4 Ah- 28081
8 Ah- 28083

зарядно* 2,4 A- 28085
4,0 A- 28086



АКУМУЛАТОРНА УДАРНА БОРМОШИНА



* Батерията не е включена в комплекта

№	Размери
28025	



MAX Ø

бетон- Ø 20 mm
метали- Ø 10 mm
дърво- Ø 20 mm



**SHARE
20V**

Честота на запалване
60-100 min⁻¹

максимална дължина нокти / скоби
30 mm
Твърди материали





Максимална дължина на пириони/щипки
50 mm
Меки материали

Маса без батерии
2,7 кг



**SHARE
20V
Li-ion
technology**

Препоръчителни аксесоари

- батерия* 2 Ah- 28080 
- батерия* 4 Ah- 28081 
- батерия* 8 Ah- 28083 
- зарядно* 2,4 A- 28085 
- зарядно* 4,0 A- 28086 

Пириони

- 23930** Пирон за забиване 30 mm, 2000 кука
- 23931** Пирон за забиване 40 mm, 2000 кука
- 23932** Пирон за забиване 50 mm, 2000 кука

Катарами

- 23935** Закопчаваща се катарама 30 mm, 2000 кука
- 23936** Закопчаваща се катарама 40 mm, 2000 кука

Подходящи видове на пириони и щипки :

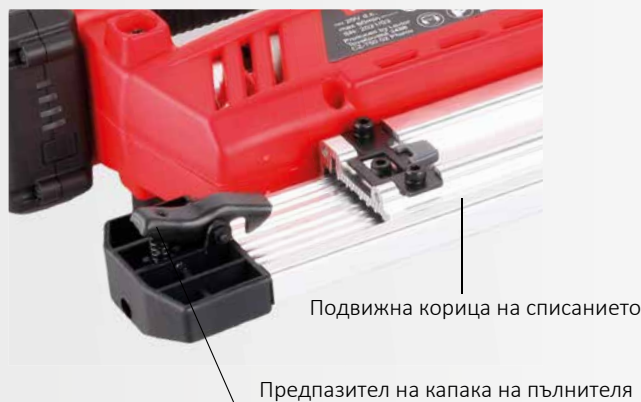
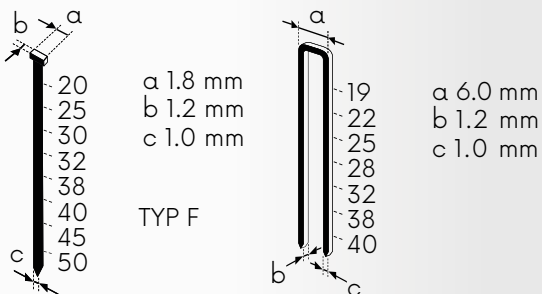

АКУМУЛАТОРЕН ЗАБИВАЧ

max 60 min⁻¹

TYPE F

LED

2,7 KG

* Батерията не е включена в комплекта

№	Размери
28070	



BRUSHLESS SHARE 20V

Револуции **8500 min⁻¹**

Маса без батерии **1,6 кг**

Максимална дебелина на рязания материал **15 mm**

Максимален диаметър на диска **125 mm**

Вентилационни отвори на двигателя

Ергономична гумирана дръжка за безопасен захват

Спиране на въртенето

Предпазител на работния превключвател

Механизъм за бързо освобождаване на защитния капак

Затягаща гайка на диска



SHARE 20V
Li-ion technology

Препоръчителни аксесоари

- батерия* 2 Ah- 28080
- батерия* 4 Ah- 28081
- батерия* 8 Ah- 28083
- зарядно* 2,4 A- 28085
- зарядно* 4,0 A- 28086

FESTA
POWER X TOOLS

АКУМУЛАТОРЕН ШЛАЙФ

8500 min ⁻¹	max 125mm	M14	L R	1,6 kg
------------------------	--------------	-----	-----	--------

* Батерията, диск не е включена в комплекта

№ 28030



4

SHARE 20V

Револуции **8000 min⁻¹**

Маса без батерии **1,6 кг**

Максимална дебелина на рязания материал **15 mm**

Максимален диаметър на диска **115 mm**

Ергономична гумирана дръжка за безопасен захват

Спиране на въртенето

Предпазител на работния превключвател

Механизъм за бързо освобождаване на защитния капак

Затягаща гайка на диска



SHARE 20V
Li-ion technology

Препоръчителни аксесоари

- батерия* 2 Ah- 28080
- батерия* 4 Ah- 28081
- батерия* 8 Ah- 28083
- зарядно* 2,4 A- 28085
- зарядно* 4,0 A- 28086

FESTA
POWER X TOOLS

АКУМУЛАТОРЕН ШЛАЙФ

8000 min ⁻¹	max 115mm	M14	L R	1,6 kg
------------------------	--------------	-----	-----	--------

* Батерията, диск не е включена в комплекта

№ 28032



4

SHARE 20V

Револуции
10000 min⁻¹

Маса
без батерии
1 кг

Диаметър
на диска
125 mm

Ексцентричност
на диска
5 mm

превключвател





Торба за събиране на прах

Вградено засмукване

Носещ диск с велкро

SHARE 20V Li-ion technology

Препоръчителни аксесоари

	2 Ah- 28080	
батерия*	4 Ah- 28081	
	8 Ah- 28083	
	2,4 A- 28085	
зарядно*	4,0 A- 28086	

FESTA
POWER X TOOLS

АКУМУЛАТОРЕН ЕКСЦЕНТРИК ШЛАЙФ



* Батерията не е включена в комплекта

№ 28040
Размери



SHARE 20V

Брой трептения без
натоварване
5000-15000 min⁻¹

Маса
без батерии
1 кг

Контрол
на скоростта



Щифт за закрепване
на инструменти



Лост за смяна и заключване
на инструмента

Контрол на скоростта

Ергономична, гумирана дръжка за
безопасен захват

SHARE 20V Li-ion technology

Препоръчителни аксесоари

	2 Ah- 28080	
батерия*	4 Ah- 28081	
	8 Ah- 28083	
	2,4 A- 28085	
зарядно*	4,0 A- 28086	

FESTA
POWER X TOOLS

МНОГОФУНКЦИОНЕЛЕН АКУМУЛАТОРЕН ШЛАЙФ



* Батерията не е включена в комплекта

№ 28045
Размери



SHARE
20V

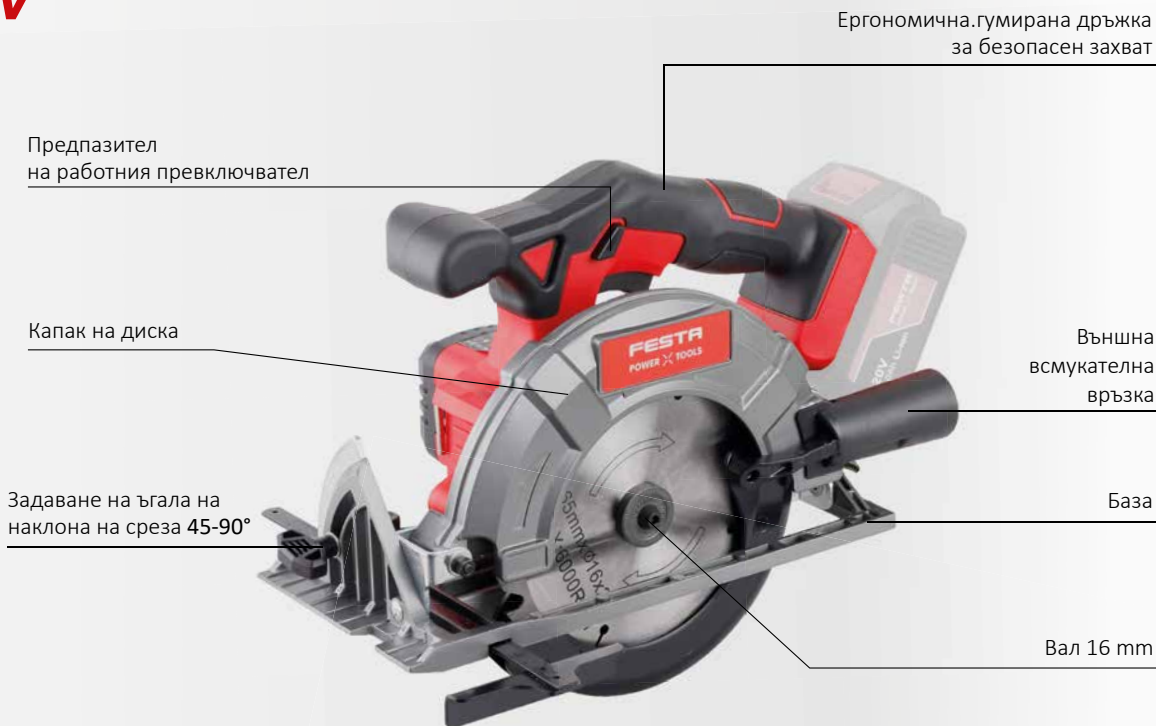

Обороти без товар
3650 min⁻¹

Задаване на ъгала на наклона на среза
45-90°





Максимален диаметър на диска
165 mm
(ø16 mm)

Максимално напречно сечение
50 mm
* 90°, диск ø165 mm



SHARE
20V
Li-ion
technology

Препоръчителни аксесоари

- | | | |
|----------|--------------|---|
| | 2 Ah- 28080 |  |
| батерия* | 4 Ah- 28081 |  |
| | 8 Ah- 28083 |  |
| зарядно* | 2,4 A- 28085 |  |
| | 4,0 A- 28086 |  |

FESTA
POWER X TOOLS

АКУМУЛАТОРЕН ЦИРКУЛЯР

Комплектът съдържа:

- циркулярен трион
- страничен водач
- гаечен ключ
- трион ø 165 x 2,8/2,0 x 20 mm 24T (22314)

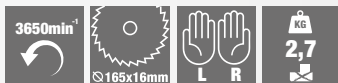

№ 28035 Размери



**SHARE
20V**

Броя на ходовете на острието
0-2400 min⁻¹

Маса без батерии
1,8 кг

Максимален ъгъл на скосяване на среза
45°

Максимален профил на рязане
**Стомана : 6 mm
Дърво : 80 mm**

Препоръчителни аксесоари

- 2 Ah- 28080
- батерия* 4 Ah- 28081
- 8 Ah- 28083
- 2,4 A- 28085
- зарядно* 4,0 A- 28086

Предпазител на работния превключвател

Настройка на предварително трептене

Лед осветление

Защитна лента

Направляваща релса

Ергономична, гумирана дръжка за безопасен захват

Лост за заключване на наклона

База

Скосяване на среза



**SHARE
20V
Li-ion
technology**



АКУМУЛАТОРЕН ЛИНЕЕН ТРИОН



* Батерията не е включена в комплекта

№ 28050
Размери



**SHARE
20V**

Броя на ходовете на острието
0-3000 min⁻¹

Маса без батерии
1,7 кг

Максимален профил на рязане
**Дърво: 100 mm
Стомана: 5 mm
алуминий/мед: 20 mm**

Препоръчителни аксесоари

- 2 Ah- 28080
- батерия* 4 Ah- 28081
- 8 Ah- 28083
- 2,4 A- 28085
- зарядно* 4,0 A- 28086

Предпазител на работния превключвател

Ергономична, гумирана дръжка за безопасен захват

Бързозатягащ се нож

**SHARE
20V
Li-ion
technology**



АКУМУЛАТОРЕН ТРИОН



* Батерията не е включена в комплекта

№ 28055
Размери



SHARE
20V

макс. налягане
8,2 bar

манометър
**psi, bar,
kgf/cm², kPa**

маркуч
600 mm

волтаж
20 V

осветен манометър
дисплей



Ергономична,
гумирана дръжка
за безопасен захват

бързо
освобождаващ
се патронник за
автомобилни гуми

адаптер за автомобилен
акумулатор 3 м



адаптери

- Комплектът съдържа:
- компресор
 - адаптер за захранване от акумулатора на автомобила
 - 3x адаптери за надуване



маркуч
Ø 10,5 x 600 mm

LED светлина



SHARE
20V
*Li-ion
technology*

Препоръчителни аксесоари

- | | | |
|----------|--------------|---|
| батерия* | 2 Ah- 28080 |  |
| | 4 Ah- 28081 | |
| | 8 Ah- 28083 | |
| зарядно* | 2,4 A- 28085 |  |
| | 4,0 A- 28086 | |



КОМПРЕСОР ЗА ВЪЗДУХ

* Батерията не е включена в комплекта

№	Размери
28075	
48013 NEW	адаптери



1
1



NEW

Хоризонтална
110 kg

Вертикална
80 kg

Ø 220 mm

USB-C



ВАКУУМНА ВЕНДУЗА

Ø 220 mm	80 kg	110 kg	ROUGH SURFACE	USB-C	Li-ion 3.6V 2Ah
----------	-------	--------	---------------	-------	--------------------

№ 36326 Размери



SHARE 20V

товароносимост
60 кг

тегло
3 кг

вibration
**12 нива на регулиране,
3500 - 8500 r/min**

волтаж
20 V

Ергономична,
гумирана дръжка
за безопасен захват



светещ дисплей



заклучващ лост за вендуза



вендуза Ø 125 mm



ВИБРАТОР ЗА ПЛОЧКИ



Препоръчителни аксесоари

- 2 Ah- 28080
- батерия* 4 Ah- 28081
- 8 Ah- 28083
- зарядно* 2,4 A- 28085
- 4,0 A- 28086

- Комплектът съдържа:
- вибратор за плочки
 - батерия 2,0 Ah (само 36328)
 - зарядно (само 36328)
 - случай

№	Размери	
36328	с батерия 2Ah и зарядно	1
36329	без батерия и зарядно	1



SHARE
20V

регулируема скорост
0-8,7 mm/s

тегло
1,7 кг

врътящ момент
6500 N

волтаж
20 V

вместимост 310 мл



Ергономична,
гумирана дръжка
за безопасен захват

спусък с променлива
скорост

LED светлина



SHARE
20V
Li-ion
technology

Препоръчителни аксесоари

2 Ah- 28080

батерия* 4 Ah- 28081

8 Ah- 28083

зарядно* 2,4 A- 28085

4,0 A- 28086



ПИСТОЛЕТ ЗА УПЛЪТНЯВАНЕ

* Батерията не е включена в комплекта

№	Размери
28060	



1



600 ml



РЕЗЕРВНА КАСЕТА ЗА УПЛЪТНИТЕЛ

· 28060

№	Размери
28061	600 ml



1

SHARE
20V

Цветна температура
5000 K

Маса
без батерии
0,9 кг

Светлинен поток
2000 lm (100%)

Лед светлина
20 W

SHARE
20V
Li-ion
technology

Препоръчителни аксесоари

2 Ah- 28080

батерия* 4 Ah- 28081

8 Ah- 28083

зарядно* 2,4 A- 28085

4,0 A- 28086



Настройка на интензивността на осветлението
50%, 100%



360° Настройка на въртяща се глава



АКУМУЛАТОРЕН ЛЕД СВЕТЛИНА



* Батерията не е включена в комплекта

№	Размери
28065	



2

**SHARE
20V**

тuner
DAB+ / FM / BT

мощност
2x 15 W

водоустойчивост
IP54

волтаж
20 V



USB за зареждане 5V



SHARE
20V
захранване



FM антена



цветен дисплей

Препоръчителни аксесоари

**SHARE
20V
Li-ion
technology**

батерия*	2 Ah- 28080	
	4 Ah- 28081	
	8 Ah- 28083	
зарядно*	2,4 A- 28085	
	4,0 A- 28086	

AUX IN 3,5 mm



стерео говорители

захранване- адаптер 230V



**FESTA
POWER X TOOLS**

РАДИО DAB+ / FM / BT

- стерео
- DAB+ / FM
- външен вход Bluetooth V5.0 / AUX IN 3.5 mm
- устойчивост на проникване на вода IP54
- 30 предварително зададени памет (30 за DAB / 30 за FM)
- USB за зареждане
- 2,4" цветен дисплей
- мощност 2x 15 W
- 20 V / 1,3 A
- захранващ адаптер

* Батерията не е включена в комплекта

№ 28076 Размери



SHARE
20V



ЗАРЯДНО ФЕСТА 20 V / 2,4 A

№	Размери
28085	220 – 240 V, 50 – 60 Hz, 70 W



SHARE
20V



ЗАРЯДНО ФЕСТА 20 V / 4,0 A

№	Размери
28086	220 – 240 V, 50 – 60 Hz, 105 W



SHARE *Li-ion technology*
20V



Индикатор за зареждане на батерията



БАТЕРИЯ 20 V / 2,0 АН

20V	2,0 Ah	Li-ion	0,4
-----	--------	--------	-----

№	Размери
28080	



SHARE *Li-ion technology*
20V



Индикатор за зареждане на батерията



БАТЕРИЯ 20 V / 4,0 АН

20V	4,0 Ah	Li-ion	0,7
-----	--------	--------	-----

№	Размери
28081	



SHARE *Li-ion technology*
20V



Индикатор за зареждане на батерията



БАТЕРИЯ 20 V / 8,0 АН

20V	8,0 Ah	Li-ion	1,0
-----	--------	--------	-----

№	Размери
28083	



SHARE
20V *Li-ion*
technology

28080



28085



Намалена
Цена

FESTA
POWER X TOOLS

КОМПЛЕКТ С БАТЕРИЯ И ЧАНТА 2 + 3

28080 - Батерия за акумулаторни инструменти Феста 20 V / 2,0 Ah
28085 - Зарядно Феста 20 V / 2,4 A

№ 28090
Размери



1

SHARE
20V *Li-ion*
technology

28004
Страница 6



28025
Страница 9



37330



28030
Страница 12



BRUSHLESS

Безплатна
чанта с
намалена
Цена

FESTA
POWER X TOOLS

КОМПЛЕКТ С БАТЕРИЯ И ЧАНТА 3 + 3

28004 - Акумулаторен перфоратор Феста 20 V
28025 - Акумулаторен перфоратор Феста SDS+ 20 V
28030 - Акумулаторен ъглошлайф „BRUSHLESS“ Феста 20 V / 125 мм
28080 - Батерия за акумулаторни инструменти Феста 20 V / 2,0 Ah
28081 - Батерия за акумулаторни инструменти Феста 20 V / 4,0 Ah
28086 - Зарядно Феста 20 V / 4,0 A

28080
Страница 18



28081
Страница 18



28086
Страница 18



№ 28102
Размери



1

BRUSHLESS **SHARE**
20V *Li-ion*
technology

28002
Страница 5



37330



28030
Страница 12

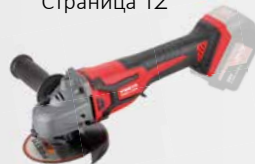

Безплатна
чанта с
намалена
Цена

FESTA
POWER X TOOLS

КОМПЛЕКТ С БАТЕРИЯ И ЧАНТА 2 + 3

28002 - Акумулаторен перфоратор „BRUSHLESS“ Феста 20 V
28030 - Акумулаторен ъглошлайф „BRUSHLESS“ Феста 20 V / 125 мм
28080 - Батерия за акумулаторни инструменти Феста 20 V / 2,0 Ah
28081 - Батерия за акумулаторни инструменти Феста 20 V / 4,0 Ah
28086 - Зарядно Феста 20 V / 4,0 A

28080
Страница 18



28081
Страница 18



28086
Страница 18



№ 28103
Размери



1

SHARE
20V

Li-ion
technology

28004
Страница 6

28032
Страница 12

28055
Страница 15

Безплатна
чанта с
намалена
цена

28035
Страница 14

37330

28040
Страница 13

FESTA
POWER X TOOLS

КОМПЛЕКТ С БАТЕРИЯ И ЧАНТА 5 + 3

- 28004 - Акумулаторен перфоратор Феста 20 V
- 28032 - Акумулаторен ъглошлайф Феста 20 V / 115 мм
- 28035 - Акумулаторен циркуляр Феста 20 V / 165мм / d 16мм
- 28040 - Акумулаторен ексцентрик шлайф феста 20 V / 125 мм / 8 отвора
- 28055 - Акумулаторен верижен трион Феста 20 V
- 28080 - Батерия за акумулаторни инструменти Феста 20 V / 2,0 Ah
- 28081 - Батерия за акумулаторни инструменти Феста 20 V / 4,0 Ah
- 28086 - Зарядно Феста 20 V / 4,0 A



28080
Страница 18



28081
Страница 18



28086
Страница 18



№ Размери

28101



1

SHARE
20V

Li-ion
technology

BRUSHLESS

28002
Страница 5

28030
Страница 12

Безплатна
чанта с
намалена
цена

28040
Страница 13

BRUSHLESS

37330

28055
Страница 15

28035
Страница 14

FESTA
POWER X TOOLS

КОМПЛЕКТ БАТЕРИЯ С ЧАНТА 5 + 3

- 28002 - Акумулаторен перфоратор „BRUSHLESS“ Феста 20 V
- 28030 - Акумулаторен ъглошлайф „BRUSHLESS“ Феста 20 V / 125 мм
- 28035 - Акумулаторен циркуляр Феста 20 V / 165мм / d 16мм
- 28040 - Акумулаторен ексцентрик шлайф феста 20 V / 125 мм / 8 отвора
- 28055 - Акумулаторен верижен трион Феста 20 V
- 28080 - Батерия за акумулаторни инструменти Феста 20 V / 2,0 Ah
- 28081 - Батерия за акумулаторни инструменти Феста 20 V / 4,0 Ah
- 28086 - Зарядно Феста 20 V / 4,0 A

28080
Страница 18



28081
Страница 18



28086
Страница 18



№ Размери

28104



1











BRUSHLESS

Инструмента се задвижва
безчетков DC двигател

Въртящ момент	
Революции	
Посока на въртене	
Патронник	
Пробиване ударно/завинтване	
Брой удари в минута	
Пробиване/завинтване	
Тегло с/без батерия	
Метод на закрепване	
Метод на закрепване	
Метод на закрепване	
Ексцентричност на диска	
Управление на устройството за дясна/лява ръка	
Отговаря на определения стандарт	
Светлинен поток	
Ъгъл на насочване на светлина	
Максимална честота на запалване	

**SHARE
20V**

Инструмента е съвместим
с две батерии

	Подходящи видове пирони
	Подходящи видове клипси
	Шлифовъчно колело с отвори Ø125mm
	Диаметър на диска 115 mm
	Диаметър на диска 165x16mm
	Максимална дебелина на рязане на материал дърво 80mm
	Максимална дебелина на рязане на материал стомана 6mm
	Бързозатягащи триони
	Приставка за трион
	Броя на ударите на триона 0-2400 rpm
	Настройка на предварително трепене
	Бързозатягащ се нож
	Брой трептения на триона 0-3000 rpm
	Лед осветление
	Капацитет на батерия 2,0 Ah
	Батерия Li-ion
	Време за зареждане на батерията 45 min

NEW

революции
520 min⁻¹

ВРМ / удар
0 - 4100 / 12 J

мощност
1500 W

глава за инструменти
SDS MAX



MAX \emptyset бетон- \emptyset 40 mm



ограничител за дълбочина

система за намаляване на вибрациите



прахоуловител

SDS MAX патронник

Ергономична, гумирана дръжка за безопасен захват



допълнителна дръжка

3.0m

FESTA
POWER X TOOLS

УДАРНА БОРМОШИНА SDS MAX

Комплектът съдържа:

- ударна бормашина
- странична дръжка
- дълбокомер
- прахоуловител
- гаечен ключ
- пластмасова кутия
- резервни въгленови четки
- аксесоари SDS MAX:

\emptyset 16 x 280 mm
| 18 x 320 mm

резервни карбонови четки 2 бр - 28229



FESTA
POWER X TOOLS

№ 28221

Характеристики

революции
0-850 min⁻¹

BPM / удар
0-4500 / 6 J

мощност
1500 W

глава за
инструменти
SDS+



MAX ø

бетон- ø 32 mm
метали- ø 13 mm
дърво- ø 40 mm



ограничител за
дълбочина

система за намаляване
на вибрациите

SDS+
патронник

Ергономична,
гумирана дръжка
за безопасен захват

допълнителна дръжка



2.0m

FESTA
POWER X TOOLS

УДАРНА БОРМОШИНА

Комплектът съдържа:

- ударна бормашина
- странична дръжка
- дълбокомер
- гаечен ключ
- пластмасова кутия
- резервни въгленови четки
- аксесоари SDS+:

- ⚡ ø 8, 10, 12 x 160 mm
- 🔧 20 x 250 mm
- 📏 14 x 250 mm



230V ~ 50Hz	1500W	0-4500 bpm	0-850 min ⁻¹	6J	SDS+	2m RUBBER	5.0
----------------	-------	------------	-------------------------	----	------	-----------	-----

резервни карбонови четки 2 бр - 28228



революции
0-1350 min⁻¹

BPM / удар
0-5500 / 2,8 J

мощност
800 W

глава за инструменти
SDS+

Ø 2 - 13 mm



MAX Ø

бетон- Ø 25 mm
метали- Ø 13 mm
дърво- Ø 30 mm

SDS+ патронник

механизъм за бърза смяна на патронника

превключвател за посока на въртене

ограничител за дълбочина



Ергономична, гумирана дръжка за безопасен захват

Допълнителна дръжка

2.0m

SDS+

Ø 2- 13 mm

FESTA
POWER X TOOLS

УДАРНА БОРМОШИНА

Комплектът съдържа:

- ударна бормашина
- странична дръжка
- дълбокомер
- патронник Ø 2- 13 mm
- пластмасова кутия
- вазелин
- резервни въгленови четки
- аксесоари SDS+:

⚡ Ø 6, 8, 10 x 160 mm

🔧 20 x 250 mm

📏 14 x 250 mm

230V
~ 50Hz

800W



0-1350 min⁻¹

2.8J

SDS+

2m RUBBER

3.2 KG

резервни карбонови четки 2 бр - 28223



№ 28220

Характеристики

Обороти без товар
0-4500 min⁻¹

тегло
4,3 кг

Мощност
1400 W

Максимален
диаметър на диска
max ø 185 mm / ø 20 mm



Ергономична,
гумирана дръжка
за безопасен захват



Направляваща релса
6- 120 mm



FESTA
POWER X TOOLS

ЦИРКУЛЯР

- Комплектът съдържа:
- циркулярен трион
 - страничен водач
 - гаечен ключ
 - резервни въгленови четки
 - трион ø 185 x 2,3/1,3 x 20 mm 24T (22316)



резервни карбонови
четки 2 бр - 28233



1400W	230V ~ 50Hz	4500 min⁻¹	ø 20 1 mm MAX 185 mm	90° 63 mm	45° 42 mm	KG 4.3
--------------	-----------------------	------------------------------	----------------------------	--------------	--------------	-------------------------

№ 28230 Характеристики



Революции
6600 min⁻¹
 тегло
5,8 kg
 Мощност
2400 W
 Максимален
 диаметър на диска
M14
max Ø 230 mm



Ергономична гумирана дръжка за безопасен захват

SOFT START

плавен старт



Капак на защитния диск

въртяща се дръжка



FESTA
POWER X TOOLS

ШЛАЙФ

Комплектът съдържа:

- шлайф
- капак на защитния диск
- странична дръжка
- гаечен ключ
- резервни въгленови четки

2400W	230V ~ 50Hz	6600 min⁻¹ SOFT START	M14	max Ø 230mm	2.0m RUBBER	5.8 KG	
--------------	-----------------------	--	------------	--------------------	-----------------------	------------------	--

резервни карбонови четки 2 бр - 28218



№ 28215 Характеристики

Революции
11000 min⁻¹

тегло
2 kg

Мощност
900 W

Максимален
диаметър на диска
M14
max Ø 125 mm

Допълнителна дръжка



Предпазител на работния превключвател

SOFT START

плавен старт



Капак на защитния диск

3,0m

FESTA
POWER X TOOLS

ШЛАЙФ

Комплектът съдържа:

- шлайф
- капак на защитния диск
- странична дръжка
- гаечен ключ
- резервни въгленови четки

900W	230V ~ 50Hz	11000min⁻¹	M14	max Ø 125mm	2.0m RUBBER	KG 2.0				
-------------	-----------------------	------------------------------	------------	--------------------	--------------------	---------------	--	--	--	--

резервни карбонови четки 2 бр - **28213**



№ 28210
Характеристики

8

FESTA
POWER X TOOLS

РЕЗЕРВНИ ВЪГЛЕНОВИ ЧЕТКИ

2x



№	Характеристики	
28229	за 28221	1
28228	за 28225	1
28223	за 28220	1
28233	за 28230	1
28213	за 28210	1
28218	за 28215	1



АДАПТЕР ОТ SDS MAX НА SDS

	→			
№	Характеристики			
20744			1	



АДАПТЕР SDS +

№	Характеристики		
20745			1



FESTA

АДАПТЕР ОТ SDS + БИТ 1/4"

	→				
№	Характеристики				
20743	75 mm		20		



FESTA

ПАТРОННИК ЗА БОРМАШИНА

№	Характеристики		
20960	1-13 mm + 2 klíče, 1/2 - 20 UNF		3
20966	Резервен ключ		25



FESTA

ПАТРОННИК ЗА БОРМАШИНА, САМОЗАТЯГАЩ

№	Характеристики		
20965	1,5 - 13 mm 1/2' - 20 UNF		1



ПАТРОННИК ЗА БОРМАШИНА, САМОЗАТЯГАЩ

№	Характеристики		
20961	1,5 - 13 mm 1/2' - 20 UNF		1



АДАПТЕР ЗА БОРМАШИНА, 90°

№	Характеристики		
20365	Ø 1 - 10 mm		10



ПАТРОННИК ЗА БОРМАШИНА, САМОЗАТЯГАЩ

№	Характеристики		
20963	Ø 1 - 6 mm		10



FESTA

ПРАХОУЛОВИТЕЛ

№	Характеристики		
28267	max. 70 mm		1

ВОДАЧ ЗА СВРЕДЛО

№	Характеристики		
20379	Ø 4, 5, 6, 7, 8, 10, 12 mm		10

ТЕХНИЧЕСКА
СПЕСИФИКАЦИЯ

Каталожен номер на продукт	28000	28001	28002	28003	28004
Име	Акумулаторна ударна бормошина	Акумулаторна ударна бормошина	Акумулаторна ударна бормошина	Акумулаторна ударна бормошина	Акумулаторна ударна бормошина
Обороти без натоварване	I.0-550 min ⁻¹ II.0-2000 min ⁻¹	I.0-550 min ⁻¹ II.0-2000 min ⁻¹	I.0-550 min ⁻¹ II.0-2000 min ⁻¹	I.0-500 min ⁻¹ II.0-1800 min ⁻¹	I.0-500 min ⁻¹ II.0-1800 min ⁻¹
Брой вибрации със натоварване	I.0-8800min ⁻¹ II.0-32000min ⁻¹	I.0-8800min ⁻¹ II.0-32000min ⁻¹	I.0-8800min ⁻¹ II.0-32000min ⁻¹	0-19200 min ⁻¹	0-19200 min ⁻¹
Брой удари					
Въртящ момент	80 Nm	80 Nm	80 Nm	45 Nm	45 Nm
Макс. напрежение на батерията	20V	20V	20V	20V	20V
Брой вътящ момент	20+1+1	20+1+1	20+1+1	19+1+1	19+1+1
Затягаща гайка	2-13 mm	2-13 mm	2-13 mm	2-13 mm	2-13 mm
Тегло без батерия	1,4kg	1,4kg	1,4kg	1,3kg	1,3kg
Претпазител	IPX0	IPX0	IPX0	IPX0	IPX0
Ниво на шум несигурност К	LpA=97,04dB(A) K=5dB(A)	LpA=97,04dB(A) K=5dB(A)	LpA=97,04dB(A) K=5dB(A)	LpA=79dB(A) K=5dB(A)	LpA=79dB(A) K=5dB(A)
Максимален шум на работа несигурност К	LwA=86,04dB(A) K=5dB(A)	LwA=86,04dB(A) K=5dB(A)	LwA=86,04dB(A) K=5dB(A)	LwA=90dB(A) K=5dB(A)	LwA=90dB(A) K=5dB(A)
Вибрация без удар за пробиване на метал	a _{h,d} =3,9m/s ² K=1,5m/s ²	a _{h,d} =3,9m/s ² K=1,5m/s ²	a _{h,d} =3,9m/s ² K=1,5m/s ²	a _{h,d} =2,4m/s ² K=1,5m/s ²	a _{h,d} =2,4m/s ² K=1,5m/s ²
Вибрация без удар на бетон	a _{h,id} =11,4m/s ² K=1,5m/s ²	a _{h,id} =11,4m/s ² K=1,5m/s ²	a _{h,id} =11,4m/s ² K=1,5m/s ²	a _{h,id} =7,5m/s ² K=1,5m/s ²	a _{h,id} =7,5m/s ² K=1,5m/s ²
Максимална вибрация на несигурност К					
Ударна сила					
Диаметър на отвора					
Вибрация при работа с бетон					
Вибрация при работа с бетон					
Брой в кутия	Винтоверт, зарядно 2,4, батерия 2,0А, батерия 4.0А, допълнителна дръжка и куфар	Винтоверт, зарядно 2,4А, батерия 2,0А, куфар	Винтоверт	Винтоверт, зарядно 2,4А, батерия 2x2,0АН 6БР бит, 6бр свредла, куфар	Винтоверт



28005	28006	28007	28008	28021	28025
Акумулаторна бормашина	Акумулаторна бормашина	Акумулаторна бормашина	Акумулаторен винтоверт	Акумулаторен ударен гайковерт	Акумулаторна ударна бормашина
I.0-350 min ⁻¹ II.0-1300 min ⁻¹	I.0-350 min ⁻¹ II.0-1300 min ⁻¹	I.0-350 min ⁻¹ II.0-1300 min ⁻¹	200 min ⁻¹	0-2000 min ⁻¹	I.0-300 min ⁻¹ II.0-1000 min ⁻¹
					0-5000bpm
				0-3000bpm	
28 Nm	28 Nm	20 Nm	3 Nm	150 Nm	
20V	20V	12V	3.6V	20V	20V
19+1	19+1	19+1	6+1		
1-10mm	1-10mm	1-10mm	1/4" hexagon	1/4" hexagon	SDS+
0,9kg	0,9kg	*1kg	*0,4kg	1,2kg	1,7kg
IPX0	IPX0	IPX0	IPX0	IPX0	IPX0
LpA=69dB(A) K=5dB(A)	LpA=69dB(A) K=5dB(A)	LpA=78dB(A) K=5dB(A)	LpA=58dB(A) K=3dB(A)	LpA=92dB(A) K=3dB(A)	LpA=82,98dB(A) K=3dB(A)
LwA=80dB(A) K=5dB(A)	LwA=80dB(A) K=5dB(A)	LwA=67dB(A) K=5dB(A)	LwA=69dB(A) K=3dB(A)	LwA=103dB(A) K=3dB(A)	LwA=93,98dB(A) K=3dB(A)
a _{h,d} < 1,9m/s ² K=1,5m/s ²	a _{h,d} < 1,9m/s ² K=1,5m/s ²	a _{h,d} = 2,1m/s ² K=1,5m/s ²			
a _{h,10} = 10,1m/s ² K=1,5m/s ²	a _{h,10} = 10,1m/s ² K=1,5m/s ²	a _{h,10} = 7,5m/s ² K=1,5m/s ²			
			a _h < 2,5m/s ² K=1,5m/s ²	a _{h,d} = 15,9m/s ² K=1,5m/s ²	
					1,2J
					Стомана: 10mm БЕТОН: 20mm Дърво: 20mm
					a _{h,(HD)} = 5,582m/s ² K=1,5m/s ²
					a _{h,(HD)} = 5,523m/s ² K=1,5m/s ²
Винтоверт зарядно 2.4А, 2x батерии 2,0Аh, 6бита, 6 свредла, куфар	Винтоверт	Винтоверт зарядно 2,4А, 2x батерии 1,5Аh 6бита.6 свредла, куфар	Акумулаторна отвертка зарядно 0.5А, батерия 1.5Аh 5 бита	tightener	Акумулаторен перфоратор. допълнителна дръжка. ограничител за дълбочина

* Тегло с батерия

ТЕХНИЧЕСКА СПЕСИФИКАЦИЯ



Наталожен номер на продукт	28030	28032	28035	28040
Име	Акумулаторен шлайф	Акумулаторен шлайф	Акумулаторен циркуляр	Акумулаторен ексцентрик шлайф
Обороти без натоварване	8500 min ⁻¹	8000 min ⁻¹	3650 min ⁻¹	10000 min ⁻¹
Брой вибрации без натоварване				
Предварителна вибрация				
Брой позиции				
Брой задвижвания				
Максимална дебелина на материала				
Максимален размер на диска	125 mm	115 mm		
Носеща гайка				125 mm
Осем всмукателни отвора				65 mm
Ексцентричен гайка				5 mm
Размер на захващаш болт	M14	M14		
Максимална дебелина на материала	15 mm	15 mm		
Максимално напрежение на батерията	20V	20V	20V	20V
Нагласяне на режещ ъгъл			0-45°	
Разрез при ъгъл 45°			35 mm	
Разрез при ъгъл 90°			50 mm	
Ъгъл на трептене				
Размер на работна основа				
Регулиране скоростта на въртене				
Регулиране скоростта на въртене				
Захващане на режещ трион				
Размер база			28 cm x 13,3 cm	
Тегло без батерия	1,6kg	1,6kg	2,7kg	1kg
Размер на диска			165 mm	
Дебелина на диска			1,4 mm ± 5% mm	
Дебелина на SK диск			2,0 ± 5% mm	
Ширина на разрез			2,3 ± 5% mm	
Максимален диаметър на диска			16 mm	
Брой зъби на диска			24	
Предпазител	IPX0	IPX0	IPX0	IPX0
Пирони-тип. височина x ширина и дебелина				
Скоби-височина. ширина. дебелина				
Макс. дължина на пирони/скоби за мек материал				
Макс. дължина на пирона/скоби за твърд материал				
Максимална ударна мощ				
Време за работа на батерия 4AH. заредена				
Капацитет на пълнителя за пирони/скоби				
Ниво на шум Несигурност K	LpA=87,1dB(A) K=3dB(A)	LpA=76,67dB(A) K=3dB(A)	LpA=84dB(A) K=3dB(A)	LpA=76dB(A) K=3dB(A)
Ниво на шум при работа Несигурност K	LwA=98,1dB(A) K=3dB(A)	LwA=87,67dB(A) K=3dB(A)	LwA=95dB(A) K=3dB(A)	LwA=87dB(A) K=3dB(A)
Вибрация при работа	a _{h,AG} =8,363m/s ² K=1,5m/s ²	a _{h,AG} =5,324m/s ² K=1,5m/s ²		
Вибрация при режещ диск				
Вибрация при рязане на метал				
Вибрация при рязане на дърво				
Максимални вибрации несигурност K			a _h <2,5m/s ² K=1,5m/s ²	a _h =9,5m/s ² K=1,5m/s ²
Брой в опаковка	Ъглошлайф, предпазител, допълнителна дръжка, ключ	Ъглошлайф, предпазител, допълнителна дръжка, ключ	Трион дълбочинен ограничител за трион	Шлайф машина и торбичка за прах

28045	28050	28055	28070
Многофункционален акумулаторен шлайф	Акумулаторен линеен трион	Акумулаторен трион	Забивач / Такер
5000-15000 min ⁻¹		0-3000 min ⁻¹	
	3+0	1°	
	0-2400 min ⁻¹		
	Стомана: 6mm, Дърво: 80mm	Дърво: 100 mm, Стомана: 5 mm, алуминий/мед: 20 mm	
20V		20V	20V
	Макс. ъгъл на скосяване на среза 45 °		
3°			
90 mm			
YES			
universal		universal	
		20 mm	
1kg	1,8kg	1,7kg	2,7kg
IPX0	IPX0	IPX0	IPX0
			F, 20-50mm x 1,2mm x 1,0 mm
			6,0mm x 19-40mm x 1,2mm x 1,0mm
			50 mm
			30 mm
			60/100 min ⁻¹
			1 часовник
			100 брой
LpA=78dB(A) K=3dB(A)	LpA=88,1dB(A) K=5dB(A)	LpA=87,33dB(A) K=5dB(A)	LpA=79,9dB(A) K=3dB(A)
LwA=89dB(A) K=3dB(A)	LwA=99,1dB(A) K=5dB(A)	LwA=98,33dB(A) K=5dB(A)	LwA=90,9dB(A) K=3dB(A)
	a _{h,B} =3,3m/s ² K=1,5m/s ²	a _{h,B} =21,10m/s ² K=1,5m/s ²	
	a _{h,M} =4m/s ² K=1,5m/s ²		
		a _{h,WB} =21,98m/s ² K=1,5m/s ²	
a _h =2,8m/s ² K=1,5m/s ²			a _h =1,39m/s ² K=1,5m/s ²
Шлайф машина със зброя шкурка р80	Трион. водеща шина. смукателна приставка 2x ножа	Трион. с резервни ножове 2бр	Забивач / Такер, 200x пирона, 200x скоби

ТЕХНИЧЕСКА
СПЕЦИФИКАЦИЯ

Наталожен номер на продукт	28075	36328	36329	28060	28076
Име	компресор за въздух	вибратор за плочки	вибратор за плочки	пистолет за уплътняване	радио AKU DAB+ / FM / BT
Манометър	psi; bar; kgf/cm ² ; kPa				
Макс. Налягане	120 psi / 8,2 bar				
Маркуч	∅ 10,5 x 600 mm				
Вендуза		∅ 123 mm	∅ 123 mm		
Товароносимост		60 kg	60 kg		
Вибрация		12 нива на регулиране 3500- 8500 r/min	12 нива на регулиране 3500- 8500 r/min		
Въртящ момент				6500 N	
Регулируема скорост				0- 8,7 mm/s	
Вместимост				310 ml	
Тунер					DAB+ / FM
Външен вход					Bluetooth 5.0, aux IN jack 3,5 mm
Мощност					2 x 15 W
Дисплей					цветен 2,4"
Захранване					адаптер 230 V, батерия Li-ion FESTA share 20 V
Памет					30 (DAB+), 30 (FM)
Устойчивост на проникване на вода					IPX54
Тегло		3 kg	3 kg	1,7 kg	1,3kg
Волтаж	20 V	20 V	20 V	20 V	20 V
Брой в опаковка	компресор, адаптер за захранване от аккумулятора на автомобила, 3x адаптери за надуване	вибратор за плочки, батерия 2,0 Ah, зарядно, случай	вибратор за плочки, случай	Caulking gun	радио, адаптер 230 V



Наталожен номер на продукт	28221	28225	28220	28230	28210	28215
Име	ударна бормашина SDS MAX	ударна бормашина SDS+	ударна бормашина	циркулярен трион	шлайф	шлайф
Мощност	1 500 W	1 500 W	800 W	1 400 W	900 W	2 400 W
Революции	0- 520 min-1	0- 850 min-1	0- 1 350 min-1	0- 4 500 min-1	0- 11 000 min-1	0- 6 600 min-1
ВРМ	0- 4 100	0- 4 500	0- 5 500			
Удар	12 J	6 J	2,8 J			
Глава за инструменти	SDS MAX	SDS+	SDS+ ø 2- 13 mm	20 mm	M14 / 22,2 mm	M14 / 22,2 mm
Регулируем ъгъл на рязане				0- 45°		
Дълбочина на рязане 45°				42 mm		
Дълбочина на рязане 90°				63 mm		
Макс. диаметър на диска				185 mm	125 mm	230 mm
Тегло	3,8 kg	5 kg	3,2 kg	4,3 kg	2 kg	5,8 kg
Захранващ кабел	3 m гума	2 m гума	2 m гума	2 m пластмаса	2 m гума	2 m гума
Брой в опаковка	ударна бормашина, странична дръжка, дълбокомер, гаечен ключ, пластмасова кутия, резервни въгленови четки, аксесоари SDS MAX: ⌀ 16 x 280 mm 18 x 320 mm	ударна бормашина, странична дръжка, дълбокомер, гаечен ключ, пластмасова кутия, резервни въгленови четки, аксесоари SDS+: ⌀ 8, 10, 12 x 160 mm 20 x 250 mm 14 x 250 mm	ударна бормашина, странична дръжка, дълбокомер, патронник ø 2- 13 mm, пластмасова кутия, вазелин, резервни въгленови четки, аксесоари SDS+: ⌀ 6, 8, 10 x 160 mm 20 x 250 mm 14 x 250 mm	циркулярен трион, страничен водач, гаечен ключ, резервни въгленови четки, трион ø 185 x 2,3/1,3 x 20 mm 24T	шлайф, капак на защитния диск, странична дръжка, гаечен ключ, резервни въгленови четки	шлайф, капак на защитния диск, странична дръжка, гаечен ключ, резервни въгленови четки

NEW

Революции
1000 - 1850 min⁻¹

дължина
110 - 180 cm

МОЩНОСТ
750 W

диаметър
на диска
Ø 225 mm



Ергономична, гумирана
дръжка за
безопасен захват



4m

4,0m

1.5m

110 - 180cm

Ø 225 mm

FESTA
POWER X TOOLS

ШЛАЙФ ЗА ГИПСОКАРТОН

230V ~ 50Hz	750W	1000-1850min ⁻¹	Ø 225mm	110-180 cm
LED	4m	DRYWALL		



№ 28240

Характеристики

1

NEW



FESTA
POWER X TOOLS

ПРАХОСМУКАЧКА 30L

230 V ~50 Hz	1600 W	MAX 2000W	82dB	IPX4	3m	5m
30L	WET DRY	AUTO ON-OFF	AUTOMATIC FILTER CLEANING	HEPA A		

№	Характеристики	
28345		1
28346	HEPA филтър	1

NEW



WEST BERG

ПРАХОСМУКАЧКА 30L

230 V ~50 Hz	1200 W	3m	5m	SEMI-AUTOMATIC FILTER CLEANING
30L	WET DRY	AUTO ON-OFF		

№	Характеристики	
28340		1
28342	HEPA филтър	1

FESTA
 POWER X TOOLS

**ЕЛЕКТРИЧЕСКА БЪРКАЛКА
 ЗА СТРОИТЕЛНИ СМЕСИ, 850 W**

Входяща мощност	1800 W
Напрежение	230 V / 50 Hz
Брой скорости	2
1-ва скорост (обороты на празен ход)	0- 450 об. / мин.
2-ва скорост (обороты на празен ход)	0- 790 об. / мин.
Защита	Да
Диаметър на бъркалката	100 mm
Дължина на бъркалката	570 mm
Тегло	5,6 kg



№	Характеристики	Кол-во
35311		1
35318	Резервен накрайник	1
35319	spare stirrers- pair (L + R)	1

FESTA
 POWER X TOOLS

ЕЛЕКТРИЧЕСКА БЪРКАЛКА ЗА СТРОИТЕЛНИ СМЕСИ, 1600 W

Входяща мощност	1600 W
Напрежение	230 V / 50 Hz
Брой скорости	2
1-ва скорост (обороты на празен ход)	0 - 480 об. / мин.
2-ва скорост (обороты на празен ход)	0 - 800 об. / мин.
Защита	Да
Резба	M 14
Диаметър на бъркалката	140 mm
Дължина на бъркалката	600 mm
Тегло	4,7 kg

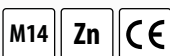

№	Характеристики	Кол-во
35310		1
35317	Резервен накрайник	1

FESTA
 POWER X TOOLS

ЕЛЕКТРИЧЕСКА БЪРКАЛКА ЗА СТРОИТЕЛНИ СМЕСИ, 850 W

Входяща мощност	850 W
Напрежение	230 V / 50 Hz
Брой скорости	1
1-ва скорост (обороты на празен ход)	0 - 500 об. / мин.
2-ва скорост (обороты на празен ход)	-
Защита	Да
Резба	M 14
Диаметър на бъркалката	120 mm
Дължина на бъркалката	600 mm
Тегло	3,7 kg



№	Характеристики	Кол-во
35300		1
35316	Резервен накрайник	1



NEW

WEST BERG

ЕЛЕКТРИЧЕСКА БЪРКАЛКА ЗА СТРОИТЕЛНИ СМЕСИ, 1600 W

Входяща мощност	1600 W
Напрежение	230 V / 50 Hz
Брой скорости	2
1-ва скорост (обороты на празен ход)	180- 400 ot./min.
2-ва скорост (обороты на празен ход)	300- 700 ot./min.
Защита	Да
Резба	M 14
Диаметър на бъркалката	140 mm
Дължина на бъркалката	600 mm
Тегло	5,4 kg



№	Характеристики	
35305		1
35315	Резервен накрайник	1



NEW



FESTA
POWER X TOOLS

МАШИНА ЗА ПОЧИСТВАНЕ ПОД ВИС НАЛЯГАНЕ

230 V ~50 Hz	1800 W	IPX5	MAX 7 l/min	MAX 140 bar	MAX 50°C	5m	AUTO STOP	7,8 kg
-----------------	--------	------	----------------	----------------	-------------	----	-----------	--------

С.р.	Спецификации
45271	



1

FESTA

МАШИНА ЗА ПОЧИСТВАНЕ ПОД ВИС НАЛЯГАНЕ

230 V ~50 Hz	1500 W	MAX 120 bar	MAX 6 l/min	IPX5	5m	AUTO STOP
-----------------	--------	----------------	----------------	------	----	-----------

№	Размери
45270	Машина за почистване



1

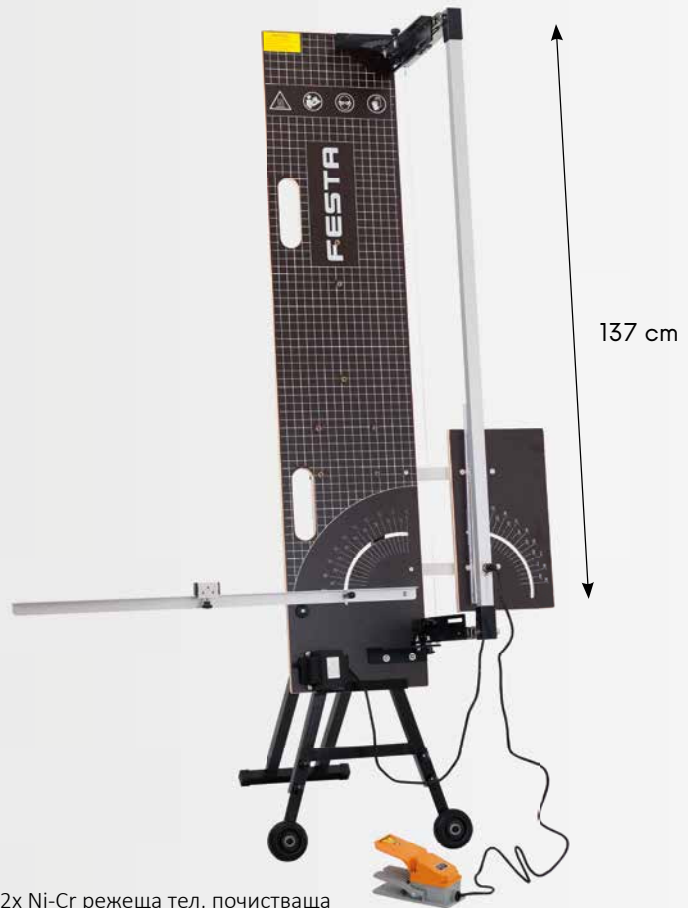
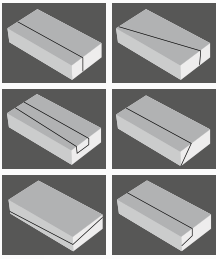

ЕЛЕКТРИЧЕСКИ НОЖ ЗА ПОЛИСТИРЕН

- Напрежение 230 V/50 Hz
- Консумация на енергия 200 W
- Работна дължина 137 cm
- Работна височина 35 cm
- Защита IP44
- Ъгъл на рязане 0° - 90°

· Окомплектовка: стойка, крачен превключвател, държач за скеле, 2x Ni-Cr режеща тел, почистваща месингова четка, инструменти и крепежни елементи, пластмасова кутия с колела



№ 35348 Характеристики

1

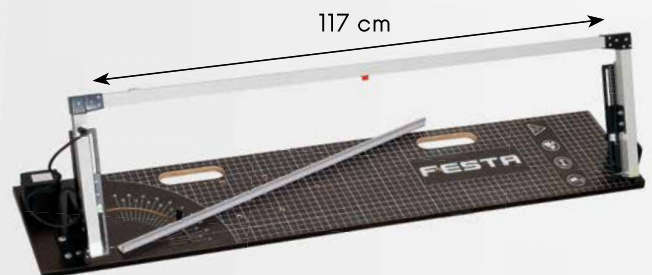
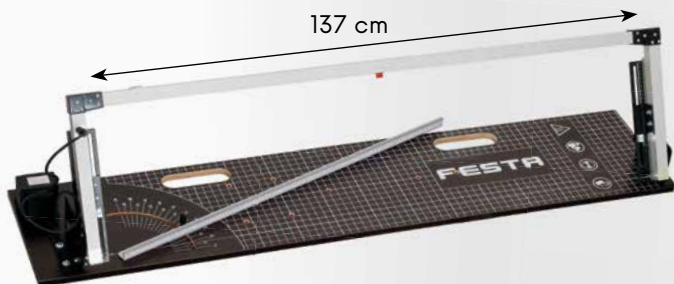
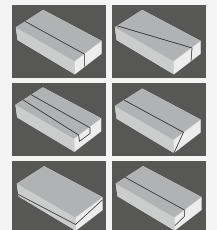
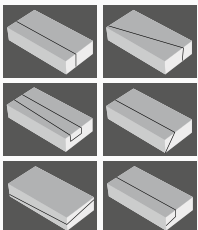

ЕЛЕКТРИЧЕСКИ НОЖ ЗА ПОЛИСТИРЕН

- Напрежение 230 V / 50 Hz
- Консумация на енергия 200 W
- Работна дължина 137 cm
- Работна височина 35 cm
- Защита IP44
- Ъгъл на рязане 0° - 90°



· Окомплектовка: Ni-Cr режеща тел, прибор за почистване, четка



№ 35345

1



ЕЛЕКТРИЧЕСКИ НОЖ ЗА ПОЛИСТИРЕН

- Напрежение 230 V / 50 Hz
- Консумация на енергия 160 W
- Работна дължина 120 cm
- Работна височина 35 cm
- Защита IP44
- Ъгъл на рязане 0° - 90°



· Окомплектовка: Ni-Cr режеща тел, прибор за почистване, четка



№ 35330

1



FESTA

ЕЛЕКТРИЧЕСКИ НОЖ ЗА ПОЛИСТИРЕН

- Напрежение 230 V / 50 Hz
- Консумация на енергия 160 W
- Работна дължина 120 cm
- Работна височина 52 cm
- Защита IP44
- Ъгъл на рязане 0° - 90°



· Окомплектовка: Ni-Cr режеща тел, прибор за почистване, четка

№	Характеристики
35344	



1



FESTA

КРАЧЕН ПЕДАЛ ЗА РЕЗАЧКА ЗА ПОЛИСТИРОЛ

· за 35330, 35345, 35348



№	Характеристики
35334	

1



FESTA

СТОЙКА ЗА РЕЗАЧКА ЗА ПОЛИСТИРОЛ

· за 35330, 35345, 35348



№	Характеристики
35336	

1



FESTA

РЕЗЕРВНА ПРУЖИНА ЗА РЕЗАЧКА ЗА ПОЛИСТИРОЛ

· за 35330, 35345, 35348



№	Характеристики
35332	

1



FESTA

РЕЗЕРВНИ АДАПТЕР ЗА НАПАЈАЊЕ ЗА РЕЗАЧКА ЗА ПОЛИСТИРОЛ

· за 35330, 35345, 35348



Напрежение:	230 V / 50Hz
излаз:	36 V / 5 A
Консумация на енергия:	200 W



№	Характеристики
35347	

1



FESTA

ДЪРЖАЧ ЗА СКЕЛЕ ЗА РЕЗАЧКА ЗА ПОЛИСТИРОЛ

· за 35330, 35345, 35348



№	Характеристики
35333	

1

НИ-ЦР ОТПОРНА ЖИЦА ЗА РЕЗАЧКА ЗА ПОЛИСТИРОЛ



№	Характеристики
35331	за резачка 117 cm
35346	за резачка 137 cm

1

1



Li-ion
technology

FESTA
POWER X TOOLS

АКУМУЛАТОРЕН НОЖ ЗА ПОЛИСТИРОЛ

- батерия **36 V, 1,5Ah Li-ion**
- консумация на енергия **180 W**
- температура **max 350 C°**
- дължина на ножа **20 cm**
- оборудване: 2 батерии, зарядно устройство, острие, месингова четка за почистване, шестостен



№	Характеристики	
35323	Електрически нож за полистирен	1
35328	Резервен нож с дължина 14 cm	1
35329	Резервен нож с дължина 25 cm	1

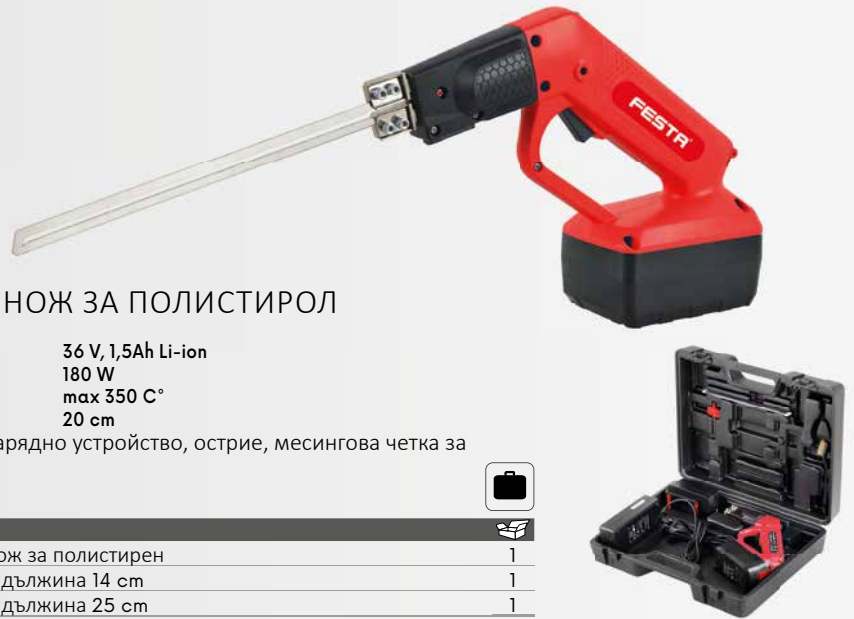

FESTA
POWER X TOOLS

ЕЛЕКТРИЧЕСКИ НОЖ ЗА ПОЛИСТИРЕН

- Напрежение **230 V/50 Hz**
- Консумация на енергия **250 W**
- Температура **50-600 C°**
- Дължина на ножа **25 cm**
- Захранващ кабел **3 m**



· Окомплектовка: режеща тел 25cm + 30cm, прибор за почистване

№	Характеристики	
35326	Електрически нож за полистирен	1
35328	Резервен нож с дължина 14 cm	1
35329	Резервен нож с дължина 25 cm	1



НАПРАВЛЯВАЩА ШИНА ЗА РЯЗАНЕ НА ПОЛИСТИРЕН

№	Характеристики	
35327	Направляваща шина	1
35335	Резервен нож с дължина - 30 cm	1

FESTA
POWER X TOOLS

ЕЛЕКТРИЧЕСКИ НОЖ ЗА ПОЛИСТИРЕН



· С регулация на температурата

№	Характеристики	
35325	220 W	1





FESTA

ИНВЕРТОРЕН ЗАВАРЪЧЕН АПАРАТ ЗА ВИГ И РЕД ЗАВАРЯВАНЕ, 160 А

Захранване/Напрежение	230 V / 50 Hz
Напрежение в покой	55 V
Заваръчен ток	10 - 160 A
Диаметър на електрода	1,5 - 4,0 mm
Продължителност на вкл.	TIG- 160 A / 60%, MMA - 140 A / 60%
Клас защита	IP 21
Заваръчни методи	TIG/MMA
Размери	405 x 165 x 270 mm
Функции	Anti-stick, Arc-force, Hot start, Lift TIG
маса	6 kg



№	Характеристики
70040	Апарат за ВИГ/РЕД заваряване



FESTA

FESTA

ЗАВАРЪЧЕН ШЛЕМ СЪС ЗАТЪМНЕНИЕ, КАРБОНОВ

размер на зрителното поле:	98 x 80 mm
скорост на потъмняване на филтъра	1/25 000 s
затъмняване на филтъра	DIN 5-8 / 9-13
UV / IR защита	DIN 16
оптичен клас	1 1 1 2
брой сензори	4
захранване:	слънчева клетка + батерия CR2450
работен режим	Заваряване, шлайфване



№	Характеристики
70064	активен
70066	резервно покривно стъкло



LCD display





FESTA

ЗАВАРЪЧЕН ШЛЕМ СЪС
ЗАТЪМНЕНИЕ



№	Характеристики	Множ- ство
70063	активен	4



ЗАВАРЪЧЕН ШЛЕМ СЪС
ЗАТЪМНЕНИЕ, КАРБОНОВ



№	Характеристики	Множ- ство
70060	активен	4



ЗАВАРЪЧЕН ШЛЕМ,
КОНТРОЛ НА СТЕПЕНТА
НА ЗАТЪМНЕНИЕ



№	Характеристики	Множ- ство
70061		4



РЕЗЕРВНО ЗАЩИТНО
СТЪКЛО ЗА ЗАВАРЪЧЕН ШЛЕМ

2x

№	Характеристики	Множ- ство
70065	113 x 80 mm	20



ЗАВАРЪЧНИ ОЧИЛА



№	Характеристики	Множ- ство
70062		1

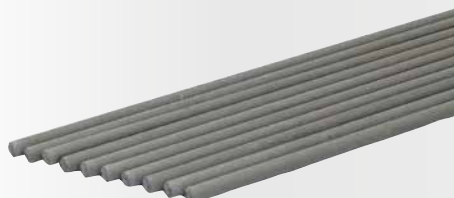

РУТИЛОВИ ЕЛЕКТРОДИ, ER 117

· Сертифицирани

№	Характеристики	мnožství	Множ- ство
70021	Ø 2,0 x 300 mm	10 бр.	1
70020	Ø 2,0 x 300 mm	2,5 kg	8
70026	Ø 2,5 x 300 mm	10 бр.	1
70025	Ø 2,5 x 300 mm	2,5 kg	8
70033	Ø 3,2 x 350 mm	10 бр.	1
70032	Ø 3,2 x 350 mm	5 kg	4



ELEKTRODA BASIC

· Сертифицирани

№	Характеристики	мnožství	Множ- ство
70030	Ø 2,0 x 300 mm	2,5 kg	1
70031	Ø 2,0 x 300 mm	5 kg	1
70035	Ø 2,5 x 300 mm	2,5 kg	8
70036	Ø 2,5 x 300 mm	10 бр.	1
70037	Ø 3,2 x 350 mm	5 kg	5



ЧУК ЗА ЗАВАРКИ



№	Характеристики	Множ- ство
19115	320 g	1



РЪКОХВАТКА
ЗА ЕЛЕКТРОДИ



№	Характеристики	Множ- ство
70070	300 A	1



ЗАВАРЪЧНИ КЛЕЩИ



№	Характеристики	Множ- ство
70075	300 A	1



FESTA

МАГНИТЕН ЪГЪЛ ЗА ЗАВАРЯВАНЕ



№	Характеристики	nosnost	
70096	150 x 130 x 30 mm · 45°, 90°, 135°	25 kg	10

МАГНИТЕН ЪГЪЛ ЗА ЗАВАРЯВАНЕ



№	Характеристики	nosnost	
70090	85 x 85 mm · 45°, 90°	9 kg	10



МАГНИТЕН ЪГЪЛ ЗА ЗАВАРЯВАНЕ



№	Характеристики	nosnost	
70093	95 x 64 mm · 30°, 45°, 60°, 75°, 90°	9 kg	10
70094	120 x 90 mm · 30°, 45°, 60°, 75°, 90°	18 kg	10
70095	137 x 110 mm · 30°, 45°, 60°, 75°, 90°	27 kg	10

МАГНИТЕН ЪГЪЛ ЗА ЗАВАРЯВАНЕ



№	Характеристики	nosnost	
70091	95 x 109 x 25 mm · 45°, 90°, 135°	13 kg	10
70092	130 x 150 x 32 mm · 45°, 90°, 135°	22 kg	5



FESTA
POWER X TOOLS

ПОЯЛНИК ЗА СПОЙКА
НА PVC И PPR ТРЪБИ

- Напрежение 230 V / 50 Hz
- Консумация на енергия 750 / 1500 W
- Температура 0-300 C°
- Удължители Ø 20,25,32,40,50,63 mm
- Тегло 1,6 kg



· Окомплектовка: измервателна лента, нивелир, отвертка, естограм, ножици за тръби



№	
17182	1

FESTA
POWER X TOOLS

ПОЯЛНИК ЗА СПОЙКА
НА PVC И PPR ТРЪБИ

- Напрежение 230 V / 50 Hz
- Консумация на енергия 800 / 1000 W
- Температура 0-300 C°
- Удължители Ø 16, 20, 25, 32 mm
- Тегло 1 kg



· Окомплектовка: куфар, 2 шестограма, винтове, стелаж



№	
17183	1

FESTA

БЕЗМАСЛЕН КОМПРЕСОР, 6-ЛИТРОВ



Напрежение	230 V / 50Hz
Входяща мощност	1,2 kW (1,5HP)
Обем на резервоара	6 l
Макс. налягане	8 Bar
Скорост	3900 min.
Смукателна мощност	180 l/min.
Производителност	116 l/min.
Тегло	10 kg



№	Характеристики	1
35360		



БЕЗМАСЛЕН КОМПРЕСОР, 24-ЛИТРОВ



Входяща мощност	1100 W
Напрежение	230 V / 50Hz
Празен ход	2850 min-1
Работно налягане:	8 bar
Свободно подаване на въздух	160 l / min
Тип	Безмаслен
Обем на резервоара	24 L
Тегло	23 kg



№	Характеристики	1
35361	1,1 kW, 24 l	



КОМПРЕСОР, 24-ЛИТРОВ



Входяща мощност	1500 W
Напрежение	230 V / 50Hz
Празен ход	2850 min-1
Работно налягане:	8 bar
Свободно подаване на въздух	200 l / min
Тип	Маслен
Обем на резервоара	24 L
Тегло	24 kg



№	Характеристики	1
35362	1,5 kW, 24 l	



500 ml

FESTA

БОЯДЖИЙСКИ ПИСТОЛЕТ



Ø 1,5 mm



№	Характеристики	1
48020	Gornji	



600 ml

FESTA

БОЯДЖИЙСКИ ПИСТОЛЕТ



Ø 1,4 mm



№	Характеристики	1
48021	Gornji	
48047	Mlaznica Ø 1,7 mm	



1000 ml

FESTA

БОЯДЖИЙСКИ ПИСТОЛЕТ



Ø 1,4 mm



№	Характеристики	1
48022	Gornji	
48046	Mlaznica Ø 1,5 mm	

FESTA

ПНЕВМАТИЧЕН ПИСТОЛЕТ



№	Характеристики	
48030	dolní	1



ПИСТОЛЕТ ЗА ПРЪСКАНЕ НА БОИ И МАЗИЛКИ

- 4 - 6 Bar
- 5 l
- Дюза Ø 4; 6; 8 mm

№	Характеристики	
48037		1



FESTA

ПНЕВМАТИЧЕН ПИСТОЛЕТ

- 25 mm
- 90 mm
- 190 mm

№	Характеристики	
48004		10



FESTA

ПНЕВМАТИЧЕН ПИСТОЛЕТ

№	Характеристики	
48005	Къс	25



FESTA

ПНЕВМАТИЧЕН ПИСТОЛЕТ

№	Характеристики	
48006	Среден	25



FESTA

ПНЕВМАТИЧЕН ПИСТОЛЕТ

№	Характеристики	
48007	Удължен	25



FESTA

БОЯДЖИЙСКИ ПИСТОЛЕТ

№	Характеристики	
48015	spodní	1



FESTA

ПИСТОЛЕТ ЗА ПОКРИТИЯ



№	Характеристики	
48036	С долен резервоар	1





30 cm

FESTA

ПИСТОЛЕТ С МАНОМЕТЪР

- 0 - 10 bar
- LCD display
- bar, kPa, Psi, kgf/cm²

2x AAA

№	Характеристики	10
48011	0 - 10 bar	10



FESTA

ПИСТОЛЕТ С МАНОМЕТЪР

№	Характеристики	1
48010		1



FESTA

КОМПРЕСОРЕН КОМПЛЕКТ

5x

1. Пистолет за пулверизиране с дънен резервоар
2. Пистолет с манометър
3. Пистолет за пулверизиране с горен резервоар
4. Пневматичен пистолет
5. Маркуч с бързи връзки

№	Характеристики	1
48001		1



FESTA

КОМПРЕСОРЕН КОМПЛЕКТ

3x

1. Пистолет с манометър
2. Пневматичен пистолет
3. Маркуч с бързи връзки

№	Характеристики	1
48002		1

NEW

АДАПТЕРИ ЗА КОМПРЕСОР

8x

№	Характеристики	1
48013		1



FESTA

МАРКУЧ ЗА ПИСТОЛЕТ С КОНЕКТОР

№	Характеристики	1
48043	5 m 8 atm ø 10 mm	1



FESTA

МАРКУЧ ЗА ПИСТОЛЕТ С КОНЕКТОР

№	Характеристики	1
48040	5 m 8 atm ø 8 mm	1
48041	10 m 8 atm ø 8 mm	1
48042	15 m 8 atm ø 8 mm	1



FESTA

МАРКУЧ ЗА ПИСТОЛЕТ С КОНЕКТОР

· max. 20 Bar

№	Характеристики	1
48031	5 m ø 9/15 mm	1
48032	10 m ø 9/15 mm	1
48033	15 m ø 9/15 mm	1
48034	20 m ø 9/15 mm	1

FESTA

ФИЛТЪР

· Макс. налягане 10 bar



№	Характеристики	
48008	G 1/4'	1

FESTA

РЕГУЛАТОР ЗА НАЛЯГАНЕ С МАНОМЕТЪР

· Работно налягане 0 - 10 bar



№	Характеристики	
48009	G 1/4'	1

FESTA

РЕЗЕРВНИ ДЮЗИ

· за 48021



№	Характеристики	
48047	Дюза Ø 1,7 mm	1

FESTA

РЕЗЕРВНИ ДЮЗИ

· за 48022



№	Характеристики	
48046	Дюза Ø 1,5 mm	1

ТАБЛИЦА С РАЗМЕРИ НА РЕЗБИТЕС

РАЗМЕР НА РЕЗБАТА В ИНЧОВЕ	МАКС. ВЪНШЕН Ø В ММ
1/8	9,728
1/4	13,157
3/8	16,662
1/2	20,955
3/4	26,441
1	33,249



КОНЕКТОР ЗА МАРКУЧ С РЕЗБА

№	Характеристики	
48075	1/4' вЪнш.	10
48076	3/8' вЪнш.	10
48077	1/2' вЪнш.	10
48095	1/4' вЪтр	10
48096	3/8' вЪтр	10
48097	1/2' вЪтр	10

ДВОЕН АДАПТЕР С ВЪНШНА РЕЗБА

№	Характеристики	
48050	Конектор 1/4' вЪнш. x 1/4' вЪнш.	10
48051	Редуктор 1/4' вЪнш. x 3/8' вЪнш.	10



АДАПТЕР С РЕЗБА

№	Характеристики	
48085	1/4' - 6 mm	10
48086	3/8' - 9 mm	10
48087	1/2' - 13 mm	10



РЕДУКТОР

№	Характеристики	
48054	3/8' вЪнш. x 1/4' вЪтр	10
48055	1/2' вЪнш. x 3/8' вЪтр	10
48056	Редуктор 3/8' вЪнш. x 1/2' вЪтр	10
48057	Редуктор 1/4' вЪнш. x 3/8' вЪтр	10



АДАПТЕР С РЕЗБА

№	Характеристики	
48080	1/4' вЪнш.	10
48081	3/8' вЪнш.	10
48090	3/8' вЪтр	10
48091	1/4' вЪтр	10

КОНЕКТОР ЗА МАРКУЧ

№	Характеристики	
48070	1/4' - 6 mm	10
48071	3/8' - 9 mm	10
48072	1/2' - 13 mm	10



АДАПТЕР С РЕЗБА

№	Характеристики	
48060	Ø 6 mm - 1/8' вЪнш.	10
48061	Ø 6 mm - 1/4' вЪнш.	10
48062	Ø 6 mm - 3/8' вЪнш.	10
48063	Ø 9 mm - 1/4' вЪнш.	10
48064	Ø 9 mm - 3/8' вЪнш.	10
48065	Ø 13 mm - 1/4' вЪнш.	10
48066	Ø 13 mm - 3/8' вЪнш.	10
48067	Ø 6 mm - 3/8' вЪтр	10
48068	Ø 9 mm - 3/8' вЪтр	10
48093	Ø 6 mm - 1/4' вЪтр	10
48094	Ø 9 mm - 1/4' вЪтр	10

· Дигитален дисплей



ПИСТОЛЕТ ЗА ГОРЕЩ ВЪЗДУХ С КОНТРОЛ НА ТЕМПЕРАТУРАТА

Напрежение	230V / 50Hz
Консумирана мощност	2000W
Позиция на ключа	0 - I (350°C) - II (550°C)
Акcesoари	4 бр. Накрайници от неръждаема стомана- 4 броя



№	Характеристики	1
35320	2000 W	1



ПИСТОЛЕТ ЗА ГОРЕЩ ВЪЗДУХ С КОНТРОЛ НА ТЕМПЕРАТУРАТА И ДЕБИТА

Напрежение	230V / 50 Hz
Консумирана мощност	2000 W
Позиция на ключа	0 - I (50°C) - II (50 - 600°C)
Дебит	120 - 500 l/min.
Акcesoари	4 бр. Накрайници от неръждаема стомана- 4 броя



№	Характеристики	1
35322	2000 W	1

NEW



WEST BERG
ПОЯЛНИК

230V
~ 50Hz **175W**



№	Характеристики	1
28275		1
28278	накрайник за поялник 3 бр.	1



NEW



WEST BERG
ПОЯЛНИК

230V
~ 50Hz **60W**



№	Характеристики	1
28280		1
28282	накрайник за поялник 2 бр.	1



FESTA
POWER X TOOLS

**ПИСТОЛЕТ
ЗА ТОПЛО ЛЕПЕНЕ**

· Ø на пръчките 11,2 mm

230V
~ 50Hz

80W



№ Характеристики

89975



20

NEW



FESTA
POWER X TOOLS

**ПИСТОЛЕТ
ЗА ТОПЛО ЛЕПЕНЕ**

· Ø на пръчките 7,2 mm

230V
~ 50Hz

12W



**ПИСТОЛЕТ
ЗА ТОПЛО ЛЕПЕНЕ**

· Ø на пръчките 7,2 mm

230V
~ 50Hz

15W



**ПИСТОЛЕТ
ЗА ТОПЛО ЛЕПЕНЕ**

· Ø на пръчките 11,2 mm

230V
~ 50Hz

60W



№ Характеристики

89775



1

№ Характеристики

89970



25

№ Характеристики

89973



20



ТОПИЛНИ ПРЪЧКИ, ПРОЗРАЧНИ

№	Ø	Дължина		
89980	7,2 mm	100 mm	12 бр.	100
89988	7,2 mm	100 mm	1 kg	25



ТОПИЛНИ ПРЪЧКИ, ПРОЗРАЧНИ

№	Ø	Дължина		
89985	11,2 mm	200 mm	10 бр.	50
89987	11,2 mm	200 mm	1 kg	25



ТОПИЛНИ ПРЪЧКИ, ЦВЕТНИ

№	Ø	Дължина		
89989	7,2 mm	100 mm	12 бр.	100
89990	11,2 mm	200 mm	10 бр.	50



ПРЕНОСИМ ЕЛЕКТРИЧЕСКИ ОТОПЛИТЕЛ

Напрежение	230V ~50 Hz
Изходяща мощност	3300 W
Работен ток	14.5 A
Производителност	30/1650/3300 W
Температурен обхват	5-40°C
Защита	IP24
Размери	27 x 25.5 x 40 cm
Тегло	4.8 kg



За бързо и ефективно отопление на мазета, работилници, магазини, шатри, оранжерии и др./
Безопасност за работа, възможност за управление на мощността, стаен термостат, вентилатор
Нагревател от неръждаема стомана
Възможност за употреба през летния сезон като вентилатор без затопляне
Отлична работа, качествени материали, солидна конструкция, лесно и сигурно пренасяне, дълъг експлоатационен живот.



№	Характеристики
35833	3,3 kW



1

ГАЗОВ ОТОПЛИТЕЛ

Газ	G30-I3B/P
Налягане	0.7 bar
Напрежение	230 V 50 Hz
Изходяща мощност	25 W
Макс. консумация на газ	1.11 kg/h
Макс. отоплителна мощност	15 kW
Макс. обем на горещ въздух	300 m ³ /h

Възможност за бързо и ефективно отопляване на работилници и строителни обекти
Директно отопление за принудителна циркулация- бързо нагряване
Безопасна употреба и лесно управление на мощността
Термостат и защитен клапан против прегряване и изтичане на газ
Включени в комплекта аксесоари- контролер и маркуч
Отлична работа, качествени материали, солидна конструкция, лесно и сигурно пренасяне, дълъг експлоатационен живот.



№	Характеристики
35845	15 kW



1

ГАЗОВ ОТОПЛИТЕЛ

Газ	g30-i3b/p
Налягане	1.5 bar
Напрежение	230 V 50 Hz
Изходяща мощност	70 W
Макс. консумация на газ	2.2 kg/h
Макс. отоплителна мощност	30 kW
Макс. обем на горещ въздух	750 m ³ /h

Възможност за бързо и ефективно отопляване на работилници и строителни обекти
Директно отопление за принудителна циркулация- бързо нагряване
Безопасна употреба и лесно управление на мощността
Термостат и защитен клапан против прегряване и изтичане на газ
Включени в комплекта аксесоари- контролер и маркуч
Отлична работа, качествени материали, солидна конструкция, лесно и сигурно пренасяне, дълъг експлоатационен живот.



№	Характеристики
35850	30 kW



1



FESTA

LED ЛАМПА



№	Характеристики	
37611		1



FESTA

LED ЛАМПА ЗА СТРОИТЕЛНИ ОБЕКТИ

· Макс. 180 cm

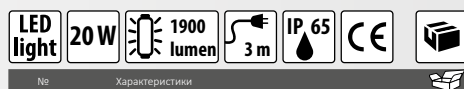

№	Характеристики	
37615	20 W	1
37616	2 x 20 W	1



NEW



FESTA
INDUSTRY

КАБЕЛНА МАКАРА

- rubber - IP44
- H07RN-F3G - 2,5mm²
- Термичен предпазител
- 16 A max. / 3680 W max.
- 4 socket

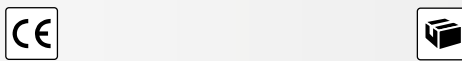

№	Характеристики	
37740	Дължина 25 m, 2,5 mm ²	2
37741	Дължина 50 m, 2,5 mm ²	2

NEW



FESTA
INDUSTRY

КАБЕЛНА МАКАРА

- rubber - IP44
- H05RR-F3G - 1,5mm²
- Термичен предпазител
- 16 A max. / 3680 W max.
- 4 socket

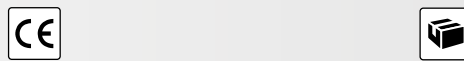

№	Характеристики	
37750	Дължина 25 m, 1,5 mm ²	2
37751	Дължина 50 m, 1,5 mm ²	2

FESTA

КАБЕЛНА МАКАРА

- IP20
- H05VV-F 3G 1,5mm²
- Термичен предпазител
- Мощност в студено състояние : Макс. 1000 W
- Изходяща мощност : Макс. 3000 W
- 4 гнезда



№	Характеристики	
37760	Дължина 25 m, 1,5 mm ²	2
37761	Дължина 50 m, 1,5 mm ²	2

FESTA
INDUSTRY

УДЪЛЖИТЕЛ

- rubber - IP44
- H07RN-F3G - 1,5mm²
- 16 A max. / 3680 W max.



№	Характеристики	
37744	Дължина 5 m, 1,5 mm ²	8
37745	Дължина 10 m, 1,5 mm ²	4
37746	Дължина 20 m, 1,5 mm ²	8
37747	Дължина 30 m, 1,5 mm ²	8

NEW

FESTA

УДЪЛЖИТЕЛ

- IP20
- H05VV-F3G - 1,5mm²
- 16 A max. / 3680 W max.



№	Характеристики	
37730	Дължина 10 m, 1,5 mm ²	8
37731	Дължина 20 m, 1,5 mm ²	4
37732	Дължина 30 m, 1,5 mm ²	8
37733	Дължина 40 m, 1,5 mm ²	4



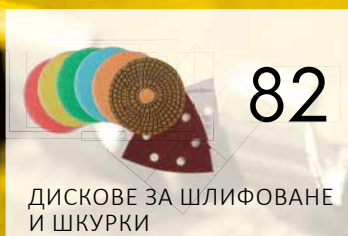
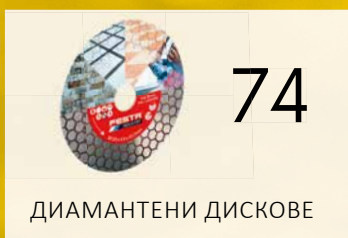

ИНСТРУМЕНТИ ЗА
РЯЗАНЕ, ПРОБИВАНЕ
И ПОЛИРАНЕ

54 - 93



FESTA

СВРЕДЛО ЗА МЕТАЛ, HSS-G, КОБАЛТ

Co 5%, W 6%
Mo 5%, Cr 4%, V 4%

HSS

DIN
338

135°

INOX

1400
MPa

№	Характеристики	№	Характеристики	№	Характеристики
22510	Ø 1,00 mm	22548	Ø 4,80 mm	22590	Ø 9,00 mm
22515	Ø 1,50 mm	22550	Ø 5,00 mm	22595	Ø 9,50 mm
22520	Ø 2,00 mm	22555	Ø 5,50 mm	22600	Ø 10,00 mm
22525	Ø 2,50 mm	22560	Ø 6,00 mm	22602	Ø 10,20 mm
22530	Ø 3,00 mm	22565	Ø 6,50 mm	22605	Ø 10,50 mm
22532	Ø 3,20 mm	22568	Ø 6,80 mm	22610	Ø 11,00 mm
22535	Ø 3,50 mm	22570	Ø 7,00 mm	22615	Ø 11,50 mm
22540	Ø 4,00 mm	22575	Ø 7,50 mm	22620	Ø 12,00 mm
22542	Ø 4,20 mm	22580	Ø 8,00 mm	22625	Ø 12,50 mm
22545	Ø 4,50 mm	22585	Ø 8,50 mm	22630	Ø 13,00 mm

FESTA

СВРЕДЛО ЗА МЕТАЛ, HSS-G W9%, ВОЛФРАМ

W 9%, Mo 3%
Cr 4%, V 1%

HSS

DIN
338

INOX

1100
MPa

№	Характеристики	№	Характеристики	№	Характеристики	№	Характеристики				
19530	Ø 1,00 mm	10	19579	Ø 5,90 mm	5	19612	Ø 9,20 mm	5	19639	Ø 11,90 mm	3
19535	Ø 1,50 mm	10	19580	Ø 6,00 mm	5	19613	Ø 9,30 mm	5	19640	Ø 12,00 mm	3
19536	Ø 1,60 mm	10	19585	Ø 6,50 mm	5	19614	Ø 9,40 mm	5	19641	Ø 12,10 mm	3
19537	Ø 1,70 mm	10	19586	Ø 6,60 mm	5	19615	Ø 9,50 mm	3	19642	Ø 12,20 mm	3
19538	Ø 1,80 mm	10	19587	Ø 6,70 mm	5	19616	Ø 9,60 mm	3	19643	Ø 12,30 mm	3
19539	Ø 1,90 mm	10	19588	Ø 6,80 mm	5	19617	Ø 9,70 mm	3	19644	Ø 12,40 mm	3
19540	Ø 2,00 mm	10	19589	Ø 6,90 mm	5	19618	Ø 9,80 mm	3	19645	Ø 12,50 mm	3
19543	Ø 2,30 mm	10	19590	Ø 7,00 mm	5	19619	Ø 9,90 mm	3	19646	Ø 12,60 mm	1
19544	Ø 2,40 mm	10	19591	Ø 7,10 mm	5	19620	Ø 10,00 mm	3	19647	Ø 12,70 mm	1
19545	Ø 2,50 mm	10	19593	Ø 7,30 mm	5	19621	Ø 10,10 mm	3	19648	Ø 12,80 mm	1
19550	Ø 3,00 mm	10	19594	Ø 7,40 mm	5	19622	Ø 10,20 mm	3	19649	Ø 12,90 mm	1
19552	Ø 3,20 mm	10	19595	Ø 7,50 mm	5	19623	Ø 10,30 mm	3	19650	Ø 13,00 mm	1
19554	Ø 3,40 mm	10	19596	Ø 7,60 mm	5	19624	Ø 10,40 mm	3	19651	Ø 13,20 mm R13	1
19555	Ø 3,50 mm	10	19597	Ø 7,70 mm	5	19625	Ø 10,50 mm	3	19652	Ø 13,50 mm R13	1
19557	Ø 3,70 mm	10	19598	Ø 7,80 mm	5	19626	Ø 10,60 mm	3	19653	Ø 14,00 mm R13	1
19559	Ø 3,90 mm	10	19599	Ø 7,90 mm	5	19627	Ø 10,70 mm	3	19654	Ø 14,50 mm R13	1
19560	Ø 4,00 mm	10	19600	Ø 8,00 mm	5	19628	Ø 10,80 mm	3	19655	Ø 15,00 mm R13	1
19562	Ø 4,20 mm	10	19601	Ø 8,10 mm	5	19629	Ø 10,90 mm	3	19656	Ø 15,50 mm R13	1
19564	Ø 4,40 mm	10	19603	Ø 8,30 mm	5	19630	Ø 11,00 mm	3	19657	Ø 16,00 mm R13	1
19565	Ø 4,50 mm	10	19604	Ø 8,40 mm	5	19631	Ø 11,10 mm	3	19658	Ø 16,50 mm R13	1
19567	Ø 4,70 mm	10	19605	Ø 8,50 mm	5	19632	Ø 11,20 mm	3	19659	Ø 17,00 mm R13	1
19568	Ø 4,80 mm	10	19606	Ø 8,60 mm	5	19633	Ø 11,30 mm	3	19660	Ø 17,50 mm R13	1
19570	Ø 5,00 mm	5	19607	Ø 8,70 mm	5	19634	Ø 11,40 mm	3	19661	Ø 18,00 mm R13	1
19574	Ø 5,40 mm	5	19608	Ø 8,80 mm	5	19635	Ø 11,50 mm	3	19662	Ø 18,50 mm R13	1
19575	Ø 5,50 mm	5	19609	Ø 8,90 mm	5	19636	Ø 11,60 mm	3	19663	Ø 19,00 mm R13	1
19576	Ø 5,60 mm	5	19610	Ø 9,00 mm	5	19637	Ø 11,70 mm	3	19664	Ø 19,50 mm R13	1
19577	Ø 5,70 mm	5	19611	Ø 9,10 mm	5	19638	Ø 11,80 mm	3	19665	Ø 20,00 mm R13	1
19578	Ø 5,80 mm	5									

FESTAКУТИЯ СВРЕДЛА ЗА МЕТАЛ,
HSS-G W9%, ВОЛФРАМW 9%, Mo 3%
Cr 4%, V 1%

HSS

DIN
338

INOX

1100
MPa

№	Характеристики	№	Характеристики
19669		1	
90191	без свредла	1	

№	съдържанието на комплекта	№	съдържанието на комплекта
19530	Ø 1,00 mm 20x	19585	Ø 6,50 mm 15x
19535	Ø 1,50 mm 20x	19590	Ø 7,00 mm 15x
19540	Ø 2,00 mm 20x	19595	Ø 7,50 mm 15x
19545	Ø 2,50 mm 20x	19600	Ø 8,00 mm 15x
19550	Ø 3,00 mm 20x	19605	Ø 8,50 mm 15x
19552	Ø 3,20 mm 20x	19610	Ø 9,00 mm 15x
19555	Ø 3,50 mm 20x	19615	Ø 9,50 mm 15x
19558	Ø 3,80 mm 20x	19620	Ø 10,00 mm 15x
19560	Ø 4,00 mm 30x	19625	Ø 10,50 mm 6x
19562	Ø 4,20 mm 20x	19630	Ø 11,00 mm 6x
19565	Ø 4,50 mm 20x	19635	Ø 11,50 mm 6x
19568	Ø 4,80 mm 20x	19640	Ø 12,00 mm 6x
19570	Ø 5,00 mm 15x	19645	Ø 12,50 mm 6x
19575	Ø 5,50 mm 15x	19650	Ø 13,00 mm 6x
19580	Ø 6,00 mm 30x		

FESTA

СВРЕДЛО ЗА МЕТАЛ

W 4%, Mo 3%
Cr 4%, V 1%

HSS

DIN
338

ALU 900 MPa



MOQ

№	Характеристики	№	Характеристики	№	Характеристики	№	Характеристики				
19670	Ø 0,6 mm	10	19703	Ø 4,0 mm	10	19736	Ø 7,3 mm	10	19769	Ø 10,6 mm	5
19671	Ø 0,8 mm	10	19704	Ø 4,1 mm	10	19737	Ø 7,4 mm	10	19770	Ø 10,7 mm	5
19672	Ø 0,9 mm	10	19705	Ø 4,2 mm	10	19738	Ø 7,5 mm	10	19771	Ø 10,8 mm	5
19673	Ø 1,0 mm	10	19706	Ø 4,3 mm	10	19739	Ø 7,6 mm	10	19772	Ø 11,0 mm	5
19674	Ø 1,1 mm	10	19707	Ø 4,4 mm	10	19740	Ø 7,7 mm	10	19773	Ø 11,2 mm	5
19675	Ø 1,2 mm	10	19708	Ø 4,5 mm	10	19741	Ø 7,8 mm	10	19774	Ø 11,3 mm	5
19676	Ø 1,3 mm	10	19709	Ø 4,6 mm	10	19742	Ø 7,9 mm	10	19775	Ø 11,4 mm	5
19677	Ø 1,4 mm	10	19710	Ø 4,7 mm	10	19743	Ø 8,0 mm	10	19776	Ø 11,5 mm	5
19678	Ø 1,5 mm	10	19711	Ø 4,8 mm	10	19744	Ø 8,1 mm	10	19777	Ø 11,6 mm	5
19679	Ø 1,6 mm	10	19712	Ø 4,9 mm	10	19745	Ø 8,2 mm	10	19778	Ø 11,7 mm	5
19680	Ø 1,7 mm	10	19713	Ø 5,0 mm	10	19746	Ø 8,3 mm	10	19779	Ø 11,8 mm	5
19681	Ø 1,8 mm	10	19714	Ø 5,1 mm	10	19747	Ø 8,4 mm	10	19780	Ø 11,9 mm	5
19682	Ø 1,9 mm	10	19715	Ø 5,2 mm	10	19748	Ø 8,5 mm	10	19781	Ø 12,0 mm	5
19683	Ø 2,0 mm	10	19716	Ø 5,3 mm	10	19749	Ø 8,6 mm	5	19782	Ø 12,2 mm	5
19684	Ø 2,1 mm	10	19717	Ø 5,4 mm	10	19750	Ø 8,7 mm	5	19783	Ø 12,5 mm	5
19685	Ø 2,2 mm	10	19718	Ø 5,5 mm	10	19751	Ø 8,8 mm	5	19784	Ø 12,8 mm	5
19686	Ø 2,3 mm	10	19719	Ø 5,6 mm	10	19752	Ø 8,9 mm	5	19785	Ø 12,9 mm	5
19687	Ø 2,4 mm	10	19720	Ø 5,7 mm	10	19753	Ø 9,0 mm	5	19786	Ø 13,0 mm	5
19688	Ø 2,5 mm	10	19721	Ø 5,8 mm	10	19754	Ø 9,1 mm	5	19787	Ø 13,2 mm R13	5
19689	Ø 2,6 mm	10	19722	Ø 5,9 mm	10	19755	Ø 9,2 mm	5	19788	Ø 13,5 mm R13	5
19690	Ø 2,7 mm	10	19723	Ø 6,0 mm	10	19756	Ø 9,3 mm	5	19789	Ø 14,0 mm R13	5
19691	Ø 2,8 mm	10	19724	Ø 6,1 mm	10	19757	Ø 9,4 mm	5	19790	Ø 14,5 mm R13	5
19692	Ø 2,9 mm	10	19725	Ø 6,2 mm	10	19758	Ø 9,5 mm	5	19791	Ø 15,0 mm R13	5
19693	Ø 3,0 mm	10	19726	Ø 6,3 mm	10	19759	Ø 9,6 mm	5	19792	Ø 15,5 mm R13	5
19694	Ø 3,1 mm	10	19727	Ø 6,4 mm	10	19760	Ø 9,7 mm	5	19793	Ø 16,0 mm R13	5
19695	Ø 3,2 mm	10	19728	Ø 6,5 mm	10	19761	Ø 9,8 mm	5	19794	Ø 16,5 mm R13	5
19696	Ø 3,3 mm	10	19729	Ø 6,6 mm	10	19762	Ø 9,9 mm	5	19795	Ø 17,0 mm R13	5
19697	Ø 3,4 mm	10	19730	Ø 6,7 mm	10	19763	Ø 10,0 mm	5	19796	Ø 17,5 mm R13	5
19698	Ø 3,5 mm	10	19731	Ø 6,8 mm	10	19764	Ø 10,1 mm	5	19797	Ø 18,0 mm R13	5
19699	Ø 3,6 mm	10	19732	Ø 6,9 mm	10	19765	Ø 10,2 mm	5	19798	Ø 18,5 mm R13	5
19700	Ø 3,7 mm	10	19733	Ø 7,0 mm	10	19766	Ø 10,3 mm	5	19799	Ø 19,0 mm R13	5
19701	Ø 3,8 mm	10	19734	Ø 7,1 mm	10	19767	Ø 10,4 mm	5	19800	Ø 19,5 mm R13	5
19702	Ø 3,9 mm	10	19735	Ø 7,2 mm	10	19768	Ø 10,5 mm	5	19801	Ø 20,0 mm R13	5

FESTA

КУТИЯ СВРЕДЛА ЗА МЕТАЛ, HSS 4341

W 4%, Mo 3%
Cr 4%, V 1%

HSS

DIN
338

ALU 900 MPa



№	съдържанието на комплекта	№	съдържанието на комплекта
19673	Ø 1,00 mm 20x	19728	Ø 6,50 mm 20x
19678	Ø 1,50 mm 20x	19733	Ø 7,00 mm 10x
19683	Ø 2,00 mm 20x	19738	Ø 7,50 mm 10x
19688	Ø 2,50 mm 20x	19743	Ø 8,00 mm 10x
19693	Ø 3,00 mm 30x	19748	Ø 8,50 mm 10x
19695	Ø 3,20 mm 30x	19753	Ø 9,00 mm 10x
19698	Ø 3,50 mm 30x	19758	Ø 9,50 mm 10x
19701	Ø 3,80 mm 30x	19763	Ø 10,00 mm 10x
19703	Ø 4,00 mm 30x	19768	Ø 10,50 mm 10x
19705	Ø 4,20 mm 30x	19772	Ø 11,00 mm 10x
19708	Ø 4,50 mm 30x	19776	Ø 11,50 mm 10x
19711	Ø 4,80 mm 30x	19781	Ø 12,00 mm 10x
19713	Ø 5,00 mm 20x	19783	Ø 12,50 mm 10x
19718	Ø 5,50 mm 20x	19786	Ø 13,00 mm 5x
19723	Ø 6,00 mm 20x		

FESTA

УДЪЛЖЕНО СВРЕДЛО ЗА МЕТАЛ, HSS

W 4%, Mo 3%
Cr 4%, V 1%

HSS

DIN
340

ALU



MOQ

№	Характеристики	№	Характеристики	№	Характеристики			
20220	Ø 2,0 mm x 85 mm	1	20245	Ø 4,5 mm x 126 mm	1	20280	Ø 8,0 mm x 165 mm	1
20225	Ø 2,5 mm x 95 mm	1	20250	Ø 5,0 mm x 132 mm	1	20290	Ø 9,0 mm x 175 mm	1
20230	Ø 3,0 mm x 100 mm	1	20255	Ø 5,5 mm x 139 mm	1	20296	Ø 10,0 mm x 184 mm	1
20235	Ø 3,5 mm x 110 mm	1	20260	Ø 6,0 mm x 139 mm	1			
20240	Ø 4,0 mm x 119 mm	1	20270	Ø 7,0 mm x 156 mm	1			

СВРЕДЛО ЗА МЕТАЛ, HSS-TiN, ТИТАНИЙ, ЕДИНИЧНА ОПАКОВКА

• Титаниева повърхност за по-добра ефективност и устойчивост

TiN HSS DIN 338



№	Характеристики	Упаковка
20400	Ø 1,0 mm	1
20401	Ø 1,5 mm	1
20402	Ø 2,0 mm	1
20403	Ø 2,5 mm	1
20404	Ø 3,0 mm	1
20405	Ø 3,2 mm	1
20406	Ø 3,5 mm	1
20407	Ø 3,8 mm	1
20408	Ø 4,0 mm	1
20409	Ø 4,2 mm	1
20410	Ø 4,5 mm	1

№	Характеристики	Упаковка
20411	Ø 4,8 mm	1
20412	Ø 5,0 mm	1
20413	Ø 5,5 mm	1
20414	Ø 6,0 mm	1
20415	Ø 6,5 mm	1
20416	Ø 6,8 mm	1
20417	Ø 7,0 mm	1
20418	Ø 7,5 mm	1
20419	Ø 8,0 mm	1
20420	Ø 8,5 mm	1
20421	Ø 9,0 mm	1

№	Характеристики	Упаковка
20422	Ø 9,5 mm	1
20423	Ø 10,0 mm	1
20424	Ø 10,2 mm	1
20425	Ø 10,5 mm	1
20426	Ø 11,0 mm	1
20427	Ø 11,5 mm	1
20428	Ø 12,0 mm	1
20429	Ø 12,5 mm	1
20430	Ø 13,0 mm	1

СВРЕДЛО ЗА МЕТАЛ, HSS

HSS DIN 338

ALU



№	Характеристики	Упаковка
19841	Ø 4,1 mm 5 ks	10
19842	Ø 4,2 mm 5 ks	10
19845	Ø 4,5 mm 5 ks	10
19885	Ø 8,5 mm 1 ks	10
19895	Ø 9,5 mm 1 ks	10



FESTA

КОМПЛЕКТ СВРЕДЛА ЗА МЕТАЛ, HSS

W 9%, Mo 3% Cr 4%, V 1% HSS DIN 338

13x



№	Характеристики	Упаковка
20333	Ø 1,5 - 6,5 mm	20



FESTA

КОМПЛЕКТ СВРЕДЛА ЗА МЕТАЛ, HSS

W 9%, Mo 3% Cr 4%, V 1% HSS DIN 338

19x



№	Характеристики	Упаковка
20334	Ø 1,0 - 10,0 mm	20



FESTA

КОМПЛЕКТ СВРЕДЛА ЗА МЕТАЛ, HSS

W 9%, Mo 3% Cr 4%, V 1% HSS DIN 338

25x



№	Характеристики	Упаковка
20335	Ø 1,0 - 13,0 mm	5



FESTA

КОМПЛЕКТ СВРЕДЛА ЗА МЕТАЛ

W 4%, Mo 3% Cr 4%, V 1% HSS DIN 338

13x



№	Характеристики	Упаковка
20336	Ø 1,5 - 6,5 mm	1



FESTA

КОМПЛЕКТ СВРЕДЛА ЗА МЕТАЛ

W 4%, Mo 3% Cr 4%, V 1% HSS DIN 338

19x



№	Характеристики	Упаковка
20337	Ø 1,0 - 10,0 mm	20



FESTA

КОМПЛЕКТ СВРЕДЛА ЗА МЕТАЛ

W 4%, Mo 3% Cr 4%, V 1% HSS DIN 338

25x



№	Характеристики	Упаковка
20338	Ø 1,0 - 13,0 mm	10

FESTA

КОМПЛЕКТ СВРЕДЛА

TiN



9x



№	Характеристики	Иконка
20317	Ø 5-6-8 mm	20

FESTA

КОМПЛЕКТ СВРЕДЛА С ШЕСТОСТЕННА ОПАШКА

1/4" HSS



7x



№	Характеристики	Иконка
20316	Ø 1,5-2-3-4-5-5,5-6 mm	20



КОМПЛЕКТ СВРЕДЛА ЗА МЕТАЛ

HSS DIN 338



19x



№	Характеристики	Иконка
20305	Ø 1,0 - 13,0 mm	25

КОМПЛЕКТ СВРЕДЛА ЗА МЕТАЛ

HSS DIN 338



25x



№	Характеристики	Иконка
20311	Ø 1,0 - 13,0 mm	10

КОМПЛЕКТ СВРЕДЛА ЗА МЕТАЛ

HSS DIN 338



13x



№	Характеристики	Иконка
20300	Ø 1,5 - 6,5 mm	50

КОМПЛЕКТ СВРЕДЛА ЗА МЕТАЛ

HSS DIN 338



19x



№	Характеристики	Иконка
20310	Ø 1 - 13 mm	10

КОМПЛЕКТ СВРЕДЛА

- свредло за дърво \varnothing 3 · 4 · 5 · 6 · 8 mm
- свредло за метал \varnothing 1 · 1,5 · 2 · 2,5 · 3 · 3,5 · 4 · 4,5 · 5 · 5,5 · 6 · 7 · 8 · 10 mm
- свредло за зидария \varnothing 4 · 5 · 6 · 8 · 10 mm
- плоско свредло за дърво \varnothing 16 · 22 · 25 mm
- трион за дупки \varnothing 32 · 38 · 44 · 54 mm
- ограничители за дълбочина \varnothing 6 · 8 · 10 mm
- централен удар
- уред за измерване на диаметра на свредлото

- бит 25 mm
- ⊖ S 3 · 4 · 4 · 5 · 5 · 6 · 6 · 7
 - ⊕ PH 0 · 0 · 1 · 1 · 2 · 2 · 2 · 3 · 3
 - ⊗ PZ 0 · 0 · 1 · 1 · 2 · 2 · 2 · 3 · 3
 - H 2 · 2,5 · 3 · 3,5 · 4 · 5 · 6
 - ⊗ T 10 · 15 · 20 · 25 · 27 · 30 · 40

- бит 50 mm
- ⊖ S 4 · 5 · 6 · 6
 - ⊕ PH 1 · 2 · 2 · 3
 - ⊗ PZ 1 · 2 · 2 · 3

- адаптер \varnothing 4 · 5 · 6 · 7 · 8 · 9 · 10 · 13 mm
- Уред за премахване на граповина
държач за битове

100x

№	Характеристики	1
20340		1



КОМПЛЕКТ СВРЕДЛА ЗА МЕТАЛ

HSS DIN 338



19x

№	Характеристики	10
20315	\varnothing 1 - 10 mm	10

КОМПЛЕКТ СВРЕДЛА ЗА МЕТАЛ

TiN HSS DIN 338



19x

№	Характеристики	30
20320	\varnothing 1 - 10 x 0,5 mm	30



КОМПЛЕКТ СВРЕДЛА ЗА МЕТАЛ

HSS DIN 338



19x

№	Характеристики	5
20321	\varnothing 1 - 10 x 0,5 mm	5



ТОЧИЛО ЗА СВРЕДЛА

№	Характеристики	20
20380	за \varnothing 3,5 - 10 mm	20

FESTA

БОРКОРОНИ, БИ МЕТАЛ



№	Характеристики	1
24419	\varnothing 19 mm	1
24420	\varnothing 20 mm	1
24422	\varnothing 22 mm	1
24425	\varnothing 25 mm	1
24429	\varnothing 29 mm	1
24432	\varnothing 32 mm	1
24435	\varnothing 35 mm	1
24437	\varnothing 37 mm	1
24444	\varnothing 44 mm	1
24451	\varnothing 51 mm	1
24457	\varnothing 57 mm	1
24464	\varnothing 64 mm	1
24468	NEW \varnothing 68 mm	1
24476	\varnothing 76 mm	1
24483	\varnothing 83 mm	1



FESTA

НОСАЧ ЗА БОРКОРОНИ

№	Характеристики	1
24410	за БОРКОРОНИ 14 - 30 mm	1



FESTA

НОСАЧ ЗА БОРКОРОНИ

№	Характеристики	1
24411	за БОРКОРОНИ 32 - 152 mm	1



FESTA

НОСАЧ ЗА БОРКОРОНИ

№	Характеристики	5
24412	for 24410, 24411	5



FESTA

КОМПЛЕКТ
БОРКОРОНИ,
БИ МЕТАЛ

HSS



9x



№	Характеристики	10
24750	Ø 19, 22, 29, 38, 44, 57 mm	10

FESTA

КОМПЛЕКТ
БОРКОРОНИ,
БИ МЕТАЛ

HSS



13x



№	Характеристики	10
24751	Ø 19, 22, 29, 35, 38, 44, 51, 57, 64 mm	10



FESTA

СТЪПАЛОВИДНО СВРЕДЛО,
ТИТАН

TiN

HSS



№	Характеристики	20
20489	Ø 4 - 12 mm 9 стъпала	20
20490	Ø 4 - 20 mm 9 стъпала	10
20491	Ø 5 - 35 mm 13 стъпала	10
20492	Ø 7 - 40,5 mm 13 стъпала	5

FESTA

КОМПЛЕКТ СТЪПАЛОВИДНИ
СВРЕДЛА, ТИТАН

TiN

HSS



3x



№	Характеристики	1
20495	Ø 4 - 12, 4 - 20, 4 - 32 mm	1

СТЪПАЛОВИДНО СВРЕДЛО,
HSS

HSS



№	Характеристики	10
20487	Ø 4 - 20 mm 9 стъпала	10
20488	Ø 5 - 35 mm 13 стъпала	10
20494	Ø 4 - 32 mm 15 стъпала	10
20493	Ø 7 - 40,5 mm 13 стъпала	1

КОМПЛЕКТ СТЪПАЛОВИДНИ
СВРЕДЛА

HSS



3x



№	Характеристики	1
20496	Ø 4 - 12, 4 - 20, 4 - 32 mm	1



FESTA

ЕКСТРАКТОРИ

- ∅ 4 mm ∅ 11 mm
- ∅ 4,5 mm ∅ 15 mm
- ∅ 6,5 mm ∅ 19 mm
- ∅ 7,5 mm ∅ 24 mm

8x

№	Характеристики	
20387		5



ВЪРТОК ЗА МЕТЧИЦИ

№	Характеристики	
20397	M3 - M8	10



FESTA

ЕКСТРАКТОРИ

- ∅ 4 mm
- ∅ 4,5 mm
- ∅ 6 mm
- ∅ 7,5 mm
- ∅ 11 mm

5x

№	Характеристики	
20386		10



ЕКСТРАКТОРИ

- ∅ 4 mm
- ∅ 4,5 mm
- ∅ 6 mm
- ∅ 7,5 mm
- ∅ 11 mm

5x

№	Характеристики	
20385		10



FESTA

ВЪРТОК ЗА ПЛАШКИ

DIN 225

№	Характеристики	
20396	25 x 9 mm	10



FESTA

ВЪРТОК ЗА МЕТЧИЦИ

DIN 1814

№	Характеристики	
20394	M5 - M20	10
20395	1 - 1/2', M3 - M12	10



FESTA

КОМПЛЕКТ ПЛАШКИ И МЕТЧИЦИ С ВЪРТОЦИ

32x

№	Характеристики	
20391	M 3, 4, 5, 6, 8, 10, 12 mm	1



FESTA

КОМПЛЕКТ МЕТЧИЦИ

21x

№	Характеристики	
20390	M 3, 4, 5, 6, 8, 10, 12 mm	1

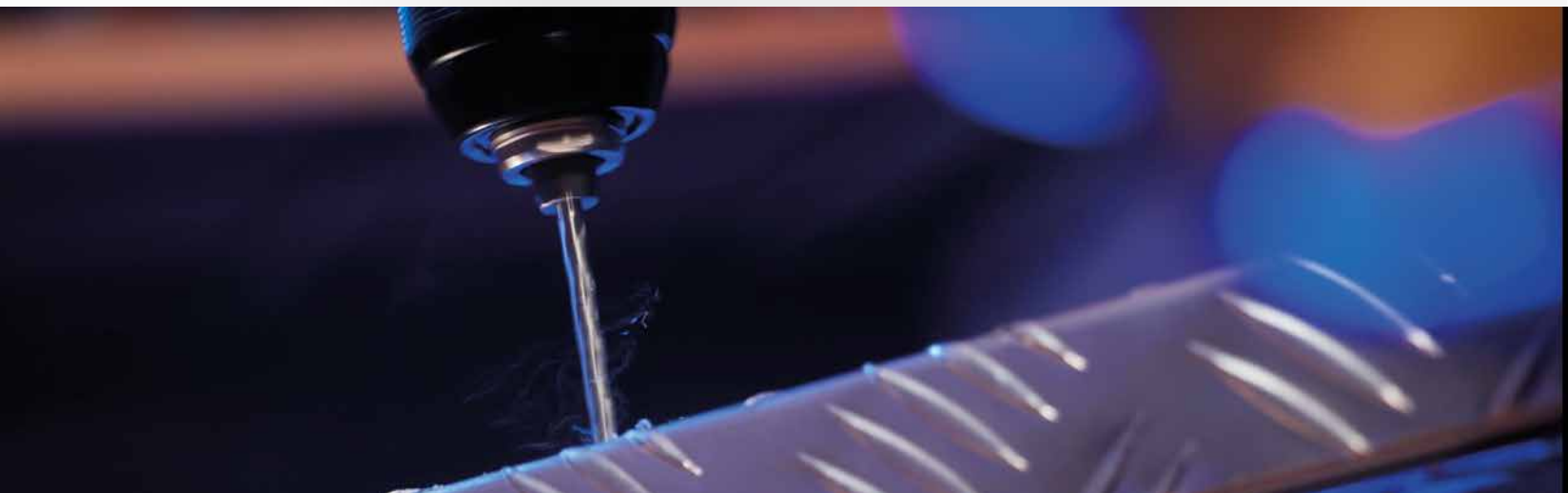

NEW

FESTA

СВРЕДЛО FORSTNER

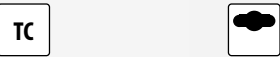

№	Характеристики	
21531	Ø 15 mm	1
21532	Ø 20 mm	1
21533	Ø 25 mm	1
21534	Ø 30 mm	1
21535	Ø 35 mm	1
21536	Ø 40 mm	1



FESTA



FESTA

СВРЕДЛО ЗА ДЪРВО



№	Характеристики	
20980	Ø 6 x 230 mm	1
20957	Ø 6 x 300 mm	1
20981	Ø 8 x 230 mm	1
20958	Ø 8 x 300 mm	1
20982	Ø 10 x 230 mm	1
20896	Ø 10 x 300 mm	1
20913	Ø 10 x 450 mm	1
20983	Ø 12 x 230 mm	1
20897	Ø 12 x 300 mm	1
20915	Ø 12 x 450 mm	1
20920	Ø 12 x 600 mm	1
20898	Ø 14 x 300 mm	1
20916	Ø 14 x 450 mm	1
20921	Ø 14 x 600 mm	1

№	Характеристики	
20984	Ø 16 x 230 mm	1
20899	Ø 16 x 300 mm	1
20917	Ø 16 x 450 mm	1
20922	Ø 16 x 600 mm	1
20918	Ø 18 x 450 mm	1
20923	Ø 18 x 600 mm	1
20919	Ø 20 x 450 mm	1
20924	Ø 20 x 600 mm	1
20724	Ø 22 x 450 mm	1
20725	Ø 24 x 450 mm	1
20726	Ø 26 x 450 mm	1
20727	Ø 28 x 450 mm	1
20728	Ø 30 x 450 mm	1

FESTA

КОМПЛЕКТ СВРЕДЛА ЗА ДЪРВО



5x

№	Характеристики	
20911	Ø 8, 10, 12, 14, 16 x 460 mm	10



FESTA

КОМПЛЕКТ СВРЕДЛА ЗА ДЪРВО



6x

№	Характеристики	
20912	Ø 6, 8, 10, 12, 16, 20 x 230 mm	10



СВРЕДЛО ЗА ДЪРВО, УДЪЛЖЕНО



№	Характеристики	
20729	Ø 6 x 400 mm	1
20731	Ø 8 x 400 mm	1
20736	Ø 8 x 600 mm	1
20730	Ø 10 x 400 mm	1
20737	Ø 10 x 600 mm	1

№	Характеристики	
20732	Ø 12 x 400 mm	1
20738	Ø 12 x 600 mm	1
20733	Ø 14 x 400 mm	1
20739	Ø 14 x 600 mm	1

№	Характеристики	
20734	Ø 16 x 400 mm	1
20740	Ø 16 x 600 mm	1
20735	Ø 18 x 400 mm	1
20741	Ø 18 x 600 mm	1

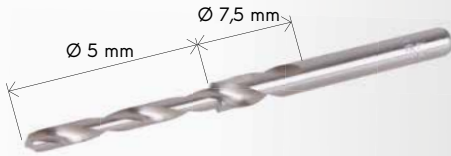

FESTA

ДВУСТЕПЕННИ СВРЕДЛО



№	Характеристики	Куб
20210	Ø 7.5, 5 mm	1



СВРЕДЛО ЗА ДЪРВО

№	Характеристики	Куб
21440	Ø 4 x 75 mm	1
21441	Ø 5 x 85 mm	1
21442	Ø 6 x 90 mm	1
21443	Ø 7 x 105 mm	1
21444	Ø 8 x 115 mm	1
21445	Ø 9 x 120 mm	1
21446	Ø 10 x 120 mm	1



БОРФРЕЗА ЗА ДЪРВО



№	Характеристики	Куб
20460	Ø 6 mm	50



КОМПЛЕКТ СВРЕДЛА ЗА ДЪРВО



№	Характеристики	Куб
20910	8 бр. Ø 3, 4, 5, 6, 7, 8, 9, 10 mm	10
20905	5 бр. Ø 4, 5, 6, 8, 10 mm	10



КОМПЛЕКТ БОРФРЕЗИ ЗА ДЪРВО



№	Характеристики	Куб
21530	Ø 15, 20, 25, 30, 35 mm Ø 8 mm	20



КОМПЛЕКТ БОРФРЕЗИ ЗА ДЪРВО



№	Характеристики	Куб
20450	Ø 3, 4, 5, 6, 6.5, 8 mm	20

КОМПЛЕКТ СВРЕДЛА ЗА ДЪРВО, ПЛОСКИ



№	Характеристики	Куб
20901	Ø 10, 12, 16, 18, 20, 25 mm	20



РЪЧНО ДЪРВОДЕЛСКО СВРЕДЛО, КОМПЛЕКТ

HOBBY

4x

№	Характеристики	Куб
20381	Ø 2, 3, 4, 5 mm	20





FESTA

БОРКОРОНА ЗА ДЪРВО, КОМПЛЕКТ

- Ø 19 mm
- Ø 22 mm
- Ø 25,5 mm
- Ø 36 mm
- Ø 44 mm
- Ø 51 mm
- Ø 60 mm
- Ø 67 mm
- Ø 76 mm
- Ø 82 mm

Шестограм
2x център



12x



№	Характеристики	
24712	6 tpi	20



FESTA

БОРКОРОНА ЗА ДЪРВО, КОМПЛЕКТ

- Ø 64 mm
- Ø 73 mm
- Ø 89 mm
- Ø 102 mm
- Ø 127 mm

Шестограм
Център



8x



№	Характеристики	
24706	6 tpi	20



FESTA

БОРКОРОНА ЗА ФАЯНС РЕГУЛИРУЕМА

· Ø 19 - 127 mm

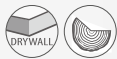

№	Характеристики	
24415	Ø 19 - 127 mm	максимална дълбочина 29 mm 6

FESTA

БОРКОРОНА ЗА ДЪРВО



№	Характеристики	
24715	1' Ø 67 mm	6 tpi 5
24713	1' Ø 73 mm	6 tpi 5
24714	1' Ø 102 mm	6 tpi 5
24720	1' Ø 152 mm	6 tpi 5



БОРКОРОНА ЗА ДЪРВО, КОМПЛЕКТ



№	Характеристики	
24721	1' Ø 26, 32, 38, 45, 50, 56, 63 mm	10
24722	2' Ø 26, 32, 38, 45, 50, 56, 63 mm	10

РЕГУЛИРУЕМ РЕЗЕЦ ЗА КЪРГЛИ ОТВОРИ



№	Характеристики	
24716	Ø 30 - 120 mm	5



FESTA

БОРФРЕЗИ

M14



№	Характеристики	
21807	Ø 30 mm / 60 mm	1

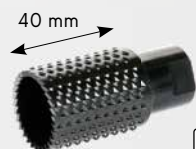

FESTA

БОРФРЕЗИ

M14



№	Характеристики	
21808	Ø 30 mm / 105 mm	10





КОМПЛЕКТ
БОРФРЕЗИ

5x



№ 21541
Характеристики

25



КОМПЛЕКТ ШЛАЙФГРИФЕРИ

5x



№ 21540
Характеристики
Ø 3 mm, 6 mm

12

КОМПЛЕКТ
АКСЕСОАРИ
ЗА ШЛИФОВАНЕ

190x



№ 24755
Характеристики

5

КОМПЛЕКТ
АКСЕСОАРИ
ЗА ШЛИФОВАНЕ

150x



№ 24756
Характеристики

10



КОМПЛЕКТ БОРФРЕЗИ ЗА ДЪРВО



5x



№ 21450
Характеристики
Ø 8 mm

10



КОМПЛЕКТ БОРФРЕЗИ ЗА ДЪРВО



12x

№ 21451
Характеристики
Ø 8 mm



10



КОМПЛЕКТ БОРФРЕЗИ ЗА ДЪРВО



24x

№ 21452
Характеристики
Ø 8 mm



1

КОМПЛЕКТ
БОРФРЕЗИ ЗА ДЪРВО



35x

№ 21453
Характеристики
Ø 8 mm



1



КОМПЛЕКТ
БОРФРЕЗИ ЗА ДЪРВО



59x

№ 21454
Характеристики
Ø 8 mm



1



FESTA

СВРЕДЛО ЗА БЕТОН

DIN 8039



· Двойно острие



№	Характеристики	A mm	B mm	
20673	Ø 3 mm	60	30	100
20674	Ø 4 mm	75	40	100
20675	Ø 5 mm	85	50	100
20676	Ø 6 mm	100	60	100
20677	Ø 6 mm	200	160	50
20685	Ø 6 mm	300	260	50
20678	Ø 8 mm	120	75	50
20686	Ø 8 mm	200	155	50

№	Характеристики	A mm	B mm	
20687	Ø 8 mm	300	255	25
20688	Ø 8 mm	400	340	25
20680	Ø 10 mm	120	70	50
20690	Ø 10 mm	200	150	50
20691	Ø 10 mm	300	250	25
20692	Ø 10 mm	400	340	25
20682	Ø 12 mm	150	100	50
20694	Ø 12 mm	300	250	25

№	Характеристики	A mm	B mm	
20696	Ø 12 mm	400	340	25
20684	Ø 14 mm	150	90	25
Редукция Ø 10 mm				
20697	Ø 14 mm	300	240	5
Редукция Ø 10 mm				
20698	Ø 14 mm	400	340	15
Редукция Ø 10 mm				

FESTA

СВРЕДЛО ЗА БЕТОН, SDS+

SDS+



· Двойно острие



№	Характеристики	A mm	B mm	
20855	Ø 14 mm	160	75	

№	Характеристики	A mm	B mm	
				25

FESTA

СВРЕДЛО ЗА БЕТОН, SDS+

SDS+

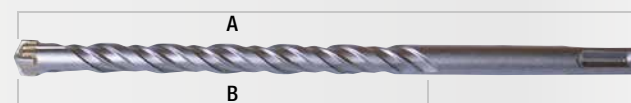

· 4 остриета за по-висока ефективност и издръжливост



№	Характеристики	A mm	B mm	
20748	Ø 6 mm	110	40	50
20749	Ø 6 mm	160	90	50
20750	Ø 6 mm	210	140	50
20751	Ø 6 mm	260	190	50
20861	Ø 6,5 mm	230	160	50
20862	Ø 6,5 mm	300	230	50
20752	Ø 8 mm	110	40	50
20753	Ø 8 mm	160	90	50
20754	Ø 8 mm	210	140	50
20755	Ø 8 mm	260	190	50
20825	Ø 8 mm	350	280	50
20756	Ø 10 mm	160	90	50
20757	Ø 10 mm	210	140	50
20758	Ø 10 mm	260	190	50
20759	Ø 10 mm	350	280	50
20760	Ø 10 mm	450	380	50
20761	Ø 10 mm	600	530	50
20762	Ø 10 mm	1000	930	50
20764	Ø 12 mm	160	80	50
20765	Ø 12 mm	210	130	50
20766	Ø 12 mm	260	180	50
20767	Ø 12 mm	350	270	50

№	Характеристики	A mm	B mm	
20768	Ø 12 mm	460	380	50
20769	Ø 12 mm	600	520	25
20770	Ø 12 mm	1000	920	25
20771	Ø 14 mm	160	80	25
20772	Ø 14 mm	260	180	25
20773	Ø 14 mm	350	270	25
20774	Ø 14 mm	460	380	25
20775	Ø 14 mm	600	520	25
20776	Ø 14 mm	1000	920	30
20777	Ø 16 mm	160	80	25
20778	Ø 16 mm	210	130	25
20779	Ø 16 mm	260	180	25
20780	Ø 16 mm	350	270	25
20781	Ø 16 mm	460	380	25
20782	Ø 16 mm	600	520	30
20783	Ø 16 mm	1000	920	25
20784	Ø 18 mm	260	180	25
20785	Ø 18 mm	450	370	25
20786	Ø 18 mm	600	520	32
20787	Ø 18 mm	1000	920	20
20788	Ø 20 mm	450	370	20
20789	Ø 20 mm	600	520	20

№	Характеристики	A mm	B mm	
20790	Ø 20 mm	800	720	25
20791	Ø 20 mm	1000	920	10
20792	Ø 22 mm	450	365	20
20793	Ø 22 mm	600	520	20
20794	Ø 22 mm	800	715	20
20795	Ø 22 mm	1000	920	10
20796	Ø 24 mm	450	365	10
20797	Ø 24 mm	600	520	20
20798	Ø 24 mm	800	715	10
20799	Ø 24 mm	1000	920	10
20870	Ø 26 mm	450	370	10
20871	Ø 26 mm	650	570	20
20872	Ø 26 mm	800	720	10
20873	Ø 26 mm	1000	920	10
20874	Ø 28 mm	450	365	10
20875	Ø 28 mm	600	565	20
20876	Ø 28 mm	800	715	10
20877	Ø 28 mm	1000	915	10
20878	Ø 30 mm	450	365	10
20879	Ø 30 mm	600	565	20
20880	Ø 30 mm	800	715	10
20881	Ø 30 mm	1000	915	10

FESTA

УДЪЛЖЕНО СВРЕДЛО ЗА ТУХЛИ И БЕТОН, SDS+

SDS MAX

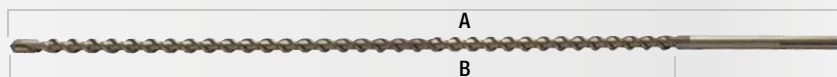

· 4 остриета за по-висока ефективност и издръжливост



№	Характеристики	A mm	B mm	
20508	Ø 16 mm	550	395	5
20510	Ø 18 mm	550	395	5
20520	Ø 18 mm	800	650	5
20511	Ø 20 mm	550	395	5
20521	Ø 20 mm	800	650	5

№	Характеристики	A mm	B mm	
20512	Ø 22 mm	550	395	5
20522	Ø 22 mm	800	650	5
20513	Ø 24 mm	550	395	5
20523	Ø 24 mm	800	650	5
20514	Ø 28 mm	550	395	5

№	Характеристики	A mm	B mm	
20524	Ø 28 mm	800	650	5
20515	Ø 30 mm	550	395	5
20525	Ø 30 mm	800	650	5
20516	Ø 40 mm	550	395	2
20526	Ø 40 mm	800	650	1

КОМПЛЕКТ СВРЕДЛА ЗА ТУХЛИ И БЕТОН, SDS+

5x SDS+



№	Характеристики	1
20890	Ø 5, 6, 8, 10, 12 mm 160 mm	25



РЕКЛАМЕН СТЕЛАЖ

№	Характеристики	1
20999		1



КОМПЛЕКТ СВРЕДЛА ЗА ТУХЛИ И БЕТОН, SDS+

6x SDS+



№	Характеристики	1
20891	Ø 5, 6, 8 mm 110 mm Ø 8, 10, 12 mm 160 mm	25



FESTA

КОМПЛЕКТ СВРЕДЛА И ДЛЕТА, SDS+

- 2 x секач
- 3 x длето
- 12 x свредло Ø 5-12 mm

17x SDS+



№	Характеристики	1
20952		1



КОМПЛЕКТ СВРЕДЛА ЗА ТУХЛИ И БЕТОН

6x DIN 8039



№	Характеристики	1
20895	Ø 5, 6, 8, 10, 12 mm	25



FESTA

КОМПЛЕКТ СВРЕДЛА И ДЛЕТА, SDS+

- 1 x длето 250 mm
- 1 x кухо длето 22 x 250 mm
- 1 x плоско длето 20 x 250 mm

- Ø 5 x 110 mm
- Ø 6 x 110 mm
- Ø 8 x 160 mm
- Ø 10 x 160 mm
- Ø 12 x 160 mm
- Ø 14 x 210 mm
- Ø 16 x 210 mm
- Ø 18 x 310 mm
- Ø 20 x 450 mm

12x SDS+



№	Характеристики	1
20950		5



КОМПЛЕКТ СВРЕДЛА ЗА ТУХЛИ



№	Характеристики	1
20805	5 бр. Ø 4 - 10 mm	10
20820	8 бр. Ø 3 - 10 mm	10



FESTA

КОМПЛЕКТ ДЛЕТА

SDS+

4x



№	Характеристики	1
20954	250 mm	1

FESTA

ПЛОСКО ДЛЕТО

SDS+



№	Характеристики	1
20996	250 x 100 mm	1



NEW



FESTA

ПЛОСКО ДЛЕТО

SDS+

№	Характеристики	Кол-во
20997	445 x 130 mm	1

NEW

FESTA

ПЛОСКО ДЛЕТО

SDS MAX

№	Характеристики	Кол-во
20932	450 x 100 mm	1



FESTA

ПЛОСКО ДЛЕТО, 15°

SDS+

№	Характеристики	Кол-во
20936	40 x 250 mm	5

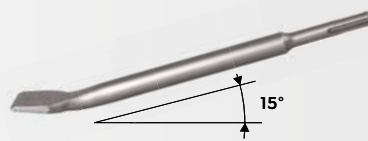

FESTA

ПЛОСКО ДЛЕТО

SDS+

№	Характеристики	Кол-во
20948	20 x 250 mm	25
20990	20 x 400 mm	25
20949	40 x 250 mm	25
20991	40 x 400 mm	25



FESTA

ПЛОСКО ДЛЕТО

SDS MAX

№	Характеристики	Кол-во
20940	25 x 280 mm	5
20941	40 x 280 mm	5
20942	75 x 280 mm	5
20943	25 x 400 mm	5
20944	40 x 400 mm	5
20945	25 x 600 mm	5
20946	50 x 600 mm	5



FESTA

ДЛЕТО ТИП ШИЛО

SDS+

№	Характеристики	Кол-во
20947	250 mm	25
20992	400 mm	25



FESTA

ДЛЕТО ТИП ШИЛО

SDS MAX

№	Характеристики	Кол-во
20937	∅ 18 x 280 mm	5
20938	∅ 18 x 400 mm	5
20939	∅ 18 x 600 mm	2



FESTA

ДЛЕТО КАНАЛОКОПАЧ

SDS+

№	Характеристики	Кол-во
20956	22 x 250 mm	25



FESTA

БОРКОРОНА С ТВЪРДОСПЛАВНИ ПЛАСТИНИ ЗА БЕТОН И ЗИДАРИЯ

• водач за боркорона 24730, 24731 и 24732

SDS+

№	Характеристики	Кол-во
24719	∅ 67 mm	1
24717	∅ 73 mm	1
24723	∅ 80 mm	1
24718	∅ 100 mm	1
24757	∅ 115 mm	1
24758	∅ 125 mm	1
24759	∅ 150 mm	1



SDS MAX

№	Характеристики	Кол-во
24730	180 mm	1

FESTA

ВОДАЧ ЗА БОРКОРОНА



FESTA

ВОДАЧ ЗА БОРКОРОНА

SDS+

№	Характеристики	Кол-во
24731	300 mm	1
24732		1





FESTA

КОМПЛЕКТ БОРКОРОНИ ЗА ФАЯНС И ТЕРАКОТ



6x



№	Характеристики	
24745	Ø 33, 53, 67, 73 mm + държач, борфреза	1

FESTA

КОМПЛЕКТ БОРКОРОНИ ЗА ФАЯНС И ТЕРАКОТ



8x

№	Характеристики	
24747	Ø 33, 53, 67, 73, 83 mm Държач, борфреза, пила	1



FESTA

БОРКОРОНА ЗА ФАЯНС И ТЕРАКОТ



№	Характеристики	
24735	Ø 33 mm	1
24736	Ø 43 mm	1
24737	Ø 53 mm	1
24738	Ø 67 mm	1
24739	Ø 73 mm	1
24740	Ø 83 mm	1
24741	Ø 103 mm	1



FESTA

КОМПЛЕКТ БОРКОРОНИ ЗА ФАЯНС И ТЕРАКОТ

3x



№	Характеристики	
24746	Ø 103 mm + държач, борфреза	1



FESTA

БОРФРЕЗА



№	Характеристики	
24749		50



FESTA

ДЪРЖАЧ



№	Характеристики	
24748	Ø 33 - 83 mm	10
24743	Ø 33 - 103 mm	10



FESTA

БОРКОРОНА - КАРБИД

- За стъкло и керамика
- С необходимост от охлаждане



№	Характеристики	
24770	Ø 4 mm	1
24771	Ø 6 mm	1
24772	Ø 8 mm	1
24773	Ø 10 mm	1
24774	Ø 12 mm	1



БОРКОРОНА С КАПАК

№	Характеристики	
24726	Ø 20-95mm	1



БОРКОРОНА

№	Характеристики	
24725	Ø 20-95mm	10



FESTA

ДИАМАНТЕНА ПИЛА, ЗАОБЛЕНА, ЗА ФАЯНС И ДР.



№	Характеристики	
22200	160 mm	20



FESTA

ДИАМАНТЕНА ПИЛА, ПЛОСКА, ЗА ФАЯНС И ДР.

- За шлифоване на тухли преди поставяне на анкер



№	Характеристики	
22201	200 mm Двустранно	20





**БОРКОРОНА
С ДИАМАНТЕНО ПОКРИТИЕ**

- Ø 6 mm
- Ø 8 mm
- Ø 10 mm
- Ø 12 mm
- Ø 20 mm
- Ø 28 mm
- Ø 35 mm
- Ø 45 mm
- Ø 55 mm
- Ø 68 mm



диск за рязане / шлифоване ø 125 mm x 2,0 mm ø 22,2 mm
диск за рязане ø 125 mm x 1,2 mm ø 22,2 mm
боркорона с диамантено покритие ø 0 - 50 mm
диамантена абразивна ъба 90 x 55 mm P60

13x M14

- Керамични плочки
- Мрамор
- Гранит

• Без необходимост от охлаждане



№	Характеристики	
24652		1



БОРКОРОНА С ДИАМАНТЕНО ПОКРИТИЕ

M14

- Керамични плочки
- Мрамор
- Гранит

• Без необходимост от охлаждане



№	Характеристики	
24620	Ø 6 mm	M14
24621	Ø 8 mm	M14
24622	Ø 10 mm	M14
24623	Ø 12 mm	M14
24624	Ø 14 mm	M14
24627	Ø 20 mm	M14
24630	Ø 28 mm	M14
24633	Ø 35 mm	M14
24636	Ø 45 mm	M14
24638	Ø 55 mm	M14
24640	Ø 68 mm	M14
24642	NEW Ø 72 mm	M14
24643	Ø 75 mm	M14



**БОРКОРОНА С ДИАМАНТЕНО
ПОКРИТИЕ**

- Ø 6 mm
- Ø 8 mm
- Ø 10 mm
- Ø 20 mm
- Ø 35 mm
- Ø 45 mm
- Ø 55 mm
- Ø 68 mm



8x M14

- Керамични плочки
- Мрамор
- Гранит

• Без необходимост от охлаждане



№	Характеристики	
24651		1



ДИАМАНТЕНА ШЛАЙФАЦА КОРОНА

M14

- Керамични плочки
- Мрамор
- Гранит

• Без необходимост от охлаждане



№	Характеристики	
24795	Ø 20 / 50 mm	1
24797	Ø 6 / 50 mm	1
24799	Ø 10 / 50 mm	1



**БОРКОРОНА
С ДИАМАНТЕНО ПОКРИТИЕ**

M14

- Керамични плочки
- Мрамор
- Гранит

• Без необходимост от охлаждане



№	Характеристики	
24775	NEW Ø 2 - 35 mm	1
24777	Ø 2 - 75 mm	1
24778	Ø 2 - 50 mm	1



БОРКОРОНА С ДИАМАНТЕНО ПОКРИТИЕ

M14

- Керамични плочки
- Мрамор
- Гранит

- Без необходимост от охлаждане



№	Характеристики	Уч. №
24779	Ø 20 - 48 mm	1



ДИАМАНТЕНА ШЛАЙФАЦА КОРОНА

M14

- Керамични плочки
- Мрамор
- Гранит

- Без необходимост от охлаждане



№	Характеристики	Уч. №
24663	Ø 50 mm	1



БОРКОРОНА С ДИАМАНТЕНО ПОКРИТИЕ

M14

- Керамични плочки
- Мрамор
- Гранит

- Без необходимост от охлаждане



№	Характеристики	Уч. №	Уч. №	№	Характеристики	Уч. №	Уч. №
24760	Ø 6 mm	M14	1	24766	Ø 35 mm	M14	1
24761	Ø 8 mm	M14	1	24776	Ø 40 mm	M14	1
24762	Ø 10 mm	M14	1	24767	Ø 45 mm	M14	1
24763	Ø 12 mm	M14	1	24791	Ø 50 mm	M14	1
24764	Ø 14 mm	M14	1	24768	Ø 53 mm	M14	1
24670	Ø 16 mm	M14	1	24792	Ø 60 mm	M14	1
24671	Ø 18 mm	M14	1	24793	Ø 65 mm	M14	1
24790	Ø 20 mm	M14	1	24769	Ø 68 mm	M14	1
24672	Ø 22 mm	M14	1	24794	Ø 75 mm	M14	1
24673	Ø 25 mm	M14	1	24796	Ø 83 mm	M14	1
24765	Ø 28 mm	M14	1	24677	Ø102 mm	M14	1
24674	Ø 30 mm	M14	1	24676	Ø 110 mm	M14	1
24675	Ø 32 mm	M14	1	24678	Ø125 mm	M14	1



ДИАМАНТЕНА ШЛАЙФАЦА КОРОНА

M14

- Керамични плочки
- Мрамор
- Гранит

- Без необходимост от охлаждане



№	Характеристики	Уч. №
24661	Ø 50 mm	1



БОРКОРОНА С ДИАМАНТЕНО ПОКРИТИЕ

7x M14

- Керамични плочки
- Мрамор
- Гранит

- Без необходимост от охлаждане



№	Характеристики	Уч. №
24650		1



БОРКОРОНА С ДИАМАНТЕНО ПОКРИТИЕ

- Керамични плочки
- Мрамор
- Гранит

№	Характеристики	Уч. №
24700	Ø 6 mm	1
24701	Ø 8 mm	1
24702	Ø 10 mm	1
24703	Ø 12 mm	1
24704	Ø 14 mm	1
24705	Ø 20 mm	1



FESTA

ОХЛАЖДАЩ ВОСЪК
ЗА ДИАМАНТЕН
ТРИОН



№	Характеристики	
24710	30 ml	1

FESTA

БОРКОРОНА
С ДИАМАНТЕНО
ПОКРИТИЕ



6x

- Керамични плочки
- Мрамор
- Гранит

№	Характеристики	
24798	Ø 6, 8, 10, 12, 14, 20 mm	1



FESTA

БОРКОРОНА
ДИАМАНТЕН
ДИСК

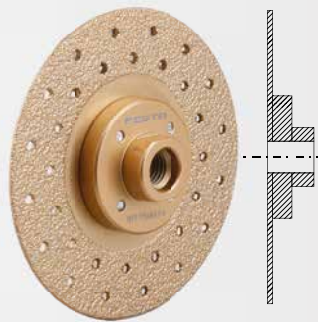

M14

- Керамични плочки
- Мрамор
- Гранит

- Без необходимост от охлаждане

№	Характеристики	
24655	Ø 115 mm M14	1

FESTA

БОРКОРОНА
ДИАМАНТЕН
ДИСК

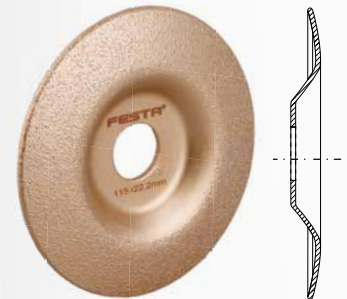

- Керамични плочки
- Мрамор
- Гранит

- Без необходимост от охлаждане

№	Характеристики	
24658	Ø 115 mm Ø 22,2 mm	1

FESTA

БОРФРЕЗА ЗА СТЪКЛО И
КЕРАМИКА

TiN 1/4"

- Керамични плочки
- Мрамор
- Гранит

№	Характеристики	
24780	Ø 4 mm	40
24781	Ø 5 mm	40
24782	Ø 6 mm	40
24783	Ø 8 mm	40
24784	Ø 10 mm	40
24785	Ø 12 mm	40
24786	Ø 14 mm	1
24787	Ø 16 mm	1
24788	Ø 18 mm	1
24789	Ø 20 mm	1



FESTA

БОРФРЕЗА ЗА СТЪКЛО И
КЕРАМИКА - КОМПЛЕКТ

- Ø 4 mm
- Ø 5 mm
- Ø 6 mm
- Ø 8 mm
- Ø 10 mm

5x

- Керамични плочки
- Мрамор
- Гранит

- Без необходимост от охлаждане

№	Характеристики	
24734		1



FESTA
INDUSTRY



FESTA
INDUSTRY

ДИАМАНТЕН ДИСК ЗА РЯЗАНЕ / ШЛИФОВАНЕ

- Керамични плочки
- Мрамор
- Гранит
- Без необходимост от охлаждане



FESTA
INDUSTRY

ДИАМАНТЕН ДИСК ЗА РЯЗАНЕ ТУРБО

- Керамични плочки
- Мрамор
- Гранит
- Без необходимост от охлаждане

№	Характеристики		
21230	Ø 115 mm x 1,8 mm	Ø 22,2 mm	1
21231	Ø 125 mm x 2,0 mm	Ø 22,2 mm	1

№	Характеристики		
21205	Ø 125 mm x 2,0 mm	Ø 22,2 mm	1
21209	Ø 230 mm x 2,6 mm	Ø 22,2 mm	1

FESTA
INDUSTRY

ДИАМАНТЕН ДИСК ЗА РЯЗАНЕ

- Керамични плочки
- Мрамор
- Гранит
- Без необходимост от охлаждане



FESTA
INDUSTRY

ДИАМАНТЕН ДИСК FESTA INDUSTRY

- Керамични плочки
- Мрамор
- Гранит
- Без необходимост от охлаждане

№	Характеристики		
21234 NEW	Ø 115 mm x 1,2 x 8 mm	Ø 22,2 mm	1
21235	Ø 125 mm x 1,2 x 8 mm	Ø 22,2 mm	1
21238 NEW	Ø 200 mm x 1,6 x 11 mm	Ø 25,4 mm	1

№	Характеристики		
21200	Ø 115 mm 1,4 mm	Ø 22,2 mm	1
21201	Ø 125 mm 1,4 mm	Ø 22,2 mm	1
21204	Ø 200 mm 1,8 mm	Ø 25,4 mm	1
21203	Ø 230 mm 1,8 mm	Ø 22,2 mm	1



FESTA

ДИАМАНТЕН ДИСК СЪС СЕГМЕНТИРАНЕ

№	Характеристики		
21311	Ø 115 mm	Ø 22,2 mm	1
21312	Ø 125 mm	Ø 22,2 mm	1
21315	Ø 150 mm	Ø 22,2 mm	1
21318	Ø 180 mm	Ø 22,2 mm	1
21323	Ø 230 mm	Ø 22,2 mm	1
21324	Ø 300 mm	Ø 25,4 mm	1
21327	Ø 350 mm	Ø 25,4 mm	1
21326	Ø 400 mm	Ø 25,4 mm	1



FESTA

ДИАМАНТЕН ДИСК ТУРБО

№	Характеристики		
21411	Ø 115 mm	Ø 22,2 mm	1
21412	Ø 125 mm	Ø 22,2 mm	1
21415	Ø 150 mm	Ø 22,2 mm	1
21418	Ø 180 mm	Ø 22,2 mm	1
21423	Ø 230 mm	Ø 22,2 mm	1
21424	Ø 300 mm	Ø 25,4 mm	1



FESTA

ДИАМАНТЕН ДИСК, ЦЯЛ

№	Характеристики		
21210	Ø 110 mm	Ø 22,2 mm	1
21211	Ø 115 mm	Ø 22,2 mm	1
21212	Ø 125 mm	Ø 22,2 mm	1
21215	Ø 150 mm	Ø 22,2 mm	1
21218	Ø 180 mm	Ø 22,2 mm	1
21219	Ø 180 mm	Ø 25,4 mm	1
21220	Ø 200 mm	Ø 25,4 mm	1
21223	Ø 230 mm	Ø 22,2 mm	1
21224	Ø 300 mm	Ø 25,4 mm	1



FESTA
INDUSTRY

УНИВЕРСАЛЕН ДИАМАНТЕН ДИСК ЗА РЯЗАНЕ



№	Характеристики		
21301	Ø 125 mm	Ø 22,2 mm	1,5 mm
21303	Ø 230 mm	Ø 22,2 mm	1,8 mm



FESTA

ДИАМАНТЕН ДИСК СЪС СЕГМЕНТИРАНЕ НА РЕЖЕЩИЯ РЪБ, ДВОЕН



№	Характеристики		
21195	Ø 125 x 22,2 mm		1

6 mm



ДИАМАНТЕН ДИСК, ЦЯЛ

№	Характеристики		
21010	Ø 110 mm	Ø 22,2 mm	1
21011	Ø 115 mm	Ø 22,2 mm	1
21012	Ø 125 mm	Ø 22,2 mm	1
21015	Ø 150 mm	Ø 22,2 mm	1
21018	Ø 180 mm	Ø 22,2 mm	1
21023	Ø 230 mm	Ø 22,2 mm	1



ДИАМАНТЕН ДИСК СЪС СЕГМЕНТИРАНЕ

№	Характеристики		
21110	Ø 110 mm	Ø 22,2 mm	1
21111	Ø 115 mm	Ø 22,2 mm	1
21112	Ø 125 mm	Ø 22,2 mm	1
21115	Ø 150 mm	Ø 22,2 mm	1
21118	Ø 180 mm	Ø 22,2 mm	1
21123	Ø 230 mm	Ø 22,2 mm	1



ДИАМАНТЕН ДИСК ТУРБО

№	Характеристики		
21130	Ø 110 mm	Ø 22,2 mm	1
21135	Ø 115 mm	Ø 22,2 mm	1
21140	Ø 125 mm	Ø 22,2 mm	1
21150	Ø 150 mm	Ø 22,2 mm	1
21180	Ø 180 mm	Ø 22,2 mm	1
21190	Ø 230 mm	Ø 22,2 mm	1



FESTA

ДИАМАНТЕН ДИСК ЗА ШЛИФОВАНЕ



№	Характеристики		
21435	Ø 115 mm	Ø 22,2 mm	1
21436	Ø 125 mm	Ø 22,2 mm	1
21437	Ø 150 mm	Ø 22,2 mm	1



FESTA

ДИАМАНТЕН ДИСК ЗА ШЛИФОВАНЕ, ДВУРЕДЕН



№	Характеристики		
21430	Ø 115 mm	Ø 22,2 mm	1
21431	Ø 125 mm	Ø 22,2 mm	1
21432	Ø 150 mm	Ø 22,2 mm	1



FESTA

ДИАМАНТЕН ДИСК ЗА ШЛИФОВАНЕ ТУРБО



№	Характеристики		
21425	Ø 100 mm	Ø 22,2 mm	1
21426	Ø 115 mm	Ø 22,2 mm	1
21427	Ø 125 mm	Ø 22,2 mm	1
21428	Ø 150 mm	Ø 22,2 mm	1



FESTA INDUSTRY

ДИСК ЗА РЯЗАНЕ НА МЕТАЛ



№	Характеристики		
22258	Ø 115 mm	Ø 22,2 mm x 0,8 mm	25
22260	Ø 115 mm	Ø 22,2 mm x 1 mm	25
22263	Ø 115 mm	Ø 22,2 mm x 1,6 mm	25
22264	Ø 115 mm	Ø 22,2 mm x 2 mm	25
22259	Ø 125 mm	Ø 22,2 mm x 0,8 mm	25
22266	Ø 125 mm	Ø 22,2 mm x 1 mm	25
22269	Ø 125 mm	Ø 22,2 mm x 1,6 mm	25
22270	Ø 125 mm	Ø 22,2 mm x 2 mm	25
22273	Ø 150 mm	Ø 22,2 mm x 1,6 mm	25
22274	Ø 150 mm	Ø 22,2 mm x 2 mm	25
22275	Ø 150 mm	Ø 22,2 mm x 2,5 mm	25
22277	Ø 180 mm	Ø 22,2 mm x 2 mm	25
22280	Ø 230 mm	Ø 22,2 mm x 2 mm	25
22281	Ø 230 mm	Ø 22,2 mm x 2,5 mm	25

FESTA INDUSTRY

ДИСК ЗА РЯЗАНЕ НА АЛУМИНИЙ



№	Характеристики		
22285	Ø 115 mm	Ø 22,2 mm x 1 mm	1
22286	Ø 125 mm	Ø 22,2 mm x 1 mm	1

FESTA INDUSTRY

ДИСК ЗА РЯЗАНЕ НА КАМЪК



№	Характеристики		
22294	Ø 230 mm	Ø 22,2 mm x 3 mm	1

FESTA

ДИСК ЗА РЯЗАНЕ НА МЕТАЛ



№	Характеристики			
22211	Ø 115 mm	Ø 22,2 mm x 1 mm	INOX	50
22212	Ø 115 mm	Ø 22,2 mm x 1,2 mm	INOX	50
22225	Ø 125 mm	Ø 22,2 mm x 1 mm	INOX	50
22217	Ø 125 mm	Ø 22,2 mm x 1,2 mm	INOX	50

FESTA

ДИСК ЗА РЯЗАНЕ НА МЕТАЛ

10x



№	Характеристики			
22228	Ø 115 mm	Ø 22,2 mm x 1 mm	INOX	1
22229	Ø 125 mm	Ø 22,2 mm x 1,2 mm	INOX	1

FESTA

ДИСК ЗА РЯЗАНЕ НА МЕТАЛ

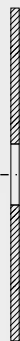

№	Характеристики			
22251	Ø 115 mm	Ø 22,2 mm x 1,6 mm		50
22215	Ø 115 mm	Ø 22,2 mm x 2 mm		50
22216	Ø 115 mm	Ø 22,2 mm x 2,5 mm		50
22252	Ø 125 mm	Ø 22,2 mm x 1,6 mm		25
22218	Ø 125 mm	Ø 22,2 mm x 2,5 mm		25
22219	Ø 150 mm	Ø 22,2 mm x 1,2 mm		25
22253	Ø 150 mm	Ø 22,2 mm x 1,6 mm		50
22220	Ø 150 mm	Ø 22,2 mm x 2,5 mm		50
22254	Ø 180 mm	Ø 22,2 mm x 1,6 mm		50
22222	Ø 180 mm	Ø 22,2 mm x 2,5 mm		25
22255	Ø 230 mm	Ø 22,2 mm x 1,6 mm		25
22224	Ø 230 mm	Ø 22,2 mm x 2,5 mm		25

FESTA

ДИСК ЗА ШЛИФОВАНЕ НА МЕТАЛ

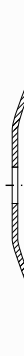

№	Характеристики			
22240	Ø 115 mm	Ø 22,2 mm x 6,4 mm		25
22242	Ø 125 mm	Ø 22,2 mm x 6,4 mm		25
22244	Ø 150 mm	Ø 22,2 mm x 6,4 mm		25
22246	Ø 180 mm	Ø 22,2 mm x 6,4 mm		25
22248	Ø 230 mm	Ø 22,2 mm x 6,4 mm		25

FESTA

ДИАМАНТЕН ДИСК ЗА РЯЗАНЕ НА МЕТАЛ

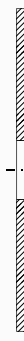

№	Характеристики			
21306	Ø 125 mm	Ø 22,2 mm x 1,3 mm		1
21308	Ø 230 mm	Ø 22,2 mm x 1,8 mm		1

FESTA

ДИСК ЗА РЯЗАНЕ НА КАМЪК



№	Характеристики			
22230	Ø 115 mm	Ø 22,2 mm x 2,5 mm		50
22232	Ø 125 mm	Ø 22,2 mm x 2,5 mm		50
22234	Ø 150 mm	Ø 22,2 mm x 2,5 mm		25
22236	Ø 180 mm	Ø 22,2 mm x 2,5 mm		25
22238	Ø 230 mm	Ø 22,2 mm x 2,5 mm		25

FESTA

УНИВЕРСАЛЕН ДИСК ЗА РЯЗАН КАРБИД



№	Характеристики			
21192	Ø 125 mm	Ø 22,2 mm		1
21194	Ø 230 mm	Ø 22,2 mm		1

FESTA

ДИСК РАШПИЛА
ЗА ДЪРВО



№	Характеристики			Икон
21806	Ø 125 mm	Ø 22,2 mm	1	



FESTA

ДИСК РАШПИЛА
ЗА ДЪРВО,
ГРУБИ НАСЕЧКИ



№	Характеристики			Икон
21802	Ø 125 mm	Ø 22,2 mm	3 mm	

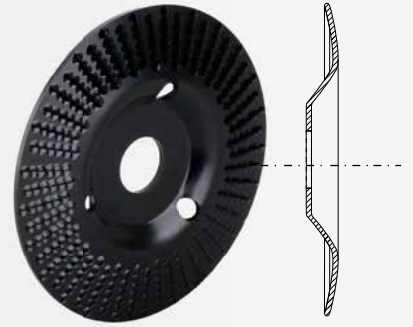

FESTA

ДИСК РАШПИЛА
ЗА ДЪРВО,
СРЕДНО
ГРУБИ НАСЕЧКИ



№	Характеристики			Икон
21801	Ø 125 mm	Ø 22,2 mm	3 mm	



FESTA

ДИСК РАШПИЛА
ЗА ДЪРВО,
ГРУБИ НАСЕЧКИ



№	Характеристики			Икон
21803	Ø 125 mm	Ø 22,2 mm	1	

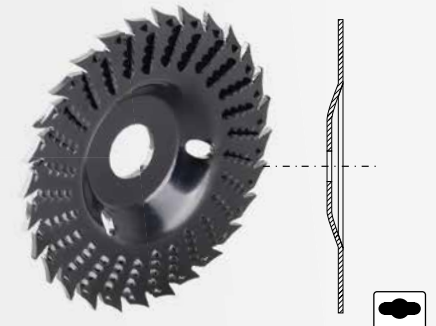

NEW

FESTA

ДИСК РАШПИЛА
ЗА ДЪРВО



№	Характеристики			Икон
21805	Ø 125 mm	Ø 22,2 mm	1	



FESTA

ДИСК ЗА ДЪРВО



№	Характеристики			Икон
21800	Ø 125 mm	Ø 22,2 mm	1	

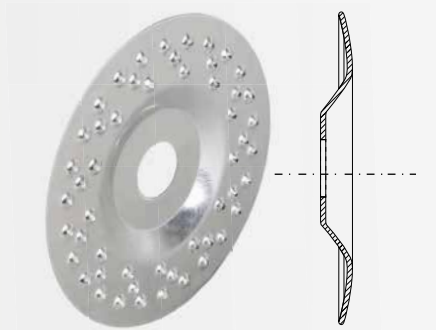

· Диск за шлифоване на дърво

FESTA

БОРФРЕЗИ

M14



№	Характеристики			Икон
21807	Ø 30 mm / 60 mm		1	

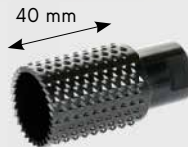

FESTA

БОРФРЕЗИ

M14



№	Характеристики			Икон
21808	Ø 30 mm / 105 mm		10	



ДИСК ЗА РЯЗАНЕ
ЗА ДЪРВО



№	Характеристики			Икон
21804	Ø 125 mm	Ø 22,2 mm	14T	

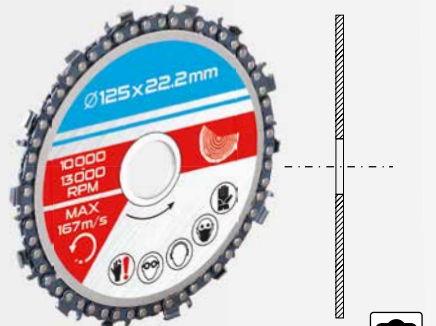

NEW

ДИСК
ЗА РЯЗАНЕ
ЗА ДЪРВО



№	Характеристики		
21809	Ø 125 mm x 4T	Ø 22,2 mm	1

NEW

FESTA
INDUSTRY

ЛАМЕЛЕН ДИСК
ДИАМАНТЕН



- Керамични плочки
- Мрамор
- Гранит



- Без необходимост от охлаждане

№	Характеристики				
24647	Ø 115 mm	Ø 22,2 mm	● P60		1
24648	Ø 115 mm	Ø 22,2 mm	● P120		1
24649	Ø 115 mm	Ø 22,2 mm	● P200		1

NEW

FESTA

ЛАМЕЛЕН
ДИСК



INOX



№	Характеристики		Гравовост	
21760	Ø 125 mm	Ø 22,2 mm	P40	10
21761	Ø 125 mm	Ø 22,2 mm	P60	10
21762	Ø 125 mm	Ø 22,2 mm	P80	10
21763	Ø 125 mm	Ø 22,2 mm	P100	10
21764	Ø 125 mm	Ø 22,2 mm	P120	10

FESTA

ЛАМЕЛЕН ДИСК

· Диск за шлифоване на неръждаема стомана



INOX

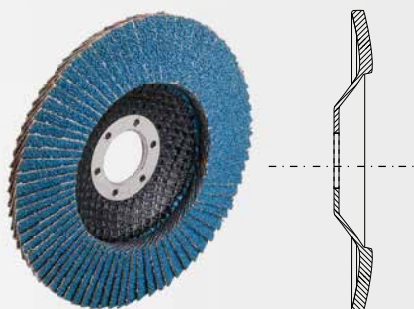

№	Характеристики		Гравовост	
22140	Ø 115 mm	Ø 22,2 mm	P40	5
22141	Ø 115 mm	Ø 22,2 mm	P60	5
22142	Ø 115 mm	Ø 22,2 mm	P80	5
22143	Ø 115 mm	Ø 22,2 mm	P100	5
22145	Ø 125 mm	Ø 22,2 mm	P40	5
22146	Ø 125 mm	Ø 22,2 mm	P60	5
22147	Ø 125 mm	Ø 22,2 mm	P80	5
22148	Ø 125 mm	Ø 22,2 mm	P100	5
22150	Ø 150 mm	Ø 22,2 mm	P40	5
22151	Ø 150 mm	Ø 22,2 mm	P60	5
22155	Ø 150 mm	Ø 22,2 mm	P80	5
22156	Ø 150 mm	Ø 22,2 mm	P100	5

ЛАМЕЛЕН ДИСК



№	Характеристики		Гравовост	
21780	Ø 115 mm	Ø 22,2 mm	P40	10
21781	Ø 115 mm	Ø 22,2 mm	P60	10
21782	Ø 115 mm	Ø 22,2 m	P80	10
21783	Ø 115 mm	Ø 22,2 mm	P100	10
21784	Ø 115 mm	Ø 22,2 mm	P120	10
21786	Ø 125 mm	Ø 22,2 mm	P40	10
21787	Ø 125 mm	Ø 22,2 mm	P60	10
21788	Ø 125 mm	Ø 22,2 mm	P80	10
21789	Ø 125 mm	Ø 22,2 mm	P100	10
21790	Ø 125 mm	Ø 22,2 mm	P120	10
21792	Ø 150 mm	Ø 22,2 mm	P40	10
21793	Ø 150 mm	Ø 22,2 mm	P60	10
21794	Ø 150 mm	Ø 22,2 mm	P80	10
21795	Ø 150 mm	Ø 22,2 mm	P100	10
21796	Ø 150 mm	Ø 22,2 mm	P120	10

НАЙЛОНОВ ДИСК
ЗА ШЛИФОВАНЕ,
С ПОДЛОЖКА



№	Характеристики		
21798	Ø 125 mm	Ø 22,2 mm	1



FESTA



20mm

FESTA
СКОСЕНА ЧЕТКА, МЕСИНГОВО ПОКРИТИЕ

· Месингово покритие

M14

№	Характеристики	Тел	пакет
21900	Ø 100 mm M14	s 0,3	60
21902	Ø 125 mm M14	s 0,3	42



10mm

FESTA
СКОСЕНА ЧЕТКА, МЕСИНГОВО ПОКРИТИЕ

· Месингово покритие

M14

№	Характеристики	Тел	пакет
22001	Ø 100 mm M14	s 0,3	60
21901	Ø 125 mm M14	s 0,3	42

FESTA
СКОСЕНА ЧЕТКА, МЕСИНГ

· Месинг

M14

№	Характеристики	Тел	пакет
21920	Ø 100 mm M14	s 0,3	60

FESTA
ЧЕТКА ТИП КАМБАНА, МЕСИНГОВО ПОКРИТИЕ

· Месингово покритие

M14

№	Характеристики	Тел	пакет
21903	Ø 65 mm M14	s 0,3	60
22002	Ø 75 mm M14	s 0,3	80
21904	Ø 85 mm M14	s 0,3	60
22003	Ø 100 mm M14	s 0,3	36
21905	Ø 125 mm M14	s 0,3	24
21906	Ø 150 mm M14	s 0,3	12

FESTA
ЧЕТКА ТИП КАМБАНА, МЕСИНГ

· Месинг

M14

№	Характеристики	Тел	пакет
21925	Ø 75 mm M14	0,3 mm	80
21926	Ø 100 mm M14	0,3 mm	36

FESTA
КРЪГЛА ЧЕТКА, МЕСИНГОВО ПОКРИТИЕ

· Месингово покритие

· Редуциращи пръстени

№	Характеристики	Тел	пакет
22007	Ø 100 mm Ø 20 mm	s 0,3	60
22008	Ø 125 mm Ø 20 mm	s 0,3	42
22009	Ø 150 mm Ø 32,2 mm	s 0,3	32
22010	Ø 175 mm Ø 32,2 mm	s 0,3	20
22011	Ø 200 mm Ø 32,2 mm	s 0,3	20

FESTA
ЧЕТКА ТИП КАМБАНА, УСУКАН ТЕЛ, INOX

· Закалена

INOX M14

№	Характеристики	Тел	пакет
22037	Ø 65 mm M14	s 0,5	60
22038	Ø 80 mm M14	s 0,5	24

FESTA
ЧЕТКА ТИП КАМБАНА, УСУКАН ТЕЛ

· Закалена

M14

№	Характеристики	Тел	пакет
22004	Ø 65 mm M14	s 0,3	60
22005	Ø 75 mm M14	s 0,3	24
22006	Ø 100 mm M14	s 0,3	24
21907	Ø 125 mm M14	s 0,3	24
21908	Ø 150 mm M14	s 0,3	12

FESTA
КРЪГЛА ЧЕТКА, УСУКАН ТЕЛ

· Закалена

M14

№	Характеристики	Тел	пакет	сopу
21911	Ø 100 mm M14	s 0,5	30	60
21912	Ø 115 mm M14	s 0,5	32	42
21913	Ø 125 mm M14	s 0,5	36	42
21914	Ø 150 mm M14	s 0,5	40	32



FESTA

КРЪГЛА ЧЕТКА, УСУКАН ТЕЛ

· Закалена

M14



№	Характеристики	Тел	Тел
22012	Ø 100 mm M14	s 0,5	60
22013	Ø 115 mm M14	s 0,5	42
22014	Ø 125 mm M14	s 0,5	42
22015	Ø 150 mm M14	s 0,5	32
22016	Ø 178 mm M14	s 0,5	20



FESTA

КРЪГЛА ЧЕТКА, УСУКАН ТЕЛ

· Закалена

INOX M14



№	Характеристики	Тел	Тел
22039	Ø 100 mm M14	s 0,5	60
22040	Ø 125 mm M14	s 0,5	42



FESTA

СКОСЕНА ЧЕТКА, УСУКАН ТЕЛ

· Закалена

M14



№	Характеристики	Тел	Тел
22017	Ø 100 mm M14	s 0,5	60
21909	Ø 115 mm M14	s 0,5	42
21910	Ø 125 mm M14	s 0,5	42



Ø 6 mm

FESTA

СКОСЕНА ЧЕТКА, УСУКАН ТЕЛ, С ДРЪЖКА

· Закалена



№	Характеристики	Тел	Тел
22023	Ø 75 mm	s 0,5	10



Ø 6 mm

FESTA

ЧЕТКА ТИП КАМБАНА, УСУКАН ТЕЛ, С ДРЪЖКА

· Закалена



№	Характеристики	Тел	Тел
22024	Ø 75 mm	s 0,5	12



Ø 6 mm

FESTA

СКОСЕНА ЧЕТКА, УСУКАН ТЕЛ, С ДРЪЖКА

· Закалена



№	Характеристики	Тел	Тел
22025	Ø 75 mm	s 0,5	12

NEW



FESTA

КРЪГЛА ЧЕТКА, УСУКАН ТЕЛ



№	Характеристики	Тел	Тел
21950	Ø 200 mm 25,4 mm		1



Ø 6 mm

FESTA

ЧЕТКА ТИП КАМБАНА, МЕСИНГОВО ПОКРИТИЕ

· Месингово покритие



№	Характеристики	Тел	Тел
22030	Ø 65 mm	s 0,3	12
22031	Ø 75 mm	s 0,3	12



Ø 6 mm

FESTA

КРЪГЛА ЧЕТКА, МЕСИНГОВО ПОКРИТИЕ

· Месингово покритие



№	Характеристики	Тел	Тел
22026	Ø 50 mm	s 0,3	15
22027	Ø 63 mm	s 0,3	15
22028	Ø 75 mm	s 0,3	10
22029	Ø 100 mm	s 0,3	15



Ø 6 mm

FESTA

КОНУСОВИДНА ЧЕТКА, С ДРЪЖКА



№	Характеристики	Тел	Тел
22058	Ø 12 mm	s 0,3	25
22059	Ø 25 mm	s 0,3	25



Ø 6 mm

FESTA

КОНУСОВИДНА ЧЕТКА, С ДРЪЖКА, МЕСИНГ

· Месингово покритие



№	Характеристики	Тел	Тел
22018	Ø 12 mm	s 0,3	15
22019	Ø 17 mm	s 0,3	15
22020	Ø 25 mm	s 0,3	25



Ø 6 mm

FESTA

КОНУСОВИДНА ЧЕТКА, УСУКАНА ТЕЛ

· Закалена



№	Характеристики	Тел	Тел
22021	Ø 19 mm	s 0,5	30
22022	Ø 22 mm	s 0,5	25



FESTA

НАЙЛОНОВА ЧЕТКА ТИП КАМБАНА



№	Характеристики	Тел	Грановост
21940	Ø 75 mm M14	1,2 mm	1
21941	Ø 100 mm M14	1,2 mm	1



FESTA

КРЪГЛА НАЙЛОНОВА ЧЕТКА



№	Характеристики	Тел	Грановост
21930	Ø 125 mm M14	1,2 mm	10
21931	Ø 150 mm M14	1,2 mm	15

Ø 6 mm



FESTA

НАЙЛОНОВА ЧЕТКА НА СНОПОВЕ, С ДРЪЖКА



№	Характеристики	Тел	Грановост
22032	Ø 100 mm	1,2 mm	12

Ø 6 mm

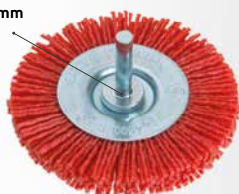

FESTA

НАЙЛОНОВА ЧЕТКА ТИП КАМБАНА



№	Характеристики	Тел	Грановост
21935	Ø 50 mm	1,2 mm	15
21936	Ø 75 mm	1,2 mm	10
21937	Ø 100 mm	1,2 mm	15



Ø 6 mm

НАЙЛОНОВ ДИСК ЗА ШЛИФОВАНЕ, С ДРЪЖКА



№	Характеристики	Грановост
22088	Ø 65 mm	9
22090	Ø 100 mm	5



НАЙЛОНОВ ДИСК ЗА ШЛИФОВАНЕ, С ПОДЛОЖКА



№	Характеристики	Грановост
22083	Ø 115 mm Ø 22,2 mm	10
22084	Ø 125 mm Ø 22,2 mm	10
22085	Ø 150 mm Ø 22,2 mm	10



НАЙЛОНОВ ДИСК ЗА ШЛИФОВАНЕ



№	Характеристики	Грановост
22095	Ø 178 mm	1

NEW

FESTA

ДИАМАНТЕНО КОЛЕЛО ЗА ШЛИФОВАНЕ С ВЕЛКРО

- Керамични плочки
- За стъкло
- Мрамор
- Гранит



· подложка 22043

№	Характеристики	Грановост	Грановост
24665	Ø 100 mm	● P60	10
24666	Ø 100 mm	● P120	10
24667	Ø 100 mm	● P200	10

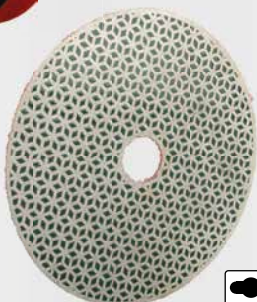

FESTA

ДИАМАНТЕНО ПОЛИРАЩО КОЛЕЛО Ø 100 MM, С ВЕЛКРО

- Керамични плочки
- За стъкло
- Мрамор
- Гранит



· подложка 22043

№	Грановост	Грановост
22701	50	1
22702	100	1
22703	200	1
22704	400	1
22705	800	1
22706	1500	1
22707	3000	1



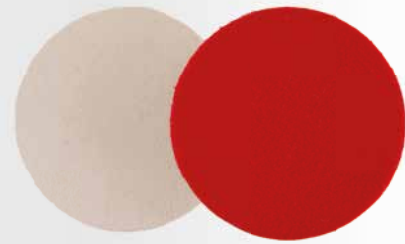

КЕЧЕ ЗА ПОЛИРАНЕ

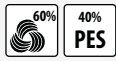

№	Характеристики	Характеристики	Пакет
22065	Ø 125 mm	с велкро	20
22066	Ø 150 mm	с велкро	20

КЕЧЕ ЗА ПОЛИРАНЕ С ВЕЛКРО



№	Характеристики	Пакет
22070	Ø 115 mm	20
22071	Ø 125 mm с велкро	20
22072	Ø 150 mm	20

FESTA

ПОДЛОЖКА С ВЕЛКРО

- M14 | Ø 8 mm
- EVA 10 mm

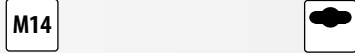

№	Характеристики	Пакет
22062	Ø 115 mm	25
22063	Ø 125 mm	25
22064	Ø 150 mm	10

FESTA

ПОДЛОЖКА ЗА РАБОТА С ФИБЪР ДИСК

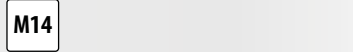

№	Характеристики	Пакет
22073	Ø 125 mm, M14	1
22074	Ø 150 mm, M14	1



FESTA

ПОДЛОЖКА

- За ъглошлайф
- за 24665-24667, 22701-22707

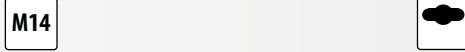

№	Характеристики	Пакет
22043	Ø 100 mm с велкро	1

ПОДЛОЖКА

- За ъглошлайф

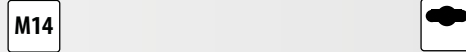

№	Характеристики	Пакет
22044	Ø 125 mm M14 с велкро	15
22060	Ø 150 mm M14 с велкро	6

АДАПТЕР



№	Характеристики	Пакет
22087		1



ПОДЛОЖКА

№	Характеристики	Пакет
22061	Ø 125 mm с велкро	6

ПОДЛОЖКА

№	Характеристики	Пакет
22041	Ø 125 mm С винт	11
22042	Ø 125 mm с велкро	11



№	Характеристики	Пакет
22091	Ø 50 mm P240	1
22092	Ø 75 mm P240	1
22093	Ø 100 mm P240	1

FESTA

ФИБЪР ДИСК - Ø 125 MM



№	Гравовост	Пакет
22160	P40	1
22161	P60	1
22162	P80	1
22163	P100	1
22164	P120	1



FESTA

ФИБЪР ДИСК - Ø 125 MM







№	Гравовост	Пакет
22167	P80	1



FESTA

ШКУРКА С ВЕЛКРО, Ø 125 MM

3x

№	Гранавост				
22045	P40				1
22046	P60				1
22047	P80				1
22048	P100				1
22049	P120				1
22050	P150				1
22051	P180				1
22052	P220				1

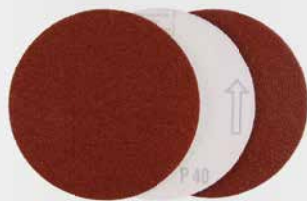
**FESTA**

ШКУРКА С ВЕЛКРО, Ø 150 MM

3x

№	Гранавост				
22053	P40				1
22054	P60				1
22055	P80				1
22056	P100				1
22057	P120				1

**FESTA**ШКУРКА ЗА ВИБРОШЛАЙФ, OSA,
94 X 94 X 94 MM



5x

№	Гранавост				
21831	P60				1
21832	P80				1
21834	P120				1

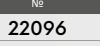
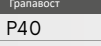

ШКУРКА С ВЕЛКРО, 125 MM

3x

№	Гранавост				
22096	P40				20
22097	P60				20
22098	P80				20
22099	P120				20

FESTAШКУРКА ЗА ЛЕНТОВ ШЛАЙФ,
75 X 533 MM



3x

№	Гранавост				
21810	P40				20
21811	P60				20
21812	P80				20
21813	P100				20
21814	P120				20



ЛИСТ ЗА ПОЛИРАНЕ С ВЕЛКРО, 93 X 230 MM

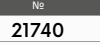
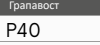

5x

№	Гранавост					брой дупки
21740	P40				20	8
21741	P60				20	8
21742	P80				20	8
21743	P100				20	8
21744	P120				20	8



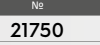
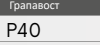

ЛИСТ ЗА ПОЛИРАНЕ С ВЕЛКРО, 115 X 280 MM

5x

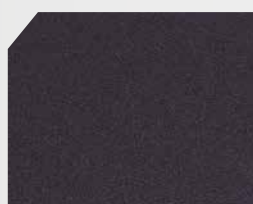
№	Гранавост					брой дупки
21750	P40				20	10
21751	P60				20	10
21752	P80				20	10
21753	P100				20	10
21754	P120				20	10

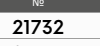
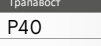

ШКУРКА ЗА ПОЛИРАНЕ,
230 X 280 MM

10x

№	Гранавост				
21732	P40				1
21734	P60				1
21735	P80				1
21736	P100				1
21737	P120				1

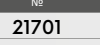
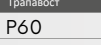

ВОДОУСТОЙЧИВА ШКУРКА,
230 X 280 MM

10x

№	Гранавост				
21701	P60				1
21702	P80				1
21703	P100				1
21704	P120				1
21705	P150				1
21706	P180				1
21709	P240				1

ВОДОУСТОЙЧИВА ШКУРКА,
230 X 280 MM

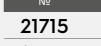
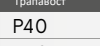
10x

№	Гранавост				
21715	P40				1
21716	P60				1
21717	P80				1
21718	P100				1
21719	P120				1
21720	P150				1
21721	P180				1
21724	P240				1

NEW



FESTA

ДЪРЖАЧ
ЗА ШКУРКА

· Ø 150 mm



№	Характеристики	1
22119		1

FESTA

ДЪРЖАЧ
ЗА ШКУРКА

· Бързо захващане



№	Характеристики	10
22067	170 x 70 mm	10

ДЪРЖАЧ
ЗА ШКУРКА



№	Характеристики	100
22075	210 x 105 mm	100
22076	160 x 85 mm	100

ДЪРЖАЧ
ЗА ШКУРКА



№	Характеристики	10
22077	125 x 68 mm	10

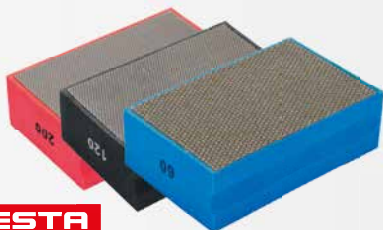

FESTA

ДИАМАНТЕНА АБРАЗИВНА
ГЪБА

· 90 x 55 x 25 mm

· Керамични плочки
· За стъкло
· Мрамор
· Гранит



ЛАМЕЛЕН ДИСК ЗА ШЛИФОВАНЕ
С ДРЪЖКА

№	Грапавост	Характеристики	1
21850	P40		1
21851	P60		1
21852	P80	20 x 20, Ø 6 mm	1
21853	P100		1
21854	P120		1
21855	P40		1
21856	P60		1
21857	P80	30x30, Ø 6mm	1
21858	P100		1
21859	P120		1
21860	P40		1
21861	P60		1
21862	P80	60x30, Ø 6mm	1
21863	P100		1
21864	P120		1



FESTA

ГЪБА ЗА ШЛИФОВАНЕ 100 X 70 X 28 MM
СКОСЕНА



№	Грапавост	10
22106	P 60	10
22107	P 80	10
22108	P 100	10
22109	P 120	10



FESTA

ГЪБА ЗА ШЛИФОВАНЕ,
100 X 70 X 25 MM



№	Грапавост	20
22100	P60	20
22101	P80	20
22102	P100	20
22103	P120	20
22104	P180	20
22105	P220	20



FESTA

ГЪБА ЗА ШЛИФОВАНЕ
120 X 95 X 10 MM



№	Грапавост	20
22110	P80	20
22111	P120	20
22112	P180	20
22113	P220	20



FESTA



№	Характеристики	Брой зъби	
Ø 115 mm			
22300	Ø 115 x 22 mm	40	1
Ø 125 mm			
22301	Ø 125 x 22 mm	40	1
Ø 140 mm			
22302	Ø 140 x 20 mm	24	1
22303	Ø 140 x 20 mm	30	1
Ø 150 mm			
22305	Ø 150 x 20 mm	24	1
Ø 160 mm			
22307	Ø 160 x 20 mm	18	1
22309	Ø 160 x 20 mm	24	1
22310	Ø 160 x 20 mm	30	1
22311	Ø 160 x 20 mm	36	1
22312	Ø 160 x 20 mm	48	1
22313	Ø 160 x 20 mm	60	1
Ø 165 mm			
22314	Ø 165 x 20 mm	24	1
Ø 180 mm			
22315	Ø 180 x 30 mm	24	1
22317	Ø 180 x 30 mm	50	1
22318	Ø 180 x 20 mm	50	1
Ø 185 mm			
22316	Ø 185 x 20 mm	24	1
Ø 190 mm			
22319	Ø 190 x 20 mm	40	1
22320	Ø 190 x 30 mm	40	1
Ø 200 mm			
22322	Ø 200 x 30 mm	24	1
22324	Ø 200 x 30 mm	40	1
22326	Ø 200 x 30 mm	60	1
Ø 205 mm			
22328	Ø 205 x 30 mm	40	1
22329	Ø 205 x 30 mm	60	1
Ø 210 mm			
22332	Ø 210 x 30 mm	40	1
22333	Ø 210 x 30 mm	60	1
Ø 250 mm			
22335	Ø 250 x 30 mm	40	1
22337	Ø 250 x 30 mm	60	1
Ø 300 mm			
22340	Ø 300 x 30 mm	40	1
22343	Ø 300 x 30 mm	60	1
22345	Ø 300 x 30 mm	96	1
Ø 350 mm			
22350	Ø 350 x 30 mm	40	1
22351	Ø 350 x 30 mm	54	1
Ø 400 mm			
22355	Ø 400 x 30 mm	40	1
22357	Ø 400 x 30 mm	60	1
Ø 500 mm			
22365	Ø 500 x 30 mm	60	1
Ø 600 mm			
22370	Ø 600 x 30 mm	60	1



FESTA

ДИСК ЗА ЦИРКУЛЯР (ЗА ДЪРВО)

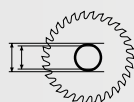
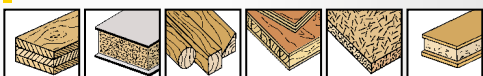

РЕДУКЦИОНЕН ПРЪСТЕН

№	Характеристики	
22399	Ø 20 16 mm	1
22398	Ø 30 25 mm	1

FESTA

ОСЦИЛИРАЩ КОМПЛЕКТ АКСЕСОАРИ
ЗА МНОГОФУНКЦИОНАЛНИ ИНСТРУМЕНТИ

за 28045



4x

3x BI-METAL



1x SK5

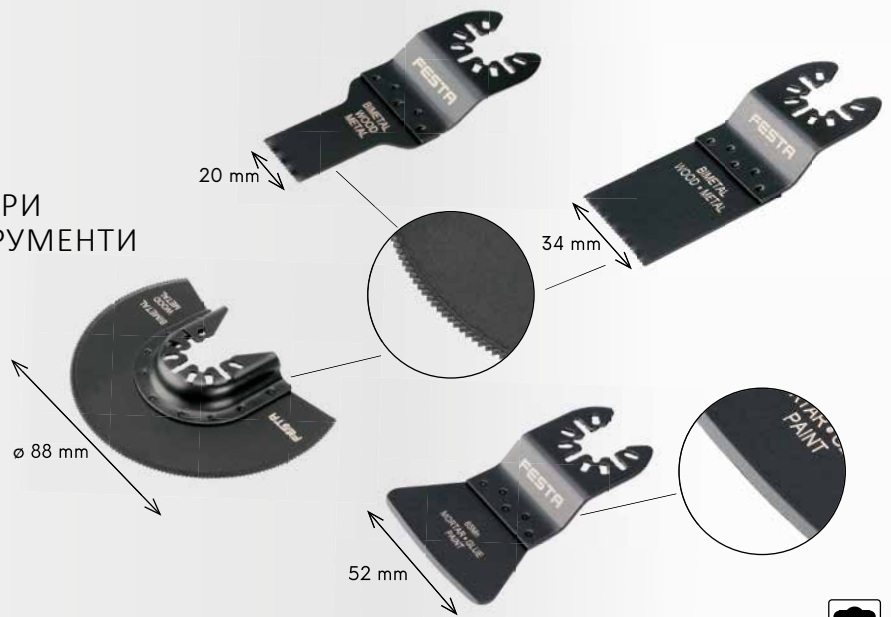

№ Характеристики

24322

10

FESTA

ОСЦИЛИРАЩ КОМПЛЕКТ АКСЕСОАРИ
ЗА МНОГОФУНКЦИОНАЛНИ ИНСТРУМЕНТИ

за 28045



4x

3x CARBIDE



1x

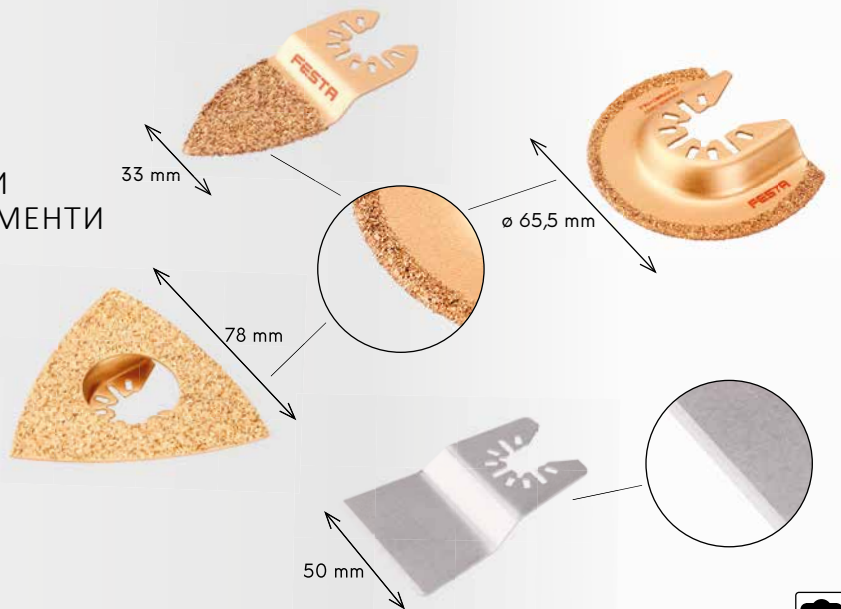

№ Характеристики

24321

10

ОСЦИЛИРАЩ КОМПЛЕКТ АКСЕСОАРИ
ЗА МНОГОФУНКЦИОНАЛНИ ИНСТРУМЕНТИ

за 28045



HCS 3x

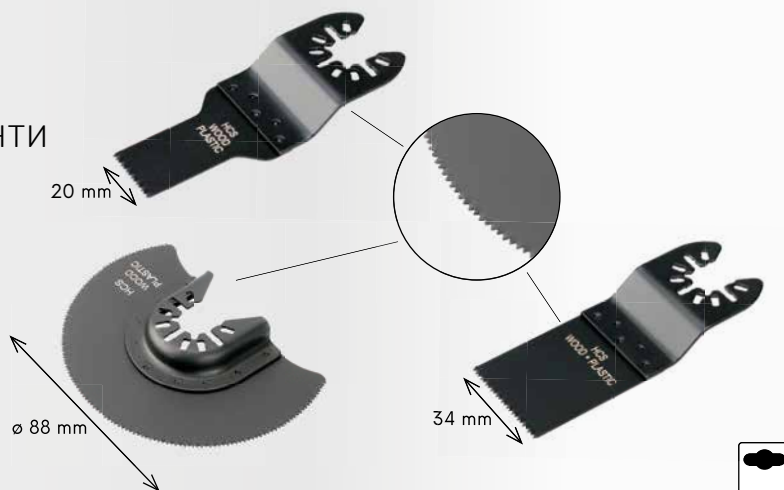

№ Характеристики

24320

10

НОЖОВЕ ЗА САБЛЕНИ ТРИОДНИ, ПРОИЗВЕДЕНИ В ГЕРМАНИЯ ЧРЕЗ ТЕХНОЛОГИЯ НА ЛАЗЕРНО ГОРЕНЕ



НОЖОВЕ ЗА САБЛЕНИ ТРИОНИ HSS, ПОДХОДЯЩИ ЗА AEG, BOSCH, FESTO, МАКИТА, МЕТАВО

	24060	50mm/1mm	0,7 mm/ 36TPI	31007	5 бр.	10	
	24061	50mm/1mm	1,2 mm/ 21TPI	31012	5 бр.	10	
	24062	50mm/1mm	2,0 mm/ 13TPI	31020	5 бр.	10	
	24063	75mm/1mm	3,0 mm/ 8TPI	31030	5 бр.	10	
	24064	100mm/1mm	1,2 mm/ 21TPI	31112	5 бр.	10	
	24065	100mm/1,3mm	2,0 mm/ 13TPI	31112	5 бр.	10	
	24066	75mm/1,45mm	2,0 mm/ 13TPI	31220	5 бр.	10	
	24067	120mm/1,3mm	1,8 - 2,4 mm/ 10 - 14 TPI	31220	5 бр.	10	
	24068	75mm/1,45mm	2,5 mm/ 10 TPI	32225	5 бр.	10	
	24069	75mm/1,45mm	4 mm/ 6 TPI	32240	5 бр.	10	
	24070	75mm/1,3mm	4 mm/ 6 TPI	32340	5 бр.	10	
	24071	75mm/1,3mm	4 mm/ 6 TPI	32440	5 бр.	10	
	24072	75mm/1,45mm	2,5 mm/ 10 TPI	32625	5 бр.	10	
	24073	85mm/1,45mm	3 mm/ 8 TPI	32730	5 бр.	10	
	24074	85mm/1,45mm	4 mm/ 6 TPI	32730	5 бр.	10	
	24075	75mm/1,45mm	2,5 1,2 mm/10 21 TPI	32825	5 бр.	10	
	24076	75mm/1,7mm	4 mm 6 TPI	32940	5 бр.	10	
	24077	120mm/1,3mm	4 mm 6 TPI	32040	5 бр.	10	
	24078	105mm/1,45mm	4 mm 6 TPI	34040	5 бр.	10	
	24055	55mm	Карбиден		5 бр.	1	

НОЖОВЕ ЗА САБЛЕНИ ТРИОНИ HSS, ПОДХОДЯЩИ ЗА BLACK & DECKER, FERM

	24080	50mm 1,0 mm	1,2 21 TPI	11012	5 бр.	10	
	24081	75mm 1,0 mm	3,0 8 TPI	11030	5 бр.	10	
	24082	75mm 1,45 mm	2,5 10 TPI	12225	5 бр.	10	
	24083	75mm 1,45 mm	4 6 TPI	12240	5 бр.	10	
	24084	75mm 1,3 mm	4 6 TPI	12340	5 бр.	10	
	24085	50mm 1,0 mm	2,0 13 TPI	12420	5 бр.	10	
	24086	75mm 1,3 mm	4,0 6 TP	12440	5 бр.	10	
	24087	75mm 1,45 mm	2,5 10 TPI	12625	5 бр.	10	

	Мека стомана (нисковъглеродна)		Листов материал (ламарина)		Нерждаема стомана		Ламинирани плоскости
	Цветни метали		Мека и твърда дървесина		Талашит		Пластмаса
	Шперплат		ПДЧ		Дърво с пирони		
	Сандвич панел		Настилки и облицовки		Алуминий		

СТЕЛАЖ ЗА НОЖОВЕ

- Артикули на стелажа 24098- 24060 · 5 бр.
- 24080 · 5 бр.
- 24061 · 5 бр.
- 24062 · 5 бр.
- 24081 · 5 бр.
- 24063 · 5 бр.
- 24066 · 5 бр.
- 24067 · 5 бр.
- 24082 · 5 бр.
- 24068 · 5 бр.
- 24083 · 5 бр.
- 24069 · 5 бр.
- 24084 · 5 бр.
- 24070 · 5 бр.
- 24086 · 5 бр.
- 24071 · 5 бр.
- 24087 · 5 бр.
- 24072 · 5 бр.
- 24073 · 5 бр.
- 24074 · 5 бр.
- 24075 · 5 бр.
- 24076 · 5 бр.



КОМПЛЕКТ НОЖОВЕ ЗА САБЛЕН ТРИОН



5x



№	Характеристики	50
24045	sada	50

№	Характеристики	1
24099	64 x 50 cm - Без остриета	1
24098	64 x 50 cm - С остриета	1

FESTA

НОЖОВЕ ЗА САБЛЕНИ ТРИОНИ

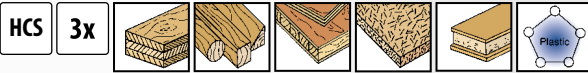

№ Характеристики
24301 150 x 19 x 1,3 mm TPI 6



1

FESTA

НОЖОВЕ ЗА САБЛЕНИ ТРИОНИ

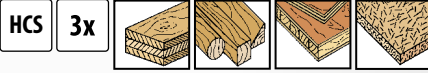

№ Характеристики
24302 225 x 19 x 1,3 mm TPI 3



1

FESTA

НОЖОВЕ ЗА САБЛЕНИ ТРИОНИ

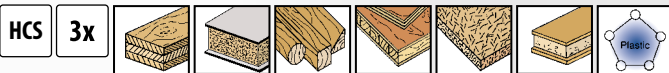

№ Характеристики
24303 200 x 19 x 1,3 mm TPI 6 - 10



1

FESTA

НОЖОВЕ ЗА САБЛЕНИ ТРИОНИ

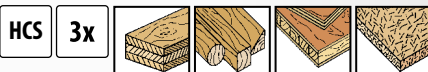

№ Характеристики
24304 240 x 19 x 1,5 mm TPI 5



1

FESTA

НОЖОВЕ ЗА САБЛЕНИ ТРИОНИ

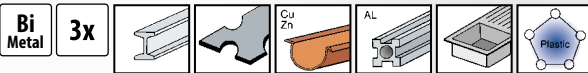

№ Характеристики
24305 150 x 19 x 1 mm TPI 24

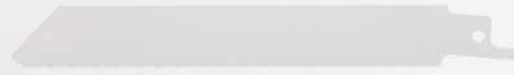

1

FESTA

НОЖОВЕ ЗА САБЛЕНИ ТРИОНИ

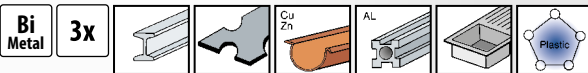

№ Характеристики
24306 150 x 19 x 1 mm TPI 9



1

FESTA

НОЖОВЕ ЗА САБЛЕНИ ТРИОНИ

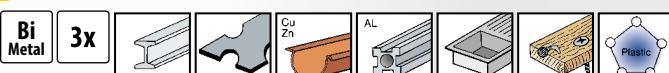

№ Характеристики
24308 225 x 19 x 1 mm TPI 10 - 14

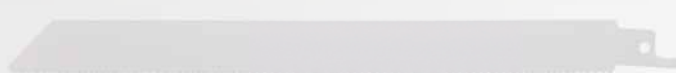

1

FESTA

НОЖОВЕ ЗА САБЛЕНИ ТРИОНИ



№ Характеристики
24310 150 x 22 x 1,6 mm TPI 9



1

FESTA

НОЖОВЕ ЗА САБЛЕНИ ТРИОНИ

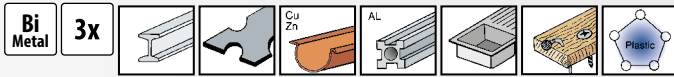

№	Характеристики	
24313	225 x 22 x 1,6 mm TPI 6	1

FESTA

НОЖОВЕ ЗА САБЛЕНИ ТРИОНИ

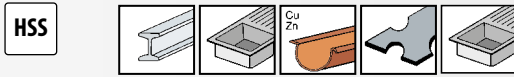

№	Характеристики	
24050	203 x 19 x 1 mm TPI 10 - 14	25

FESTA

НОЖОВЕ ЗА САБЛЕНИ ТРИОНИ

· Карбидна технология

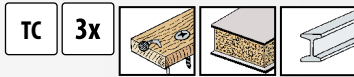

№	Характеристики	
24312	225 x 19 x 1,3 mm TPI 6 - 9	1

FESTA

НОЖОВЕ ЗА САБЛЕНИ ТРИОНИ



№	Характеристики	
24315	305 x 50 x 1,5 mm	1
24316	455 x 50 x 1,5 mm	25

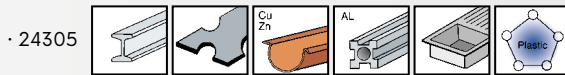
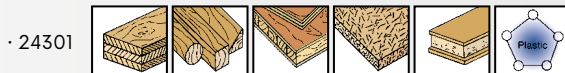

FESTA

КОМПЛЕКТ НОЖОВЕ ЗА САБЛЕН ТРИОН



№	Характеристики	
24314		1



FESTA

ДРЪЖКА ЗА ТРИОНИ

· дръжка + 2x трион
· за саблен трион



№	Характеристики	
24325		1





FESTA
INDUSTRY



РЕЗЕРВЕН РЕЖЕЩ ЛИСТ ЗА ТРИОН (ДЪРВО)

· Закалени зъби



№	Характеристики	
24185	533 mm	1
24186	610 mm	1
24187	760 mm	1
24188	800 mm	1
24189	914 mm	1



РЕЗЕРВЕН РЕЖЕЩ ЛИСТ ЗА ТРИОН (ДЪРВО)

· Закалени зъби



№	Характеристики	
24169	350 mm	10
24167	450 mm	10
24166	533 mm	10
24163	610 mm	10
24164	760 mm	10
24168	800 mm	10
24165	914 mm	10



РЕЖЕЩ ЛИСТ ЗА НОЖОВКА



№	Характеристики	
24195	Стъпка 3 mm 300 mm	1
24196	Стъпка 4 mm 300 mm Скосени зъби	1
24197	Стъпка 5 mm 300 mm Закалени зъби	1
24192	Нож за месарски трион 450 mm	1

РЕЖЕЩ ЛИСТ ЗА НОЖОВКА

№	Характеристики	
24160	Стъпка 3 mm 300 mm	20
24161	Стъпка 4 mm 300 mm	20
24162	Стъпка 5 mm 300 mm	50



РЕЖЕЩ ЛИСТ ЗА НОЖОВКА

10x



№	Характеристики	
24108	6 mm 150 mm	1

РЕЖЕЩА СТРУНА, ДИАМАНТЕНА



№	Характеристики	
24120	300 mm	50



РЕЖЕЩ ЛИСТ ЗА НОЖОВКА, БИ МЕТАЛ

· 8 % кобалт



№	Характеристики	
24180	300 mm	125



РЕЖЕЩ ЛИСТ ЗА НОЖОВКА



№	Характеристики	
24109	12,5 mm 300 mm За метал	144
24118	25 mm 300 mm За метал, двустранен	72
24119	25 mm 300 mm За метал и дърво	72





96

ИЗМЕРВАТЕЛНИ РОЛЕТКИ



101

СГЪВАЕМИ МЕТРИ



104

ПРАВИ ЪГЛИ



106

НИВЕЛИРИ



112

ПРОДУЛАЗЕРНИ
ИЗМЕРВАТЕЛНИ УРЕДИ

116

МОЛИВИ И МАРКЕРИ



120

СПРЕЙОВЕ



122

МАКЕТНИ НОЖОВЕ



137

КЛЕЩИ РЕЗАЧКИ ЗА PVC
ТРЪБИ

140

ОТВЕРТКИ



146

БИТОВЕ



154

КОМПЛЕКТИ ГЕДОРЕ



159

ВЛОЖКИ, УДЪЛЖЕНИЯ,
АДАПТЕРИ

164

ГАЕЧНИ КЛЮЧОВЕ



169

КЛЕЩИ



179

НОЖИЦИ



182

НИТАЧКИ



188

ПИЛИ И РАШПИЛИ



190

ТРИОНИ ЗА ДЪРВО, МЕТАЛ
И ДРУГИ

195

ЧУКОВЕ



203

ФИКСИРАЩИ СТЯГИ

РЪЧНИ ИНСТРУМЕНТИ 94 - 205



КОМЕЛОП®

· ВИСОКОКАЧЕСТВЕНО ИЗМЕРВАНЕ И ПРЕЦИЗНОСТ

- Стандарти ČSN 251104, EEC 755345
- Найлоново покритие на лентата DURA NY Coat™, гарантиращо до 10 пъти по-висока устойчивост



· Износоустойчиво найлоново покритие DURA NY Coat™

КОМЕЛОП® ИЗМЕРВАТЕЛНА РОЛЕТКА



№	Характеристики	
10002	2 m · 16 mm	10
10003	3 m · 16 mm	10
10005	5 m · 19 mm	10
10008	8 m · 25 mm	10



· Износоустойчиво найлоново покритие DURA NY Coat™

КОМЕЛОП® ИЗМЕРВАТЕЛНА РОЛЕТКА



№	Характеристики	
10025	5 m · 25 mm	10



· Износоустойчиво найлоново покритие DURA NY Coat™

КОМЕЛОП® ИЗМЕРВАТЕЛНА РОЛЕТКА

- Автоматичен стоп
- Гумирано покритие



№	Характеристики	
10033	3 m · 16 mm	6
10035	5 m · 19 mm	6



КОМЕЛОП® ИЗМЕРВАТЕЛНА РОЛЕТКА



№	Характеристики	
10043	3 m · 16 mm	30
10045	5 m · 19 mm	30
10048	8 m · 25 mm	12



КОМЕЛОП® ИЗМЕРВАТЕЛНА РОЛЕТКА ОТ СТОМАНА



№	Характеристики	
10110	10 m · 10 mm	6
10120	20 m · 10 mm	6
10130	30 m · 10 mm	6



КОМЕЛОП® ИЗМЕРВАТЕЛНА РОЛЕТКА ОТ ФИБРОСТЪКЛО, ЛАМИНИРАНА



№	Характеристики	
10330	10 m · 13 mm	6
10332	20 m · 13 mm	6
10334	30 m · 13 mm	6
10336	50 m · 13 mm	6



КОМЕЛОП®

ИЗМЕРВАТЕЛНА РОЛЕТКА ОТ
ФИБРОСТЪКЛО, ЛАМИНИРАНА



№	Характеристики	
10430	30 m · 13 mm	1
10450	50 m · 13 mm	1
10490	100 m · 13 mm	1



· Снимката е илюстративна.

**РЕКЛАМЕН
СТЕЛАЖ**

№	Характеристики	
10998		1

КОМЕЛОП®

РЕКЛАМЕН СТЕЛАЖ

· Артикули за стелаж No. 10996

- 10003 · 5 бр.
- 10005 · 4 бр.
- 10008 · 1 бр.
- 10033 · 2 бр.
- 10035 · 3 бр.
- 10045 · 2 бр.
- 10025 · 3 бр.
- 10110 · 1 бр.
- 10120 · 1 бр.
- 10130 · 1 бр.
- 10430 · 1 бр.
- 10330 · 1 бр.
- 10332 · 1 бр.
- 10334 · 1 бр.
- 10336 · 1 бр.



· Снимката е илюстративна.

№	Характеристики	
10999	Рекламен стелаж	1
10996	Рекламен стелаж с артикули	1



· Информация за лентата



- A** 5m · Дължина на лентата
- B** · Клас точност
- C** · Сертификат CE
- D** · Година на производство
- E** · Номер на сертификата
- F** · Производител
- G** · Специални настройки на лентата
- H** · Температура по време на тестване

FESTA



FESTA

ИЗМЕРВАТЕЛНА РОЛЕТКА

- Скала с големи числа
- Гумирано покритие
- Найлоново покритие



№	Характеристики	
11353	3 m · 19 mm	12
11355	5 m · 19 mm	12
11356	5 m · 25 mm	12
11358	8 m · 25 mm	6
11360	10 m · 25 mm	6



FESTA

ИЗМЕРВАТЕЛНА РОЛЕТКА

- Найлоново покритие
- Корпус ABS
- Хромирана метална скоба
- Автоматичен стоп
- Гумирано покритие PTE
- Държач



№	Характеристики	
11343	3 m · 16 mm	6
11345	5 m · 19 mm	6
11347	7,5 m · 25 mm	6



FESTA

ИЗМЕРВАТЕЛНА РОЛЕТКА

- 3 x стоп
- Магнитна кука
- Стопер
- Гумирано покритие

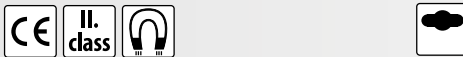

№	Характеристики	
11323	3 m · 19 mm	10
11325	5 m · 25 mm	10
11327	7,5 m · 25 mm	6



FESTA

ИЗМЕРВАТЕЛНА РОЛЕТКА

- Магнитна кука
- Гумирано покритие
- флуоресцентна лента
- Скала с големи числа

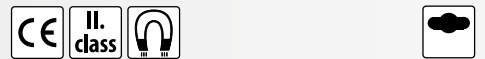

№	Характеристики	
11102	2 m · 16 mm	10
11103	3 m · 16 mm	10
11105	5 m · 19 mm	12
11106	5 m · 25 mm	12
11107	7,5 m · 25 mm	10
11110	10 m · 25 mm	6



FESTA

ИЗМЕРВАТЕЛНА РОЛЕТКА

- Скала с големи числа



№	Характеристики	
11226	2 m · 16 mm	10
11239	3 m · 19 mm	10
11259	5 m · 19 mm	12
11260	7,5 m · 25 mm	6



FESTA

ИЗМЕРВАТЕЛНА РОЛЕТКА

- Автоматичен стоп
- Гумирано покритие

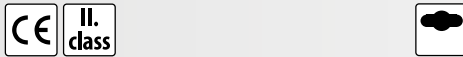

№	Характеристики	
11333	3 m · 16 mm	12
11335	5 m · 19 mm	12
11337	7,5 m · 25 mm	6
11338	10 m · 25 mm	6



FESTA

ИЗМЕРВАТЕЛНА РОЛЕТКА

- Компактен размер
- Найлоново покритие

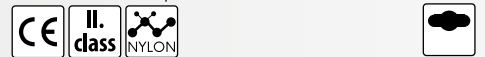

№	Характеристики	
11220	3 m · 16 mm	12
11221	5 m · 19 mm	12



Johnney®

ИЗМЕРВАТЕЛНА РОЛЕТКА

· Матирана скала

II. class



№	Характеристики	
11002	2 m · 13 mm	12
11003	3 m · 13 mm	12
11005	5 m · 13 mm	12
11006	5 m · 19 mm	12
11007	7,5 m · 19 mm	12
11008	10 m · 25 mm	12



ИЗМЕРВАТЕЛНА РОЛЕТКА

· Стопер
· Гумирано покритие



№	Характеристики	
11082	2 m · 16 mm	12
11083	3 m · 16 mm	12
11085	5 m · 19 mm	12



ИЗМЕРВАТЕЛНА РОЛЕТКА

· cm / инч
· Гумирано покритие



№	Характеристики	
11416	5 m · 19 mm	10



ИЗМЕРВАТЕЛНА РОЛЕТКА

· Стопер



№	Характеристики	
11200	2 m · 13 mm	24
11201	2 m · 16 mm	24
11202	2 m · 19 mm	24
11204	3 m · 13 mm	24
11205	3 m · 16 mm	24
11206	3 m · 19 mm	24
11207	5 m · 19 mm	12
11208	5 m · 25 mm	12
11209	7,5 m · 25 mm	12
11210	10 m · 25 mm	12

ИЗМЕРВАТЕЛНА РОЛЕТКА С ГРАВИРАНО ИМЕ, 3М • 16 ММ

CE II. class

№	Характеристики		№	Характеристики		№	Характеристики		№	Характеристики	
13500	JIRÍ	24	13509	MIROSLAV	24	13518	VÁCLAV	24	13527	MISTR	24
13501	PETR	24	13510	BIG BOSS	24	13519	JAKUB	24	13528	ONDŘEJ	24
13502	JOSEF	24	13511	ZDENĚK	24	13520	LUKÁŠ	24	13529	MAREK	24
13503	TOMÁŠ	24	13512	MICHAL	24	13521	2X MĚŘ	24	13530	STANISLAV	24
13504	JAN	24	13513	MILAN	24	13522	LADISLAV	24	13531	BOREC	24
13505	MARTIN	24	13514	KAREL	24	13523	DAVID	24	13532	TATÍNEK	24
13506	JAROSLAV	24	13515	VLADIMÍR	24	13524	ROMAN	24	13533	ANTONÍN	24
13507	FRANTIŠEK	24	13516	DĚDEČEK	24	13525	ŠIKULA	24	13534	ALEŠ	24
13508	PAVEL	24	13517	MŮJ METR	24	13526	RADEK	24			



10



FESTA

СТОМАНЕНА ЛЕНТА

· Халка

CE II. class



№	Характеристики	
12010	10 m · 10 mm	1
12020	20 m · 10 mm	1
12030	30 m · 10 mm	1
12050	50 m · 10 mm	6



FESTA

ЛЕНТА ОТ ФИБРОСТЪКЛО

· Халка

CE II. class



№	Характеристики	
12110	10 m · 13 mm	6
12120	20 m · 13 mm	1
12130	30 m · 13 mm	1
12150	50 m · 13 mm	1



FESTA

СТОМАНЕНА ЛЕНТА

· Халка + кука

CE II. class



№	Характеристики	
12220	20 m · 10 mm	6
12230	30 m · 10 mm	6
12250	50 m · 10 mm	6



FESTA

СТОМАНЕНА ЛЕНТА

· Халка



№	Характеристики	
12433	30 m · 12,5 mm	20
12435	50 m · 12,5 mm	10



ИЗМЕРВАТЕЛНО КОЛЕЛО

- Устойчиво, леко и компактно
- Брояч за измерване напред и назад
- Вградено осветление с 2 батерии клас AAA
- Калъф



№	Характеристики	
15989	max. 10 km	2



FESTA

ТЕЛЕСКОПИЧЕН ИЗМЕРВАТЕЛЕН ПРЪТ С НИВЕЛИР

· Калъф

№	Характеристики	
15983	0,7 - 3 m	10
15985	1,1 - 5 m	10
15988	1,6 - 8 m	5



САМОЗАЛЕПВАЩА СЕ ИЗМЕРВАТЕЛНА ЛЕНТА

II. class



№	Характеристики	
11311	1 m · 12,5 mm	30
11312	2 m · 12,5 mm	30
11313	3 m · 16 mm	30
11314	5 m · 19 mm	30



ИЗМЕРВАТЕЛНА РОЛЕТКА КЛЮЧОДЪРЖАТЕЛ

№	Характеристики	
11420	1 m · 6 mm Оранжев	24

FESTA

ИЗМЕРВАТЕЛНА РОЛЕТКА КЛЮЧОДЪРЖАТЕЛ

- Скала с големи числа
- Свойства на класическата измервателна лента

II. class

MOQ 12

№	Характеристики	
11410	2 m · 16 mm 6 цвята	12



ИЗМЕРВАТЕЛНА РОЛЕТКА КЛЮЧОДЪРЖАТЕЛ

№	Характеристики	
11444	1 m · 6 mm Бял	20



ИЗМЕРВАТЕЛНА РОЛЕТКА КЛЮЧОДЪРЖАТЕЛ

№	Характеристики	
11425	1 m · 6 mm	25



ЛИБЕЛА КЛЮЧОДЪРЖАТЕЛ

№	Характеристики	
11445		100

СГЪВАЕМ МЕТЪР



№	Характеристики	
13010	1 m · Бял	20
13020	2 m · Бял	10
13021	1 m · Жълт	20
13022	2 m · Жълт	10
13023	2 m · Бял и ЖЪЛТ	10

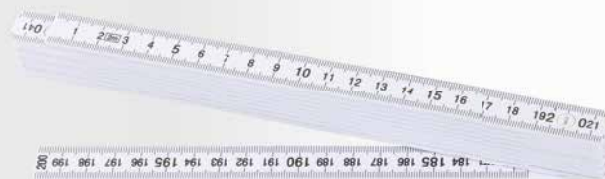
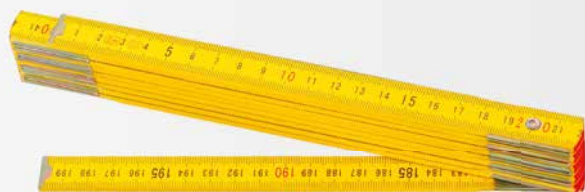
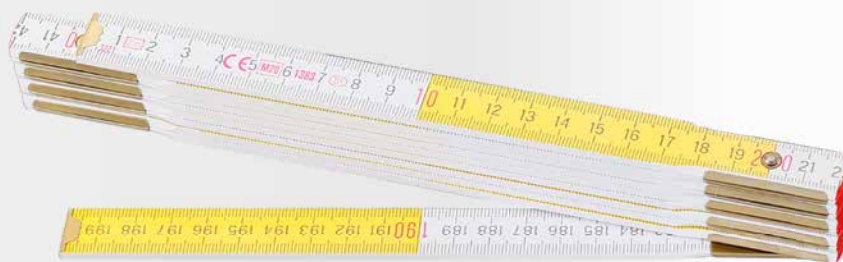

СГЪВАЕМ МЕТЪР



№	Характеристики	
13111	1 m · Жълт	10
13120	2 m · Жълт	5

СГЪВАЕМ МЕТЪР, ПЛАСТМАСОВ



№	Характеристики	
13211	1 m	1
13220	2 m	1



СГЪВАЕМ МЕТЪР С ГРАВИРАНО ИМЕ



№	Име	№	Име	№	Име	
13401	JIŘÍ	13426	DANIEL	13451	JANA	10
13402	JAN	13427	ANTONÍN	13452	EVA	
13403	PETR	13428	VOJTĚCH	13453	PETRA	
13404	JOSEF	13429	FILIP	13454	MAJKA	
13405	PAVEL	13430	ADAM	13455	HANA	
13406	MARTIN	13431	MILOSLAV	13456	ANNA	
13407	JAROSLAV	13432	MATEJ	13457	LENKA	
13408	TOMÁŠ	13433	ALEŠ	13458	KATKA	
13409	MIROSLAV	13434	JAROMÍR	13459	LUCIE	
13410	ZDENĚK	13435	LIBOR	13460	ALENA	
13411	FRANTIŠEK	13436	DOMINIK	13461	VERONIKA	
13412	VÁCLAV	13437	PATRIK	13462	MARTINA	
13413	MICHAL	13438	VLASTIMIL	13463	JITKA	
13414	MILAN	13439	JINDŘICH	13464	BIG BOSS	
13415	KAREL	13440	MILOŠ	13465	2 x MĚŘ	
13416	JAKUB	13441	JÁN	13466	TATÍNEK	
13417	LUKÁŠ	13442	PETER	13467	DĚDEČEK	
13418	DAVID	13443	ONDREJ	13468	ŠIKULA	
13419	VLADIMÍR	13444	JOZEF	13469	MISTR	
13420	LADISLAV	13445	PAVOL	13470	MACHR	
13421	ONDŘEJ	13446	L'UBOMÍR	13471	BOREC	
13422	ROMAN	13447	KAROL	13472	UŽ JE MŮJ	
13423	STANISLAV	13448	RADOSLAV	13473	MŮJ METR	
13424	MAREK	13449	VOJTĚCH			
13425	RADEK	13450	ZDENKO			

РЕКЛАМЕН СТЕЛАЖ ЗА СГЪВАЕМИ МЕТРИ

· Артикули за стелаж No. 13399

- 13401 · 15 бр.
- 13402 · 15 бр.
- 13403 · 15 бр.
- 13404 · 15 бр.
- 13405 · 15 бр.
- 13406 · 15 бр.
- 13412 · 15 бр.
- 13413 · 15 бр.
- 13414 · 15 бр.
- 13415 · 15 бр.
- 13416 · 15 бр.
- 13417 · 15 бр.
- 13418 · 15 бр.
- 13419 · 15 бр.
- 13420 · 15 бр.
- 13421 · 10 бр.
- 13422 · 10 бр.
- 13423 · 10 бр.
- 13424 · 10 бр.
- 13425 · 10 бр.
- 13426 · 10 бр.
- 13427 · 10 бр.
- 13428 · 10 бр.
- 13429 · 10 бр.
- 13430 · 10 бр.
- 13431 · 10 бр.
- 13432 · 10 бр.
- 13433 · 10 бр.
- 13434 · 10 бр.
- 13435 · 10 бр.
- 13436 · 10 бр.
- 13437 · 10 бр.
- 13438 · 10 бр.
- 13439 · 10 бр.
- 13440 · 10 бр.



№	Характеристики	
13399	Стелаж с артикули	1
13400	Стелаж без артикули	1



FESTA

ЕЛЕКТРОНЕН ШУБЛЕР С ДИГИТАЛЕН ДИСПЛ

INOX	№	Характеристики	10
	14007	150 0,01 mm	10
	14008	200 0,01 mm	10
	14009	300 0,01 mm	10



ЕЛЕКТРОНЕН ШУБЛЕР С ДИГИТАЛЕН ДИСПЛЕЙ

· Точност 0.2 mm, resolution 0.1 mm

№	Характеристики	10
14013	150 0,2 mm	10

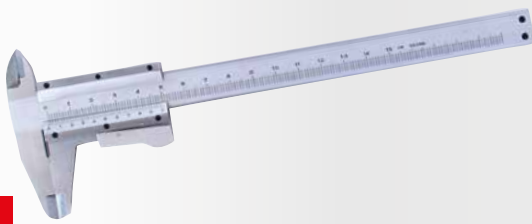

FESTA

ШУБЛЕР

INOX	№	Характеристики	10
	14004	150 0,02 mm	10

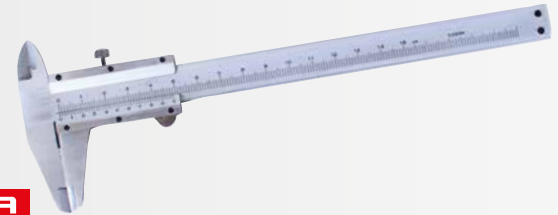

FESTA

ШУБЛЕР

INOX	№	Характеристики	10
	14001	150 0,02 mm	10
	14002	200 0,02 mm	10
	14003	300 0,02 mm	10



FESTA

МИКРОМЕТЪР

№	Характеристики	10
14040	0 - 0,25 0,01 mm	10
14045	25 - 50 0,01 mm	10



ШУБЛЕР, ПЛАСТМАСОВ

HOBBY

PLASTIC	№	Характеристики	50
	14006	150 mm	50



FESTA

ДЪЛБОКОМЕР

INOX	№	Характеристики	10
	14035	0 - 10mm 0,01 mm	10



ЛУФТОМЕР

· 20 листа

№	Характеристики	10
14080	0,05 - 1 mm	10



ПЕРГЕЛ

№	Характеристики	10
13285	200 mm	10



FESTA

ЧЕРТОЖНА ИГЛА

№	Характеристики	50
13281	150 mm	50



FESTA

ЧЕРТОЖНА ИГЛА

№	Характеристики	50
13282	200 mm	50

FESTA

ЛИНЕАЛ, АЛУМИНИЕВ

ALU



№	Характеристики	
14030	600 mm	6

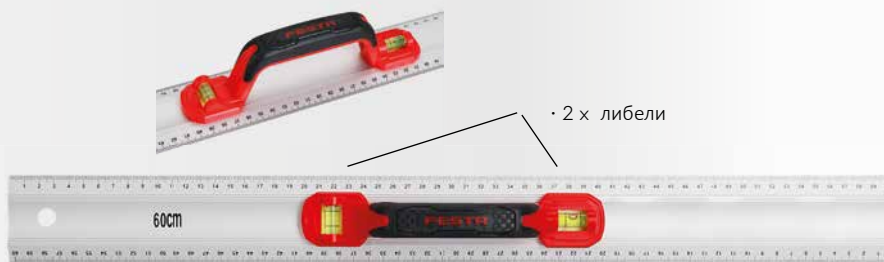

FESTA

ЛИНЕАЛ, АЛУМИНИЕВ

ALU



№	Характеристики	
14015	400 mm	48
14017	600 mm	50
14019	1000 mm	40



FESTA

ЛИНЕАЛ ОТ НЕРЪЖДАЕМА СТОМАНА

INOX



№	Характеристики	
14010	300 mm	10
14011	600 mm	10
14012	1000 mm	10

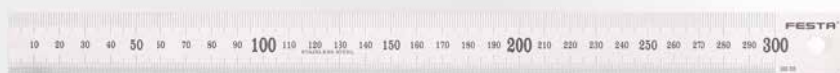

FESTA

ЪГЛОМЕР, НЕРЪЖДАЕМА СТОМАНА

· Калъф

№	Характеристики	
14060	0° - 180° · 150 x 200 mm	10
14070	0° - 180° · 300 x 500 mm	5

ЪГЛОМЕР

HOBBY

№	Характеристики	
14075	0° - 180° · 230 x 500 mm	30



МНОГОЪГЪЛНА ЛИНИЯ ЗА ТЕРАКОТ, ФАЯНС, ЛАМИНАТ И ДР.

No.	Specification
14077	



10



МНОГОЪГЪЛНА ЛИНИЯ



№	Характеристики	
14480	250 x 120 mm	1



ШАБЛОН ЗА КОПИРАНЕ НА ФИГУРИ



№	Характеристики	
14090	125 x 30 mm	1
14091	250 x 30 mm	1

FESTA

ПРАВ ЪГЪЛ 3D



№	Характеристики	
14418		10



FESTA

ПРАВ ЪГЪЛ БЕЗ ПЕТА



№	Характеристики	
14420	180 mm	10
14421	300 mm	10

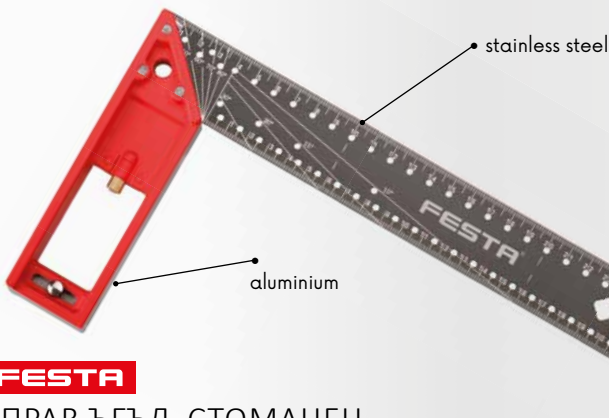

FESTA

ПРАВ ЪГЪЛ, СТОМАНЕН



No.	Specification	
14415	300 mm	6
14417	400 mm	6



FESTA

ПРАВ ЪГЪЛ

ALU



№	Характеристики	
14445	600 x 600 mm	1
14446	1200 x 1200 mm	1



FESTA

ПРАВ ЪГЪЛ

ALU



№	Характеристики	
14450	190 x 355 mm	6
14451	200 x 405 mm	6

FESTA

ПРАВ ЪГЪЛ, СТОМАНЕН



№	Характеристики	
14220	200 x 125 mm	10
14225	250 x 135 mm	10
14230	300 x 135 mm	10
14235	350 x 190 mm	10
14240	400 x 190 mm	10
14250	500 x 210 mm	10



FESTA

ПРАВ ЪГЪЛ



№	Характеристики	
14350	500 x 235 mm	10
14360	600 x 300 mm	10
14370	700 x 300 mm	10
14380	800 x 320 mm	10
14399	1000 x 360 mm	10

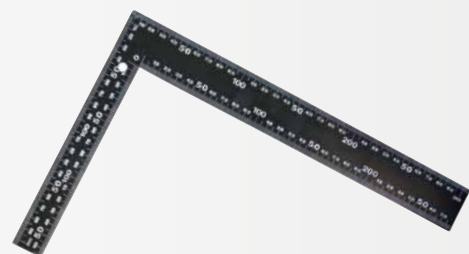

ПРАВ ЪГЪЛ

№	Характеристики	
14410	300 x 200 mm	50
14411	600 x 400 mm	36

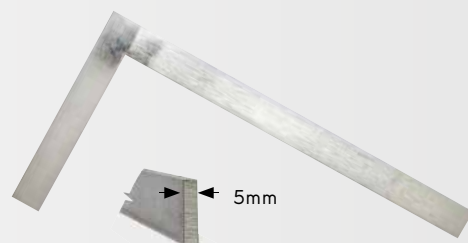

ПРАВ ЪГЪЛ

Zn	№	Характеристики	
	14471	150 x 100 mm	25
	14472	250 x 125 mm	25
	14473	400 x 200 mm	30
	14474	600 x 300 mm	25



ПРАВ ЪГЪЛ С ПЕТА

Zn	№	Характеристики	
	14490	100 x 50 mm	10
	14491	150 x 75 mm	10
	14492	250 x 125 mm	10
	14493	400 x 200 mm	10
	14494	600 x 300 mm	10



ПРАВ ЪГЪЛ

№	Характеристики	
14455	300 x 200 mm	50
14456	500 x 250 mm	50
14457	700 x 300 mm	40
14458	1000 x 450 mm	30



ПРАВ ЪГЪЛ БЕЗ ПЕТА

ALU HOBBY

№	Характеристики	
14425	250 x 130 mm	12
14430	300 x 130 mm	12
14435	350 x 156 mm	12
14440	400 x 156 mm	12



ПРАВ ЪГЪЛ, ДЪРВЕН



№	Характеристики	
14025	255 x 285 mm	1

MADE IN EUROPE

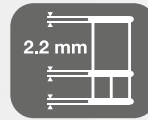
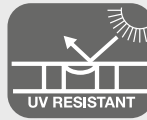
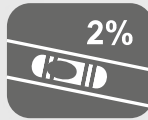
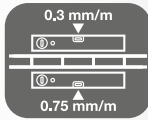

Всеки нивелир е електронно тестван и има контролен номер. Производителят е сертифициран по ISO 9001.



HORIZONT[®]
MASTER



HORIZONT[®]

НИВЕЛИР MASTER С 2 ЛИБЕЛИ

ALU

№	Характеристики	
15033	60 cm	10



HORIZONT[®]

НИВЕЛИР MASTER С 3 ЛИБЕЛИ

ALU

№	Характеристики	
15034	80 cm	10
15035	100 cm	10



HORIZONT[®]

НИВЕЛИР MASTER С 3 ЛИБЕЛИ И ДВЕ РЪКОХВАТКИ

ALU

№	Характеристики	
15036	120 cm	10
15037	150 cm	10
15039	200 cm	10

HORIZONT®

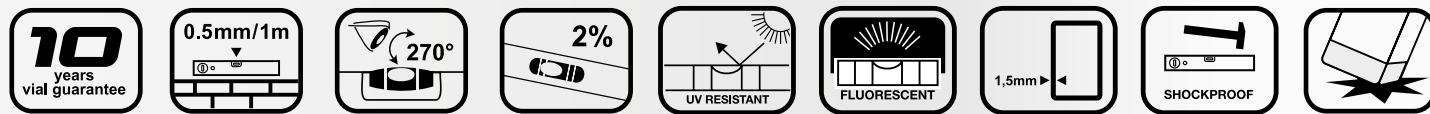

Всеки нивелир е електронно тестван и има контролен номер. Производителят е сертифициран по ISO 9001.

HORIZONT® НИВЕЛИР С 2 ЛИБЕЛИ



№	Характеристики	
15003	30 cm	30
15004	40 cm	30
15005	50 cm	30
15006	60 cm	30
15008	80 cm	30
15010	100 cm	30
15012	120 cm	10
15015	150 cm	10
15018	180 cm	10
15020	200 cm	10



HORIZONT® НИВЕЛИР С 3 ЛИБЕЛИ



№	Характеристики	
15103	30 cm	30
15104	40 cm	30
15105	50 cm	30
15106	60 cm	30
15108	80 cm	30
15110	100 cm	30
15112	120 cm	10
15115	150 cm	10
15118	180 cm	10
15120	200 cm	10



HORIZONT® НИВЕЛИР С 2 ЛИБЕЛИ И МАГНИТ



№	Характеристики	
15204	40 cm	30
15205	50 cm	30
15206	60 cm	30
15208	80 cm	30
15210	100 cm	30
15212	120 cm	10
15215	150 cm	10
15218	180 cm	10
15220	200 cm	10



HORIZONT® НИВЕЛИР ЗА ИЗМЕРВАНЕ НА НАКЛОН И ЪГЛИ С 4 ЛИБЕЛИ



№	Характеристики	
15230	80 cm	10

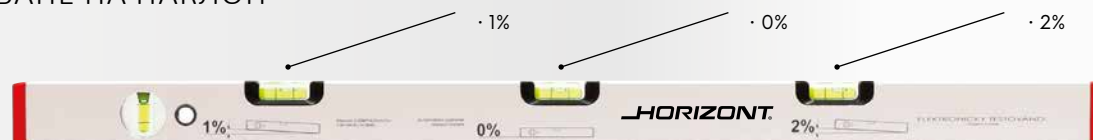

HORIZONTНИВЕЛИР ЗА ИЗМЕРВАНЕ НА НАКЛОН
И ЪГЛИ С 1 ЛИБЕЛА

№	Характеристики	
15235	60 cm	1

**HORIZONT**

МАСТАР

ALU

№	Характеристики	
15310	100 cm	10
15315	150 cm	10
15318	180 cm	10
15320	200 cm	10
15325	250 cm	10
15330	300 cm	10
15335	350 cm	10
15340	400 cm	10

**HORIZONT**

МАСТАР НИВЕЛИР С 1 ЛИБЕЛА

ALU

№	Характеристики	
15415	150 cm	10
15418	180 cm	10
15420	200 cm	10
15425	250 cm	10
15430	300 cm	10

**HORIZONT**

МАСТАР НИВЕЛИР С 2 ЛИБЕЛИ

ALU

№	Характеристики	
15510	100 cm	10
15515	150 cm	10
15518	180 cm	10
15520	200 cm	10
15525	250 cm	10
15530	300 cm	10
15535	350 cm	10
15540	400 cm	5

**HORIZONT**

МАСТАР НИВЕЛИР С 2 РЪКОХВАТКИ, БЕЗ ЛИБЕЛИ

ALU

№	Характеристики	
15615	150 cm	10
15620	200 cm	10
15625	250 cm	10
15630	300 cm	10



HORIZONT

МАСТАР НИВЕЛИР С 2 РЪКОХВАТКИ И 2 ЛИБЕЛИ

ALU

№	Характеристики	
15710	100 cm	10
15715	150 cm	10
15720	200 cm	10
15725	250 cm	10
15730	300 cm	10
15735	350 cm	10
15740	400 cm	5



HORIZONT

ТРАПЕЦОВИДЕН ПРОФИЛ

ТРАПЕЦОВИДЕН ПРОФИЛ

- Трапецовиден профил за фина шпакловка на мазилка
- Подходящ за мазилки и фасади
- Подходящ за тънкослойни покрития

ALU

№	Характеристики	
15810	100 cm	10
15812	120 cm	10
15815	150 cm	10
15818	180 cm	10
15820	200 cm	10
15825	250 cm	10
15830	300 cm	10



HORIZONT

h-ПРОФИЛ

h-ПРОФИЛ

- h-профил за фина шпакловка на мазилка
- Подходящ за мазилки и фасади
- Подходящ за гипсови и циментови мазилки

ALU

№	Характеристики	
15850	100 cm	10
15853	150 cm	10
15855	180 cm	10
15860	200 cm	10
15870	250 cm	10
15880	300 cm	10

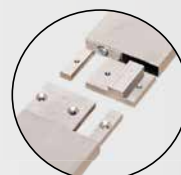

NEW

HORIZONT

СЪЕДИНИТЕЛ
ЗА МАСТАР
НИВЕЛИР

№

Характеристики



15301

1



HORIZONT

МАСТАР НИВЕЛИР С 1
ЛИБЕЛА РЕГУЛИРУЕМА



№	Характеристики	
15893	65 - 100 cm	1
15894	95 - 150 cm	1
15895	145 - 235 cm	1

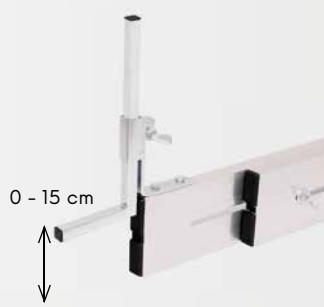

0 - 15 cm

HORIZONT

ПРАВ ЪГЪЛ

ALU

№	Характеристики	
14485	800 x 1200 mm	1
14486	1000 x 1500 mm	1



HORIZONT.
СТЕЛАЖ ЗА
НИВЕЛИРИ HORIZONT

· Артикули на стелаж 15998

- 15003 · 5 бр.
- 15004 · 5 бр.
- 15005 · 5 бр.
- 15006 · 5 бр.
- 15008 · 5 бр.
- 15010 · 5 бр.
- 15012 · 5 бр.
- 15015 · 3 бр.
- 15018 · 3 бр.
- 15020 · 3 бр.
- 15108 · 3 бр.
- 15206 · 3 бр.
- 15210 · 3 бр.

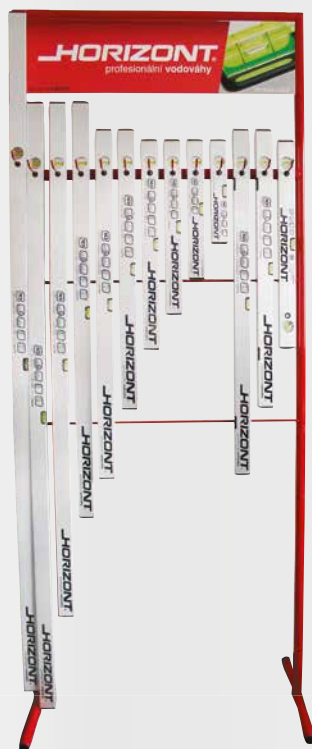

HORIZONT.
СТЕЛАЖ ЗА
НИВЕЛИРИ И ПРОФИЛИ

· Артикули на стелаж 15996

- 15004 · 5 бр.
- 15005 · 5 бр.
- 15006 · 5 бр.
- 15008 · 5 бр.
- 15010 · 5 бр.
- 15012 · 5 бр.
- 15015 · 5 бр.
- 15018 · 5 бр.
- 15020 · 5 бр.
- 15315 · 2 бр.
- 15320 · 2 бр.
- 15325 · 3 бр.
- 15515 · 2 бр.
- 15520 · 2 бр.
- 15525 · 3 бр.



№	Характеристики	
15999	85 x 210 x 50 cm	1
15998	85 x 210 x 50 cm с артикули	1

№	Характеристики	
15997	55 x 75 x 40 cm	1
15996	55 x 75 x 40 cm с артикули	1

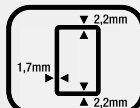
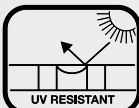

FESTA
НИВЕЛИР NIVELA
С 3 ЛИБЕЛИ



№	Характеристики	
15754	400 mm	1
15756	600 mm	1
15758	800 mm	1
15760	1000 mm	1
15762	1200 mm	1
15768	1800 mm	1
15770	2000 mm	1



NEW

NIVELA

НИВЕЛИР NIVELA С 2 ЛИБЕЛИ

- Точност 0,5 mm | 1 m (в базова позиция)
- UV устойчиви либели
- Удароустойчиви гумени тапи в краищата
- Дебелина на профила 1,2 mm



№	Характеристики	
15904	40 cm	30
15906	60 cm	30
15908	80 cm	30
15910	100 cm	30
15912	120 cm	20
15915	150 cm	10
15920	200 cm	20



НИВЕЛИР NIVELA С 3 ЛИБЕЛИ

ALU HOBBY

№	Характеристики	
15954	40 cm	60
15956	60 cm	60
15958	80 cm	60
15960	100 cm	30
15962	120 cm	30
15965	150 cm	30
15970	200 cm	30



НИВЕЛИР С 3 ЛИВЕЛИ И МАГНИТ, ПЛАСТМАСОВ



№	Характеристики	
15980	230 mm	1

НИВЕЛИР ЗА КАНАП



№	Характеристики	
15981		1

НИВЕЛИР ЗА КОЛОНИ

- 3 либели, магнити, затягащ колан



№	Характеристики	
26028		12



ВОДЕН НИВЕЛИР



№	Характеристики	
15992	Съклени тръби и маркуч 10 m	1
15993	Съклени тръби и маркуч 10 m	1
15990	Съклени тръби	50
15991	Пластмасови тръби	50



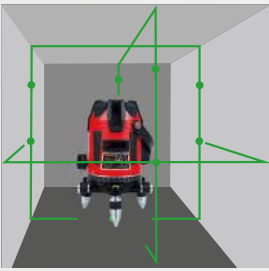
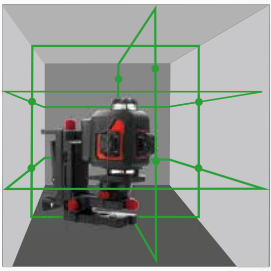

FESTA

LASER ALL LINE GREEN 4 X 360 °

- 2x хоризонтална равнина + 2x вертикална равнина (зелен лъч)
- диапазон на самонивелиране $\pm 4^\circ$
- точност: 0,2 mm/m
- на закрито 30 m, с лазерен приемник до 50 m
- импулсен режим – препоръчан аксесоар приемник 26209
- Доставка се с: транспортна кутия, дистанционно управление, лазерна мишена, Li-ion батерия 5200 mAh, професионална стойка, мини статив, зарядно

FESTA

ЗЕЛЕН КРЪСТ ЛАЗЕР

- 1x хоризонтална равнина + 4x вертикална равнина (зелен лъч) + 1x точка
- диапазон на самонивелиране $\pm 3^\circ$
- точност: 0,2 mm/m
- на закрито 20 m, с лазерен приемник до 50 m
- импулсен режим – препоръчан аксесоар приемник 26209
- Доставка се с: транспортна кутия, лазерна мишена, Li-ion батерия 5200 mAh, професионална стойка, мини статив, зарядно

$\pm 4^\circ$	max. 50 m	± 0.2 mm/m	II. class	515 nm
1/4"	5/8"	IP54	Li-ion 3.7V 5.2Ah	



№ 26205

Характеристики

1

$\pm 3^\circ$	max. 50 m	± 0.2 mm/m	II. class	515 nm
5/8"	IP54	Li-ion 3.7V 5.2Ah		



№ 26203

Характеристики

1





FESTA

LASER ALL LINE GREEN 3 X 360 °

- 1x хоризонтална равнина + 2x вертикална равнина (зелен лъч)
- диапазон на самонивелиране $\pm 4^\circ$
- точност 0,2 mm/m
- на закрито: 30 м, на открито с детектор 50 м
- импулсен режим – препоръчан аксесоар приемник 26209
- Включително: калъф за носене, 4xAA алкални батерии, лазерна мишена, очила, 2600 mAh литиево-йонна батерия, професионална скоба, зарядно устройство, поставка за литиево-йонна батерия

$\pm 4^\circ$	INDOOR 30m OUTDOOR 50m	± 0.2 mm/m	II. class	515 nm
IP 54	5/8"	1/4"	4x AA	Li-Ion 7.4V 2.6Ah



№ Характеристики

26204

1



FESTA

ЗЕЛЕН КРЪСТ ЛАЗЕР

- 1x хоризонтална равнина + 1x вертикална равнина (зелен лъч)
- диапазон на самонивелиране $\pm 3^\circ$
- точност 0,2 mm/m
- на закрито: 20 м, на открито с детектор 50 м
- импулсен режим – препоръчан аксесоар приемник 26209
- Включително: калъф за носене, 2xAA алкални батерии, скоба

$\pm 3^\circ$	INDOOR 20m OUTDOOR 50m	± 0.2 mm/m	II. class	515 nm
IP 54	1/4"	2x AA		

№ Характеристики

26201

1

FESTA

ДАЛЕКОМЕР

- обхват на измерване 0,05- 50 m
- точност на измерване ± 2 mm, мерна единица mm/in/ft
- непрекъснато измерване, измерване на площ, измерване на обем, измерване на крака на триъгълник, LCD FSTN, събиране/изваждане, макс./мин. измерване уредба, максимално съхранение 100 единици, подсветка, лазерен клас 630-670 nm клас 2
- работна температура 0- 40°C
- размери 112 x 50 x 25 mm, тегло 90 g
- Включително: калъф за носене, 2xAAA алкални батерии

max 50m	± 2 mm	m in ft	630 670 nm
IP 54	2x AAA		

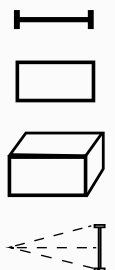

№ Характеристики

26211

1



1/4" + 5/8"



60 - 150 cm

FESTA

ЛАЗЕРЕН ПРИЕМНИК

- за използване с импулсни лазерни устройства за разширяване на обхвата след 50 m
- включено: 9 V батерия, скоба
- за 26201, 26203, 26204, 26205

max 50m	±1.5mm / 10m	5 kHz	IP54	1x 9V
---------	--------------	-------	------	-------



СТАТИВ

ALU



№	Характеристики	1
26209		1

№	Характеристики	1
26219	60 - 150 cm 1/4" + 5/8"	1

FESTA

ЦИФРОВ ИНКЛИНОМЕТЪР

- 0° - 360°
- Точност ±0,1°
- Отклонение 0,1°
- Функция за автоматично изключване
- HOLD функция за съхранение на измерената стойност
- Дисплей с подсветка
- Размери 60x60x25 mm
- Батерия 1xAAA



· Магнитна долна страна

LCD DISPLAY	1x AAA	0-50°C	82g
-------------	--------	--------	-----



№	Характеристики	1
26218		1



FESTA

ТРАНСПОРТИР С ЦИФРОВ ДИСПЛЕЙ

200 mm	mm / inch	LCD DISPLAY	0°-360°
0.05°	+/- 0.2°	MANUAL LOCKING	1x CR2032 3V



FESTA

ТРАНСПОРТИР С ЦИФРОВ ДИСПЛЕЙ

- LCD дисплей
- Обхват на измерване 0° - 225°
- Отклонение 0,1°
- Точност ± 0,3

ALU	044.8° LCD DISPLAY	3V LITHIUM
-----	--------------------	------------



№	Характеристики	1
26217	200 mm	1

№	Характеристики	1
26216	300 mm	1

FESTA

MULTIMETR

- Измерване на постоянно напрежение: 200 mV- 300 V
- Измерване на AC напрежение: 200 mV- 300 V
- Измерване на постоянен ток: 2000 μ A- 10 A
- измерване на съпротивление: 200 Ω - 2 M Ω
- проверка на батерията: 1,5 V, 9 V
- индикация за изтощена батерия
- защита от претоварване

- IEC61010
- CATIII 300 V
- GS сертификат
- захранване: 9 V батерия (6F22)
- размери: 70x128x28 mm
- тегло: 137 g (с батерия)
- аксесоари: тестови кабели



№ Характеристики

18429



1



FESTA

ТЕСТЕР ЗА НАПРЕЖЕНИЕ

- AC/DC- 6V, 12V, 24V, 50V, 120V, 230V, 400V
- водоустойчивост IP54
- определяне на полярността
- CAT III 400V



№ Характеристики

18428



1



Laserliner®

LUXTEST-MASTER

Професионален светломер

- Измерване на интензитета на светлината в работни помещения, офиси, обществени сгради и индустриални сгради
- Чувствителен фотодиод с корекция на косинус за широк ъгъл на измерване на светлината
- Относителна измервателна функция за референция и сравнително измерване
- Функция за регистриране на бързи промени в нивата на осветеност
- Функция за автоматично запаметяване на стойност
- Автоматична и ръчна промяна на обхвата
- Функция за зануляване
- Измервани променливи: Lux (lm/m²), foot candle (lm/ft²)
- Дисплей, показващ максимални и минимални стойности
- 1/4" трипод конектор.



№ Характеристики

	Обхват на измерване	20 Lux . . . 200000 Lux
26520	Точност	± 3% (референтна стойност 2854 K)
	Косинус ъглово отклонение	± 2% (30°), ± 6% (60°)



1

Характеристики

Окомплектовка Батерия, куфар

Laserliner®

AIRFLOWTEST-MASTER

Професионален анемометър- за измерване на въздушния поток, обемния поток и скоростта на вятъра

- Интегриран сензор за измерване температурата на околната среда, относителната влажност и определяне точката на оросяване
- USB интерфейс за съхранение на данните от измервания
- Компютърен софтуер за пренос на данни в реално време
- Голяма работна перка: 65 mm.
- Дисплей, показващ максимални и минимални стойности
- 1/4" трипод конектор
- Осветен дисплей с постоянно видими стойности за температура на околната среда и точка на оросяване.



№ Характеристики

	Дебит:	0.80...30 m s ± 2%
26521	Темп. на околната среда	-10...60°C ± 1.5°C
	Относителна влажност:	20%...80% ± 3%
	Обемен поток:	0...99990 CMM



ЗАПИС НА КОМПЮТЪР

Характеристики

Окомплектовка Софтуер, USB кабел, батерия, куфар



1



FESTA

ДЪРВОДЕЛСКИ МОЛИВИ С ТВЪРДОСТ HB



MOQ 12

№	Характеристики	MOQ
13270	HB · 180 mm	96
13271	HB · 180 mm · к-т 3 бр.	32
13265	HB · 250 mm	96



FESTA

ДЪРВОДЕЛСКИ МОЛИВИ С ТВЪРДОСТ HB, КУТИЯ



MOQ 50

№	Характеристики	MOQ
13269	HB · 180 mm	50
13266	HB · 250 mm	50



FESTA

ДЪРВОДЕЛСКИ МОЛИВИ С ТВЪРДОСТ HB



MOQ 12

№	Характеристики	MOQ
13272	HB · 250 mm	96
13264	HB · 250 mm · без печат	96



FESTA

ДЪРВОДЕЛСКИ МОЛИВИ С ТВЪРДОСТ HB



MOQ 50

№	Характеристики	MOQ
13268	250 mm	50



FESTA

ТРИЪГЪЛЕН МОЛИВ HB



MOQ 12

№	Характеристики	MOQ
13278	250 mm	96



FESTA

МОЛИВИ ЗА КАМЪК 6H

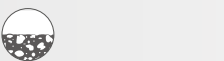

MOQ 12

№	Характеристики	MOQ
13275	6H · 250 mm	96



FESTA

МОЛИВИ ЗА СЪКЛО И КЕРАМИКА



MOQ 12

№	Характеристики	MOQ
13273	175 mm Червен, за стъкло и керамика	144



FESTA

ЦВЕТНИ ХИМИЧЕСКИ МОЛИВИ

№	Характеристики	MOQ
13274	175 mm, червен- син	96

MOQ 12



МОЛИВ С ТВЪРДОСТ НВ



MOQ
12

№	Характеристики	
13280	180 mm	96



МОЛИВ

MOQ
12

№	Характеристики	
13276	175 mm	144



Шкурка

ОСТРИЛКА



№	Характеристики	
13261		12



NEW

FESTA

СТОМАНЕН МОЛИВ С КЛИПС И ТВЪРДОСТ НВ

· Резервен графит 13263, 13267



№	Характеристики	
13288		20



FESTA

СТОМАНЕН МОЛИВ С КЛИПС И ТВЪРДОСТ НВ

· Резервен графит 13263, 13267



№	Характеристики	
13262	150 mm	20



FESTA

МОЛИВ СЪС СМЕНЯЕМ ГРАФИТ С ТВЪРДОСТ НВ



№	Характеристики	
13279	Молив + графит НВ	24
13284	Резервен графит 5 бр.	20

FESTA

ЦВЕТНИ МОЛИВИ

· за 13262, 13288



№	Характеристики	
13267	2x žltá 2x červená 2x modrá	1

FESTA

ЧЕРНИ МОЛИВИ НВ

· за 13262, 13288



№	Характеристики	
13263	6x černá	20





ПЕРМАНЕНТЕН МАРКЕР



№	Характеристики	
13200	○ Бял	1
13201	● Черни	1
13202	● Червен	1



NEW

ПЕРМАНЕНТЕН МАРКЕР



- Изключително здрав връх
- За маркиране дори върху мазни и мокри повърхности



№	Характеристики	
13216	Червени	12
13217	Черни	12
13218	Син	12
13219	Зелени	12



ПЕРМАНЕНТЕН МАРКЕР



- 2 типа връх
- За маркиране дори върху мазни и мокри повърхности



№	Характеристики	
13227	Бял	ALU 40
13222	Бял	PVC 12
13228	Червени	ALU 40
13229	Черни	ALU 40
13230	Син	ALU 12
13231	Зелени	ALU 12



ПЕРМАНЕНТЕН МАРКЕР



№	Характеристики	
13214	Бял	12
13225	Червени	12
13226	Черни	12
13223	Син	12
13224	Зелени	12



ПЕРМАНЕНТЕН МАРКЕР



№	Характеристики	
13235	Червени	12
13236	Черни	12
13237	Син	12
13238	Зелени	12



FESTA

ПЕРМАНЕНТЕН МАРКЕР



№	Характеристики	
13246	● Crni	1
13247	● Червен	1
13248	○ Бял	1



ПЕРМАНЕНТЕН МАРКЕР - 2 ТИПА ВРЪХ

MOQ 12



№ No.	Характеристики	
13206	○ Бял	12



ПЕРМАНЕНТЕН МАРКЕР - 2 ТИПА ВРЪХ

MOQ 12



№	Характеристики	
13212	Crni	12



ПЕРМАНЕНТЕН МАРКЕР - 2 ТИПА ВРЪХ

MOQ 12



№	Характеристики	
13207	● Червен	12
13208	● Син	12



МИНИ ПЕРМАНЕНТЕН МАРКЕР



· Дължина на маркера 9 cm

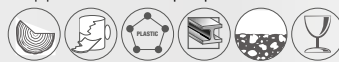

MOQ 72

№	Характеристики	
13205	● ● ● ● ●	72



FESTA

МАРКИРАЩА КРЕДА К-Т 5 БРОЯ

· Ø 13 x 110 mm

5x



№	Характеристики	Кол.
13240	5 цвята	20
13241	Червени	20
13242	Черни	20

№	Характеристики	Кол.
13243	Жълти	20
13244	Зелени	20
13245	Бели	20



ДЪРЖАЧ ЗА СПРЕЙ КЪМ КОЛИЧКА

· За спрейове Trackmarker и Fluo



№	Характеристики	Кол.
13296		1



ВОСЪЧЕН ПАСТЕЛ К-Т 6 БРОЯ

6x



№	Характеристики	Кол.
13277		88



ТЕБЕШИР

12x



№	Характеристики	Кол.
13260	12 x 12 x 80 mm	46



ДЪРЖАЧ ЗА ПИСТОЛЕТ ЗА СПРЕЙ

· За спрейове Trackmarker и Fluo



№	Характеристики	Кол.
13295		1



ФЛУОРЕСЦЕНТЕН СПРЕЙ TRACKMARKER 500 ML

- Висока видимост благодарение на флуоресцентен пигмент
- Предпазна капачка
- Бързоизсъхващ- до 10 мин.
- Трайност- 3 месеца
- За употреба върху бетон, асфалт, трева, чакъл, пясък, камък, дърво



№	Характеристики	
13250	Жълт	12
13251	Червен	12
13252	Оранжев	12
13253	Зелен	12
13254	Розов	12
13249	Син	12



ФЛУОРЕСЦЕНТЕН СПРЕЙ MARK 6M FLUO 500 ML

- Висока видимост благодарение на флуоресцентен пигмент
- Предпазна капачка
- Бързоизсъхващ- до 10 мин.
- Трайност- 6 месеца
- За употреба върху бетон, асфалт, трева, чакъл, пясък, камък, дърво



№	Характеристики	
13360	Жълт	12
13361	Червен	12
13362	Оранжев	12
13363	Зелен	12
13364	Розов	12
13365	Бял	12



ФЛУОРЕСЦЕНТЕН СПРЕЙ FLUO 500 ML

- Висока видимост благодарение на флуоресцентен пигмент
- Предпазна капачка
- Бързоизсъхващ- до 10 мин.
- Трайност- 12 месеца
- За употреба върху бетон, асфалт, трева, чакъл, пясък, камък, дърво



№	Характеристики	
13350	Жълт	12
13351	Червен	12
13352	Оранжев	12
13353	Зелен	12
13354	Розов	12
13355	Бял	12



ФЛУОРЕСЦЕНТЕН СПРЕЙ IDEAL 500 ML

- Висока видимост благодарение на флуоресцентен пигмент
- Предпазна капачка
- Бързоизсъхващ- до 10 мин.
- Трайност- 12 месеца
- За употреба върху бетон, асфалт, трева, чакъл, пясък, камък, дърво



№	Характеристики	
13255	Жълт	12
13256	Червен	12
13257	Оранжев	12
13258	Зелен	12
13259	Розов	12



KDS®

Японски макетни ножове KDS

- Висока ергономичност на дръжката
- Дълъг експлоатационен живот
- Изработени от най-качествени материали
- Ниско съпротивление за лесно рязане.

KDS®
 МАКЕТЕН НОЖ

№	Характеристики	Кол-во
16002	LC405 18 mm Зелен	25
16011	LB10 Резервни остриета	10

KDS®
 МАКЕТЕН НОЖ

№	Характеристики	Кол-во
16003	G11 18 mm + 2 остриета	10
16012	GB10 Резервни остриета	10

KDS®
 МАКЕТЕН НОЖ

№	Характеристики	Кол-во
16019	L19 18 mm + 2 остриета	10
16011	LB10 Резервни остриета	10
16012	GB10 Резервни остриета	10

KDS®
 МАКЕТЕН НОЖ

№	Характеристики	Кол-во
16004	H11 25 mm	10
16013	HB10 Резервни остриета	10

KDS®
 МАКЕТЕН НОЖ

№	Характеристики	Кол-во
16005	S14 9 mm + 2 остриета	10
16010	SB10 Резервни остриета	10

KDS®
 НОЖ ТИП СКАЛПЕЛ

№	Характеристики	Кол-во
16006	D12 + 16 остриета	10

KDS®
 РЕЗЕРВНИ ОСТРИЕТА

№	Характеристики	Кол-во
16010	SB10 9 0,38 mm	13 сегмента
16011	LB10 18 0,5 mm	15 сегмента
16012	GB10 18 0,6 mm	15 сегмента
16013	HB10 25 0,7 mm	7 сегмента

KDS®
 РЕЗЕРВНИ ОСТРИЕТА

- Специална сплав
- Двойно шлифовани
- По-дълъг експлоатационен живот
- Ниско съпротивление на рязане
- Лесна употреба



№	Характеристики	Кол-во
16016	LB10B 18 0,5 mm	8 сегмента
16017	HB10B 25 0,7 mm	7 сегмента

KDS®
 СТЕЛАЖ ЗА МАКЕТНИ НОЖОВЕ

№	Характеристики	Кол-во
16999	Рекламен стелаж	1
16998	Стелаж с артикули	1



- Артикули на стелаж 16998 : 16001 · 5бр.
- 16003 · 5бр.
- 16004 · 3бр.
- 16005 · 3бр.
- 16006 · 2бр.
- 16008 · 3бр.
- 16010 · 4бр.
- 16012 · 4бр.
- 16013 · 16бр.
- 16016 · 4бр.
- 16018 · 4бр.
- 16019 · 4бр.
- 16020 · 4бр.

· Снимката е илюстративна



FESTA



система за счупване на острието



FESTA
INDUSTRY

МАКЕТЕН НОЖ

· Гумирана дръжка против хлъзгане



№	Характеристики	
16099	18 mm	12

FESTA[®]



FESTA[®]

**МАКЕТЕН НОЖ
С КЕРАМИЧНО ОСТРИЕ**

- 3 пъти по-остро в сравнение със стоманено острие
- 10 пъти по-дълъг експлоатационен живот
- Огнеупорни, непроводими, немагнитни



№	Характеристики	
16131	18 mm	10
16066	Резервни остриета 18 mm, 5 бр.	10

FESTA[®]

МАКЕТЕН НОЖ



№	Характеристики	
16110	L11 18 mm + 1 острие	12

FESTA[®]

МАКЕТЕН НОЖ



№	Характеристики	
16100	L12 18 mm + 1 острие	12

FESTA[®]

МАКЕТЕН НОЖ



№	Характеристики	
16105	L17 18 mm + 1 острие	12

FESTA[®]

МАКЕТЕН НОЖ



№	Характеристики	
16125	L4 9 mm	24
16120	L8 18 mm	24

FESTA[®]

МАКЕТЕН НОЖ



№	Характеристики	
16115	L10 9 mm	24



FESTA

МАКЕТЕН НОЖ, АЛУМИНИЙ

ALU

№	Характеристики	
16150	18 mm	MOQ 24
16151	18 mm	Без лого FESTA 20



FESTA

МАКЕТЕН НОЖ, АЛУМИНИЙ

ALU

№	Характеристики	
16136	18 mm	12



FESTA

МАКЕТЕН НОЖ, АЛУМИНИЙ

ALU

№	Характеристики	
16137	25 mm	12



FESTA

МАКЕТЕН НОЖ, АЛУМИНИЙ

· Гумирана дръжка против хлъзгане

+4 ALU

№	Характеристики	
16090	18 mm	12



FESTA

МАКЕТЕН НОЖ

· Гумирана дръжка против хлъзгане

+4 ALU

№	Характеристики	
16091	25 mm	6



FESTA

МАКЕТЕН НОЖ, АЛУМИНИЙ

· Гумирана дръжка против хлъзгане

ALU

№	Характеристики	
16145	L25 18 mm	12



FESTA

МАКЕТЕН НОЖ, АЛУМИНИЙ

· Гумирана дръжка против хлъзгане

ALU

№	Характеристики	
16144	L24 18 mm	12



МАКЕТЕН НОЖ, АЛУМИНИЙ

ALU

№	Характеристики	
16143	18 mm	12



МАКЕТЕН НОЖ, АЛУМИНИЙ

ALU

№	Характеристики	
16142	18 mm	12



МАКЕТЕН НОЖ

ALU

№	Характеристики	
16025	18 mm	12



FESTA

МАКЕТЕН НОЖ

ALU

№	Характеристики	
16029	18 mm	25



FESTA

МАКЕТЕН НОЖ

· Гумирана дръжка против хлъзгане

ALU

№	Характеристики	
16146	18 mm	12



FESTA

МАКЕТЕН НОЖ

· Гумирана дръжка против хлъзгане



№	Характеристики	Пакет
16147	25 mm	12



FESTA

МАКЕТЕН НОЖ

· Гумирана дръжка против хлъзгане



№	Характеристики	Пакет
16130	L18 18 mm + 5 остриетак	12



FESTA

МАКЕТЕН НОЖ

· Гумирана дръжка против хлъзгане



№	Характеристики	Пакет
16135	L20 25 mm + 5 остриетак	6



FESTA

МАКЕТЕН НОЖ

· Гумирана дръжка против хлъзгане



№	Характеристики	Пакет
16140	L22 18 mm	12



FESTA

МАКЕТЕН НОЖ

· Гумирана дръжка против хлъзгане



№	Характеристики	Пакет
16034	25 mm	12



FESTA

МАКЕТЕН НОЖ



№	Характеристики	Пакет
16085	9 mm	24

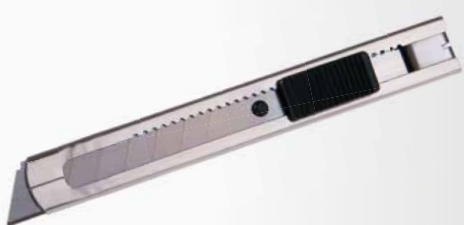

FESTA

МАКЕТЕН НОЖ



№	Характеристики	Пакет
16086	18 mm	24



ПРЕДПАЗЕН НОЖ

· самоубиращо се острие

№	Характеристики	Пакет
16044		20



ПРЕДПАЗЕН НОЖ

· самоубиращо се острие

№	Характеристики	Пакет
16057	135 mm	12



FESTA

ПРЕДПАЗЕН НОЖ



№	Характеристики	Пакет
16058		6
16074	Резервни остриета 10 бр.	1

16074



NEW



FESTA

СГЪВАЕМ НОЖ

+2 SK4



№	Характеристики	
16039		6
16087	Резервни остриета	1



FESTA

МАКЕТЕН НОЖ

+5 ALU



№	Характеристики	
16037	+ 5 остриета	6



FESTA

СГЪВАЕМ НОЖ

+5 ALU



№	Характеристики	
16023	СГЪВАЕМ НОЖ + 5 остриета	12
16071	Резервни остриета 10 бр.	10



FESTA

КОМПЛЕКТ НОЖОВЕ

ALU

№	Характеристики	
16095	25 остриета	1

КОМПЛЕКТ НОЖОВЕ

22x



№	Характеристики	
16282		24



КОМПЛЕКТ НОЖОВЕ

13x



№	Характеристики	
16281		10



FESTA

МАКЕТЕН НОЖ

· Гумирана дръжка против хлъзгане

ALU +2



№	Характеристики	
16035	+ 2 остриета	12



FESTA

НОЖ ТИП ДЕЛФИН

ALU +3



№	Характеристики	
16033	NP 110 + 3 остриета	5





НОЖ ТИП ДЕЛФИН

ALU		
№	Характеристики	
16032	NP 109	48

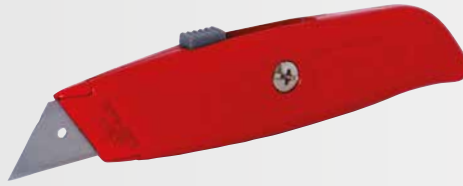

МАКЕТЕН НОЖ, РЕГУЛИРУЕМ

ALU		
№	Характеристики	
16031	NS 107 B	24



МАКЕТЕН НОЖ

ALU		
№	Характеристики	
16030	NS 107	24



МАКЕТЕН НОЖ

ALU		
№	Характеристики	
16046	18 mm	12



МАКЕТЕН НОЖ

№	Характеристики	
16028	S 201 18 mm	24



МАКЕТЕН НОЖ

№	Характеристики	
16026	P 205 18 mm	30



МАКЕТЕН НОЖ

HOBBY		
№	Характеристики	
16021	P 201 9 mm	60



МАКЕТЕН НОЖ

HOBBY		
№	Характеристики	
16024	P 204 18 mm	60



КОМПЛЕКТ
МАКЕТНИ НОЖОВЕ

№	Характеристики	
16141	18 mm	24

MOQ
24

· Гумирана дръжка против хлъзгане

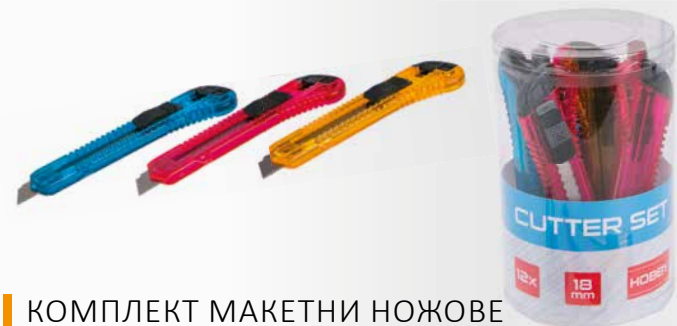

КОМПЛЕКТ МАКЕТНИ НОЖОВЕ

HOBBY	12x		
№	Характеристики		
16053	9 mm	12	
16055	18 mm	12	



КОМПЛЕКТ МАКЕТНИ НОЖОВЕ

HOBBY	3x		
№	Характеристики		
16043		24	



НОЖ ЗА КИЛИМИ И ПОДОВИ НАСТИЛКИ

· За килими и подови настилки



№	Характеристики	
16036	45 mm	12



МАКЕТЕН НОЖ ТИП "ОРЛОВ НОКЪТ"

· За килими и подови настилки



№	Характеристики	
16041		12



50 mm

СТЪРГАЛКА ЗА СЪКЛО, ДЪЛГА

ALU



№	Характеристики	
16059	50 mm	10
16082	Резервно острие	1



100 mm

СТЪРГАЛКА ЗА СЪКЛО, ДЪЛГА

· за използване с 18 mm остриета за макетни ножове

ALU



№	Характеристики	
16054	100 mm	1



100 mm

СТЪРГАЛКА ЗА СЪКЛО, ДЪЛГА



№	Характеристики	
16052	48 cm Дължина на ножа	6
16070	острие	25



38 mm

FESTA

СТЪРГАЛКА С ГУМЕНА ДРЪЖКА

· Гумирана дръжка против хлъзгане



№	Характеристики	
16049		12
16069	Резервни остриета	1



60 mm

СТЪРГАЛКА ЗА СЪКЛО



№	Характеристики	
16051		24



55 mm

СТЪРГАЛКА ЗА СЪКЛО



№	Характеристики	
16050		24



КОМПЛЕКТ ЗА ПОСТАВЯНЕ И ОТСТРАНЯВАНЕ НА СИЛИКОН

3x



№	Характеристики	
16042		12

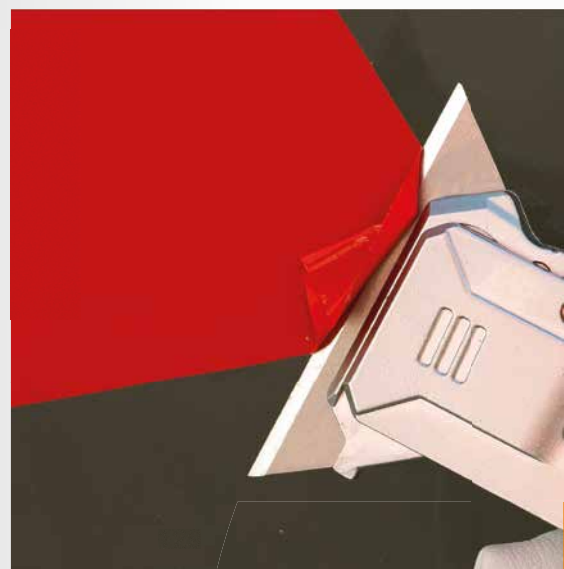



FESTA

РЕЗЕРВНО ОСТРИЕ

- 7 сегмента
- 3x пъти по-дълъг експлоатационен живот
- двойно шлифовани
- ниско съпротивление на рязане

SK2 10x



№	Характеристики	
16064	25 0,7 mm	20

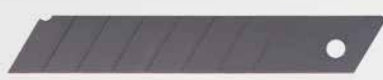

FESTA

РЕЗЕРВНО ОСТРИЕ

- 8 сегмента
- 3x пъти по-дълъг експлоатационен живот
- двойно шлифовани
- ниско съпротивление на рязане

SK2 10x



№	Характеристики	
16062	18 0,7 mm	10



FESTA

РЕЗЕРВНО ОСТРИЕ

- 15 сегмента
- 3x пъти по-дълъг експлоатационен живот
- двойно шлифовани
- mali otvor rezanja | ниско съпротивление на рязане

SK2 10x



№	Характеристики	
16063	18 0,7 mm	10



FESTA

РЕЗЕРВНО КЕРАМИЧНО ОСТРИЕ

- 8 сегмента
- 3 пъти по-остро в сравнение със стоманено острие
- 10x пъти по-дълъг експлоатационен живот
- Огнеупорни, непроводими, немагнитни

5x



№	Характеристики	
16066	18 0,6 mm	10



РЕЗЕРВНО ОСТРИЕ

- 8 сегмента
- Двойно шлифовани

10x



№	Характеристики	
16078	18 0,5 mm	25



РЕЗЕРВНО ОСТРИЕ

- 8 сегмента
- Двойно шлифовани

10x



№	Характеристики	
16077	18 0,6 mm	25



РЕЗЕРВНО ОСТРИЕ

- 7 сегмента

10x



№	Характеристики	
16068	25 0,6 mm	20



РЕЗЕРВНО ОСТРИЕ

- 8 сегмента

10x



№	Характеристики	
16065	18 0,5 mm	60



РЕЗЕРВНО ОСТРИЕ

- 15 сегмента

10x



№	Характеристики	
16081	18 0,5 mm	60



РЕЗЕРВНО ОСТРИЕ

- 4 сегмента

10x



№	Характеристики	
16067	18 0,5 mm	10



РЕЗЕРВНО ОСТРИЕ

- 7 сегмента

10x



№	Характеристики	
16061	9 0,4 mm	60



РЕЗЕРВНО ОСТРИЕ

- 13 сегмента

10x



№	Характеристики	
16060	9 0,45 mm	10



FESTA

РЕЗЕРВНО ОСТРИЕ

10x



№	Характеристики	
16072	R 004	10



FESTA

РЕЗЕРВНО ОСТРИЕ

10x



№	Характеристики	
16075	R 003	10



РЕЗЕРВНО ОСТРИЕ

10x

№	Характеристики	
16071	R 001	60

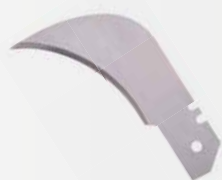

РЕЗЕРВНО ОСТРИЕ

5x

№	Характеристики	
16083	18 mm	50



РЕЗЕРВНО ОСТРИЕ

10x

№	Характеристики	
16073	R 002	60



РЕЗЕРВНО ОСТРИЕ

5x

№	Характеристики	
16084	18 mm	50

FESTA

РЕЗЕРВНО ОСТРИЕ

· За 16058

10x

№	Характеристики	
16074		1



РЕЗЕРВНО ОСТРИЕ

· За 34315

№	Характеристики	
34316		1

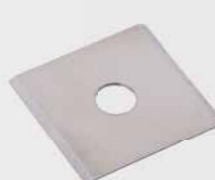

РЕЗЕРВНО ОСТРИЕ

· За 16052

№	Характеристики	
16070	100 mm	25



FESTA

НОЖ ЗА МИНЕРАЛНА ВАТА

№	Характеристики	
16198	44,5 33 cm	12



FESTA

НОЖ ЗА ИЗОЛАЦИЯ

· Нож за минерална вата, полистирен

№	Характеристики	
16199	48 35 cm	10



FESTA

МАЧЕТЕ

TEFLON

№	Характеристики	
45069	490 mm	6



FESTA

МАЧЕТЕ С ТРИОН

TEFLON

№	Характеристики	
44950	490 mm	4



МАЧЕТЕ ОТ НЕРЪЖДАЕМА СТОМАНА

INOX

№	Характеристики	
45083	430 mm	12
45084	600 mm	6



МАЧЕТЕ

· С дръжка от ясен

№	Характеристики	
45081	510 mm	36
45082	710 mm	36



FESTA

ЛОВДЖИЙСКИ НОЖ

- Пластасова дръжка
- Тефлоново покритие на острието
- Кания с предпазител и заключване



INOX	TEFLON	NYLON	№	Характеристики	
			16234	21 10 cm	10



FESTA

ЛОВДЖИЙСКИ НОЖ



INOX	TEFLON	№	Характеристики	
		16229	23 10 cm	12



FESTA

МУЛТИФУНКЦИОНАЛЕН НОЖ

- Плътно острие



MOQ 12

INOX	№	Характеристики	
	16231	20 8 cm	12



ТЕХНИЧЕСКИ НОЖ

- Плътно острие

INOX	№	Характеристики	
	16230	21 10 cm	12



FESTA

НОЖ ЗА КИЛИМИ И ПОДОВИ НАСТИЛКИ

№	Характеристики	
16225	20 8,5 cm	12



FESTA

ЕЛЕКТРИЧАРСКИ НОЖ ЗА ОГОЛВАНЕ НА КАБЕЛИ

- Плътно острие

INOX	№	Характеристики	
	16212	15 3,2 cm	12



FESTA

НОЖ ЗА ОГОЛВАНЕ НА КАБЕЛИ

№	Характеристики	
16201	Ø 8 - 27 mm	10



FESTA

ЕЛЕКТРИЧАРСКИ НОЖ ЗА ОГОЛВАНЕ НА КАБЕЛИ

INOX	№	Характеристики	
	16211	20 8,5 cm	10



FESTA

ЕЛЕКТРИЧАРСКИ НОЖ ЗА ОГОЛВАНЕ НА КАБЕЛИ

INOX	№	Характеристики	
	16210	20,5 9 cm	10



FESTA

НОЖ ЗА ПРИСАЖДАНЕ



INOX	№	Характеристики	24
	16219	19 11 cm	



FESTA

НОЖ ЗА ПРИСАЖДАНЕ



INOX	№	Характеристики	24
	16218	18,5 10,5 cm	



FESTA

НОЖ ЗА ПРИСАЖДАНЕ



INOX	№	Характеристики	24
	16220	18,5 11 cm	



FESTA

ДЖОБЕН НОЖ



INOX	№	Характеристики	24
	16235	17,5 8,5 cm	



FESTA

ДЖОБЕН НОЖ



INOX	№	Характеристики	24
	16221	21 12 cm	



FESTA

ДЖОБЕН НОЖ



INOX	№	Характеристики	24
	16236	22,5 10 cm	



FESTA

ДЖОБЕН НОЖ



INOX	№	Характеристики	1
	16209	14,5 5,5 cm	



FESTA

ДЖОБЕН НОЖ



INOX	№	Характеристики	24
	16222	20 12 cm	



FESTA

ДЖОБЕН НОЖ



INOX	ALU	№	Характеристики	24
		16223	18,5 10,5 cm	



FESTA

ШВЕЙЦАРСКО НОЖЧЕ

· 5 инструмента

INOX	№	Характеристики	24
	16228	27 10,5 cm	



FESTA

ШВЕЙЦАРСКО НОЖЧЕ

· 10 инструмента

INOX	№	Характеристики	24
	16226	17,5 7 cm	



ШВЕЙЦАРСКО НОЖЧЕ

· 7 инструмента

INOX	№	Характеристики	24
	16224	17,5 7 cm	



ШВЕЙЦАРСКО НОЖЧЕ, ЛОВДЖИЙСКО

· 3 инструмента

INOX	№	Характеристики	24
	16227	20,5 10 cm	



FESTA

МНОГОФУНКЦИОНАЛНИ КЛЕЩИ

· 9 инструмента

· Калъф

CrV	№	Характеристики	12
	16232		



NEW

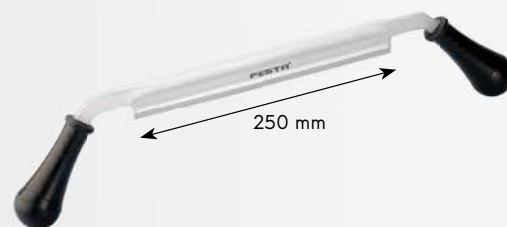

FESTA

РУКАН ЗА ДЪРВО

CrV	№	Характеристики	1
	24132	250/490 mm	



ДЪРВОДЕЛСКО РЕНДЕ



№	Характеристики	1
19510	220 x 65 x 130 mm, нож 48 mm	



ДЪРВОДЕЛСКО РЕНДЕ



№	Характеристики	1
19515	200 x 55 x 130 mm, нож 39 mm	



ДЪРВОДЕЛСКО РЕНДЕ



№	Характеристики	1
19520	225 x 27 x 155 mm, нож 27 mm	



FESTA

ДЛЕТО

CrV

№	Характеристики	
19490	6 mm 290 mm	6
19491	8 mm 290 mm	6
19492	10 mm 290 mm	6
19493	12 mm 290 mm	6
19494	14 mm 290 mm	6
19495	16 mm 290 mm	6



3 mm

FESTA

ДЛЕТО

INOX

№	Характеристики	
16231	20 80 mm	12



MOQ 12



FESTA

КОМПЛЕКТ ДЛЕТА С ТОЧИЛО

CrV

5x

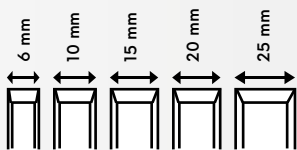

№	Характеристики	
19451		10



FESTA

КОМПЛЕКТ ДЛЕТА

CrV

4x

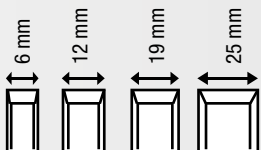

№	Характеристики	
19457		10



КОМПЛЕКТ ДЛЕТА

4x

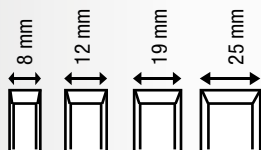

№	Характеристики	
19455		30

FESTA



FESTA

КОМПЛЕКТ СТРУГАРСКИ ДЛЕТА

CrV

8x

№	Характеристики	
19458	365 125mm	1



КОМПЛЕКТ ДЛЕТА

4x

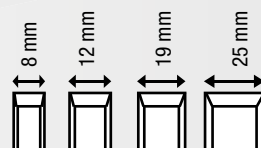

№	Характеристики	
19450		20



КОМ. ДЛЕТА ЗА РЕЗБОВАНЕ

12x CrV

№	Характеристики	
19459		5

FESTA

ТОЧИЛО ЗА НОЖИЦИ И НОЖОВЕ 16 В 1



	30° Anvil	
	45° Anvil	
	50° Anvil	
	23° Bypass	
	35° Bypass	
	65° Bypass	
	Deburr Tool	



№ 45073 Размери



ДВУСТРАННО ТОЧИЛО

№ 45370 Характеристики 250 x 33 x 18 mm 20

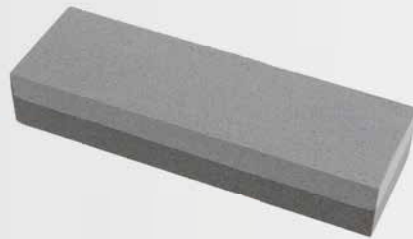

ДВУПЛАСТОВО ТОЧИЛО

№ 45045 Характеристики 150 x 50 x 30 mm 1



ТОЧИЛО ЗА КОСА

№ 45046 Характеристики 205 x 15 mm 100



ТОЧИЛО

№ 16991 Характеристики 20



ТОЧИЛО

№ 16990 Характеристики Ø 50 mm 1



ТОЧИЛО

№ 45048 Характеристики 20



ТОЧИЛО

№ 45068 Характеристики 10





FESTA
POWER X TOOLS

**ПОЯЛНИК ЗА СПОЙКА
НА PVC И PPR ТРЪБИ**

- Напряжение 230 V / 50 Hz
- Консумация на енергия 750 / 1500 W
- Температура 0-300 C°
- Удължителни Ø 20,25,32,40,50,63 mm
- Тегло 1,6 kg



· Окомплектовка: измервателна лента, нивелир, отвертка, естограм, ножици за тръби



№
17182

1

FESTA
POWER X TOOLS

**ПОЯЛНИК ЗА СПОЙКА
НА PVC И PPR ТРЪБИ**

- Напряжение 230 V / 50 Hz
- Консумация на енергия 800 / 1000 W
- Температура 0-300 C°
- Удължителни Ø 16, 20, 25, 32 mm
- Тегло 1 kg



· Окомплектовка: куфар, 2 шестограма, винтове, стелаж



№
17183

1

FESTA

НОЖИЦИ ЗА PVC ТРЪБИ

max.
Ø 42 mm



№	Характеристики	10
17027		10
16315	Резервни остриета	1



**РЕЗЕРВНО ОСТРИЕ
ЗА НОЖИЦИ**

· За 17027

№	Характеристики	1
16315		1



FESTA



FESTA

**НОЖИЦИ
ЗА PVC ТРЪБИ**

max.
Ø 32 mm



№	Характеристики	12
17037		12



**НОЖИЦИ
ЗА PVC ТРЪБИ**

max.
Ø 42 mm



№	Характеристики	6
17026		6



NEW

FESTA

НОЖИЦИ ЗА ТРЪБИ

INOX ALU

ALU Cu PVC



№	Характеристики	10
16305	Ø 22 mm	10
16306	Ø 15 mm	10
16307 NEW	Ø 28 mm	10



NEW

FESTA

НОЖИЦИ ЗА ТРЪБИ

PLASTIC INOX

PVC

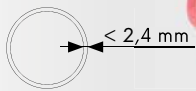

№	Характеристики	10
16308	Ø 20 - 50 mm	10

FESTA

НОЖИЦИ ЗА ТРЪБИ

Ø 15 mm
Ø 22 mm
Ø 28 mm

3x INOX ALU

ALU Cu PVC



№	Характеристики	1
16309		1



FESTA

НОЖИЦИ ЗА ТРЪБИ



3-22 mm



№	Характеристики	10
16301		10
16311	Резервно острие	1

FESTA

НОЖИЦИ ЗА ТРЪБИ, ТЪНКОВЕННИ



6-64 mm



№	Характеристики	6
16304		6
16312	Резервно острие	1

НОЖИЦИ ЗА ТРЪБИ, ТЪНКОВЕННИ



3-32 mm



№	Характеристики	10
16303		10
16311	Резервно острие	1

НОЖИЦИ ЗА ТРЪБИ



3-32 mm



№	Характеристики	10
16300		10
16310	Резервно острие	1

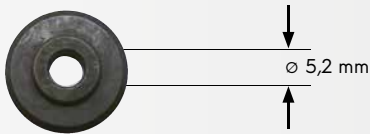

РЕЗЕРВЕН ДИСК ЗА РЯЗАНЕ НА PVC ТРЪБИ



№	Характеристики	1
16310	Ø 17,5 mm x 6 m за 16300	1
16311	Ø 18,0 mm x 4,5 mm за 16303, 16301	1
16312	Ø 27,5 mm x 6 mm за 16304	1



FESTA

НОЖИЦИ ЗА ТРЪБИ И ПРОФИЛИ

Цокли, профили, тръби

5x Ø 17 mm Ø 20 mm Ø 27 mm



№	Характеристики	8
17050	60 250 mm	8

NEW

FESTA

ИНСТРУМЕНТ ЗА ПОЧИСТВАНЕ КРАИЩА НА ТРЪБИ



6-38 mm

ALU



№	Характеристики	1
16319	Ø 6 - 38 mm	1

FESTA

ИНСТРУМЕНТ ЗА ПОЧИСТВАНЕ КРАИЩА НА ТРЪБИ



1/4"



№	Характеристики	1
16321		1

ИНСТРУМЕНТ ЗА ПОЧИСТВАНЕ КРАИЩА НА ТРЪБИ



6-32 mm



№	Характеристики	1
16320		1

FESTA

ИНСТРУМЕНТ ЗА ПОЧИСТВАНЕ И ФРЕЗОВАНЕ



HSS Ø 25 mm 90°



№	Характеристики	10
20360		10

ИНСТРУМЕНТ ЗА ПОЧИСТВАНЕ КРАИЩА НА ТРЪБИ



№	Характеристики	1
20361		1



ОТВЕРТКА, ПРАВА

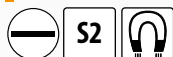

№	Характеристики	
18113	3 x 75 mm	12
18114	4 x 100mm	12
18115	5,5 x 125 mm	12
18116	6,5 x 150 mm	12
18118	8 x 175 mm	6
18120	10 x 200 mm	6



ОТВЕРТКА, ПРАВА, КЪСА

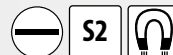

№	Характеристики	
18124	5,5 x 38 mm	12
18125	6,5 x 38 mm	12



ОТВЕРТКА, КРЪСТАТА, ТИП PHILIPS

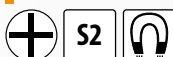

№	Характеристики	
18210	0 x 75 mm	12
18211	1 x 75 mm	12
18212	2 x 100 mm	12



ОТВЕРТКА, КРЪСТАТА, ТИП PHILIPS, КЪСА

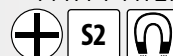

№	Характеристики	
18215	1 x 38 mm	12
18216	2 x 38 mm	12



ОТВЕРТКА, ЗВЕЗДОВИДНА, ТИП POZIDRIVE

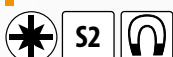

№	Характеристики	
18310	0 x 75 mm	12
18311	1 x 100 mm	12
18312	2 x 100 mm	12
18313	3 x 150 mm	6



ОТВЕРТКА, ЗВЕЗДОВИДНА, ТИП POZIDRIVE, КЪСА

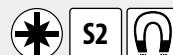

№	Характеристики	
18321	1 x 38 mm	12
18322	2 x 38 mm	12



ОТВЕРТКА, ТИП TORX



№	Характеристики	
18350	T6	12
18351	T7	12
18352	T8	12
18353	T9	12
18354	T10	12
18355	T15	12
18356	T20	12
18357	T25	12
18358	T27	12
18359	T30	12
18360	T40	6



РЕВЕРСИВНА ОТВЕРТКА С 7 БИТА

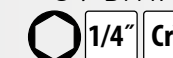

- ⊖ S 5 · 6 mm
- ⊕ PH 1 · 2 · 3
- ⊛ T 15 · 20



№	Характеристики	
18425	1/4" CVT	10

NEW



КОМПЛЕКТ ОТВЕРТКИ С БИТОВЕ

114x S2



№	Характеристики	
18434		1

- отвертка за битове
- отвертка за прецизни битове
- отвертка
 - ⊖ 3x75, 5x75, 5x100, 6x100, 6x150, 8x150
 - ⊕ 0x75, 1x75, 1x100, 2x100, 2x150
 - ⊛ T10x75, T15x75
 - ⊖ VDE 2.5x75mm, 4.0x100mm
 - ⊖ фазомер
 - ⊖ 2.5x40, 3.0x40mm
 - ⊕ 00x40mm, 0x40mm,
 - ⊛ T6x40mm, T7x40mm
- шестограм
 - 1/16", 5/64", 3/32", 1/8", 5/32", 3/16", 7/32", 1/4"
 - 1.5, 2.0, 2.5, 3.0, 4.0, 5.0, 5.5, 6.0mm
- вложки
 - 6mm, 7mm, 8mm, 9mm, 10mm, 11mm
- битове
 - ⊖ SL 3mm, 4mm, 4.5mm, 5mm, 5.5mm, 6mm, 7mm, 8mm
 - ⊕ PH0, PH0, PH1, PH1, PH2, PH2, PH3, PH3
 - ⊛ P20, P20, P21, P21, P22, P22, P23, P23,
 - ⊛ T6, T8, T10, T15, T20, T25, T27, T30, T35, T40
 - H1.5, H2.5, H3.0, H3.5, H4.0, H4.5, H5.0, H5.5, H6, H8
 - ⊖ S0, S1, S2, S3
 - ⊖ SL 1.5mm, 2.0mm, 2.5mm, 3.0mm, 4.0mm
 - ⊕ PH000, PH00, PH0, PH1
 - ⊛ T4, T5, T6, T7, T8, T9, T10, T15, T20
 - H0.7, H0.9
- прецизни битове



ОТВЕРТКИ - ПРАВИ, КРЪСТАТИ

⊖ S 3x75 · 5x100 · 6,5x150mm

⊕ PH 0 · 1 · 2 · 3



7x



№ Характеристики

18402

6



ОТВЕРТКИ - ПРАВИ, КРЪСТАТИ

⊖ S 3x75 · 5x100 · 6x150mm

⊕ PH 0 · 1 · 2



6x



№ Характеристики

18403

6



КОМПЛЕКТ ОТВЕРТКИ - ПРАВИ, КРЪСТАТИ, ЗВЕЗДОВИДНИ

⊖ S 6,5x38 · 5,5x75 · 6,5x100 · 8x150 mm
2,5x50 · 3x50 mm

⊕ PH 2x38 · 1x75 · 2x100 · 3x150 mm
0x50 · 00x50 mm

⊛ T 5x50 · 6x50 · 7x50 · 8x50 · 9x50 · 10x50 mm



18x



№ Характеристики

18424

6



ОТВЕРТКИ - ПРАВИ, ЗВЕЗДОВИДНИ

⊖ S 3x60 · 6x100 · 6x125mm

⊛ PZ 0 · 1 · 2



6x



№ Характеристики

18404

6



ОТВЕРТКИ, ТИП TORX

⊛ T 10 · 15 · 20 · 25 · 30



5x



№ Характеристики

18340

6



КОМПЛЕКТ ОТВЕРТКИ - ПРАВИ, КРЪСТАТИ, ЗВЕЗДОВИДНИ, ЗА БИТОВЕ

⊖ S 3 x 75 · 4x100 · 5,5x125 · 6,5 x 150mm

⊕ PH 1 · 100 · 2 x 100mm

⊖ adapter 1/4"

Битов

⊖ S 4 · 5 · 6 · 7

⊕ PH 1 · 2 · 3

⊛ PZ 1 · 2 · 3

⊛ T 10 · 15 · 20 · 25 · 30

⊛ H 2 · 3 · 4 · 5 · 6



27x



№ Характеристики

18422

27 бр.

6



FESTA
INDUSTRY

ЕЛЕКТРИЧАРСКА ОТВЕРТКА, ПРАВА, VDE



№	Характеристики		
18088	3 x 75 mm	S2	12
18089	4 x 100 mm	CrV	12
18090	5,5 x 125 mm	CrV	12
18091	6,5 x 150 mm	CrV	12
18092	8 x 175 mm	CrV	12



FESTA
INDUSTRY

ЕЛЕКТРИЧАРСКА ОТВЕРТКА, КРЪСТАТА, ТИП PHILIPS, VDE



№	Характеристики		
18080	PH 0 x 60 mm	S2	12
18081	PH 1 x 80 mm	CrV	12
18082	PH 2 x 100 mm	CrV	12
18083	PH 3 x 150 mm	CrV	12



FESTA
INDUSTRY

КОМПЛЕКТ ЕЛЕКТРИЧАРСКИ ОТВЕРТКИ

⊖ S 4x100 · 5,5x125 mm · фазомер 0 - 250 V

⊕ PH 0x60 · 1x80 · 2x100 mm



№	Характеристики	
18413		6

FESTA
INDUSTRY

ЕЛЕКТРИЧАРСКА ОТВЕРТКА, ЗВЕЗДОВИДНА, ТИП POZIDRIVE, VDE



№	Характеристики		
18084	PZ 0 x 60 mm	S2	12
18085	PZ 1 x 80 mm	CrV	12
18086	PZ 2 x 100 mm	CrV	12
18087	PZ 3 x 150 mm	CrV	12



FESTA

УДАРНА ОТВЕРТКА, ПРАВА, УСИЛЕНА



№	Характеристики	
18062	5,5 x 100 mm	12
18063	7 x 125 mm	6
18064	8 x 150 mm	8
18065	10 x 175 mm	6
18066	10 x 200 mm	6
18067	10 x 250 mm	6



FESTA

КОМПЛЕКТ ЕЛЕКТРИЧАРСКИ ОТВЕРТКИ

⊖ S 4x100 · 5,5x125 · 6,5x150 mm · фазомер 0 - 250 V

⊕ PH 0x75 · 1x100 · 2x100 mm



№	Характеристики	
18410		40

FESTA

УДАРНА ОТВЕРТКА, КРЪСТАТА, ТИП PHILIPS, УСИЛЕНА



№	Характеристики	
18070	PH 1 x 80 mm	8
18071	PH 2 x 100 mm	12
18072	PH 3 x 150 mm	6



FESTA

УДАРНА ОТВЕРТКА, ЗВЕЗДОВИДНА, ТИП POZIDRIVE, УСИЛЕНА



№	Характеристики	
18075	PZ 1 x 80 mm	12
18076	PZ 2 x 100 mm	12
18077	PZ 3 x 150 mm	6



FESTA

УДАРНА ОТВЕРТКА С БИТ

⊖ S 7 x 35 · 8 x 35 · 8 x 70 mm

⊕ PH 2 x 35 · 3 x 35 · 3 x 70 mm

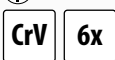

№	Характеристики	
18411		1



FESTA

КОМПЛЕКТ УДАРНИ ОТВЕРТКИ ПРАВИ, КРЪСТАТИ, УСИЛЕНИ

⊖ S 5 · 6 · 8 mm

⊕ PH 1 · 2 · 3



№	Характеристики	
18423		10





FESTA

КОМПЛЕКТ ОТВЕРТКИ С БИТОВЕ

⊖ S 3x75 · 4x75 · 6x100 · 8x150 mm

⊕ PH 1x75 · 2x100 mm

○ Adapter 1/4"

Битове: ⊖ S 4 · 5 · 6 · 7 mm

⊕ PH 1 · 2 · 3

⊗ PZ 1 · 2 · 3

⊛ T 10 · 15 · 20

⊙ ↔ ⊠ adapter



№	Характеристики	
18418		10



FESTA

КОМПЛЕКТ ОТВЕРТКИ

⊖ S 3x60 · 4x75 · 6x100 · 6x125 mm

⊕ PH 0x60 · 1x75 · 2x100 mm



№	Характеристики	
18400		10



FESTA

КОМПЛЕКТ ОТВЕРТКИ

⊖ S 3x60 · 6x100 · 6x125 mm

⊕ PH 1x75 · 2x100 mm



№	Характеристики	
18401		50

FESTA

ОТВЕРТКА, ПРАВА



№	Характеристики	
18101	3 x 75 mm	10
18102	4 x 100 mm	10
18103	5,5 x 100 mm	10
18104	5,5 x 125 mm	10
18105	6,5 x 100 mm	10
18106	6,5 x 125 mm	10
18107	8 x 160 mm	10
18108	10 x 160 mm	10

FESTA

ОТВЕРТКА, КРЪСТАТА, ТИП PHILIPS



№	Характеристики	
18201	0 x 75 mm	10
18202	1 x 75 mm	10
18203	2 x 100 mm	10
18204	3 x 150 mm	10

FESTA

ОТВЕРТКА, ЗВЕЗДОВИДНА, ТИП POZIDRIVE

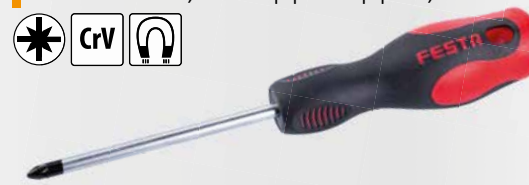

№	Характеристики	
18301	0 x 75 mm	10
18302	1 x 75 mm	10
18303	2 x 100 mm	10
18304	3 x 150 mm	10

FESTA

РЕВЕРСИВНА ОТВЕРТКА



№	Характеристики	
18110		12



FESTA

ОТВЕРТКА

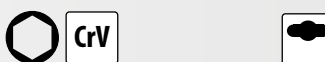

№	Характеристики	
18455	6 mm	12
18456	7 mm	12
18460	13 mm	12



FESTA

ОТВЕРТКА ЗА БИТОВЕ, ГЪВКАВА

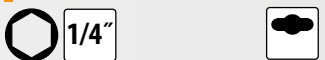

№	Характеристики	
18451		12



FESTA

ОТВЕРТКА ЗА БИТОВЕ, ГЪВКАВА

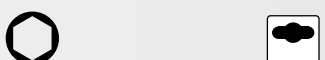

№	Характеристики	
18450	7 mm	6





РЕВЕРСИВНА ОТВЕРТКА

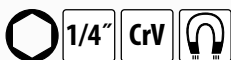

№ 18433 Характеристики

6



ШЕСТОГРАМ ОТВЕРТКА

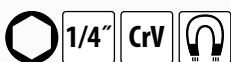

№ 18608 Характеристики

6



ШЕСТОГРАМ ОТВЕРТКА С 20 БИТА

- ⊖ S 3 · 4 · 5 · 6 · 8 mm
- ⊕ PH 0 · 1 · 2 · 3
- adapter + 5 · 6 · 7 · 8 · 9 · 10 · 11 · 12 · 13 mm



№ 18420 Характеристики

5



КОМПЛЕКТ ОТВЕРТКА С БИТОВЕ И АДАПТЕР

- ⊖ S 1.5 · 2 · 2.5 · 3 · 3.5 mm
- ⊕ PH 000 · 00 · 0 · 1
- ⊛ PZ 0 · 1
- ⊛ T 5 · 6 · 7 · 8 · 9 · 10 · 15 · 20
- ⊛ H 0.9 · 1.3 · 2.0 · 2.5 · 3.0 · 4.0

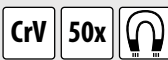

№ 18431 Характеристики



6



ГЕДОРЕ КОМПЛЕКТ С ВЛОЖКИ И БИТОВЕ

- 1/4" ⊖ ↔ ⊕ 1/4"
- ⊖ S 3 · 4 · 5 · 6 · 7 · 5 L
 - ⊕ PH 1 · 2 · 3 · 1L · 2 L
 - ⊛ PZ 1 · 2 · 3 · 1L · 2 L
 - ⊛ H 2 · 2.5 · 3 · 4 · 5 · 6
 - ⊛ T 10 · 15 · 20 · 25 · 27 · 30
 - ⊛ SQ 0 · 1 · 2 · 3
 - 1/4" 5 · 6 · 7 · 8 · 9 · 10 · 11 · 12 · 13 mm

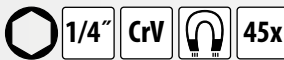

№ 18419 Характеристики



6



КОМПЛЕКТ ОТВЕРТКИ

- ⊖ S 1,5x50 · 2x50 · 2,5x50 mm
- ⊕ PH 000x50 · 00x50 · 0x50 mm



№ 18416 Характеристики

6



КОМПЛЕКТ ОТВЕРТКИ, ТИП TORX

- ⊛ T 4 · 5 · 6 · 7 · 8 · 9 · 10x50 mm



№ 18417 Характеристики



6



КОМПЛЕКТ ЕЛЕКТРООТВЕРТКИ, ПРЕЦИЗНИ

- ⊖ S 2,4 · 3,0 mm
- ⊕ PH 0 · 1
- ⊛ T 6 · 8



№ 18415 Характеристики



10

FESTA



NEW



FESTA
ФАЗОМЕР
 · AC - 110 V, 250 V



№	Характеристики	
18427		24

ФАЗОМЕР
 DIN VDE 0680
 73/23 EEC



№	Характеристики	
18426	0 - 250 V	1

FESTA
ОТВАРАЧКА

№	Характеристики	
18437		5



КОМПЛЕКТ ПРЕЦИЗНИ ОТВЕРТКИ

⊖ S 1,4 · 2,0 · 2,4 · 3,0 mm
 ⊕ PH 0 · 1



6x HOBBY

№	Характеристики	
18408		10



**ЪГЛОВ ДЪРЖАЧ
 ЗА БИТОВЕ, 90°**



№	Характеристики	
18910		25



ТРЕСЧОТКА ЗА БИТОВЕ



№	Характеристики	
18435	93 mm	1



КОМПЛЕКТ ПРЕЦИЗНИ ОТВЕРТКИ

⊖ S 1,0 · 1,2 · 1,4 · 1,8 · 2,4 · 3,0 mm
 ⊕ PH 00 · 0 · 1



11x HOBBY

№	Характеристики	
18409		48





ТОРСИОНЕН БИТ PH - 50 MM



№	Характеристики	
18715	PH1 x 50 mm	1
18716	PH2 x 50 mm	1
18717	PH3 x 50 mm	1



ТОРСИОНЕН БИТ PZ - 50 MM



№	Характеристики	
18710	PZ1 x 50 mm	1
18711	PZ2 x 50 mm	1
18712	PZ3 x 50 mm	1



ТОРСИОНЕН БИТ T - 50 MM

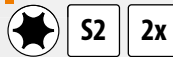

№	Характеристики	
18720	T10 x 50 mm	1
18721	T15 x 50 mm	1
18722	T20 x 50 mm	1
18723	T25 x 50 mm	1
18724	T30 x 50 mm	1
18725	T40 x 50 mm	1



ТОРСИОНЕН БИТ

- ⊕ PH 2 · 2
- ⊕ PZ 2
- ⊕ T 15 · 15 · 20 · 20 · 25 · 30 · 40

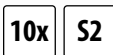

№	Характеристики	
18432		1



Професионални битове от висококачествена и устойчива S2 стомана

Технология на коване

Накрайници, изработени по специална технология с прецизно коване. Тя дава възможност за постигане на висока точност във формата и с до 20% по-висока твърдост в сравнение с други аналогични продукти.

TiN покритие

Накрайници, снабдени с двойно TiN покритие- титаниев нитрид, известен с високата си твърдост, сходна с тази на диаманта. Покритието увеличава износоустойчивостта на накрайниците и предотвратява изхлъзване от инструмента.

Диамантено покритие

Покритие от фини диамантени частици, което гарантира отличен захват на накрайника в инструмента и предотвратява изхлъзването му.

Набраздена повърхност

Набраздена повърхност на накрайника- изключително ефективна защита срещу изхлъзване от инструмента.

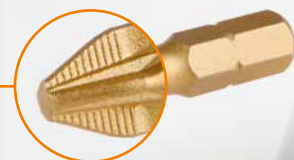



БИТ PH

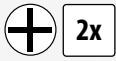

№	Характеристики	
18632A	PH2 x 25 mm	1
18633A	PH3 x 25 mm	1



БИТ PZ

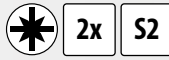

№	Характеристики	
18636A	PZ1 x 25 mm	1
18637A	PZ2 x 25 mm	1
18638A	PZ3 x 25 mm	1



БИТ T

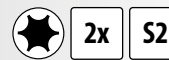

№	Характеристики	
18827A	T20 x 25 mm	1
18828A	T25 x 25 mm	1
18830A	T30 x 25 mm	1
18831A	T40 x 25 mm	1



БИТ С ДИАМАНТЕНО ПОКРИТИЕ, PH



№	Характеристики	
18770	PH1 x 25 mm	5
18771	PH2 x 25 mm	5
18772	PH3 x 25 mm	5



БИТ С ДИАМАНТЕНО ПОКРИТИЕ, PZ



№	Характеристики	
18775	PZ1 x 25 mm	5
18776	PZ2 x 25 mm	5
18777	PZ3 x 25 mm	5



БИТ S



№	Характеристики	
18620	S 3 x 25 mm	5
18621	S 4 x 25 mm	5
18623	S 5 x 25 mm	5
18625	S 6 x 25 mm	5
18627	S 7 x 25 mm	5
18628	S 8 x 25 mm	5



БИТ PH

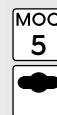

№	Характеристики	
18630	PH0 x 25 mm	5
18631	PH1 x 25 mm	5
18632	PH2 x 25 mm	5
18633	PH3 x 25 mm	5
18634	PH4 x 25 mm	5



БИТ PZ



№	Характеристики	
18635	PZ0 x 25 mm	5
18636	PZ1 x 25 mm	5
18637	PZ2 x 25 mm	5
18638	PZ3 x 25 mm	5
18639	PZ4 x 25 mm	5



БИТ PH

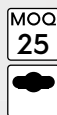

№	Характеристики	
18685	PH2 x 25 mm	25



БИТ PZ

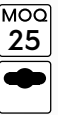

№	Характеристики	
18680	PZ2 x 25 mm	25



БИТ PH

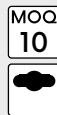

№	Характеристики	
18640	PH1 x 70 mm	10
18641	PH2 x 70 mm	10



БИТ PZ



№	Характеристики	
18645	PZ1 x 70 mm	10
18646	PZ2 x 70 mm	10



БИТ PH

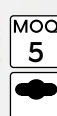
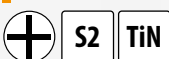

№	Характеристики	
18760	PH0 x 25 mm	5
18761	PH1 x 25 mm	5
18762	PH2 x 25 mm	5
18763	PH3 x 25 mm	5
18764	PH4 x 25 mm	5



БИТ PZ

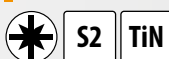

№	Характеристики	
18765	PZ0 x 25 mm	5
18766	PZ1 x 25 mm	5
18767	PZ2 x 25 mm	5
18768	PZ3 x 25 mm	5
18769	PZ4 x 25 mm	5



БИТ S



№	Характеристики	
18750	S 3 x 25 mm	5
18751	S 4 x 25 mm	5
18753	S 5 x 25 mm	5
18755	S 6 x 25 mm	5



БИТ Н



MOQ 5



№	Характеристики	MOQ
18800	H 1,5 x 25 mm	5
18801	H 2,0 x 25 mm	5
18802	H 2,5 x 25 mm	5
18803	H 3,0 x 25 mm	5
18804	H 4,0 x 25 mm	5
18805	H 5,0 x 25 mm	5
18806	H 5,5 x 25 mm	5
18807	H 6,0 x 25 mm	5



БИТ ТТА



MOQ 5



№	Характеристики	MOQ
18835	ТТa 5 x 25 mm	10
18836	ТТa 6 x 25 mm	5
18837	ТТa 7 x 25 mm	5
18838	ТТa 8 x 25 mm	5
18839	ТТa 9 x 25 mm	5
18840	ТТa 10 x 25 mm	5
18841	ТТa 15 x 25 mm	5
18842	ТТa 20 x 25 mm	5
18843	ТТa 25 x 25 mm	5
18844	ТТa 27 x 25 mm	5
18845	ТТa 30 x 25 mm	5
18846	ТТa 40 x 25 mm	5
18847	ТТa 45 x 25 mm	5



БИТ Т



MOQ 5



№	Характеристики	MOQ
18820	T5 x 25 mm	5
18821	T6 x 25 mm	5
18822	T7 x 25 mm	5
18823	T8 x 25 mm	5
18824	T9 x 25 mm	5
18825	T10 x 25 mm	5
18826	T15 x 25 mm	5
18827	T20 x 25 mm	5
18828	T25 x 25 mm	5
18829	T27 x 25 mm	5
18830	T30 x 25 mm	5
18831	T40 x 25 mm	5
18832	T45 x 25 mm	5



БИТ НТА



MOQ 5



№	Характеристики	MOQ
18810	HTa 1,5 x 25 mm	5
18811	HTa 2,0 x 25 mm	5
18812	HTa 2,5 x 25 mm	5
18813	HTa 3,0 x 25 mm	5
18814	HTa 4,0 x 25 mm	5
18815	HTa 5,0 x 25 mm	5
18816	HTa 5,5 x 25 mm	5
18817	HTa 6,0 x 25 mm	5



БИТ SQ



MOQ 5



№	Характеристики	MOQ
18850	SQ 0 x 25 mm	5
18851	SQ 1 x 25 mm	5
18852	SQ 2 x 25 mm	5
18853	SQ 3 x 25 mm	5



БИТ Т



MOQ 3



№	Характеристики	MOQ
17980	T30 x 35 mm	3
17981	T40 x 35 mm	3
17982	T45 x 35 mm	3
17983	T50 x 35 mm	3



БИТ SD



MOQ 5



№	Характеристики	MOQ
18855	SD 6 x 25 mm	5
18856	SD 8 x 25 mm	5



БИТ Т



MOQ 3



№	Характеристики	MOQ
17970	T20 x 75 mm	3
17971	T25 x 75 mm	3
17972	T30 x 75 mm	3
17973	T40 x 75 mm	3



БИТ TW



MOQ 5



№	Характеристики	MOQ
18860	TW 1 x 25 mm	5
18861	TW 2 x 25 mm	5
18862	TW 3 x 25 mm	5
18863	TW 4 x 25 mm	5



БИТ TS



MOQ 5



№	Характеристики	MOQ
18864	TS 4 x 25 mm	5
18865	TS 6 x 25 mm	5



БИТ 5/32", 3/16"



MOQ 5



№	Характеристики	MOQ
18866	5/32 x 25 mm	5
18867	3/16 x 25 mm	5



БИТ XZN



MOQ 5



№	Характеристики	MOQ
18870	M4 x 25 mm	5
18871	M5 x 25 mm	5
18872	M6 x 25 mm	5
18873	M8 x 25 mm	5
18874	M10 x 25 mm	5



АДАПТЕР ЗА БИТОВЕ

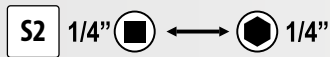

MOQ 5



№	Характеристики	MOQ
18868	25 mm	5



АДАПТЕР ЗА БИТОВЕ

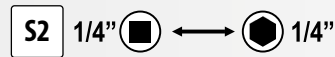

MOQ 5



№	Характеристики	MOQ
18869	50 mm	5



FESTA
INDUSTRY

БИТ ЗА ГИПСОКАРТОН



№	Характеристики	MOQ
18795	PH 2 x 25 mm	24



FESTA
INDUSTRY

БИТ ЗА ГИПСОКАРТОН



№	Характеристики	MOQ
18796	PH 2 x 55 mm	24



FESTA
INDUSTRY

АДАПТЕР
ТРЕСЧОТКА, 1/4" - БИТ

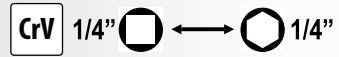

№	Характеристики	MOQ
18619	1/4"	5



FESTA
INDUSTRY

МАГНИТЕН ДЪРЖАЧ
ЗА БИТОВЕ



№	Характеристики	MOQ
18600	1/4' x 60 mm	5



FESTA
INDUSTRY

МАГНИТЕН ДЪРЖАЧ
ЗА БИТОВЕ

* Quick grip | Цанга за бърза смяна

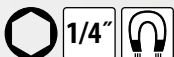

№	Характеристики	MOQ
18601	1/4' x 60 mm	5



FESTA
INDUSTRY

МАГНИТЕН ДЪРЖАЧ
ЗА БИТОВЕ

* Sa granitnikom | Със стопер

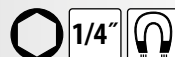

№	Характеристики	MOQ
18602	1/4' x 60 mm	5



FESTA
INDUSTRY

МАГНИТЕН ДЪРЖАЧ
ЗА БИТОВЕ

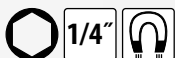

№	Характеристики	MOQ
18797	1/4' x 60 mm	1



FESTA
INDUSTRY

МАГНИТЕН ДЪРЖАЧ
ЗА БИТОВЕ

* Quick grip | Цанга за бърза смяна



№	Характеристики	MOQ
18798	1/4' x 60 mm	1



FESTA
INDUSTRY

МАГНИТЕН ДЪРЖАЧ
ЗА БИТОВЕ

* Със стопер



№	Характеристики	MOQ
18799	1/4' x 60 mm	1



FESTA
INDUSTRY

МАГНИТЕН ДЪРЖАЧ
ЗА БИТОВЕ



№	Характеристики	MOQ
18605	150 mm	25



FESTA

АДАПТЕР, SDS+
ЗА БИТОВЕ 1/4"



№	Характеристики	MOQ
20743	75 mm	1



ДЪРЖАЧ ЗА БИТОВЕ



№	Характеристики	MOQ
18607	80 mm	25

FESTA

МАГНИТЕН ДЪРЖАЧ
ЗА БИТОВЕ



№	Характеристики
18609	90mm



25

**WEST
BERG**

АДАПТЕР
БИТ 1/4" ЗА SDS+

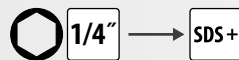

№	Характеристики
20742	



1

**FESTA
INDUSTRY**

КОМПЛЕКТ
БИТОВЕ
И АДАПТЕРИ

- 10x ⊕ 18630 PH0
- 10x ⊕ 18631 PH1
- 10x ⊕ 18632 PH2
- 10x ⊕ 18633 PH3
- 10x ⊕ 18635 PZ0
- 10x ⊕ 18636 PZ1
- 10x ⊕ 18637 PZ2
- 10x ⊕ 18638 PZ3
- 10x ⊕ 18761 PH1 TiN
- 10x ⊕ 18762 PH2 TiN
- 10x ⊕ 18763 PH3 TiN
- 10x ⊕ 18766 PZ1 TiN
- 10x ⊕ 18767 PZ2 TiN
- 10x ⊕ 18768 PZ3 TiN
- 10x ⊕ 18770 PH1 DIAMANT
- 10x ⊕ 18771 PH2 DIAMANT
- 10x ⊕ 18775 PZ1 DIAMANT
- 10x ⊕ 18776 PZ2 DIAMANT
- 10x ⊙ 18814 4,0HTα
- 10x ⊙ 18815 5,0HTα
- 10x ⊙ 18842 20TTα
- 10x ⊙ 18845 30TTα
- 10x ⊕ 18795 PH2 За гипсокартон
- 5x 18612 Адаптер 1/4" 8mm
- 5x 18613 Адаптер 1/4" 10mm
- 5x 18600 1/4" 60mm Магнитен държач за битове
- 5x 18601 1/4" 60mm Магнитен държач за битове с бърза смяна
- 5x 18602 1/4" 65mm Магнитен държач за битове със стопер

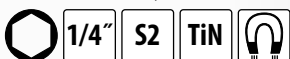

№	Характеристики
18993	

1

**FESTA
INDUSTRY**

КОМПЛЕКТ
БИТОВЕ

- 10x ⊕ 18631 PH1
- 10x ⊕ 18632 PH2
- 10x ⊕ 18633 PH3
- 10x ⊕ 18636 PZ1
- 10x ⊕ 18637 PZ2
- 10x ⊕ 18638 PZ3
- 10x ⊕ 18761 PH1 TiN
- 10x ⊕ 18762 PH2 TiN
- 10x ⊕ 18763 PH3 TiN
- 10x ⊕ 18766 PZ1 TiN
- 10x ⊕ 18767 PZ2 TiN
- 10x ⊕ 18768 PZ3 TiN
- 10x ⊙ 18804 H 4
- 10x ⊙ 18805 H 5
- 10x ⊙ 18825 T 10
- 10x ⊙ 18826 T 15
- 10x ⊙ 18827 T 20
- 10x ⊙ 18828 T 25
- 10x ⊙ 18830 T 30
- 10x ⊙ 18831 T 40

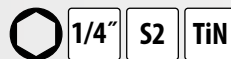

№	Характеристики
18994	

1

**FESTA
INDUSTRY**

АДАПТЕР, 1/4"

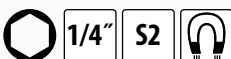

№	Характеристики
18610	6 mm
18611	7 mm
18612	8 mm



№	Характеристики
18613	10 mm
18614	12 mm
18615	13 mm

**FESTA
INDUSTRY**

АДАПТЕР, 1/4"

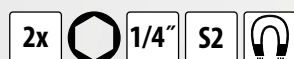

№	Характеристики
18610A	6 mm
18611A	7 mm
18612A	8 mm



№	Характеристики
18613A	10 mm
18614A	12 mm
18615A	13 mm

FESTA

КОМПЛЕКТ АДАПТЕРИ

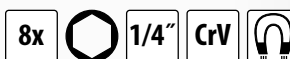

№	Характеристики
18618	6, 7, 8, 9, 10, 11, 12, 13 mm



12





FESTA

КОМПЛЕКТ БИТОВЕ

- bit 25 mm S 3 · 4 · 5 · 6
- PH 0 · 1 · 2 · 3
- PZ 0 · 1 · 2 · 3
- H 3 · 4 · 5 · 6
- T 10 · 15 · 20 · 25 · 27 · 30 · 40
- TТа 10 · 15 · 20 · 25 · 27 · 30 · 40

Държач

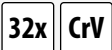

№ 18908 Характеристики



1



FESTA

КОМПЛЕКТ БИТОВЕ

- S 3 · 4 · 5 · 6
- PH 1 · 2 · 3
- PZ 1 · 2 · 3
- H 3 · 4 · 5 · 6
- T 10 · 15 · 20 · 25 · 27 · 30 · 40
- TТа 10 · 15 · 20 · 25 · 27 · 30 · 40

· Магнитен държач за битове с бърза смяна

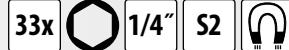

№ 18905 Характеристики



10



FESTA

КОМПЛЕКТ БИТОВЕ

- S 4 · 5 · 6
- PH 1 · 2 · 3
- PZ 1 · 2 · 3
- H 3 · 4 · 5 · 6
- T 10 · 15 · 20 · 25 · 27 · 30 · 40
- TТа 10 · 15 · 20 · 25 · 27 · 30 · 40

· Магнитен държач за битове с бърза смяна

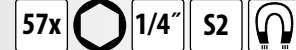

№ 18906 Характеристики



6

FESTA

КОМПЛЕКТ БИТОВЕ

- HTa 2 · 2.5 · 3 · 4 · 5 · 6
5/32" · 9/64" · 1/8"
7/64" · 3/32" · 5/64"
- SD 4 · 6 · 8 · 10
- TS 6 · 8 · 10
- TW 1 · 2 · 3 · 4
- TТа 8 · 10 · 15 · 20 · 25 · 27 · 30 · 35 · 40

Магнитен държач за битове



№ 18900 Характеристики



10

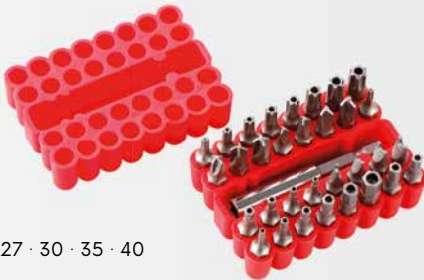

FESTA

КОМПЛЕКТ БИТОВЕ

- S 3 · 4 · 4.5 · 5 · 5.5 · 6 · 6.5 · 7 · 8
- PH 0 · 1 · 2 · 3
- PZ 0 · 1 · 2 · 3
- SO 0 · 1 · 2 · 3
- T 8 · 10 · 15 · 20 · 25 · 27 · 30 · 40 · 45
- TТа 8 · 10 · 15 · 20 · 25 · 27 · 30 · 35 · 40
- H 1.5 · 2 · 2.5 · 3 · 4 · 5 · 5.5 · 6 · 8 mm
1/16" · 5/64" · 3/32" · 7/64" · 1/8" · 9/64"
5/32" · 3/16" · 7/32" · 1/4"
- HTa 2 · 2.5 · 3 · 4 · 5 · 6 mm
5/64" · 3/32" · 7/64" · 1/8" · 9/64" · 5/32"
- SD 4 · 6 · 8 · 10
- TS 6 · 8 · 10
- TW 1 · 2 · 3 · 4
- 2-wing 1 · 2 · 3
- XZN 5 · 6 · 8

Магнитен държач за битове

Y-държач

1/4" DR държач за битове

1/4" Адаптер: 25mm, 50mm

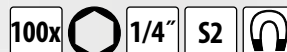

№ 18909 Характеристики



24



FESTA

КОМПЛЕКТ БИТОВЕ

- S 3 · 4 · 5 · 6 · 7
- PH 0 · 1 · 2 · 3
- PZ 1 · 2 · 3
- H 2 · 2.5 · 3 · 4 · 5 · 6
- T 10 · 15 · 20 · 25 · 30 · 40

Магнитен държач за битове



№ 18901 Характеристики



10



КОМПЛЕКТ БИТОВЕ

- ⊖ S 4 · 5 · 6 · 7
- ⊕ PH 1 · 2 · 3
- ✱ PZ 1 · 2 · 3
- H 4 · 5 · 6
- ⊛ T 10 · 15 · 20 · 25
- SQ 1 · 2 · 3

20x S2



10x CrV TiN

№ 18907 Характеристики 10



КОМПЛЕКТ БИТОВЕ

- ⊖ S 4 · 5 · 6 · 7
- ⊕ PH 1 · 2 · 3
- ✱ PZ 1 · 2 · 3



10x CrV TiN

№ 18440 Характеристики 10

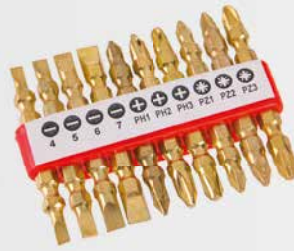

КОМПЛЕКТ БИТОВЕ

- ⊖ S 3 · 5 · 7
- ⊕ PH 1 · 2 · 3

Магнитен държач за битове



7x HOBBY

№ 18430 Характеристики 20



КОМПЛЕКТ БИТОВЕ С ДЪРЖАЧ

- ⊕ S 3 · 3,5 · 4 · 5,5
- ✱ PH 0 · 1 · 2 · 3
- ⊖ PZ 0 · 1 · 2 · 3
- H 3 · 4
- ⊛ T 10 · 15 · 20 · 25 · 27 · 30
- 1/4" 4 · 4,5 · 5 · 5,5 · 6 · 7 · 8 · 9 · 10 · 11 · 13

Магнитна отвертка 1/4"
Магнитен държач за битове

CrV 1/4"

40x



№ 18915 Характеристики 10



ГЕДОРЕ КОМПЛЕКТ

- ⊖ S 5 · 6 mm
- ⊕ PH 1 · 2
- H 3 · 4 · 5 · 6
- ⊛ T 15 · 20 · 25 · 30
- 1/4" 4 · 5 · 6 · 7 · 8 · 9 · 10 · 12 · 13 mm

75 mm 1/4"
 1/4" ↔ 1/4"

1/4" CrV

23x

№ 18421 Характеристики 10





- 1/2", 1/4"
- 1/4" · 4-5-6-7-8-9mm
- 1/2" · 10-12-13-14-17-19mm
- 1/4" · 4-4.5-5-5.5-6-7-8-9-10-11-12-13-14mm
- 1/2" · 12-13-14-15-16-17-18-19-20-21-22-24mm
- 1/2", 1/4"
- 1/4" 1/4"
- 1/4" · 150mm
- 1/2" · 254mm
- 1/2", 1/4"
- 1/2" · 16-21mm
- 1/4" · 150mm
- 1/2" · E10-E12-E14-E16-E18-E20-E22-E24
- 1/4" S 3 · 4 · 5 · 6
- 1/4" PH 0 · 1 · 2
- 1/4" PZ 0 · 1 · 2
- 1/4"
- 1/4" · S 4 · 5,5 · 6,5
- 1/4" PH 1 · 2 · 3
- 1/4" PZ 2 · 3
- 1/4" H 3 · 4 · 5 · 6
- 1/4" T 8 · 10 · 15 · 20 · 25
- 1/4" ТТa 10 · 15 · 20 · 25 · 40
- 2 · 2,5 · 3 · 4 · 5 · 6 · 7 · 8 · 10mm
- 8-9-10-11-12-13-14-15-16-17-18-19mm
- S 4x100 · 6,5x150
- PH 2x100 · 3x150
- 180mm
- 160mm
- 160mm
- 250mm
- 300g

FESTA

ГЕДОРЕ КОМПЛЕКТ

122x CrV S2 1/4" 1/2" 72T

№ 17238 Характеристики 122 бр.



1



ГЕДОРЕ КОМПЛЕКТ

- 160 mm
- 160 mm
- 300 g
- 1/4" 45T
- 4 · 5 · 6 · 7 · 8 · 9 · 10 · 11 · 12 · 13 mm
- 1/4" 75 mm
- 1,5 · 2 · 2,5 · 3 · 4 · 5 · 6 · 8 · 10 mm
- S 3 · 4 · 5 · 6 mm
- PH 0 · 1 · 2 · 3
- PZ 0 · 1 · 2 · 3
- T 10 · 15 · 20 · 25
- H 3 · 4 · 5 · 6
- S 5x100 mm
- PH 1x100 · 2x100 mm
- S 2,5x50 mm
- PH 00x50 · 0x50 mm
- AC 100-250 V
- 200 mm max. 22 mm
- 10x11 · 12x13 · 14x15 · 16x17 mm
- 18 mm
- 2 mm 13 mm

60x



35x

№ 17259 Характеристики 5

№ 17260



10

№ 17260 Характеристики 10

17260



ГЕДОРЕ КОМПЛЕКТ

- 1/4" 5 · 6 · 7 · 8 · 9 · 10 · 11 · 12 mm
- 1/4"
- 1/4"
- AC 230 V
- PH 0, SL 3
- 9x 1,5-10 mm
- 160 mm
- S 3 · 4 · 5 · 6 mm
- PH 0 · 1 · 2 · 3
- H 4 · 5
- PH 2x100, S 6x100
- 18 mm
- 1 m
- 300 g

39x



№ 17247

№ 17247 Характеристики 10

FESTA

10 years
guarantee



Cr-Mo

- за промишлени и сервизни приложения
- висококачествена хром-ванадиева стомана
- тресчотки със 72 зъба за максимална прецизност
- всички компоненти са в съответствие със стандарт DIN
- набраздени за по-добро сцепление
- солиден куфар със стоманени закопчалки.



FESTA

ГЕДОРЕ КОМПЛЕКТ, 171 ЧАСТИ

- 1/2", 1/4", 3/8"
- 1/4" · 4-5-6-7-8-9-10mm
- 3/8" · 10-11-12-13-14-15mm
- 1/2" · 16-17-18-19-22mm
- 1/4" · 4-4.5-5-5.5-6-7-8-9-10-11-12-13-14mm
- 3/8" · 10-11-12-13-14-15-16-17-18-19mm
- 1/2" · 10-11-12-13-14-15-16-17-18-19-20-21-22-24-27-30-32mm
- 1/4" · E4-E5-E6-E7-E8
- 3/8" · E10-E11-E12-E14-E16-E18
- 1/2" · E20-E24
- 1/2" · 24x
- 1/4" · 20x
- 1/4" · 30x
- 1/4" · 50 mm, 100 mm
- 1/2" · 125 mm, 250 mm
- 3/8" · 150 mm
- 1/2" · 16-21mm
- 3/8" · 18mm
- 1/2", 1/4", 3/8" bit holder
- 1/2", 1/4", 3/8"
- 1/4" · 150mm
- 1/4" · 115mm
- Inbus 7X



10 years
guarantee



CrV S2 1/4" 1/2" 3/8" 72T 171x ERGO HANDLE

№ 17237 Характеристики 2



FESTA

ГЕДОРЕ КОМПЛЕКТ, 12 ЧАСТИ

- 1/2" · 72T
- 1/2" · 125 mm
- 1/2" · 10-11-12-13-14-15-17-19-22-24 mm



CrV 1/2" 72T 12x ERGO HANDLE

Č.p. specifikace 17245 15



FESTA

ГЕДОРЕ КОМПЛЕКТ, 12 ЧАСТИ

- 1/2" · 72T
- 1/2" · 125 mm
- 1/2" · 10-11-12-13-14-15-17-19-22-24 mm



CrV 1/2" 72T 12x ERGO HANDLE

Č.p. specifikace 17229 8



FESTA

ГЕДОРЕ КОМПЛЕКТ, 20 ЧАСТИ

- 1/2" · 72 T
- 1/2" · 75, 125 mm
- 1/2"
- 1/2" · 10-11-12-13-14-15-16-17-18-19-22-24 mm
- 1/2" · 17mm, 19mm
- 3 way adapter
- 16mm, 21mm



CrV 1/2" 72T 20x ERGO HANDLE

Č.p. specifikace 17230 4



FESTA

ГЕДОРЕ КОМПЛЕКТ, 36 ЧАСТИ

- 1/4" · 72 T
- 1/4" · 50, 100 mm
- 1/4"
- 1/4" · 4-5-5.5-6-7-8-10-11-12-13 mm
- 1/4" · 6-7-8-10-12-13 mm
- 3 way adapter
- 4 x
- 11x
- 1x



CrV S2 1/4" 72T 36x ERGO HANDLE

Č.p. specifikace 17231 10



FESTA

ГЕДОРЕ КОМПЛЕКТ, 46 ЧАСТИ

- 1/4"
- 1/4"
- 1/4" · 4-4.5-5-5.5-6-7-8-9-10-11-12-13-14 mm
- 1/4" · 50 mm, 100 mm
- 1/4"
- 1/4"
- 21 x
- 1/4"
- L 1/4"



CrV S2 1/4" 72T 45x ERGO HANDLE

Č.p. specifikace 17233 10



FESTA

ГЕДОРЕ КОМПЛЕКТ, 73 ЧАСТИ

- 1/2", 1/4" · 72T
- 1/4"
- 16 mm, 21 mm
- 1/4" · 10-11-12-13-14-15-16-17-18-19-20-21-22-23-24-27 mm
- 1/4" · 100 mm
- 1/2" · 125 mm, 250 mm
- 1/4"
- 1 x
- 1/4" · 4-5-5.5-6-7-8-10-11-12-13 mm
- 33 x



CrV S2 1/4" 1/2" 72T 73x ERGO HANDLE

Č.p. specifikace 17234 4





FESTA

ГЕДОРЕ КОМПЛЕКТ, 94 ЧАСТИ

- 1/2", 1/4" · 72T
- 1/4"
- 16 mm, 21 mm
- 1/4" · 4 -4,5-5-5,5-6-7-8-9-10-11-12-13-14 mm
- 1/2" · 10-11-12-13-14-15-16-17-18-19-20-21-22-23-24-27-30-32 mm
- 1/4" · 6-7-8-9-10-11-12-13 mm
- 1/2" · 14-15-17-19 mm
- 1/4" · 50 mm, 100 mm
- 1/2" · 125 mm, 250 mm
- 1/4"
- 5/16" bit holder
- 17x
- 15x
- 3 way adapter
- 3 x
- 1/4"
- L 1/4"
- 1/2", 1/4"

CrV S2 1/4" 1/2" 72T 94x ERGO HANDLE



Č.p.	specifikace
17235	4

FESTA

ГЕДОРЕ КОМПЛЕКТ, 110 ЧАСТИ

- 1/2", 1/4" · 72T
- 150 mm
- 16 mm, 21 mm
- 1/4" · 4 -4,5-5-5,5-6-7-8-9-10-11-12-13-14 mm
- 1/2" · 10-11-12-13-14-15-16-17-18-19-20-21-22-24-27-30-32 mm
- 1/4" · 6-7-8-9-10-11-12-13 mm
- 1/2" · 14-15-17-19-22 mm
- 1/4" · 50 mm, 100 mm
- 1/2" · 125 mm, 250 mm
- E · 4-5-6-7-8-10-11-12-14-16-18-20-24-27-30-32 mm
- 1/2", 1/4"
- 5/16" bit holder
- 18 x
- 17 x
- 3 way adapter
- 4 x
- 1/4"
- L 1/4"

CrV S2 1/4" 1/2" 72T 110x ERGO HANDLE



Č.p.	specifikace
17236	4

FESTA

ГЕДОРЕ КОМПЛЕКТ

- 1/2", 1/4"
- 1/4" · 4-5-6-7-8-9mm
- 1/2" · 10-12-13-14-17-19mm
- 1/4" · 4-4,5-5-5,5-6-7-8-9-10-11-12-13-14mm
- 1/2" · 12-13-14-15-16-17-18-19-20-21-22-24mm
- 1/2", 1/4"
- 1/4"/4" → 1/4"/4"
- 1/4" · 150mm
- 1/2" · 254mm
- 1/2", 1/4"
- 1/2" · 16-21mm
- 1/4" · 150mm
- 1/2" · E10-E12-E14-E16-E18-E20-E22-E24
- 1/4" · S 3 · 4 · 5 · 6
- 1/4" · PH 0 · 1 · 2
- 1/4" · PZ 0 · 1 · 2
- 1/4" · S 4 · 5,5 · 6,5
- 1/4" · PH 1 · 2 · 3
- 1/4" · PZ 2 · 3
- 1/4" · H 3 · 4 · 5 · 6
- 1/4" · T 8 · 10 · 15 · 20 · 25
- 1/4" · TTα 10 · 15 · 20 · 25 · 40
- 2 · 2,5 · 3 · 4 · 5 · 6 · 7 · 8 · 10mm
- 8-9-10-11-12-13-14-15-16-17-18-19mm
- S 4x100 · 6,5x150
- PH 2x100 · 3x150
- 180mm
- 160mm
- 160mm
- 250mm
- 300g

CrV S2 1/4" 1/2" 72T 122x ERGO HANDLE



Č.p.	specifikace
17238	122 ks 1



FESTA



FESTA



- висока ергономичност, двукомпонентна дръжка, изработена от омекотена TPE гума
- 72 зъба за максимална прецизност
- висококачествена хромванадиева стомана
- система QUICK RELEASE за лесно освобождаване и смяна на вложките



FESTA

ТРЕСЧОТКА



Ч.п.	спецификация	дължина	пакети
17297	1/4"	155 mm	6
17298	3/8"	210 mm	5
17299	1/2"	255 mm	4

FESTA

ТРЕСЧОТКА



Ч.п.	спецификация	дължина	пакети
17240	1/4"	155 mm	10
17241	3/8"	200 mm	10
17242	1/2"	250 mm	5

FESTA

ТРЕСЧОТКА



Ч.п.	спецификация	дължина	пакети
17294	1/4"	155 mm	6
17295	3/8"	205 mm	10
17296	1/2"	255 mm	4

FESTA

ОБРАТИМА ТРЕСЧОТКА 1/4"



Ч.п.	спецификация	пакети
17292	1/4"	1

ТРЕСЧОТКА

HOBBY



Ч.п.	спецификация	пакети
17243	1/4" 43T	25
17244	1/2" 39T	25

FESTA

ВЪТРОК ОТВЕРТКА

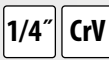

Ч.п.	спецификация	пакети
18603	1/4" 150 mm	10



FESTA

ВЛОЖКИ 1/4"



№. п.	спецификации	Кол.
17820	4 mm • 25 mm	10
17821	4,5 mm • 25 mm	10
17822	5 mm • 25 mm	10
17823	5,5 mm • 25 mm	10
17824	6 mm • 25 mm	10
17825	7 mm • 25 mm	10
17826	8 mm • 25 mm	10
17827	9 mm • 25 mm	10
17828	10 mm • 25 mm	10
17829	11 mm • 25 mm	10
17830	12 mm • 25 mm	10
17831	13 mm • 25 mm	10
17832	14 mm • 25 mm	10



FESTA

ВЛОЖКИ 1/2"



№. п.	спецификации	Кол.
17308	8 mm • 38 mm	10
17309	9 mm • 38 mm	10
17310	10 mm • 38 mm	10
17311	11 mm • 38 mm	10
17312	12 mm • 38 mm	10
17313	13 mm • 38 mm	10
17314	14 mm • 38 mm	10
17315	15 mm • 38 mm	10
17316	16 mm • 38 mm	10
17317	17 mm • 38 mm	10
17318	18 mm • 38 mm	10
17319	19 mm • 38 mm	10
17320	20 mm • 38 mm	10
17321	21 mm • 38 mm	10
17322	22 mm • 38 mm	10
17324	24 mm • 38 mm	10
17327	27 mm • 42 mm	20
17330	30 mm • 42 mm	25
17332	32 mm • 42 mm	20
17333	34 mm • 42 mm	20
17334	36 mm • 42 mm	20



FESTA

ВЛОЖКИ 3/4"



№. п.	спецификации	Кол.
17835	17 mm • 48 mm	10
17836	18 mm • 48 mm	10
17837	19 mm • 48 mm	10
17838	21 mm • 48 mm	10
17839	22 mm • 48 mm	10
17840	24 mm • 48 mm	10
17841	26 mm • 48 mm	10
17842	27 mm • 52 mm	10
17843	28 mm • 52 mm	10
17844	30 mm • 52 mm	10
17845	32 mm • 52 mm	10
17846	33 mm • 55 mm	10
17847	36 mm • 60 mm	10
17848	38 mm • 60 mm	10
17849	41 mm • 65 mm	10
17850	46 mm • 65 mm	10
17851	50 mm • 70 mm	10
17852	55 mm • 75 mm	10
17853	60 mm • 78 mm	10
17854	65 mm • 82 mm	10
17855	70 mm • 82 mm	10
17856	75 mm • 88 mm	10



FESTA

ВЛОЖКИ MULTILOCK 1/2"



№. п.	спецификации	Кол.
17910	8 mm • 38 mm	10
17914	12 mm • 38 mm	10
17916	14 mm • 38 mm	10
17922	21 mm • 38 mm	10
17924	24 mm • 38 mm	10
17926	30 mm • 38 mm	10



FESTA

ДЪЛБОКИ ВЛОЖКИ 1/4"



№. п.	спецификации	Кол.
17860	4 mm • 50 mm	10
17861	5 mm • 50 mm	10
17862	6 mm • 50 mm	10
17863	7 mm • 50 mm	10
17864	8 mm • 50 mm	10
17865	9 mm • 50 mm	10
17866	10 mm • 50 mm	10
17867	11 mm • 50 mm	10
17868	12 mm • 50 mm	10
17869	13 mm • 50 mm	10
17870	14 mm • 50 mm	10



FESTA

ДЪЛБОКИ ВЛОЖКИ 1/2"



№. п.	спецификации	Кол.
17871	10 mm • 70 mm	10
17872	11 mm • 70 mm	10
17873	12 mm • 70 mm	10
17874	13 mm • 70 mm	10
17875	14 mm • 70 mm	10
17876	15 mm • 70 mm	10
17877	16 mm • 70 mm	10
17878	17 mm • 70 mm	10
17879	18 mm • 70 mm	10
17880	19 mm • 70 mm	10
17881	20 mm • 70 mm	10
17882	21 mm • 70 mm	10
17883	22 mm • 70 mm	10
17884	23 mm • 70 mm	10
17885	24 mm • 70 mm	10
17886	25 mm • 70 mm	10
17887	26 mm • 70 mm	10
17888	27 mm • 70 mm	10
17889	28 mm • 70 mm	10
17890	30 mm • 70 mm	10
17891	32 mm • 70 mm	10
17892	34 mm • 70 mm	10



FESTA

ВЛОЖКИ TORX 1/2"



№. п.	спецификации	Кол.
17943	E22	10
17944	E24	10



FESTA

ВЛОЖКИ TORX 1/4"



№. п.	спецификации	Кол.
17930	E4	10
17934	E8	10
17935	E10	10





FESTA

БИТ ПРАВ
ШЛИЦ 1/4"

CrV	S2	1/4"	
№. п.	спецификация	количество	
18920	S 4 mm	10	
18921	S 5,5 mm	10	
18922	S 7 mm	10	



FESTA

БИТ ТИП PHILIPS
(КРЪСТАТ ШЛИЦ) 1/4"

CrV	S2	1/4"	
№. п.	спецификация	количество	
18925	PH 1	10	
18926	PH 2	10	
18927	PH 3	10	



FESTA

БИТ ТИП
POZIDRIVE 1/4"

CrV	S2	1/4"	
№. п.	спецификация	количество	
18928	PZ 0	10	
18929	PZ 1	10	
18930	PZ 2	10	
18931	PZ 3	10	



FESTA

БИТ ТИП
TORX 1/2"

CrV	S2	1/2"	
№. п.	спецификация	количество	
18954	T 10	10	
18955	T 15	10	
18956	T 20	10	
18960	T 40	10	
18961	T 45	10	
18963	T 55	10	



FESTA

БИТ ТИП
TORX 1/4"

CrV	S2	1/4"	
№. п.	спецификация	количество	
18948	T 5	10	
18950	T 8	10	
18951	T 10	10	



FESTA

ШЕСТОСТЕНЕН БИТ
HEX 1/4"

CrV	S2	1/4"	
№. п.	спецификация	количество	
18934	3 mm	10	
18939	8 mm	10	



FESTA

БИТ ТИП
XZN 1/2"

CrV	S2	1/2"	
№. п.	спецификация	количество	
18971	M 16	10	



FESTA

АДАПТЕР, Т-ВЪРТОК

CrV		
№. п.	спецификация	количество
17420	1/4"	1
17421	1/2"	1
17422	3/4"	1



FESTA

АДАПТЕР

CrV		
№. п.	спецификация	количество
17410	A - 1/4" B - 3/8"	10
17411	A - 3/8" B - 1/4"	10
17412	A - 3/8" B - 1/2"	10
17413	A - 1/2" B - 3/8"	10
17414	A - 1/2" B - 3/4"	10
17415	A - 3/4" B - 1/2"	10
17416	A - 1/4" B - 1/2"	10



FESTA

УДЪЛЖИТЕЛ
ЗА ВЛОЖКА

CrV		
№. п.	спецификация	количество
17390	1/4" • 50 mm	1
17391	1/4" • 100 mm	1
17392	1/4" • 150 mm	1
17393	1/2" • 75 mm	1
17394	1/2" • 125 mm	1
17395	1/2" • 250 mm	1
17396	3/4" • 100 mm	1
17397	3/4" • 200 mm	1
17398	3/4" • 400 mm	1



FESTA

КАРДАН ЗА ВЛОЖКИ

CrV		
№. п.	спецификация	количество
17405	1/4" • 39 mm	10
17406	1/2" • 71 mm	10
17407	3/4" • 105 mm	10

FESTA

ВЪРТОК,
Т-ОБРАЗЕН

CrV		
№. п.	спецификация	количество
17382	1/4" • 115 mm	1
17383	3/8" • 190 mm	1
17384	1/2" • 250 mm	1
17385	3/4" • 460 mm	1
17386	1" • 640 mm	1



FESTA

ВЪРТОК,
Т-ОБРАЗЕН,
С ВЛОЖКА

CrV		
№. п.	спецификация	количество
17401	1/4" • 250 mm	1
17402	1/2" • 400 mm	1





FESTA

ТВЪРД ВЪРТОК
С ЧУПЕЩА ГЛАВА

CrV



№	Характеристики	1
17380	1/2" • 350 mm	1
17381	3/4" • 500 mm	1



FESTA

ВЪРТОК, Г-ОБРАЗЕН

CrV 1/2"



№	Характеристики	1
17427	1/2" • 60 x 320 mm	1



FESTA

УДЪЛЖИТЕЛ ЗА ВЛОЖКА,
ГЪВКАВ

CrV 1/4"



№	Характеристики	1
17400	1/4" • 150 mm	1

Stahlberg

АДАПТЕР,
ТРЕСЧОТКА 1/4" - БИТ

CrV

1/4" ↔ 1/4"

№	Характеристики	5
18619		5



MOQ 5



УНИВЕРСАЛНИ
ВЛОЖКИ

CrV 1/2"

№	Характеристики	1
17812	10 - 19 mm	1



1/4"



3/8"

УНИВЕРСАЛНИ ВЛОЖКИ

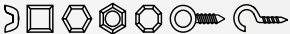

CrV 3/8"

№	Характеристики	1
17810	За винтове 7 - 19 mm • 52 mm x ø26 mm	1



1/4"



1/2"

УНИВЕРСАЛНИ ВЛОЖКИ



CrV 1/2"

№	Характеристики	5
17811	За винтове 11 - 32 mm • 83 mm x ø43 mm	5



КОМПЛЕКТ ДЪЛГИ ВЛОЖКИ DRIVELOCK

4-5-5.5-6-7-8-9-10-11-12-13 mm

CrV 1/4" 12x



№	Характеристики	10
17250		10



КОМПЛЕКТ ДЪЛГИ ВЛОЖКИ TORX

1/4" • 5-6-7-8-10

1/2" • 12-14-16-18

CrV 1/2" 1/4" 9x



№	Характеристики	4
17255		4



КОМПЛЕКТ АДАПТЕРИ

CrV 1/4" 3x



№	Характеристики	10
18604	1/4", 3/8", 1/2"	10

FESTA

УНИВЕРСАЛЕН КЛЮЧ

CrV 1/2"



№	Характеристики	10
17455		10



NEW



FESTA

КОМПЛЕКТ Т ОТВЕРТКИ ШЕСТОГРАМ + TORX

- Н 2.5 · 3 · 4 · 5 · 6 · 8 · 10 mm
- ★ Т 10 · 15 · 20 · 25 · 30 · 40 · 45

14x CrV



№	Характеристики	Иконка
18501		1

FESTA

КОМПЛЕКТ ШЕСТОГРАМ ОТВЕРТКИ

- 2 mm
- 2.5 mm
- 3 mm
- 4 mm
- 5 mm
- 6 mm
- 7 mm
- 8 mm
- 10 mm

9x CrV



№	Характеристики	Иконка
18494		6



FESTA

ОТВЕРТКА TORX

CrV



№	Характеристики	Иконка	№	Характеристики	Иконка
17350	T 7	10	17357	T 27	10
17351	T 8	10	17359	T 40	10
17352	T 9	10	17361	T 50	10
17353	T 10	10			

FESTA

КОМПЛЕКТ TORX ОТВЕРТКИ

- T 10
- T 15
- T 20
- T 25
- T 27
- T 30
- T 40
- T 45
- T 50

9x CrV



№	Характеристики	Иконка
18495		6



FESTA

ШЕСТОГРАМ, СТАНДАРТЕН

DIN 911 CrV



№	С.р.	спецификация	Иконка
18567	27 mm	100 x 250 mm	1
18572	32 mm	125 x 315 mm	1

FESTA

УДЪЛЖЕН ШЕСТОГРАМ, СТАНДАРТЕН

CrV



№	С.р.	спецификация	Иконка
18510	1,5 mm	14 x 74 mm	1
18511	2 mm	16 x 81 mm	1
18512	2,5 mm	18 x 88 mm	1
18513	3 mm	23 x 108 mm	1
18514	4 mm	24 x 107 mm	1
18515	5 mm	23 x 118 mm	1
18516	6 mm	32 x 135 mm	1
18518	8 mm	36 x 153 mm	1
18519	9 mm	38 x 155 mm	1
18520	10 mm	40 x 168 mm	1
18521	11 mm	40 x 230 mm	1
18522	12 mm	45 x 237 mm	1
18523	13 mm	45 x 260 mm	1
18524	14 mm	55 x 265 mm	1
18527	17 mm	60 x 298 mm	1

FESTA

УДЪЛЖЕН ШЕСТОГРАМ С ОБЛА ГЛАВА

CrV



№	С.р.	спецификация	Иконка
18575	1,5 mm	15 x 75 mm	1
18576	2 mm	17 x 81 mm	1
18577	2,5 mm	18 x 87 mm	1
18578	3 mm	20 x 96 mm	1
18579	4 mm	24 x 107 mm	1
18580	5 mm	30 x 120 mm	1
18581	6 mm	33 x 136 mm	1
18582	7 mm	34 x 144 mm	1
18583	8 mm	36 x 153 mm	1
18584	9 mm	38 x 155 mm	1
18585	10 mm	40 x 168 mm	1
18587	12 mm	45 x 237 mm	1
18588	13 mm	45 x 210 mm	1
18589	14 mm	55 x 265 mm	1
18593	17 mm	60 x 298 mm	1

FESTA

УДЪЛЖЕН ШЕСТОГРАМ, TORX

CrV



№	С.р.	спецификация	Иконка
18476	T45		1

FESTA

КОМПЛЕКТ ШЕСТОГРАМИ

- H 1,5 mm
- H 2 mm
- H 2,5 mm
- H 3 mm
- H 4 mm
- H 5 mm
- H 6 mm
- H 8 mm
- H 10 mm



№	Характеристики	
18496		5

FESTA

КОМПЛЕКТ ШЕСТОГРАМИ С ОБЛА ГЛАВА

- H 1,5 mm
- H 2 mm
- H 2,5 mm
- H 3 mm
- H 4 mm
- H 5 mm
- H 6 mm
- H 8 mm
- H 10 mm



№	Характеристики	
18500		5

FESTA

КОМПЛЕКТ ШЕСТОГРАМИ, УДЪЛЖЕНИ

- H 1,5 mm
- H 2 mm
- H 2,5 mm
- H 3 mm
- H 4 mm
- H 5 mm
- H 6 mm
- H 8 mm
- H 10 mm



№	Характеристики	
18490		5

FESTA

КОМПЛЕКТ ШЕСТОГРАМИ С ОБЛА ГЛАВА

- H 1,5 mm
- H 2 mm
- H 2,5 mm
- H 3 mm
- H 4 mm
- H 5 mm
- H 6 mm
- H 8 mm
- H 10 mm



№	Характеристики	
18498		5

FESTA

КОМПЛЕКТ ШЕСТОГРАМИ С ОБЛА ГЛАВА

- 1/16"
- 5/64"
- 3/32"
- 1/8"
- 5/32"
- 3/16"
- 1/4"
- 5/16"
- 3/8"

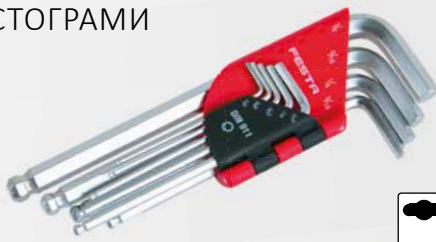

№	Характеристики	
18493		6

FESTA

КОМПЛЕКТ ШЕСТОГРАМИ, TORX

- T 10 mm
- T 15 mm
- T 20 mm
- T 25 mm
- T 27 mm
- T 30 mm
- T 40 mm
- T 45 mm
- T 50 mm



№	Характеристики	
18497		5

FESTA

КОМПЛЕКТ ШЕСТОГРАМИ С ОБЛА ГЛАВА, УДЪЛЖЕНИ

- H 1,5 mm
- H 2 mm
- H 2,5 mm
- H 3 mm
- H 4 mm
- H 5 mm
- H 6 mm
- H 8 mm
- H 10 mm



№	Характеристики	
18492		10

FESTA

КОМПЛЕКТ ШЕСТОГРАМИ, TORX, УДЪЛЖЕНИ

- T 10 mm
- T 15 mm
- T 20 mm
- T 25 mm
- T 27 mm
- T 30 mm
- T 40 mm
- T 45 mm
- T 50 mm



№	Характеристики	
18491		5

FESTA

ДЖОБЕН КОМПЛЕКТ ШЕСТОГРАМИ



R. s.	leírás	
18508	1,5 · 2 · 2,5 · 3 · 4 · 5 · 6 mm	1

ДЖОБЕН КОМПЛЕКТ ШЕСТОГРАМИ



№	Характеристики	
18499	2 · 2,5 · 3 · 4 · 5 · 6 · 8 · 10 mm	1

FESTA

ГАЕЧЕН КЛЮЧ, ОТВОРЕН, ДВУСТРАНЕН

CrV DIN 3110



№	Характеристики	
17550	6 x 7 mm	10
17551	8 x 9 mm	10
17552	8 x 10 mm	10
17553	10 x 11 mm	10
17590	10 x 13 mm	10
17554	12 x 13 mm	10
17555	14 x 15 mm	10
17556	13 x 16 mm	10
17557	13 x 17 mm	10
17591	14 x 17 mm	10
17558	16 x 17 mm	10
17559	17 x 19 mm	10
17560	18 x 19 mm	10

№	Характеристики	
17592	19 x 22 mm	10
17593	19 x 24 mm	10
17561	20 x 22 mm	10
17569	21 x 23 mm	10
17548	22 x 24 mm	10
17562	24 x 27 mm	10
17549	24 x 30 mm	10
17563	30 x 32 mm	10
17564	30 x 34 mm	10
17565	32 x 36 mm	10
17566	36 x 41 mm	10
17567	46 x 50 mm	10
17568	50 x 55 mm	3

FESTA

ГАЕЧЕН КЛЮЧ, ОТВОРЕН, ДВУСТРАНЕН

CrV DIN 3113



№	Характеристики	
17487	6 mm	10
17570	7 mm	10
17571	8 mm	10
17572	9 mm	10
17573	10 mm	10
17574	11 mm	10
17575	12 mm	10
17576	13 mm	10
17577	14 mm	10
17578	15 mm	10
17579	16 mm	10
17580	17 mm	10
17581	18 mm	10
17582	19 mm	10
17488	20 mm	10

№	Характеристики	
17489	21 mm	10
17583	22 mm	10
17490	23 mm	10
17584	24 mm	10
17491	25 mm	10
17492	26 mm	10
17585	27 mm	10
17493	28 mm	10
17494	29 mm	10
17586	30 mm	10
17587	32 mm	10
17495	33 mm	10
17496	34 mm	10
17589	36 mm	10

FESTA

КОМБИНИРАН КЛЮЧ, С ТРЕСЧОТКА И ШАРНИР

CrV 72T



№	Характеристики	
17628	8 mm	10
17622	10 mm	10
17623	13 mm	10
17624	14 mm	10
17629	15 mm	10
17630	16 mm	5

№	Характеристики	
17625	17 mm	10
17631	18 mm	10
17626	19 mm	10
17632	21 mm	5
17633	22 mm	5

FESTA

КОМБИНИРАН КЛЮЧ, С ТРЕСЧОТКА

CrV 72T



№	Характеристики	
17660	6 mm	10
17676	7 mm	10
17661	8 mm	10
17662	9 mm	10
17663	10 mm	10
17664	11 mm	10
17665	12 mm	10
17666	13 mm	10
17667	14 mm	10
17668	15 mm	10

№	Характеристики	
17669	16 mm	10
17670	17 mm	10
17671	18 mm	10
17672	19 mm	10
17674	21 mm	5
17675	22 mm	5
17677	24 mm	5
17678	27 mm	5
17679	30 mm	5
17683	32 mm	5

FESTA

ГАЕЧЕН КЛЮЧ, ОТВОРЕН, ДВУСТРАНЕН

DIN 895



№	Характеристики	
17460	6 x 7 mm	10
17461	8 x 9 mm	10
17462	8 x 10 mm	10
17463	10 x 11 mm	10
17481	10 x 13 mm	10
17464	12 x 13 mm	10
17465	14 x 15 mm	10
17467	13 x 17 mm	10
17482	14 x 17 mm	10
17468	16 x 17 mm	10

№	Характеристики	
17469	17 x 19 mm	10
17470	18 x 19 mm	10
17483	19 x 22 mm	10
17484	19 x 24 mm	10
17471	20 x 22 mm	10
17472	24 x 27 mm	10
17486	21 x 23 mm	10
17480	28 x 30 mm	10
17473	30 x 32 mm	10
17485	36 x 41 mm	10

FESTA

ГАЕЧЕН КЛЮЧ, ЗВЕЗДООБРАЗЕН, ЛУЛА

CrV DIN 838



№	Характеристики	
17605	6 x 7 mm	10
17606	8 x 9 mm	10
17607	8 x 10 mm	10
17608	10 x 11 mm	10
17609	12 x 13 mm	10
17611	13 x 16 mm	10
17612	13 x 17 mm	10

№	Характеристики	
17610	14 x 15 mm	10
17613	16 x 17 mm	10
17614	18 x 19 mm	10
17615	20 x 22 mm	10
17616	24 x 27 mm	10
17617	30 x 32 mm	10

FESTA

ГАЕЧЕН КЛЮЧ, ОТВОРЕН, ДВУСТРАНЕН

CrV DIN 3110



№	Характеристики	
17761	14 x 15 mm	10
17769	20 x 22 mm	10

№	Характеристики	
17788	14 mm	10
17795	21 mm	10
17806	33 mm	10

FESTA

ГАЕЧЕН КЛЮЧ, ОТВОРЕН, ДВУСТРАНЕН

CrV DIN 3113



FESTA

КЛЮЧ С ТРЕСЧОТКА
КОМПЛЕКТ

8-9-10-11-12-13-14-15-16-17-18-19 mm



№	Характеристики	
17619		1



NEW

FESTA

КЛЮЧ

Cr-Mo



12-13-14-15 mm

16-17-18-19 mm

№	Характеристики	
17685	12-13-14-15-16-17-18-19 mm	1



FESTA

РЕГУЛИРУЕМ ГАЕЧЕН КЛЮЧ

CrV



№	Характеристики	
17197	0 - 29 mm 200 mm	1
17198	0 - 33 mm 250 mm	1
17199	0 - 38 mm 300 mm	1



РЕГУЛИРУЕМ ГАЕЧЕН КЛЮЧ

№	Характеристики	
17200	0 - 24 mm 200 mm	6
17201	0 - 30 mm 250 mm	6
17202	0 - 34 mm 300 mm	6



FESTA



FESTA

КОМПЛЕКТ ОТВОРЕНИ
ГАЕЧНИ КЛЮЧОВЕ

CrV

DIN 3110



№	Характеристики	
17506	6 бр. · 6 x 7, 8 x 9, 10 x 11, 12 x 13, 14 x 15, 16 x 17	1
17508	8 бр. · 6 x 7, 8 x 9, 10 x 11, 12 x 13, 14 x 15, 16 x 17, 18 x 19, 20 x 22	1



FESTA

КОМПЛЕКТ КОМБИНИРАНИ
КЛЮЧОВЕ

CrV

DIN 3113



№	Характеристики	
17526	6 бр. · 10 x 10, 11 x 11, 13 x 13, 14 x 14, 16 x 16, 17 x 17	1
17528	8 бр. · 8 x 8, 10 x 10, 11 x 11, 13 x 13, 14 x 14, 16 x 16, 17 x 17, 19 x 19	1



FESTA

КОМПЛЕКТ КЛЮЧОВЕ,
ЗВЕЗДООБРАЗНИ, ЛУЛА

8x

CrV

DIN 838



№	Характеристики	
17539	6 x 7, 8 x 9, 10 x 11, 12 x 13, 14 x 15, 16 x 17, 18 x 19, 20 x 22	1



FESTA

КОМПЛЕКТ КОМБИНИРАНИ КЛЮЧОВЕ

CrV

DIN 3113



№	Характеристики	
17532	12 бр. · 8 x 8, 9 x 9, 10 x 10, 11 x 11, 13 x 13, 14 x 14, 16 x 16, 17 x 17, 18 x 18, 19 x 19, 21 x 21, 22 x 22	10
17533	18 бр. · 6 x 6, 7 x 7, 8 x 8, 9 x 9, 10 x 10, 11 x 11, 12 x 12, 13 x 13, 14 x 14, 15 x 15, 16 x 16, 17 x 17, 18 x 18, 19 x 19, 20 x 20, 21 x 21, 22 x 22, 24 x 24	1
17534	25 бр. · 6 x 6, 7 x 7, 8 x 8, 9 x 9, 10 x 10, 11 x 11, 12 x 12, 13 x 13, 14 x 14, 15 x 15, 16 x 16, 17 x 17, 18 x 18, 19 x 19, 20 x 20, 21 x 21, 22 x 22, 23 x 23, 24 x 24, 25 x 25, 26 x 26, 27 x 27, 28 x 28, 30 x 30, 32 x 32	4

FESTA

КОМПЛЕКТ КОМБИНИРАНИ КЛЮЧОВЕ, С ТРЕСЧОТКА

CrV



7x



№	Характеристики	
17620	8, 10, 12, 13, 14, 17, 19	5

FESTA

КОМПЛЕКТ КОМБИНИРАНИ КЛЮЧОВЕ, С ТРЕСЧОТКА И ШАРНИР

CrV



7x



№	Характеристики	
17621	10, 12, 13, 14, 15, 17, 19	5

FESTA

КОМПЛЕКТ ОТВОРЕНИ ГАЕЧНИ КЛЮЧОВЕ

CrV

DIN 3110

12x



№	Характеристики	
17512	6 x 7, 8 x 9, 10 x 11, 12 x 13, 14 x 15, 16 x 17, 18 x 19, 20 x 22, 21 x 23, 24 x 27, 25 x 28, 30 x 32	1

FESTA

КОМПЛЕКТ КЛЮЧОВЕ ЗА СВЕЩИ, ГЛУХИ, ЦИЛИНДРИЧНИ

CrV

7x



№	Характеристики	
17501	6 x 7, 8 x 9, 10 x 11, 12 x 13, 14 x 15, 16 x 17, 18 x 19	20
17640	Щифт за ключ · 135 mm	50

FESTA

КОМПЛЕКТ ОТВОРЕНИ ГАЕЧНИ КЛЮЧОВЕ

DIN 895



№	Характеристики	
17475	8 бр. · 6 x 7, 8 x 9, 10 x 11, 12 x 13, 14 x 15, 16 x 17, 18 x 19, 20 x 22	5
17476	12 бр. · 6 x 7, 8 x 9, 10 x 11, 12 x 13, 14 x 15, 16 x 17, 18 x 19, 20 x 22, 21 x 23, 24 x 27, 28 x 30, 30 x 32	3

FESTA

ГАЕЧЕН КЛЮЧ, ГЛУХ, ЦИЛИНДРИЧЕН, ЗА СВЕЩИ

CrV



№	Характеристики		№	Характеристики	
17650	6 x 7 mm	10	17655	16 x 17 mm	10
17651	8 x 9 mm	10	17645	16 x 18 mm	10
17642	8 x 10 mm	10	17653	16 x 21 mm	10
17652	10 x 11 mm	10	17656	18 x 19 mm	10
17643	12 x 13 mm	10	17657	19 x 22 mm	10
17654	14 x 15 mm	10	17659	22 x 24 mm	10
17644	14 x 17 mm	10	17658	24 x 27 mm	10

КЛЮЧ ЗА ЪГЛОШЛАЙФ, РЕГУЛИРУЕМ

№	Характеристики	
20967	200 mm	15



КЛЮЧ ЗА ЪГЛОШЛАЙФ

№	Характеристики	
20968	200 mm	1



FESTA

КЛЮЧ ЗА СКЕЛЕ
С ТРЕСЧОТКА



№	Характеристики	
17452	19 x 22 mm	2



FESTA

КЛЮЧ ЗА СКЕЛЕ
С ТРЕСЧОТКА

№	Характеристики	
17451	18 mm	10
17450	19 mm	10



FESTA

ДИНАМОМЕТРИЧЕН КЛЮЧ

№	Характеристики	
17203	1/4" 5 - 25 Nm	1
17204	1/2" 19 - 110 Nm	1
17205	1/2" 42 - 210 Nm	1
17206	3/4" 140 - 700 Nm	1



FESTA

made by **HENITON**

КОМПЛЕКТ
ДЪЛБОКИ ВЛОЖКИ

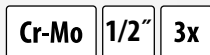

№	Характеристики	
17338	21 mm	5



КЛЮЧ ЗА ДЖАНТИ,
КРЪСТАТ



№	Характеристики	
17600	17, 19, 22 mm, 13/16"	16

КЛЮЧ ЗА ДЖАНТИ,
КРЪСТАТ



№	Характеристики	
17601	17, 19, 21 mm	20

ТЕЛЕСКОПИЧЕН
КЛЮЧ
ЗА ДЖАНТИ

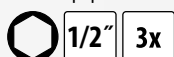

№	Характеристики	
17603	17 x 19 mm, 21 x 23 mm	20

КЛЮЧ,
Т-ОБРАЗЕН,
С ВЛОЖКА



№	Характеристики	
17261	16 mm	1
17262	21 mm	1

FESTA

СЕКТОРЕН КЛЮЧ,
РАЗДВИЖЕН, ЗА КРЪГЛИ ГАЙКИ

CrV



№	Характеристики		
17680	19 - 51 mm	165 mm	5
17681	32 - 76 mm	216 mm	5
17682	51 - 121 mm	267 mm	5

СКОБА ЗА ВАДЕНЕ
НА ЛАГЕРИ
С ДВЕ РАМЕНА



№	Макс. диаметър	Дълбочина	
23734	∅ 100 mm	50-95 mm	1
23735	∅ 150 mm	100-150 mm	1
23736	∅ 200 mm	110-190 mm	1

СКОБА ЗА ВАДЕНЕ
НА ЛАГЕРИ
С ТРИ РАМЕНА



№	Макс. диаметър	Дълбочина	
23730	∅ 100 mm	50-95 mm	2
23731	∅ 150 mm	100-150 mm	2
23732	∅ 200 mm	110-190 mm	2

FESTA

УНИВЕРСАЛЕН КЛЮЧ

CrV 1/2"

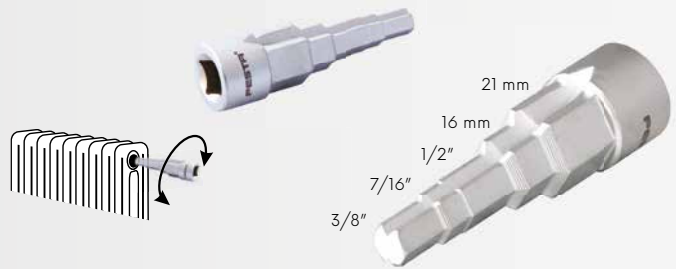

№	Характеристики	
17455		10

КЛЮЧЕ ЗА
ОБЕЗВЪЗДУШАВАНЕ

2x



№	Характеристики	
17454	5 x 5 mm	1

КЛЮЧЕ ЗА ОБЕЗВЪЗДУШАВАНЕ
С РЕЗЕРВОАР



№	Характеристики	
17459	50 ml	1



FESTA

УНИВЕРСАЛЕН КЛЮЧ

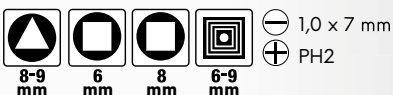

№	Характеристики	
17458		1



FESTA

УНИВЕРСАЛЕН КЛЮЧ

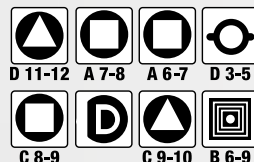

№	Характеристики	
17456		50





ERGONOMIC handle

STANDARD +30% FESTA

CrV · Хром-ванадиева стомана

HRC 58-62 · Твърдост на челюстите

ERGO HANDLE · Ергономична гумирана дръжка (TPE гума)

· Индуктивно втвърдени



КОМБИНИРАНИ КЛЕЦИ

DIN 5746	TUV GS	№	Характеристики	Icon
CrV	HRC 58-62	17101	160 mm	6
		17102	180 mm	6
		17103	200 mm	6



СТРАНИЧНИ КЛЕЦИ РЕЗАЧКИ

DIN 5749	TUV GS	CrV	HRC 58-62	ERGO HANDLE	№	Характеристики	Icon
					17148	180 mm	6



СТРАНИЧНИ КЛЕЦИ РЕЗАЧКИ

DIN 5749	TUV GS	CrV	HRC 58-62	ERGO HANDLE	№	Характеристики	Icon
					17104	160 mm	6
					17105	180 mm	6



ТЕЛЕФОННИ КЛЕЦИ С ПРАВИ ЧОВКИ

DIN 5745	TUV GS	CrV	HRC 58-62	ERGO HANDLE	№	Характеристики	Icon
					17140	160 mm	6
					17142	200 mm	6



ТЕЛЕФОННИ КЛЕЦИ С КРИВИ ЧОВКИ

DIN 5749	TUV GS	CrV	HRC 58-62	ERGO HANDLE	№	Характеристики	Icon
					17145	160 mm	6
					17146	200 mm	6



FESTA





FESTA

КОМБИНИРАНИ КЛЕЩИ

DIN 5746				
№	Характеристики			
17001	160 mm			6
17002	180 mm			6
17003	200 mm			6



FESTA

СТРАНИЧНИ КЛЕЩИ РЕЗАЧКИ

DIN 5749				
№	Характеристики			
17004	160 mm			6
17005	180 mm			6



FESTA

СТРАНИЧНИ КЛЕЩИ РЕЗАЧКИ

DIN 5749				
№	Характеристики			
17108	180 mm			6



FESTA

ЧЕЛНИ КЛЕЩИ РЕЗАЧКИ

DIN 5748				
№	Характеристики			
17110	160 mm			6



FESTA

ТЕЛЕФОННИ КЛЕЩИ
С ПРАВИ ЧОВКИ

DIN 5745				
№	Характеристики			
17006	160 mm			6
17011	200 mm			6



FESTA

ТЕЛЕФОННИ КЛЕЩИ С
КРИВИ ЧОВКИ

DIN 5745				
№	Характеристики			
17007	160 mm			6
17008	200 mm			6



FESTA

КЛЕЩИ С ПЛОСКИ ЧЕЛЮСТИ

DIN 5746				
№	Характеристики			
17009	160 mm			6



FESTA

КЛЕЩИ ЗЕГЕР

DIN 5745			
№	Характеристики		
17010	160 mm		6



FESTA

КЛЕЩИ ЗА ПРОВОДНИЦИ

DIN 5744			
№	Характеристики		
17024	160 mm		6



КОМБИНИРАНИ КЛЕЩИ

DIN 5746		
№	Характеристики	
17094	160 mm	6
17095	180 mm	6
17096	200 mm	6



СТРАНИЧНИ КЛЕЩИ РЕЗАЧКИ

DIN 5749		
№	Характеристики	
17097	160 mm	6
17098	180 mm	6



ТЕЛЕФОННИ КЛЕЩИ
С ПРАВИ ЧОВКИ

DIN 5745		
№	Характеристики	
17099	160 mm	6
17100	200 mm	6



VDE КОМБИНИРАНИ КЛЕЩИ

1000 V IEC/EN60900:2004 DIN 5746 CrV HRC 58-62

№	Характеристики	
17125	160 mm	6
17126	180 mm	6
17127	200 mm	6



VDE СТРАНИЧНИ КЛЕЩИ РЕЗАЧКИ

1000 V IEC/EN60900:2004

DIN 5749 CrV HRC 58-62

№	Характеристики	
17128	160 mm	6



VDE КЛЕЩИ ЗА РЯЗАНЕ НА ПРОВОДНИЦИ

1000 V IEC/EN60900:2004

CrV HRC 58-62

№	Характеристики	
17130	160 mm	6



VDE ТЕЛЕФОННИ КЛЕЩИ С ПРАВИ ЧОВКИ

1000 V IEC/EN60900:2004

DIN 5745 CrV HRC 58-62

№	Характеристики	
17133	160 mm	6



VDE ТЕЛЕФОННИ КЛЕЩИ С КРИВИ ЧОВКИ

1000 V IEC/EN60900:2004

DIN 5745 CrV HRC 58-62

№	Характеристики	
17135	160 mm	6



VDE ЗЕГЕР КЛЕЩИ

1000 V IEC/EN60900:2004

DIN 5745 CrV HRC 58-62

№	Характеристики	
17137	160 mm	6



VDE КЛЕЩИ ЗА ПРОВОДНИЦИ

1000 V IEC/EN60900:2004 CrV DIN 5744

№	Характеристики	
17138	160 mm	6



МИНИ КЛЕЩИ РЕЗАЧКИ, СТРАНИЧНИ

max Ø 0,2 - 2,1 mm

CrV

№	Характеристики	
17047	140 mm	10



МИНИ КЛЕЩИ РЕЗАЧКИ, СТРАНИЧНИ

0,75; 1,0; 1,5; 2,5; 4,0; 6,0mm²

CrV

№	Характеристики	
17087	145 mm	1



АВТОМАТИЧНИ КЛЕЩИ ЗА СВАЛЯНЕ НА ИЗОЛАЦИЯ

0,5 - 6 mm² 190 mm

№	Характеристики	
17178		1



АВТОМАТИЧНИ КЛЕЩИ ЗА СВАЛЯНЕ НА ИЗОЛАЦИЯ

№	Характеристики	
17180	Ø 0,75 - 2,5 mm	12



НОЖИЦА ЗА КАБЕЛИ

№	Характеристики	
17181	Ø 0,60 - 2,6 mm	10

NEW



FESTA

СТРИПЕР ЗА КАБЕЛИ

AWG	mm ²
10	6,0
12	4,0
14	2,5
16	1,5
18	1,0
20	0,5

- Коаксиален кабел RG6/59
- нисковолтов кабел Ø 8- 13 мм

FESTA

СТРИПЕР ЗА КАБЕЛИ

· Ø 0,2-4 mm

№	Характеристики	
16205	125 mm	1

№	Характеристики	
16202	125 mm	10



- AWG 22-18/16-14/12-10
- DIN 0,5-1,0/1,5-2,5/4-6mm²

- AWG 20-16/16-14/12-10/8
- DIN 0,5-1,0/1,5-2,5/4-6/10mm²

- AWG 20-18/16-14/12-10
- DIN 0,5-1,0/1,5-2,5/4-6mm²

- AWG 20/18/17/16/14/12
- DIN 0,5/0,75/1,0/1,5/2,5/4,0mm²

- AWG 10/8/6
- DIN 6/10/16mm²

FESTA
INDUSTRY

КЛЕЩИ ЗА КРИМПВАНЕ

№	Характеристики	
18445		1

NEW



FESTA
INDUSTRY

КЛЕЩИ ЗА КРИМПВАНЕ

№	Характеристики	
16206		1



- AWG 10-22
- 0,5-0,6mm²

- AWG 10-22
- 0,5-0,6mm²

- AWG 10-22
- 0,5-0,6mm²

- оголване
- AWG 10-24
- 0,2-0,6mm²

NEW



FESTA
INDUSTRY

КЛЕЩИ ЗА КРИМПВАНЕ

№	Характеристики	
16208		1



- 1,5; 2,5; 6,0mm²

- 1,5; 2,5; 6,0mm²

- оголване
- 0,75; 1,0; 1,5; 2,5; 4,0; 6,0mm²

- нарязане
- M2,6; M3; M3,5; M4; M5

NEW



FESTA

МНОГОФУНКЦИОНАЛНИ КЛЕЩИ

- 9 инструмента
- Калъф



№	Характеристики	
16232		12



FESTA

КОМПЛЕКТ МИНИ КЛЕЩИ

4x

№	Характеристики	
17040		6



FESTA

МИНИ КОМБИНИРАНИ КЛЕЩИ

№	Характеристики	
17041	110 mm	12



FESTA

МИНИ КЛЕЩИ РЕЗАЧКИ, СТРАНИЧНИ

№	Характеристики	
17042	110 mm	12



FESTA

МИНИ КЛЕЩИ РЕЗАЧКИ, ЧЕЛНИ

№	Характеристики	
17043	100 mm	12



FESTA

МИНИ КЛЕЩИ РЕЗАЧКИ С ДЪЛГА ЧОВКА

№	Характеристики	
17044	120 mm	12



FESTA

МИНИ ЗЕГЕР КЛЕЩИ

№	Характеристики	
17045	120 mm	12



МНОГОФУНКЦИОНАЛНИ ЗЕГЕР КЛЕЩИ

№	Характеристики	
17025	Комплект	10



FESTA

ЗЕГЕР КЛЕЩИ ЗА ПРЪСТЕНИ

№	Характеристики	
17190	180 mm външни	6
17191	180 mm вътрешни	6



FESTA

ЗЕГЕР КЛЕЩИ ЗА ПРЪСТЕНИ

№	Характеристики	
17192	180 mm външни	15
17193	180 mm вътрешни	15



FESTA

**МНОГОФУНКЦИОНАЛНИ
КЛЕЩИ**

· За ограда

CrV



№	Характеристики	
17109	270 mm	4



КЛЕЩИ ЧИРАЦИ, ЗАВАРЪЧНИ

№	Характеристики	
17150	220 mm	1



КЛЕЩИ ЧИРАЦИ, ЗАВАРЪЧНИ

№	Характеристики	
17151	225 mm	1



КЛЕЩИ ЧИРАЦИ, ЗАВАРЪЧНИ

№	Характеристики	
17034	220 mm	5

max. 70mm



FESTA

КЛЕЩИ ЧИРАЦИ, ЗАВАРЪЧНИ

№	Характеристики	
17036	270 mm	5



КЛЕЩИ ЧИРАЦИ, ЗАВАРЪЧНИ

№	Характеристики	
17035	220 mm	10



FESTA

КЛЕЩИ ЧИРАЦИ, ЗАВАРЪЧНИ

№	Характеристики	
17023	220 mm	6

FESTA

ВОДОПРОВОДЕН КЛЮЧ 45°, S

CrV



№	Характеристики	
17067	1" 330 mm	1
17068	1,5" 420 mm	1
17069	2" 540 mm	1



FESTA

**РЕГУЛИРУЕМ
ВОДОПРОВОДЕН КЛЮЧ**

CrV

№	Характеристики	
17063	230 mm	6
17064	300 mm	6

FESTA

КЛЮЧ ЗА ТРЪБИ 90°

CrV



№	Характеристики	
17075	1" 330 mm	1
17076	1,5" 420 mm	1
17077	2" 540 mm	1



ВОДОПРОВОДЕН КЛЮЧ

FESTA

ВОДОПРОВОДЕН КЛЮЧ 90°

CrV



№	Характеристики	
17070	2,5" 355 mm	12
17071	3" 455 mm	8
17072	3,5" 610 mm	10



№	Характеристики	
17065	260 mm	36
17066	300 mm	36

FESTA

ВОДОПРОВОДНИ КЛЕЩИ



CrV

№	Характеристики	Размер на челюстите	Кол. в опаковка
16500	180 mm	0 - 40 mm	1
16501	250 mm	0 - 52 mm	1
16502	300 mm	0 - 68 mm	1

FESTA

РЕГУЛИРУЕМИ ВОДОПРОВОДНИ КЛЕЩИ



CrV

№	Характеристики	Размер на челюстите	Кол. в опаковка
17059	180 mm	0 - 30 mm	6
17061	250 mm	0 - 30 mm	6
17062	300 mm	0 - 40 mm	6
17080	400 mm	0 - 84 mm	4

FESTA

РЕГУЛИРУЕМИ ВОДОПРОВОДНИ КЛЕЩИ



CrV

№	Характеристики	Размер на челюстите	Кол. в опаковка
17084	250 mm	0 - 30 mm	6

FESTA

ВОДОПРОВОДНИ КЛЕЩИ



CrV

· large range of jaws

№	Характеристики	Размер на челюстите	Кол. в опаковка
17086	250 mm	0 - 50 mm	6

FESTA

ВОДОПРОВОДНИ КЛЕЩИ



CrV

№	Характеристики	Размер на челюстите	Кол. в опаковка
17081	180 mm	0 - 30 mm	6
17014	250 mm	0 - 30 mm	6
17082	300 mm	0 - 50 mm	6

FESTA

РЕГУЛИРУЕМИ ВОДОПРОВОДНИ КЛЕЩИ



CrV

№	Характеристики	Размер на челюстите	Кол. в опаковка
17079	250 mm	0 - 50 mm	6

FESTA

ВОДОПРОВОДНИ КЛЕЩИ



CrV

№	Характеристики	Размер на челюстите	Кол. в опаковка
17012	250 mm	0 - 40 mm	6
17060	300 mm	0 - 50 mm	10

FESTA

ВОДОПРОВОДНИ КЛЕЩИ



CrV

№	Характеристики	Размер на челюстите	Кол. в опаковка
17013	250 mm	0 - 30 mm	6
17033	300 mm	0 - 50 mm	6

ПЛАСТМАСОВ ПРОТЕКТОР ЗА ЧЕЛЮСТИ



· Подходящ за 17061, 17079

№	Характеристики	Кол. в опаковка
17085	1 двойка	1

FESTA

КЛЕЩИ ЗА СТОМАНЕНИ ВЪЖЕТА И ПРОВОЛКИ

- Стоманени въжета
- ACSR кабели
- Кабелни обувки

CrV

max. Ø 6 mm

С.р.	спецификация	Кол. в опаковка
17029	200 mm	6

FESTA

НОЖИЦИ ЗА СТОМАНЕНИ ВЪЖЕТА

- Стоманени въжета
- ACSR кабели
- Кабелни обувки

CrV

max. Ø 12 mm

С.р.	спецификация	Кол. в опаковка
17039	24' 610 mm	8



FESTA

НОЖИЦА ЗА АРМАТУРА И СТОМАНЕНИ ВЪЖЕТА

Cr-Mo



№	Характеристики		
17049	18' 450 mm	max. 6 mm < 40 HRC	1

FESTA

АРМАТУРНА НОЖИЦА, PROFİ

Cr-Mo

HRC 58-62



№	Характеристики	max. Ø дрáту	
17051	14' 350 mm	max. 5 mm < 45 HRC	1
17052	18' 450 mm	max. 6 mm < 45 HRC	1
17053	24' 610 mm	max. 8 mm < 45 HRC	1
17054	30' 760 mm	max. 10 mm < 45 HRC	1
17048	36' 900 mm	max. 12 mm < 45 HRC	1



FESTA

НОЖИЦА ЗА АРМАТУРА И СТОМАНЕНИ ВЪЖЕТА

· За арматура и стоманени въжета

Cr-Mo

HRC 58-62



№	Характеристики	max. Ø дрáту	max. Ø ланка	max. Ø кабелу	
17055	14' 360 mm	max. 5 mm < 45 HRC	max. 3,5 mm	max. 8 mm	1
17056	18' 460 mm	max. 6 mm < 45 HRC	max. 5 mm	max. 10 mm	1
17057	24' 610 mm	max. 8 mm < 45 HRC	max. 7 mm	max. 12 mm	1
17058	30' 760 mm	max. 10 mm < 45 HRC	max. 9 mm	max. 14 mm	1
17046	35' 900 mm	max. 12 mm < 45 HRC	max. 10 mm	max. 16 mm	1



FESTA

АРМАТУРНА НОЖИЦА

Cr-Mo

HRC 57-62

max. Ø
4 mm



№	Характеристики		
17038	8' 210 mm	max. 4 mm < 30 HRC	10



FESTA

АРМАТУРНА НОЖИЦА

- мека тел: Ø 6 mm
- средно твърда тел: Ø 5 mm
- твърда тел: Ø 4 mm

CrV



№	Характеристики		
17078	200 mm		12



АРМАТУРНА НОЖИЦА



№	Характеристики	max. Ø дрáту	
17028	14' 350 mm	max. 5 mm < 30 HRC	30
17020	18' 450 mm	max. 6 mm < 30 HRC	6
17021	24' 610 mm	max. 8 mm < 30 HRC	10
17022	30' 760 mm	max. 10 mm < 30 HRC	5

NEW



FESTA

АРМАТУРНИ КЛЕЩИ, ЧЕЛНИ

CrV HRC 58-62

№	Характеристики	
17172	200 mm	1



FESTA

КЛЕЩИ КЕРПЕДЕН, ЧЕЛНИ

CrV

№	Характеристики	
17300	160 mm	1
17301	180 mm	10
17302	200 mm	6
17303	250 mm	1



FESTA

АРМАТУРНИ КЛЕЩИ, ЧЕЛНИ

CrV

№	Характеристики	
17305	220 mm	5
17306	250 mm	1
17304	275 mm	6



КЛЕЩИ КЕРПЕДЕН, ЧЕЛНИ

№	Характеристики	
17015	160 mm	6
17016	180 mm	6
17017	200 mm	6



АРМАТУРНИ КЛЕЩИ, ЧЕЛНИ

№	Характеристики	
17019	220 mm	6
17083	275 mm	6



FESTA

ТЕНЕКЕДЖИЙСКИ КЛЕЩИ, ПРАВИ

№	Характеристики	
17089	150 x 215 mm	2

NEW



FESTA

ТЕНЕКЕДЖИЙСКИ КЛЕЩИ, ПРАВИ

№	Характеристики	
17341	24 x 180 mm	1

NEW



FESTA

ТЕНЕКЕДЖИЙСКИ КЛЕЩИ 45°

№	Характеристики	
17342	24 x 180 mm	1



FESTA

ТЕНЕКЕДЖИЙСКИ КЛЕЩИ, ПРАВИ

№	Характеристики	
17093	95 x 270 mm	6



FESTA

ТЕНЕКЕДЖИЙСКИ КЛЕЩИ 45°

№	Характеристики	
17091	50 x 280 mm	10



FESTA

ТЕНЕКЕДЖИЙСКИ КЛЕЩИ 90°

№	Характеристики	
17092	50 x 260 mm	10



FESTA

ТЕНЕКЕДЖИЙСКИ КЛЕЩИ, ПРАВИ

№	Характеристики	
17090	50 x 280 mm	10

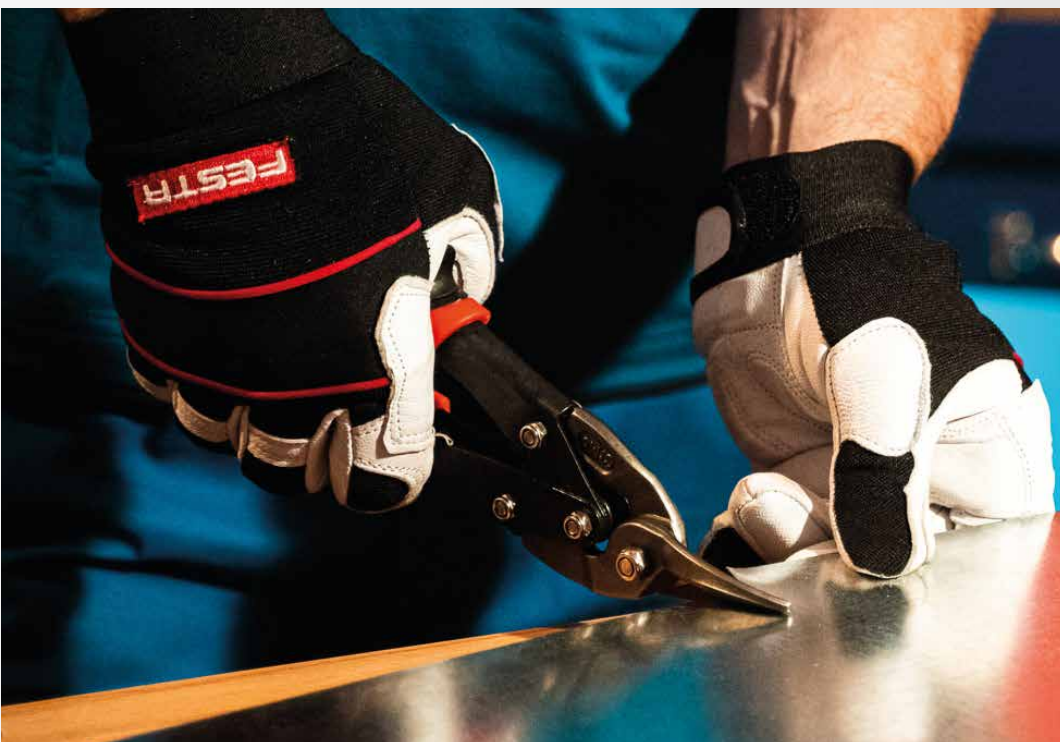

FESTA

НОЖИЦИ ЗА РЯЗАНЕ НА ЛАМАРИНА

CrV



№	Характеристики	
17170	50 250 mm	6



НОЖИЦИ ЗА РЯЗАНЕ НА ЛАМАРИНА

CrV



№	Характеристики	
17167	70 300 mm	5



НОЖИЦИ ЗА РЯЗАНЕ НА ЛАМАРИНА

CrV



№	Характеристики	
17165	60 250 mm	5



НОЖИЦИ ЗА РЯЗАНЕ НА ЛАМАРИНА

CrV



№	Характеристики	
17169	35 250 mm	5

FESTA

НОЖИЦИ ЗА РЯЗАНЕ НА ЛАМАРИНА УДЪЛЖЕН



Cr-Mo HRC 58-62

№	Характеристики	
17113	Прави 80 300 mm	6

FESTA

НОЖИЦИ ЗА РЯЗАНЕ НА ЛАМАРИНА

Cr-Mo HRC 58-62



№	Характеристики	
17111	Прави 40 250 mm	6
17116	Десни 40 250 mm	6
17121	Леви 40 250 mm	6

FESTA

НОЖИЦА ЗА ЛАМАРИНА

Cr-Mo HRC 58-62



№	Характеристики	
17112	Прави 40 260 mm	6
17117	Десни 40 260 mm	6
17122	Леви 40 260 mm	6



**ЩАНЦОВА НОЖИЦА
ЗА РЯЗАНЕ
НА ЛАМАРИНА**



№	Характеристики	
20364		1



**НОЖИЦИ ЗА РЯЗАНЕ
НА ЛАМАРИНА**

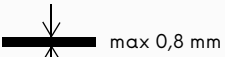

№	Характеристики	
17186	265 mm	6



860 mm

ЛОСТОВИ НОЖИЦИ



**ЩАНЦОВА НОЖИЦА ЗА РЯЗАНЕ
НА ЛАМАРИНА - ПРИСТАВКА**

Макс. дебелина на листа

- 1,8 mm- Стомана
- 1,2 mm- Неръждаема стомана
- 2 mm- Пластмаса, алуминий, мед

№	Характеристики	
20363		5

	17175	17177
	Max. 4 mm	5 mm
	Max. \varnothing 10 mm	\varnothing 12 mm
	Max. 8x8 mm	10x10 mm

№	Характеристики	
17175	150 mm	1
17177	250 mm	1

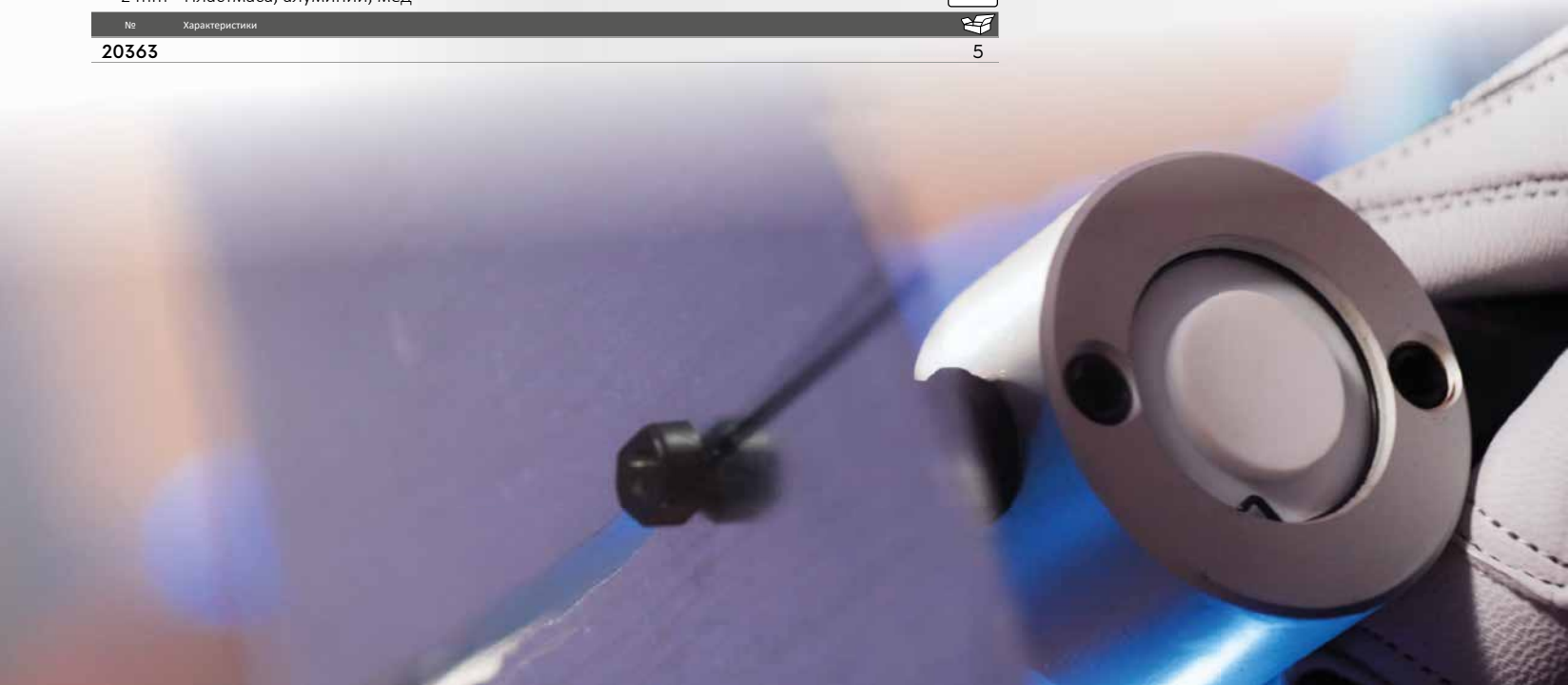



ТЕХНИЧЕСКИ НОЖИЦИ

INOX



№	Характеристики	Кол.
16420	60 200 mm	12



ТЕХНИЧЕСКИ НОЖИЦИ

INOX



№	Характеристики	Кол.
17159	65 220 mm	12



ТЕХНИЧЕСКИ НОЖИЦИ

INOX



№	Характеристики	Кол.
17158	50 150 mm	10



ТЕХНИЧЕСКИ НОЖИЦИ

INOX



№	Характеристики	Кол.
17160	70 210 mm	12



НОЖИЦИ

INOX

№	Характеристики	Кол.
16405	14 cm	24
16406	17 cm	24
16407	19 cm	24
16408	21,5 cm	12



НОЖИЦИ

3x INOX

№	Характеристики	Кол.
16401	3 ks	48



FESTA

РЕВОЛВЕРНИ КЛЕЩИ ЗАМБИ (ЗА ПРОБИВАНЕ)

№	Характеристики	Кол.
17185	Ø 2; 2,5; 3; 3,5; 4; 4,5 mm	12



FESTA

КЛЕЩИ ЗА ПРОФИЛИ

• За цокли, тръби и профили

№	Характеристики	Кол.
17050	60 250 mm ø 17 mm, ø 20 mm, ø 27 mm	8



КЛЕЩИ ЗА СВЪРЗВАНЕ НА ПРОФИЛИ

№	Характеристики	Кол.
17187	350 mm	6



КЛЕЩИ ЗА СВЪРЗВАНЕ НА ПРОФИЛИ, ПЕРФОРИРАЩИ

№	Характеристики	Кол.
17188	250 mm	12



КЛЕЩИ ЗА ДЮБЕЛИ

№	Характеристики	Кол.
17189	255 mm	12





FESTO

FESTO

КЛЕЩИ
НИТАЧКИ

Cr-Mo

- Ø 2,4 mm
- Ø 3,2 mm
- Ø 4,0 mm
- Ø 4,8 mm



№	Характеристики
24007	200 mm



1



FESTO

КЛЕЩИ
НИТАЧКИ

Cr-Mo

- Ø 2,4 mm
- Ø 3,2 mm
- Ø 4,0 mm
- Ø 4,8 mm



№	Характеристики
24010	250 mm



12



FESTO

КЛЕЩИ НИТАЧКИ

Cr-Mo

- Ø 2,4 mm
- Ø 3,2 mm
- Ø 4,0 mm
- Ø 4,8 mm
- Ø 6,4 mm



№	Характеристики
24017	280 mm



1



FESTO

КЛЕЩИ НИТАЧКИ

Cr-Mo

- Ø 2,4 mm
- Ø 3,2 mm
- Ø 4,0 mm
- Ø 4,8 mm
- Ø 6,4 mm



№	Характеристики
24015	530 mm



1



FESTO

КЛЕЩИ НИТАЧКИ

Cr-Mo

- Ø 2,4 mm
- Ø 3,2 mm
- Ø 4,0 mm
- Ø 4,8 mm



№	Характеристики
24030	255 mm



24



FESTO

КЛЕЩИ
НИТАЧКИ
С ВЪРЛЯЩА
СЕ ГЛАВА

Cr-Mo

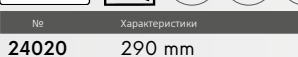

№	Характеристики
24020	290 mm



8





КЛЕЩИ НИТАЧКИ



№	Характеристики	Кол-во
24001	260 mm	6

КЛЕЩИ НИТАЧКИ С НИТОВЕ

Cr-Mo

- Ø 2,4 x 6 mm
- Ø 3,2 x 6 mm
- Ø 4,0 x 6 mm
- Ø 4,8 x 6 mm



№	Характеристики	Кол-во
24005	260 mm	5

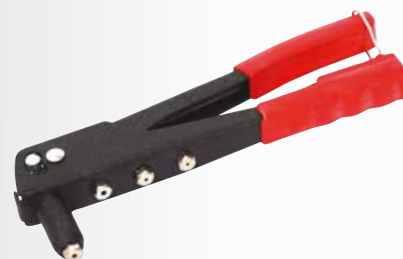

КЛЕЩИ НИТАЧКИ



№	Характеристики	Кол-во
24000	240 mm	24

FESTA

ПРИСТАВКА
ЗА НИТОВАНЕ
ЗА БОРМАШИНА

- Ø 2,4 mm
- Ø 3,2 mm
- Ø 4,0 mm
- Ø 4,8 mm



Cr-Mo

№	Характеристики	Кол-во
24008		1



КОМПЛЕКТ НИТОВЕ, АЛУМИНИЙ

ALU

50x

№	Характеристики	Кол-во
23970	3,2 x 6 mm	25
23971	3,2 x 8 mm	25
23972	3,2 x 10 mm	25
23973	3,2 x 12 mm	25
23974	3,2 x 14 mm	25
23975	4,0 x 6 mm	25
23976	4,0 x 8 mm	25
23977	4,0 x 10 mm	25
23978	4,0 x 12 mm	25
23979	4,0 x 14 mm	25
23985	4,8 x 6 mm	25
23986	4,8 x 8 mm	25
23987	4,8 x 10 mm	25
23988	4,8 x 12 mm	25
23989	4,8 x 14 mm	25



FESTA

НИТАЧКИ
ЗА НИТ ГАЙКИ

Cr-Mo

- M3
- M4
- M5
- M6
- M8
- M10



№	Характеристики	Кол-во
24036	330 mm	1



FESTA

ГЛАВА ЗА НИТАЧКА ЗА НИТ ГАЙКИ

Подходяща за 24035, 24036

Cr-Mo

№	Характеристики	Кол-во
24038	M3	1
24039	M4	1
24040	M5	1
24041	M6	1
24042	M8	1
24043	M10	1



FESTA

НИТАЧКИ
ЗА НИТ ГАЙКИ

Cr-Mo

- M3
- M4
- M5
- M6



№	Характеристики	Кол-во
24035	200 mm	1



НИТ-ГАЙКИ

ALU





20x

№	Характеристики	Кол-во
23950	M3 x 9 mm	20
23951	M4 x 11 mm	20
23952	M5 x 12 mm	50
23953	M6 x 14 mm	50
23954	M8 x 16,5 mm	25
23955	M10 x 18 mm	20



FESTA

ТАКЕР

-  | 6 - 14 mm
23960 - 23964
-  | 10 - 14 mm
23965
-  | 15 mm
23966
-  | 15 mm
23967







№ 23927 Характеристики

6

FESTA

ТАКЕР

-  | 6 - 14 mm
23960 - 23964
-  | 12 mm
23965
-  | 14 mm
23966
-  | 14 mm
23967





№ 23924 Характеристики

12

FESTA

ТАКЕР

-  | 6 - 14 mm
23960 - 23964
-  | 14 mm
23966
-  | 14 mm
23967



№ 23923 Характеристики

12



FESTA

ТАКЕР

-  53 | 4 - 14 mm
23904 - 23914,
23760 - 23765

№ 23925 Характеристики 4 - 14 mm със заключване 20



ТАКЕР

-  53 | 4 - 14 mm
23760 - 23765,
23904 - 23914

№ 23800 Характеристики 20



ТАКЕР



-  | 0,7 mm
 $\alpha=9-11\text{ mm}, b=5,5\text{ mm}, c=6,4\text{ mm}$

№ 23920 Характеристики 4



FESTA

ТАКЕР ЧУК

-  | 6 - 10 mm
23960 - 23962

№ 23922 Характеристики 10



ТАКЕР ЧУК

-  | 6 - 10 mm
23960 - 23962

№ 23928 Характеристики 6



FESTA

УРЕД ЗА ПРЕМАХВАНЕ НА СКОБИ

№ 23945 Характеристики 25

FESTA

СТЯГА EXTRA



№	Характеристики	
23960	b=6 mm, 1000 бр.	50
23961	b=8 mm, 1000 бр.	50
23962	b=10 mm, 1000 бр.	50
23963	b=12 mm, 1000 бр.	50
23964	b=14 mm, 1000 бр.	50

FESTA

СТЯГА

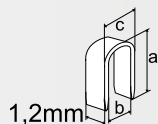

№	Характеристики	
23965	a=12 mm, b=6,5 mm, c=7,5 mm, 1000 TW	50

СТЯГА (ТИП 53)

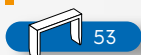

№	Характеристики	
23904	b=4 mm 1000 бр.	200
23906	b=6 mm 1000 бр.	200
23908	b=8 mm 1000 бр.	200
23910	b=10 mm 1000 бр.	200
23912	b=12 mm 1000 бр.	200
23914	b=14 mm 1000 бр.	200

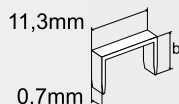

FESTA

ПИРОНИ



№	Характеристики	
23966	14 mm 1000 TW	100

FESTA

ПИРОНИ



№	Характеристики	
23967	14 mm 1000 TW	100

СТЯГА (ТИП 53)



№	Характеристики	
23760	b=4 mm 2000 бр.	10
23761	b=6 mm 2000 бр.	10
23762	b=8 mm 2000 бр.	10
23763	b=10 mm 2000 бр.	10
23764	b=12 mm 2000 бр.	10

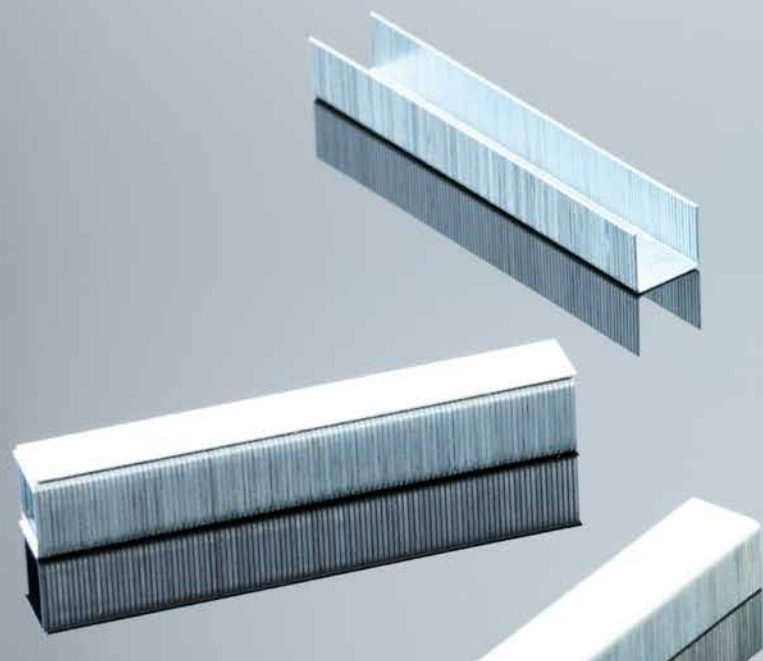
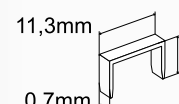

FESTA



FESTA

ТЕЛЕНА ЧЕТКА
С ПЛАСТ-
МАСОВА ДРЪЖКА



№	Характеристики	реда	
22080	270 mm	5 реда	12

FESTA

ТЕЛЕНА ЧЕТКА,
МЕСИНГ



№	Характеристики	реда	
22082	270 mm	5 реда	12

FESTA

КОМПЛЕКТ
ТЕЛЕНИ
ЧЕТКИ,
СТОМАНЕНА ТЕЛ



· Найлон, неръждаема стомана, месинг

3x



№	Характеристики	реда	
22086	180 mm		12

КОМПЛЕКТ
ТЕЛЕНИ
ЧЕТКИ,
СТОМАНЕНА ТЕЛ



3x



№	реда	
22081	3 реда	12



22158



22159

ТЕЛЕНА ЧЕТКА

№	Характеристики	Тел	
22158	200 mm	Стомана	36
22159	200 mm	месинг	36



22035



22036

ТЕЛЕНА ЧЕТКА С ПЛАСТМАСОВА ДРЪЖКА

№	Характеристики	Тел	
22035	270 mm	Стомана	24
22036	270 mm	Неръждаема стомана	24



ТЕЛЕНА ЧЕТКА С ДЪРВЕНА
ДРЪЖКА

№	Характеристики	реда	
22033	300 mm	4 реда	12
22034	300 mm	5 реда	12



ТЕЛЕНА ЧЕТКА С МЕСИНГОВО
ПОКРИТИЕ

№	реда	
22078	3 реда	20



ТЕЛЕНА ЧЕТКА С МЕСИНГОВО
ПОКРИТИЕ

№	Характеристики	реда	
22079	300 mm	4 реда	6

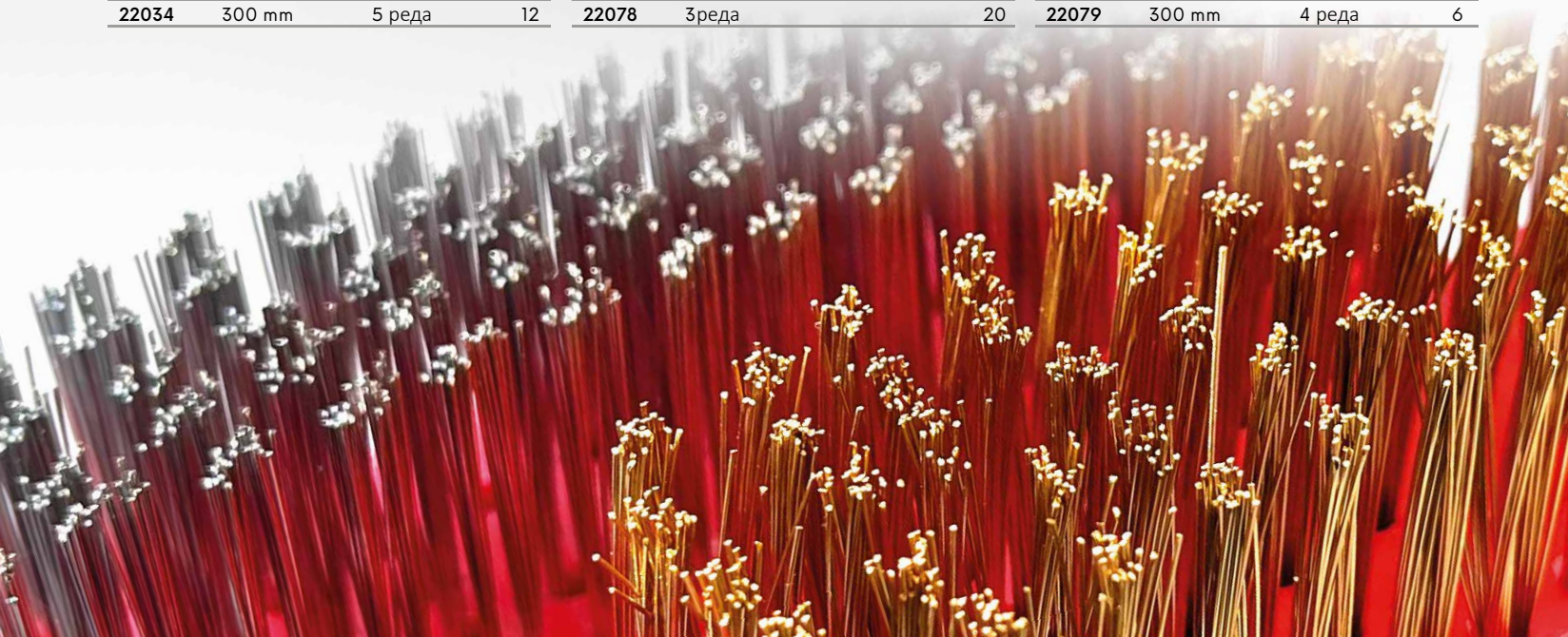

FESTA



FESTA

ПЛОСКА ПИЛА ЗА МЕТАЛ



№	Характеристики	Гравовост	
22206	150 mm	2	10
22180	250 mm	2	10



FESTA

ПОЛУКРЪГЛА ПИЛА ЗА МЕТАЛ



№	Характеристики	Гравовост	
22207	150 mm	2	10
22182	250 mm	2	10



FESTA

КВАДРАТНА ПИЛА ЗА МЕТАЛ



№	Характеристики	Гравовост	
22184	250 mm	2	10



FESTA

ТРИЪГЪЛНА ПИЛА ЗА МЕТАЛ



№	Характеристики	Гравовост	
22183	250 mm	2	10



FESTA

КРЪГЛА ПИЛА ЗА МЕТАЛ



№	Характеристики	Гравовост	
22181	250 mm	2	10



FESTA

ТРАПЕЦОВИДНА ПИЛА ЗА МЕТАЛ



№	Характеристики	Гравовост	
22178	150 mm	1	10

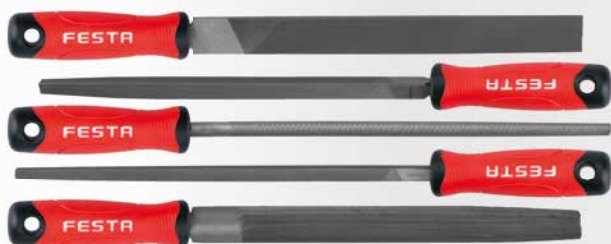

FESTA

КОМПЛЕКТ ПИЛИ ЗА МЕТАЛ



№	Характеристики	Гравовост	
22209	150 mm	2	10
22186	250 mm	2	5

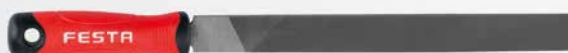

FESTA

КОМПЛЕКТ ПИЛИ ЗА МЕТАЛ



№	Характеристики	Гравовост	
22208	150 mm	2	10
22185	250 mm	2	5



FESTA

ПИЛА ЗА ЗАТОЧВАНЕ НА ВЕРИГИ



№	Характеристики	Упаковка	№	Характеристики	Упаковка
22170	200 mm 3,5 mm	10	22173	200 mm 5 mm	10
22171	200 mm 4 mm	10	22174	200 mm 5,5 mm	10
22172	200 mm 4,5 mm	10			



Ø 4 mm

FESTA

КОМПЛ. ЗА ЗАТОЧВАНЕ НА ВЕРИГА (ЗА РЕЗАЧКА)



№	Характеристики	Упаковка
22190	300 mm	5



FESTA

КОМПЛЕКТ ПРЕЦИЗНИ ПИЛИ



10x	№	Характеристики	Упаковка
	22188		20



FESTA

КОМПЛЕКТ ПРЕЦИЗНИ ПИЛИ С ДИАМАНТЕНО ПОКРИТИЕ



10x	№	Характеристики	Упаковка
	22189		25



FESTA

ПЛОСКА ПИЛА ЗА ДЪРВО



№	Характеристики	Упаковка
22202	150 mm	10
22197	300 mm	10



FESTA

КОМПЛЕКТ ПИЛИ ЗА ДЪРВО



3x	№	Характеристики	Упаковка
	22196	250 mm	5



FESTA

ПОЛУКРЪГЛА ПИЛА ЗА ДЪРВО



№	Характеристики	Упаковка
22203	150 mm	6
22199	300 mm	6



FESTA

КРЪГЛА ПИЛА ЗА ДЪРВО



№	Характеристики	Упаковка
22204	150 mm	10
22205	250 mm	10
22198	300 mm	10



FESTA

РЪЧЕН ТРИОН ЗА МЕТАЛ



№	Характеристики	
24104	300 mm	6

FESTA

РЪЧЕН ТРИОН ЗА МЕТАЛ

· Подсилен



№	Характеристики	
24102	300 mm	6

РЪЧЕН ТРИОН ЗА МЕТАЛ

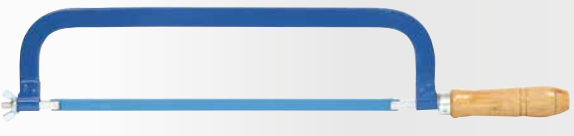

№	Характеристики	
24153	300 mm	12

FESTA

РЪЧЕН ТРИОН ЗА МЕТАЛ



№	Характеристики	
24100	300 mm	12

РЪЧЕН ТРИОН ЗА МЕТАЛ



№	Характеристики	
24170	300 mm	12

FESTA

РЪЧЕН ТРИОН ЗА МЕТАЛ



2x
MADE IN EU

№	Характеристики	
24126	300 x 25 x 0,65 mm TPI 24 14	10

FESTA

НОЖОВКА

· Остриета 24108



№	Характеристики	
24125	150 mm	6

FESTA

НОЖОВКА

· Остриета 24109



№	Характеристики	
24124	260 mm	1210



270 mm
130 mm

РЪЧЕН ТРИОН

№	Характеристики	
24121		12
24110	остриета	30

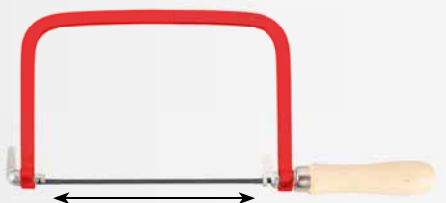

120 mm
165 mm

РЪЧЕН ТРИОН

· 5x Остриета

№	Характеристики	
24122		201
24111	остриета	30

FESTA

РЪЧЕН ТРИОН

TEFLON · По 3 закалени и заточени зъби

№	Характеристики	
24143	300 mm	12
24144	400 mm	12
24145	500 mm	12



FESTA

ТРИОН ПАСВАТЕЛ

TEFLON · По 3 закалени и заточени зъби

№	Характеристики	
24147	300 mm	6



FESTA

РЪЧЕН ПРАВ ТРИОН ЗА ДЪРВО

· По 3 закалени и заточени зъби

№	Характеристики	
24149	300 mm	12



FESTA

ЯПОНСКИ ТРИОН

SK5 · По 3 закалени и заточени зъби

№	Характеристики	
24134	250 mm 0,5 mm	10



FESTA

ЯПОНСКИ ТРИОН

SK5 · По 3 закалени и заточени зъби

№	Характеристики	
24115	260 mm 0,6 mm	10



FESTA

ЯПОНСКИ ТРИОН

SK5 · По 3 закалени и заточени зъби

№	Характеристики	
24114	260 mm 0,6 mm	10

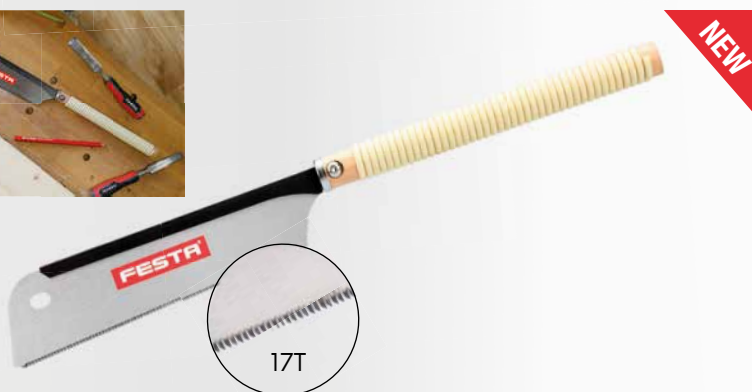

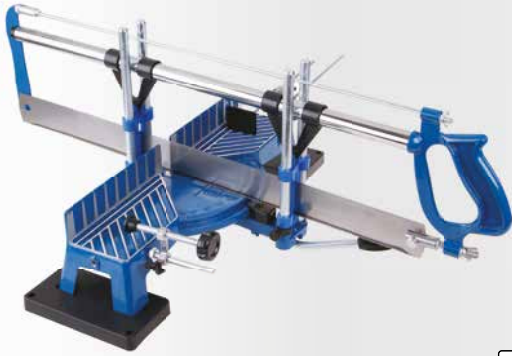

ТРИОН ПАСВАТЕЛ, ПРОФЕСИОНАЛЕН



№	Характеристики	
24130	600 mm	1
24131	600 mm, остриета	1



ТРИОН ПАСВАТЕЛ С PVC ПОСТАВКА



№	Характеристики	
24148	300 mm	25

ПОСТАВКА ЗА ТРИОН ПАСВАТЕЛ, ДЪРВЕНА



№	Характеристики	
24171	80 x 300 mm	10

ПОСТАВКА ЗА ТРИОН ПАСВАТЕЛ



№	Характеристики	
24133	300 x 140 mm	18

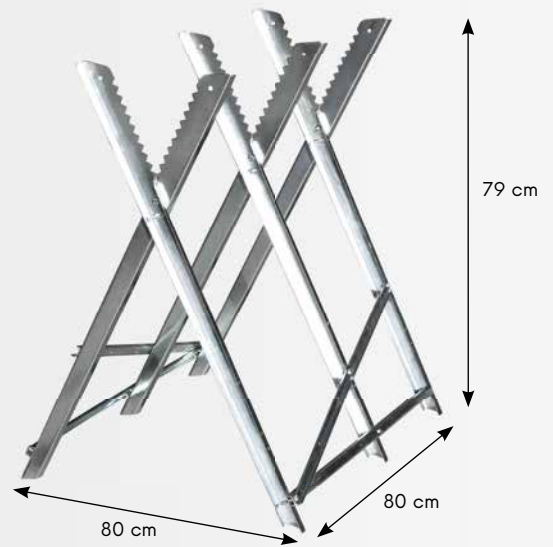

СТОЙКА ЗА РЯЗАНЕ НА ДЪРВО



№	Характеристики	
37570	max. 150 kg	3

FESTA

ГРАДИНСКИ ТРИОН

· Закалени зъби



№	Характеристики		№	Характеристики	
24141	450 mm	12	24136	760 mm	12
24140	533 mm	12	24142	800 mm	12
24135	610 mm	12	24137	914 mm	12

FESTA

ВЪРТЯЩ ТРИОН

· Закалени зъби



№	Характеристики	
24173	350 mm	24

ГРАДИНСКИ ТРИОН



№	Характеристики	
24151	300 mm	10



ГРАДИНСКИ ТРИОН



№	Характеристики	
24150	300 mm	5

ТРИОН ОТ НЕРЪЖДАЕМА СТОМАНА

№	Характеристики	
24128	450 mm Остриета 24192	6



FESTA

СГЪВАЕМ ТРИОН



По 3 закалени и заточени зъби



№	Характеристики	
45061	150 mm с предпазител за ръката	12



FESTA

СГЪВАЕМ ТРИОН



По 3 закалени и заточени зъби



№	Характеристики	
45060	180 mm	6



FESTA

СГЪВАЕМ ТРИОН С КАНИЯ



По 3 закалени и заточени зъби



№	Характеристики	
45062	260 mm с кания	24



ГРАДИНСКИ ТРИОН



По 3 закалени и заточени зъби



№	Характеристики	
24152	350 mm 6 tpi	12

FESTA

ТЕЛЕСКОПИЧЕН ТРИОН С КАНИЯ



По 3 закалени и заточени зъби



№	Характеристики	
45033	230 - 490 mm	1

НОЖИЦА С ТРИОН С ТЕЛЕСКОПИЧНА ДРЪЖКА



№	Характеристики	
45030	пилка 30 cm	6
45031	пилка 30 cm	6

НОЖИЦА С ТРИОН



№	Характеристики	
45032	Метална решетка без трион	6

FESTA

ТРИОН ЗА ПОЛИСТИРЕН



№	Характеристики	
24174	380 mm	1

FESTA

ТРИОН ЗА ГИПСОКАРТОН



По 3 закалени и заточени зъби



№	Характеристики	
24159	150 mm	12

FESTA

ТРИОН ЗА ГАЗОБЕТОН И КУХИ ТУХЛИ



№	Характеристики	
24181	550 mm	1

ПРОБОДЕН ТРИОН ЗА ГИПСОКАРТОН



№	Характеристики	
24190	270 mm	10

FESTA

ТРИОН ЗА ГАЗОБЕТОН И КУХИ ТУХЛИ



№	Характеристики	
24158	22 22 SK зъби - 450 mm	5

FESTA

ТРИОН ЗА ГАЗОБЕТОН И КУХИ ТУХЛИ



№	Характеристики	
24155	34 17 SK зъби - 600 mm	2
24156	34 34 SK зъби - 600 mm	2

FESTA

ТРИОН ЗА ГАЗОБЕТОН И КУХИ ТУХЛИ

· Закалени зъби



№	Характеристики	
24175	bez SK зъби - 600 mm EU	2
24178	bez SK зъби - 600 mm	6

FESTA

ТРИОН ЗА ГАЗОБЕТОН И КУХИ ТУХЛИ

№	Характеристики	
24176	34 17 SK зъби - 750 mm	6
24177	34 34 SK зъби - 750 mm	6





FESTA

ЧУК

· Drška jasen

DIN 1041

№	Характеристики	
19081	100 g	1
19082	200 g	1
19083	300 g	1
19084	400 g	1
19085	500 g	1
19086	600 g	1
19088	800 g	1
19090	1000 g	1
19092	1500 g	1
19095	2000 g	1



FESTA

ЧУК, ДВУСТРАНЕН

· Drška jasen

DIN 1041

№	Характеристики	
19096	3000 g	1
19097	4000 g	1
19098	5000 g	1
19106	6000 g	1
19108	8000 g	1
19109	10000 g	1



FESTA

ЧУК

· Drška jasen

DIN 6475

№	Характеристики	
19041	1000 g	1
19042	1250 g	1
19043	1500 g	1
19044	2000 g	1



FESTA

ЧУК, ДВУСТРАНЕН

· Drška jasen

DIN 6475

№	Характеристики	
19045	3000 g	1
19046	4000 g	1
19074	5000 g	1
19075	6000 g	1
19076	8000 g	1
19077	10000 g	1



FESTA

ЧУК, ФИБРОСТЪКЛО

· Фибростъкло

№	Характеристики	
19021	100 g	12
19022	200 g	12
19023	300 g	12
19024	400 g	12
19025	500 g	12
19026	600 g	6
19028	800 g	6
19030	1000 g	6
19031	1500 g	6
19032	2000 g	1



FESTA

ЧУК, ФИБРОСТЪКЛО

· Фибростъкло

DIN 6475

№	Характеристики	
19066	1000 g	4
19067	1250 g	4
19068	1500 g	4
19069	2000 g	2

FESTA

ЧУК, ФИБРОСТЪКЛО

· Фибростъкло



№	Характеристики	
19034	3000 g	4
19036	4000 g	4



FESTA

ЧУК, ФИБРОСТЪКЛО

· Фибростъкло

DIN 6475

№	Характеристики	
19070	3000 g	4
19071	4000 g	4
19058	5000 g	4
19059	6000 g	2

FESTA

КОФРАЖЕН ЧУК,
ФИБРОСТЪКЛО

· Фибростъкло



№.р.	спецификаци	пакет
19061	600 g	6



FESTA

ЧУК ТИП
"КОЗИ КРАК",
ФИБРОСТЪКЛО

· Фибростъкло

№.р.	спецификаци	пакет
19064	450 g	6



FESTA

КОФРАЖЕН ЧУК,
МОНОЛИТЕН



№.р.	спецификаци	пакет
19062	600 g	6



FESTA

ЧУК ТИП
"КОЗИ КРАК",
МОНОЛИТЕН

№.р.	спецификаци	пакет
19063	450 g	6



КОФРАЖЕН ЧУК



№.р.	спецификаци	пакет
19100	600 g	6



FESTA

ЗИДАРСКИ ЧУК,
МОНОЛИТЕН

№.р.	спецификаци	пакет
19150	600 g	6



FESTA

КОФРАЖЕН ЧУК



№.р.	спецификаци	пакет
19060	600 g	6



FESTA

ЧУК ТИП
"КОЗИ КРАК"

№.р.	спецификаци	пакет
19065	450 g	6



FESTA

ЗИДАРСКИ ЧУК,
ФИБРОСТЪКЛО

· Фибростъкло

№.р.	спецификаци	пакет
19151	600 g	6



FESTA

ЗИДАРСКИ ЧУК

· Дървена дръжка, ясен

№.р.	спецификаци	пакет
19149	44 mm	1



FESTA

ЗИДАРСКИ ЧУК

· Дървена дръжка, ясен

№.р.	спецификаци	пакет
19124	24 mm	1
19136	36 mm	1
19148	48 mm	1



FESTA

БРАДВА-ЧУК

№.р.	спецификаци	пакет
19303	600 g	6



FESTA

ЧУК, ДВУСТРАНЕН

№	спецификации	упаковка
19051	1000 g	6
19052	1500 g	6



ЧУК,
ДВУСТРАНЕН

· Заоблено чело

DIN 6475



№	спецификации	упаковка
19053	1000 g	6
19050	1250 g	6
19054	1500 g	6
19055	2000 g	6

ЧУК

· Заоблено чело

DIN 1041



№	спецификации	упаковка
19001	100 g	12
19002	200 g	12
19003	300 g	6
19004	400 g	6
19005	500 g	6
19006	600 g	6
19008	800 g	6
19010	1000 g	6
19015	1500 g	6
19020	2000 g	6

ЧУК, ДВУСТРАНЕН

· Заоблено чело

DIN 6475



№	спецификации	упаковка
19056	3000 g	6
19057	4000 g	6

ЧУК ЗА ЗАВАРКИ



№	спецификации	упаковка
19115	320 g	1



FESTA

ДЪРВЕНА ДРЪЖКА ЗА ЧУК, ЯСЕН

№	Характеристики	упаковка
61240	Дървена	1



ДЪРВЕНА ДРЪЖКА
ЗА ЧУК, ЯСЕН



№	Характеристики	хамер	упаковка
61320	26 cm	19081	10
61321	28 cm	19082	10
61322	30 cm	19083	10
61323	31 cm	19084	10
61324	32 cm	19085	10



ДЪРВЕНА ДРЪЖКА
ЗА ЧУК, ЯСЕН



№	Характеристики	хамер	упаковка
61330	80 cm	19074, 19075	10
61331	90 cm	19076, 19077	10



КЛИН ЗА БРАДВИ

№	Характеристики	упаковка
19430	6 mm	10
19431	8 mm	10
19432	10 mm	10
19433	12 mm	10
19434	14 mm	10
19435	16 mm	10



КЛИН ЗА БРАДВИ, КОВАН



№	Характеристики	упаковка
19440	Тесен	10
19441	Среден	10
19442	Широк	10
19443	Широк S	10



FESTA

КЛИН ЗА БРАДВИ, СТОМАНЕН



3x

№	Характеристики	упаковка
19398	20 x 25 x 5 mm	1
19399	30 x 40 x 5 mm	1





FESTA



FESTA

ДЪРВЕН ЧУК

· Дървена дръжка, бук



№	Характеристики	
19202	Ø 60 x 120 mm 260 g	1



FESTA

ГУМЕН ЧУК

· Дървена дръжка, ясен



№	Характеристики	
19245	Ø 55 mm 400 g	1
19246	Ø 60 mm 800 g	1
19247	Ø 70 mm 1000 g	1
19248	Ø 95 mm 2000 g	1
19249	Ø 115 mm 3000 g	1

FESTA

ГУМЕН ЧУК

· Фибростъкло



№	Характеристики	
19270	Ø 55 mm	6
19271	Ø 65 mm	6
19272	Ø 90 mm	6



FESTA

ГУМЕН ЧУК



№	Характеристики	
19255	Ø 55 mm	6
19265	Ø 65 mm	6
19290	Ø 90 mm	6



FESTA

ГУМЕН ЧУК, БЯЛ

· Фибростъкло

№	Характеристики	
19281	680g	6



FESTA

ГУМЕН ЧУК, БЯЛ



№	Характеристики	
19293	Ø 55 mm	6
19294	Ø 65 mm	6
19295	Ø 90 mm	6



FESTA

ЧУК, МЕСИНГ

· Фибростъкло

№	Характеристики	
19211	Ø 30 mm 500 g	1



FESTA

ЧУК, ПЛАСТМАСОВ

· Фибростъкло



№	Характеристики	
19209	Ø 34 mm	6



ГУМЕН ЧУК



№	Характеристики	
19251	Ø 55 mm 400 g	12
19252	Ø 65 mm 700 g	6
19253	Ø 90 mm 1300 g	4



ГУМЕН ЧУК



№	Характеристики	
19254	Ø 65 mm	6



FESTA

ЧУК СЪС СМЕНЯЕМИ КРАИЦА

- PP - 97 Shore A ·
- TPU - 95 Shore A ·
- TPE - 90 Shore A ·
- TPE - 90 Shore A ·
- TPU - 92 Shore A ·
- TPU - 92 Shore A ·
- TPU - 88 Shore A ·
- TPE - 90 Shore A ·

ЧУК, СИЛИКОНОВ

№	Характеристики	
19297	Ø 30 mm	12



№	Характеристики	
19208	Ø 38 mm	1

ТЕНЕКЕД-ЖИЙСКИ КОМПЛЕКТ

7x

№ 19110 Характеристики



5



FESTA

ЩАНГА



№	Характеристики	Икона
19420	300 mm	1



FESTA

ЩАНГА ТИП "КОЗИ КРАК"

№	Характеристики	Икона
19424	400 mm	6
19425	600 mm	6
19426	800 mm	6
19427	1000 mm	6



ЩАНГА ТИП "КОЗИ КРАК"

№	Характеристики	Икона
19416	600 mm Ø 16 mm	4
19422	800 mm Ø 16 mm	4
19421	1000 mm Ø 18 mm	4



ЩАНГА ТИП "КОЗИ КРАК"

№	Характеристики	Икона
19423	380 x 35 x 6 mm	1



ЩАНГА ТИП "КОЗИ КРАК"

№	Характеристики	Икона
19415	300 mm Ø 15 mm	6





FESTA

ДЛЕТО, ПЛОСКО (СЕКАЧ)

№	Характеристики	Ширина hrotu	
19406	300 mm	25 mm	5
19407	400 mm	30 mm	5



FESTA

ДЛЕТО, ОСТРО

№	Характеристики	Ширина hrotu	
19408	250 mm		5
19409	350 mm		5



FESTA

ДЛЕТО, ПЛОСКО (СЕКАЧ)

№	Характеристики	Ширина hrotu	
19460	300 mm	25 mm	5
19470	400 mm	30 mm	5



ДЛЕТО, ОСТРО

№	Характеристики	Ширина hrotu	
19400	250 mm		5
19403	350 mm		6



ДЛЕТО, ПЛОСКО (СЕКАЧ)

№	Характеристики	Ширина hrotu	
19401	250 mm	19 mm	6
19404	350 mm	22 mm	6



ДЛЕТО, ПЛОСКО (СЕКАЧ)

№	Характеристики	Ширина hrotu	
19402	250 mm	50 mm	2
19405	350 mm	50 mm	6



FESTA

КОМПЛЕКТ ДЛЕТА ПРОБОЙНИЦИ

12x CrV

- 2, 6, 8 mm
- 10, 12, 16 mm
- Ø 1,5-3-4-5-6-8 mm

№	Характеристики	
19487		4



FESTA

КОМПЛЕКТ ДЛЕТА ПРОБОЙНИЦИ

6x CrV

- 2 x 140, 8 x 115 mm
- 12 x 152, 10 x 142 mm
- Ø 3 x 152, 6 x 152 mm

№	Характеристики	
19486		10



FESTA

КОМПЛ. ДЛЕТА ПРОБОЙНИЦИ

3x CrV

- 10, 12, 16 mm

№	Характеристики	
19485		10



FESTA

ДЛЕТО, ПЛОСКО (СЕКАЧ)

CrV

№	Характеристики	Ширина hrotu	
19429	200 mm		1



FESTA

ДЛЕТО, ПЛОСКО (СЕКАЧ)

CrV

№	Характеристики	Ширина hrotu	
19410	200 mm	20 mm	10
19411	250 mm	25 mm	10
19412	300 mm	25 mm	10
19418	400 mm	25 mm	5
19419	500 mm	25 mm	5



ДЛЕТО, ПЛОСКО (СЕКАЧ)

CrV

№	Характеристики	Ширина hrotu	
19436	200 mm	20 mm	15

FESTA

КОМПЛЕКТ ПРОБОИ

CrV 3x

№	Характеристики	Пакет
19480	Ø 0,8, 1,5, 2,5 mm	10



FESTA

КОМПЛЕКТ ШЛОСЕРСКИ ЦЕНТРИ

CrV 3x

№	Характеристики	Пакет
19481	Ø 0,8, 1,5, 2,5 mm	10



FESTA

КОМПЛЕКТ ДЛЕТА ПРОБОЙНИЦИ

CrV 6x

№	Характеристики	Пакет
19483	Ø 3, 4, 5, 6, 7, 8 mm	5



FESTA

ШЛОСЕРСКИ ЦЕНТЪР

CrV

№	Характеристики	Пакет
19477	Ø 2,5 mm	20



FESTA

АВТОМАТИЧЕН ШЛОСЕРСКИ ЦЕНТЪР

CrV

№	Характеристики	Пакет
19478	Ø 2,5 mm	12



FESTA

ДЛЕТО ПРОБОЙНИК

CrV

№	Характеристики	Пакет
19472	Ø 4 mm 150 mm	1
19473	Ø 5 mm 150 mm	1
19474	Ø 6 mm 150 mm	1



ЕЛМАЗ ЗА РЯЗАНЕ НА СЪТЪКЛО



№	Характеристики	Пакет
20350	130 mm	12



КОМПЛЕКТ ЗАМБИ

- 24690 - Ø 2,5 mm
- Ø 3 mm
- Ø 4 mm
- Ø 5 mm
- Ø 6 mm
- Ø 7 mm
- Ø 8 mm
- Ø 9 mm
- Ø 10 mm
- 24691 - Ø 2mm
- Ø 2,5 mm
- Ø 3,2 mm
- Ø 4 mm
- Ø 4,8 mm
- Ø 5 mm
- Ø 6,4 mm
- Ø 8 mm
- Ø 9,5 mm
- Ø 11,1 mm
- Ø 12,7 mm
- Ø 14 mm
- Ø 15,8 mm
- Ø 19 mm
- Ø 22 mm



№	Характеристики	Пакет
24690	9 бр. Ø 2,5 - 10 mm	10
24691	15 бр. Ø 2 - 22 mm	5

КОМПЛЕКТ ЗАМБИ

№	Характеристики	Пакет
13x 24695	Ø 5, 6, 8, 10, 11, 13, 16, 19, 22, 25, 28, 32, 35 mm	5



ЩЕМПЕЛИ ЗА ЦИФРИ

№	Характеристики	Пакет
20972	6 mm	5
20973	8 mm	5



ЩЕМПЕЛИ ЗА БУКВИ

№	Характеристики	Пакет
20970	6 mm	5
20971	8 mm	5





**СТЯГА
ЗА БЪРЗ
ЗАХВАТ**

№	Характеристики	
23625	150 mm	6
23626	300 mm	6
23628	450 mm	6
23630	600 mm	6
23632	760 mm	6



NEW



**УДЪЛЖИТЕЛЕН
СЪЕДИНИТЕЛ
ЗА СТЯГИ**

FESTA INDUSTRY 23625, 23626, 23628, 23630

2x



№	Характеристики	
23635		6



**СТЯГА ЗА
БЪРЗ ЗАХВАТ**



№	Характеристики	
23570	100 x 80 mm	1
23571	160 x 80 mm	1
23572	200 x 80 mm	1
23573	250 x 80 mm	1
23574	300 x 80 mm	1

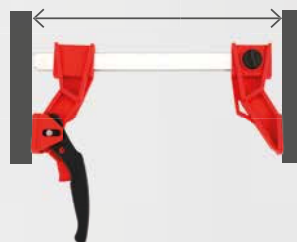

СТЯГА, СТОМАНЕНА

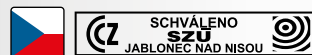

№	Характеристики	
23670	150 x 105 mm	1
23671	200 x 105 mm	1
23672	250 x 105 mm	1
23673	300 x 105 mm	1
23674	350 x 105 mm	1
23675	400 x 175 mm	1
23676	500 x 175 mm	1
23677	600 x 175 mm	1
23678	700 x 175 mm	1
23679	800 x 175 mm	1
23680	1000 x 175 mm	1
23681	1250 x 175 mm	1
23682	1500 x 175 mm	1
23683	1750 x 175 mm	1
23684	2000 x 175 mm	1
23685	2200 x 175 mm	1



**СТЯГА
ЗА БЪРЗ
ЗАХВАТ**

№	Характеристики	
23585	150 mm	6
23587	300 mm	6
23589	450 mm	6
23591	600 mm	6



FESTA

СТЯГА ЗА БЪРЗ ЗАХВАТ

Ковано

№	Характеристики	
23560	200 x 80 mm	1
23561	300 x 100 mm	1
23562	400 x 100 mm	1
23563	500 x 120 mm	1
23564	600 x 120 mm	1
23565	800 x 120 mm	1
23566	1000 x 120 mm	1



СТЯГА

DIN 5117

№	Характеристики	
23506	300 x 120 mm	10
23507	500 x 120 mm	10
23508	800 x 120 mm	6



СТЯГА

№	Характеристики	
23515	150 x 50 mm	50
23520	200 x 50 mm	50
23525	250 x 50 mm	50
23530	300 x 50 mm	50
23531	300 x 120 mm	20
23551	500 x 120 mm	10



NEW



FESTA

СКОБА ЗА ДЪРВО-ОБРАБОТВАЩА МАСА

№	Характеристики	
23595	250/ Ø 20 mm 60 kg	1



NEW



FESTA

СКОБА ЗА ДЪРВО-ОБРАБОТВАЩА МАСА

№	Характеристики	
23598	120/ Ø 20 mm 70 kg	1

NEW



FESTA

ПРАВОЪГЪЛНА СКОБА ЗА РАМКИ

№	Характеристики	
23637	4m x 25mm	1





FESTA

90° МЕНГЕМЕ



4x

№	Характеристики	Пакет
23607	сила на затягане- 250 N	1

АЛУМИНИЕВО
МЕНГЕМЕ,
РОТАЦИОННО, 90°

ALU

· степен 0 - 65 mm



№	Характеристики	Пакет
23420	65 mm	20



НАЗЪБЕНА СТЯГА С ТРЕСЧОТКА

· Обхват 80 mm

№	Характеристики	Пакет
23605	9' 230 mm	6

СТЯГА, ПЛАСТМАСОВА

№	Характеристики	Пакет
23600	4', Обхват 40 mm	20
23601	6', Обхват 70 mm	12
23602	9', Обхват 100 mm	20

КОМПЛЕКТ G-СТЯГИ

3x

№	Характеристики	Пакет
23620	25 mm, 50 mm, 75 mm	10



FESTA



208

РАБОТНИ МАСИ



212

МЕНГЕМЕТА



213

ХИДРАВЛИЧНИ КРИКОВЕ



218

ОСВЕТИТЕЛНИ ТЕЛА



220

УКРЕПВАЩИ КОЛАНИ



224

ЕЛЕКТРОИЗОЛАЦИОННИ И
МАСКИРАЩИ ЛЕНТИ

227

КАРАБИНЕРИ, ВЕРИГИ,
ТАКЕЛАЖ

230

ЗАЩИТНО ОБЛЕКЛО



234

КОЛАНИ, ЧАНТИ И КУФАРИ



237

ПАТРОНИ И КАТИНАРИ



239

КАСИ ЗА ПАРИ,
ПОЩЕНСКИ КУТЦИИ

РАБОТИЛНИЦА

208 - 243



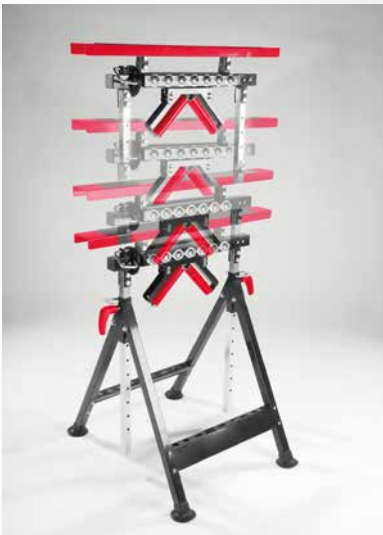

max 200 kg



max 45 kg



max 100 kg



max 100 kg



FESTA

РЕГУЛИРУЕМА СТОЙКА ЗА РЯЗАНЕ

· max.: 200 kg

№ 36410 Характеристики

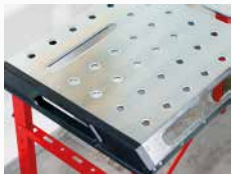

FESTA

МАСА ЗА ЗАВАРИВАЊЕ

· max.: 450 kg

№ 23652 Характеристики



FESTA

РЕГУЛИРУЕМА СТОЙКА ЗА РЯЗАНЕ

· max.: 590 kg

№ 23657 Характеристики



NEW



2x



4x

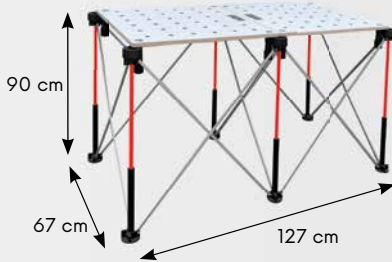
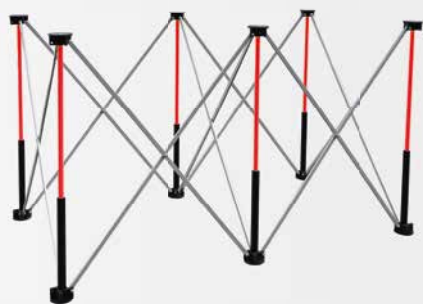

FESTA

РАЗТЕГАТЕЛНА РАБОТНА МАСА, СЪВМЕСТИМ С 23664

· 1270 x 670 x 900 mm
· max.: 1100 kg



№ Характеристики
23661 1

NEW



FESTA

РАБОТЕН ПЛОТ, СЪВМЕСТИМ С 23661

· 1200 x 600 x 18 mm



№ Характеристики
23664 1



FESTA

РЕГУЛИРУЕМА СТОЙКА ЗА РЯЗАНЕ

· max.: 230 kg



№ Характеристики
23658 1

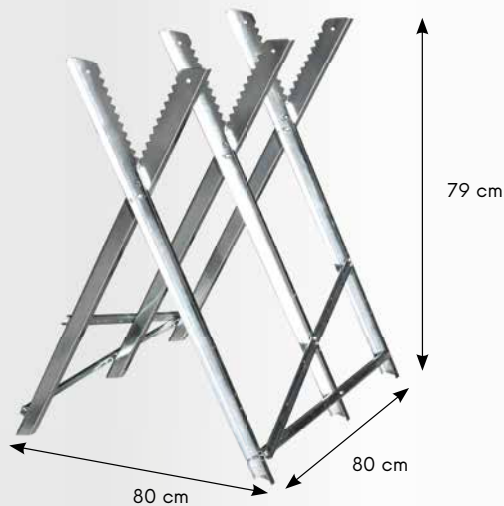

РЕГУЛИРУЕМА СТОЙКА ЗА РЯЗАНЕ

· max.: 150 kg



№ Характеристики
37570 1



РЕГУЛИРУЕМА СТОЙКА ЗА РЯЗАНЕ

· max.: 125 kg



№ Характеристики
36300 1



РЕГУЛИРУЕМА СТОЙКА ЗА РЯЗАНЕ - ПЛАСТМАСА

· Max. 150 kg (300 kg чифт)

2x

№ Характеристики
37560 1



РЕГУЛИРУЕМА СТОЙКА ЗА РЯЗАНЕ

· max. 125 kg

№	Характеристики	Икона
37549	Чифт	1

РАБОТНА МАСА

· max. 100 kg

№	Характеристики	Икона
23655	100 x 50 x 84 cm	1



РАБОТНА МАСА

· Идеална за използване в сутерен

№	Характеристики	Икона
23660		1



РАБОТНА МАСА

· max.: 100 kg

№	Характеристики	Икона
23650		1

АВТОСЕРВИЗНО
СТОЛЧЕ НА КОЛЕЛАПластмасово, с подпънка
и тава за инструменти.

№	Специфика	Икона
26988	360 x 365 x 365 mm	1

FESTA

МАГНИТНА СТОЙКА ЗА КЛЮЧОВЕ



№	Характеристики
70098	



№	Характеристики
12	

**FESTA****КОЛИЧКА ЗА ИНСТРУМЕНТИ**

№	Механизъм на чекмеджетата	Брой чекмеджета	Среден размер (mm)	
26986	Плъзгащи	7	680 x 460 x 1020 mm	1

**КОЛИЧКА ЗА ИНСТРУМЕНТИ В ДВЕ ЧАСТИ**

Горната част може да се съхранява в долната.

№	Характеристики	Механизъм на чекмеджетата	Брой чекмеджета	Размери на чекмеджетата WxDxH (mm)	Среден размер	Тегло	
26985	Горна част	Плъзгащи	3	151,5 x 225 x 40 mm	600 x 260 x 340 mm	11,5 kg	1
			2	511 x 225 x 40 mm			
	Долна част	Плъзгащи	1	511 x 225 x 85 mm	616 x 330 x 742 mm	16,4 kg kg	
			2	511 x 308 x 85 mm			

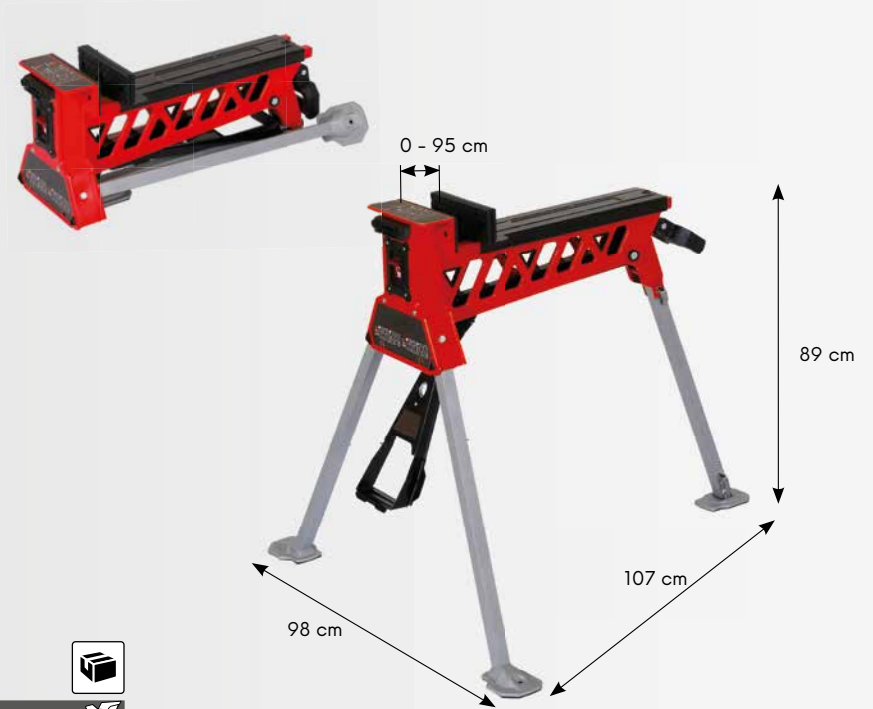
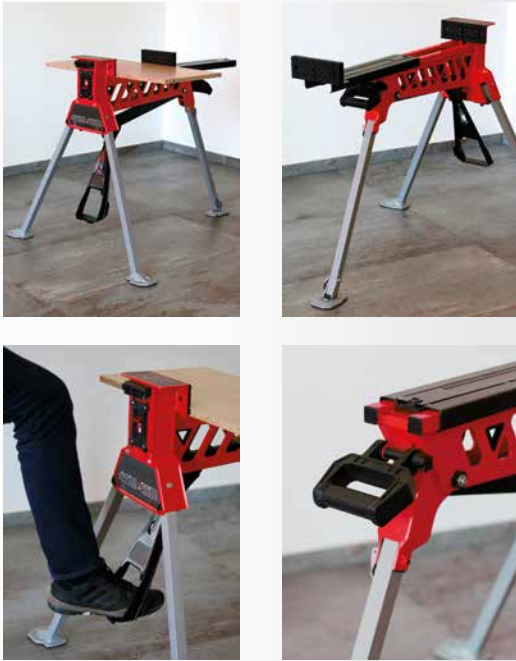

FESTA

ПРЕНОСИМО МЕНГЕМЕ ЗА СТОЙКА

- диапазон: 0- 95 cm
- max.: 250 kg

№	Характеристики
37553	



FESTA

МЕНГЕМЕ

- Закалени челюсти

№	Характеристики		
23410	100 mm	1	
23411	125 mm	1	
23412	150 mm	1	



МЕНГЕМЕ, РОТАЦИОННО

- Закалени челюсти

№	Характеристики		
23415	100 mm	1	
23416	125 mm	1	
23417	150 mm	1	



МЕНГЕМЕ, РОТАЦИОННО

№	Характеристики	
23407	65 mm	10



МЕНГЕМЕ ЗА ПРОБИВАНЕ

- Закалени челюсти

№	Характеристики	
23400	18 80 mm	10
23401	22 100 mm	10
23402	24 125 mm	5



НАСТОЛНО АЛУМИНИЕВО МЕНГЕМЕ, РОТАЦИОННО, 360°

ALU	№	Характеристики	
	23406	80 mm	24



ХИДРАВЛИЧЕН КРИК, ТИП БУТИЛКА, С ЕДНО БУТАЛО

Винт за фино регулиране на височината и максимално повдигане
 Двоен предпазен клапан
 Голяма релефна контактна повърхност и сигурно повдигане
 Масивна основа за повече стабилност и дълъг експлоатационен живот. Всички силно натоварени точки са подсилени за допълнителна издръжливост и безопасност при работа.



№	Товароподемност	Мин. височина	Повдигане	Регулируема височина	Размери	Тегло	
26800	2 000 kg	181mm	116 mm	48 mm	88 x 92 mm	2,6 kg	1
26801	3 000 kg	194 mm	118 mm	60 mm	92 x 100 mm	3,3 kg	1
26802	5 000 kg	216 mm	127 mm	70 mm	96 x 112 mm	4,5 kg	1
26803	8 000 kg	230 mm	147 mm	80 mm	103 x 118 mm	5,7 kg	1
26804	10 000 kg	230 mm	150 mm	80 mm	110 x 123 mm	6,8 kg	1
26805	12 000 kg	230 mm	155 mm	80 mm	116 x 134 mm	7,3 kg	1
26806	15 000 kg	230 mm	150 mm	80 mm	133 x 136 mm	8,4 kg	1
26807	20 000 kg	242 mm	150 mm	60 mm	144 x 152 mm	11 kg	1



ХИДРАВЛИЧЕН КРИК, ТИП БУТИЛКА, ДВУБУТАЛЕН

Винт за фино регулиране на височината и максимално повдигане
 Двоен предпазен клапан
 Голяма релефна контактна повърхност и сигурно повдигане
 Масивна основа за повече стабилност и дълъг експлоатационен живот.
 Всички силно натоварени точки са подсилени за допълнителна издръжливост и безопасност при работа.



№	Товароподемност	Мин. височина	Повдигане	Регулируема височина	Тегло	
26815	2 000 kg	150 mm	160 mm	60 mm	4,7 kg	1
26816	4 000 kg	160 mm	170 mm	60 mm	6,4 kg	1
26817	6 000 kg	215 mm	270 mm	-	8,9 kg	1
26819	10 000 kg	228 mm	284 mm	89 mm	10,2 kg	1



НОЖИЧЕН КРИК



№	Товароподемност	Мин. височина	Макс. височина	Тегло	
26844	1 000 kg	88 mm	380 mm	2,5 kg	1
26845	2 000 kg	120 mm	395 mm	3,5 kg	1



ХИДРАВЛИЧЕН КРИК КОЛИЧКА



№	Характеристики	Товароподемност	Мин. височина	Макс. височина	Тегло	
26820	Хидравличен крик количка, 2 t, преносим	2 000 kg	130 mm	345 mm	9,6 kg	1
26822	Хидравличен крик количка, 3 t, преносим	3 000 kg	130 mm	465 mm	27,4 kg	1
26826	Хидравличен нископрофилен крик с въртене на 360°	2 000 kg	89 mm	359 mm	14,2 kg	1
26824	Хидравличен нископрофилен крик с крачен педал	3 000 kg	145 mm	500 mm	37,2 kg	1
26825	Хидравличен нископрофилен крик, profi	2 500 kg	85 mm	455 mm	34,8 kg	1

ХИДРАВЛИЧЕН КРИК КОЛИЧКА + ПОДПОРИ

· Дръжка с въртене на 360°



№	Товароподемност	Мин. височина	Макс. височина	Тегло	
26829	2 000 kg	130 mm	350 mm	10,5 kg	1
	2 000 kg	275 mm	420 mm	5 kg (pair)	



ПОДПОРИ ЗА КРИК

1 брой = 1 чифт

С тресчотка за по-фина настройка

С двойно заключване за по-добра защита

Масивна стоманена ръкохватка

Широка основа и стабилна конструкция

Носеща част от чугун.



№	Характеристики	Товароподемност	Мин. височина	Макс. височина	Тегло	
26857	Със заключване	2 000 kg	275 mm	420 mm	4,8 kg	1
26858	Със заключване	3 000 kg	285 mm	425 mm	6,3 kg	1
26859	Със заключване	6 000 kg	393 mm	593 mm	13 kg	1
26853		12 000 kg	465 mm	715 mm	28 kg	1

ХИДРАВЛИЧЕН КРИК ТИП ЖИРАФ (СГЪВАЕМ)

За повдигане и фиксиране на товари при автосервизна дейност. Стрела с няколко позиции и разширения. Мобилен и лесен за съхранение.

№	Товароподемност	Мин. височина	Макс. височина	Тегло	
26862	2 000 kg	0	2360 mm	88 kg	1



СКОБА ЗА ЗАКАЧВАНЕ НА ДВИГАТЕЛ

Окачване в зависимост от наклона на предния капак. Подсигураване на винаги стабилна и балансирана основа за автосервизни дейности.

№	Товароподемност	Дължина	Обхват	Тегло	
26871	500 kg	1500 mm	150 mm	20,3 kg	1



ХИДРАВЛИЧЕН КРИК ЗА СКОРОСТНА КУТИЯ

За лесен монтаж и демонтаж на двигатели, скоростни кутии, оси и др.

№	Характеристики	Товароподемност	Дължина	Обхват	Тегло	
26880	Хидравличен крик	500 kg	1100 mm	1900 mm	30,0 kg	1



26880

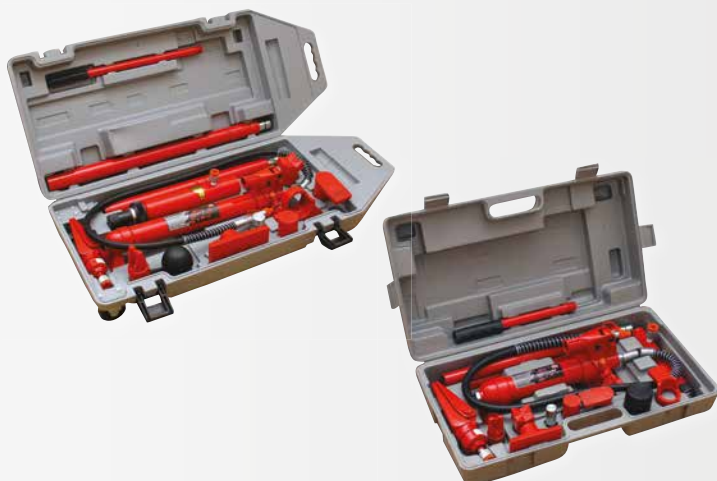

ПРЕНОСИМО ХИДРАВЛИЧНО ОБОРУДВАНЕ, С КУФАР

Преносимо хидравлично оборудване за автосервизни дейности. Състои се от хидравличен крик и 14 аксесоара. Позволява широка гама от приложения за ремонт на леки и тежкотоварни автомобили и осигурява удобство при ремонт извън работното помещение при неналичие на електричество. Оборудването може да се използва за повдигане, издърпване, бутане и разтягане както в хоризонтална, така и във вертикална посока. Предлага се с куфар за по-лесен транспорт.



№	Товароподемност	Повдигане	Тегло	
26886	4 000 kg	125 mm	17,0 kg	1
26888	10 000 kg	135 mm	32,0 kg	1



СТЕНД ЗА РЕМОТ НА ДВИГАТЕЛИ

Преносим стенд за ремонт на демонтирани двигатели. Универсална скоба за затягане и позициониране на двигатели.



№	Товароподемност	Тегло	
26920	450 kg	20 kg	1



ХИДРАВЛИЧНА МАШИНА ЗА ОГЪВАНЕ НА ТРЪБИ

№	Товароподемност	Повдигане	Колене	Тегло	
26895	12 000 kg	232 mm	1 2", 3 4", 1", 1-1 4", 1-1 2", 2"	36 kg	1
26896	16 000 kg	238 mm	1 2", 3 4", 1", 1-1 4", 1-1 2", 2", 2-1 2", 3"	65 kg	1



26897



26943

ПРУЖИНЕН КОМПРЕСОР

26897- За смяна на пружини тип McPherson директно в автомобила.

26943- За смяна на пружини тип McPherson извън автомобила. Стабилни стоманени профили за по-висока устойчивост.



№	Товароподемност	Ø на пружината	Обхват	Тегло	
26897	1 000 kg	100-200 mm	150 mm	24,5 kg	1
26943	1 000 kg	400 mm	210-570 mm	35 kg	1



МАШИНА ЗА ИЗТОЧВАНЕ НА МАСЛО

Маслото се отвежда от двигателя в дренажния съд. Маслото се изсмуква пневматично от колектора чрез сгъстен въздух.



№	Обем	Макс. налягане	Тегло	
26954	90 l	0,5 MPa	28 kg	1



ХИДРАВЛИЧНА ПРЕСА

№	Обхват	Товароподемност	Тегло	
26940	0 - 610 mm	12 000 kg	43 kg	1
26941	0 - 880 mm	20 000 kg	75 kg	1

ХИДРАВЛИЧЕН ЦИЛИНДЪР КРИК



№	Характеристики	Товароподемност	Мин. дължина	Макс. дължина	Тегло	
26911	с 1 бутало	5 000 kg	620	1100	12 kg	2
26912	с 1 бутало	8 000 kg	620	1100	13 kg	2
26914	двубутален	5 000 kg	620	1100	12 kg	2
26915	двубутален	8 000 kg	620	1100	14 kg	2



РЕЗЕРВНИ ЧАСТИ ЗА ПЯСЪКО-СТРУЙНИ КАМЕРИ

№	rozméry	
26973	gloves	1
26974	nozzles	1
26975	foil 53,5 x 26 cm	1
26976	plexiglass 60 x 30 cm	1
26977	glass 60 x 30 cm	1

ПЯСЪКОСТРУЙНА КАМЕРА

№	Компресиран въздух	Външни размери	Размери на камерата	Макс. налягане	Тегло	
26972	420-710 l/min.	1500 x 830 x 630 mm	600 x 840 x 630 mm	8 bar	38 kg	1

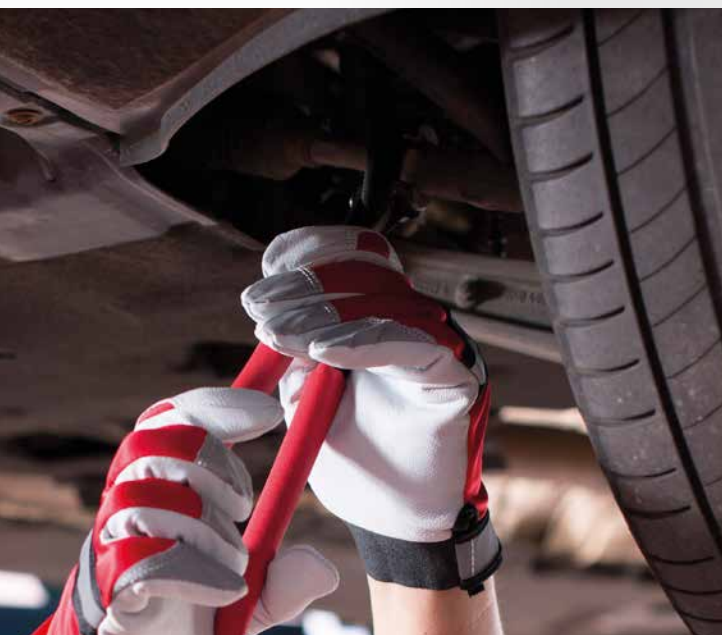

МИВКА ЗА ПОЧИСТВАНЕ НА АВТОЧАСТИ

За измиване на части и аксесоари.



№	Обем	Обем на почист. течност	Дебит	Макс. температура	Тегло	
26961	90 l	45 l	10-12 l/min.	50°C	25 kg	1
26963	180l	150 l	20 l/min	50°C	42 kg	1



МАСЛЪОНКА, МЕТАЛНА

№	Характеристики	
50020	300 ml	10

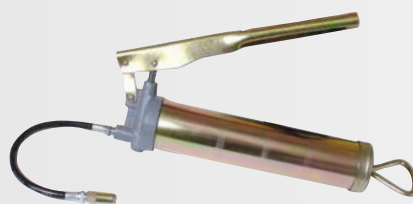

ПИСТОЛЕТ ЗА ГРЕСИРАНЕ

- Директно зареждане
- Зареждане чрез касета
- Зареждане чрез диспенсер

№	Характеристики	
50022	400 ml	20



БАРЕЛ ПОМПА

№	Характеристики	
50017		10



МАСЛЪОНКА, ПЛАСТМАСОВА

№	Характеристики	
50019	90 ml	1



КЛЮЧ ЗА ФИЛТРИ С РЕМЪК

№	Характеристики	
50021	60 x 140 mm	6



ФУНИЯ, РЕГУЛИРУЕМА

№	Характеристики	
50025	60 x 140 mm	50



МАРКУЧ ЗА ПРЕХВЪРЛЯНЕ СЪС САМОЗАСМУКВАЩ КЛАПАН

№	Дължина	Ø	
50026	180 cm	15 mm	24

МАГНИТНА КУПА

№	Характеристики	
26996	200 x 20 mm	1

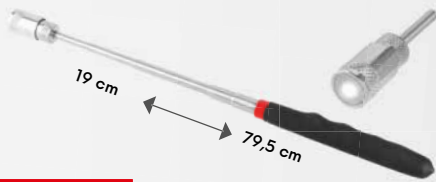

FESTA

ТЕЛЕСКОПИЧЕН ДЪРЖАЧ, МАГНИТЕН - LED

№	Характеристики	
13294	3x LR44	6

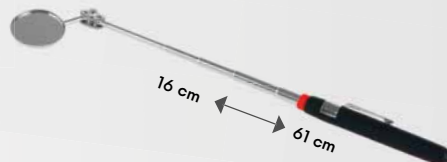

ТЕЛЕСКОПИЧНО ОГЛЕДАЛО

№	Характеристики	
13290		20

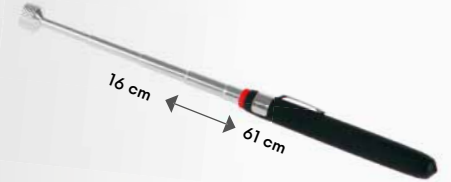

ТЕЛЕСКОПИЧЕН ДЪРЖАЧ, МАГНИТЕН

№	Характеристики	
13293		20



ЩИПКА ЗА СМЕТ

· Въртене на 90°

№	Дължина	
61235	81 cm	12

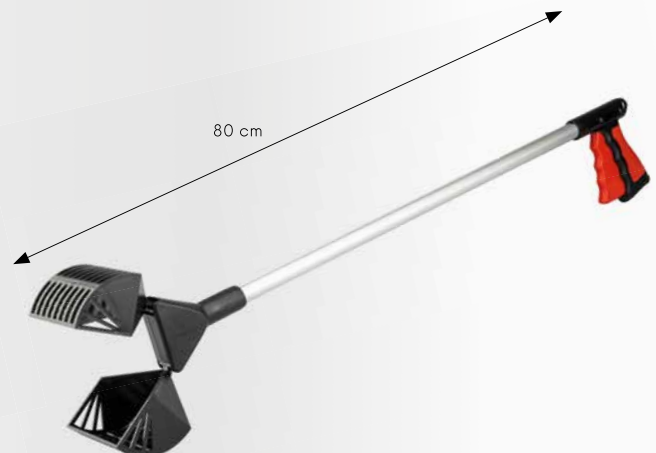

ЩИПКА ЗА СМЕТ

· Max. 4 kg

№	
61236	12

FESTA



NEW



FESTA
INDUSTRY

РАБОТНА LED ЛАМПА

3xLED	80, 200, 300 lm	3W COB LED	USB TYPE C	Li-ion 3.7V 0.8Ah	120 min
95 g	0-180°	IK07	IP54		

№ 37647 Характеристики 3,7V 800 mAh





FESTA

РАБОТНА LED ЛАМПА

№	Характеристики		
37645	200 mm	3 x AAA	12

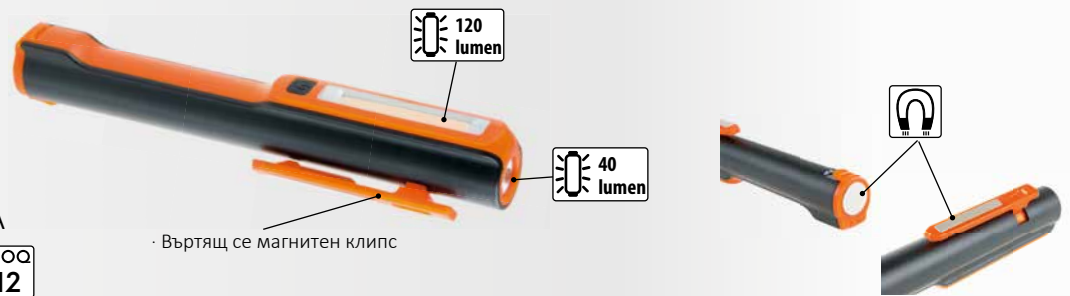

FESTA

LED ФЕНЕР ЧЕЛНИК

Тегло	47 g
Източник	1 x 1 W white LED + 2x red LED
Батери	3 x AAA
Размери	40 x 59 x 32 mm
Време за работа	45 h
Мощност	120 lumen
Обхват	60 m (100% battery)
Режими	4

5 позиции

№	Характеристики		
37641	2 цвята светлина, бяла и червена		1

FESTA

РАБОТЕН LED ФЕНЕР С АЛУМИНИЕВ КОРПУС

№	Характеристики		
37630	185 mm	2 x AA	20



FESTA

LED ФЕНЕР

№	
37650	12

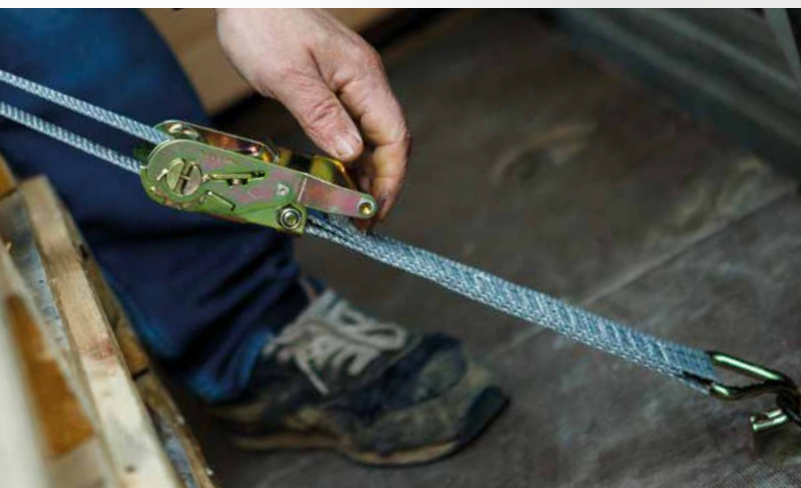

**FESTA**УКРЕПВАЩ
КОЛАН
С ТРЕСЧОТКА

2x



№	Широчина	Дължина	Товароподемност	Броя	
51070	18 mm	2 m	100 kg	2	12

FESTAУКРЕПВАЩ
КОЛАН
С ТРЕСЧОТКА

2x



№	Широчина	Дължина	Товароподемност	Броя	
51072	35 mm	4 m	500 kg	1	6

FESTAУКРЕПВАЩ
КОЛАН
С ТРЕСЧОТКА

2x



№	Широчина	Дължина	Товароподемност	Броя	
51060	25 mm	5 m	750 kg	2	5

FESTAУКРЕПВАЩ
КОЛАН
С ТРЕСЧОТКА

2x



№	Широчина	Дължина	Товароподемност	Броя	
51026	75 mm	5 m	3000 kg	1	4

FESTAУКРЕПВАЩ КОЛАН
С ТРЕСЧОТКА

2x



№	Широчина	Дължина	Товароподемност	Броя	
51017	50 mm	6 m	480 kg	2	5
51018	50 mm	6 m	480 kg	1	10

FESTAУКРЕПВАЩ
КОЛАН
С ТРЕСЧОТКА

№	Широчина	Дължина	Товароподемност	Броя	
51071	25 mm	3,5 m	300 kg	1	8

FESTAУКРЕПВАЩ КОЛАН
С ТРЕСЧОТКА

№	Широчина	Дължина	Товароподемност	Броя	
51040	25 mm	6 m	1000 kg	1	1
51041	35 mm	8 m	2000 kg	1	1
51042	35 mm	8 m	3000 kg	1	1
51043	50 mm	10 m	5000 kg	1	1

FESTAУКРЕПВАЩ
КОЛАН
С ТРЕСЧОТКА

№	Широчина	Дължина	Товароподемност	Броя	
51065	50 mm	10 m	960 kg	1	6

FESTAУКРЕПВАЩ КОЛАН
С ТРЕСЧОТКА

№	Широчина	Дължина	Товароподемност	Броя	
51032	25 mm	5 m	500 kg	1	6



УКРЕПВАЩ КОЛАН С ТРЕСЧОТКА

№	Широчина	Дължина	Характеристики	Броя
51022	25 mm	5 m	С куки	40
51023	50 mm	5 m	С куки	12

FESTA

РЕМЪК С КАТАРАМА

· Омекотена EVA подложка



№	Широчина	Дължина	Броя
51046	38 mm	4 m	1 20



УКРЕПВАЩ КОЛАН С ТРЕСЧОТКА

№	Широчина	Дължина	Характеристики	Броя
51030	50 mm	6 m	С куки	20
51034	50 mm	8 m	С куки	10

РЕМЪК С КАТАРАМА

2x



№	Широчина	Дължина	Броя
51020	25 mm	2,5 m	2 100



РЕМЪК С КАТАРАМА

PE

№	Широчина	Дължина	Броя
51045	25 mm	4 m	1 50

ГУМЕН ЗАТЕГАЧ РЕГУЛИРУЕМ, С КУКА

2x



№	Дължина	Ø	Броя
51013	1,2 m	8 mm	2 1



ГУМЕН ЗАТЕГАЧ С КУКА

2x

№	Дължина	Броя
51008	1 m	2 25



ГУМЕН ЗАТЕГАЧ С КАРАБИНЕР

№	Дължина	Ø	Броя
51009	1 m	10 mm	1 25



КОМПЛЕКТ ГУМЕНИ ЗАТЕГАЧИ С КУКИ

8x

- 2 x 0,4 m
- 2 x 0,6 m
- 1 x 0,8 m
- 1 x 1,0 m

№	Дължина	Ø	Броя
51011	1 m	8 mm	8 10

ГУМЕН ЗАТЕГАЧ С КУКА

2x



№	Дължина	Ø	Броя
51001	80 cm	10 mm	2 50
51002	100 cm	10 mm	2 50
51003	150 cm	10 mm	2 50
51004	200 cm	10 mm	2 50



ГУМЕН ЗАТЕГАЧ С КУКА

2x

№	Дължина	Ø	Броя
51007	1 m	8 mm	2 25

ГУМЕНО ВЪЖЕ ТИП ПАЯК

№	Дължина	Ø	Характеристики	Броя
51010	80 cm	8 mm	8 рамена	50



ГУМИРАНА МРЕЖА С КУКИ



№	Дължина	Широчина	
51015	80 cm	120 cm	20

ГУМИРАНО ВЪЖЕ, ЕЛАСТИЧНО



№	Дължина	Ø	
51036	20 m	8 mm	10
51037	20 m	10 mm	6

КУКИ ЗА ЗАТЯГАНЕ, ГУМИРАНИ



20x

№	Ø	
51038	10 mm	30

КАРАБИНЕР, АЛУМИНИЕВ

ALU

MOQ 2

№	Ø	Дължина	
51200	6 mm	60 mm	2
51202	7 mm	70 mm	2
51201	8 mm	80 mm	2
51203	10 mm	100 mm	2

ВЪЖЕ, ИНДУСТРИАЛНО



№	Дължина	Ø	
50915	5 m	8 mm	1
50916	25 m	8 mm	1
50917	25 m	10 mm	1
50918	25 m	12 mm	1
50919	25 m	14 mm	1

НАЙЛОНОВО ВЪЖЕ

№	Дължина	Ø	
51055	80 m	1,5 mm	50
51056	50 m	2 mm	50
51057	20 m	4 mm	50



НАЙЛОНОВО ВЪЖЕ

№	Дължина	Ø	
51050	50 m	8 mm	10
51051	50 m	10 mm	4



ПОЛИПРОПИЛЕНОВ КАНАП

№	Тегло	
50905	80 g	80
50906	100 g	100
50907	200 g	50



ПОЛИПРОПИЛЕНОВ КАНАП

№	Тегло	
50909	500 g (250 m)	1
50910	1000 g (500 m)	1
50911	5000 g (2500 m)	1



ЮТЕНО ВЛАКНО

№	Тегло	
50900	80 g (61 m)	1
50901	100 g (76 m)	1
50902	200 g (153 m)	1



ВОСЪЧЕН ШНУР



№	Дължина	Ø	
50920	50 m	1 mm	80



ТЕЛЕНА ВЪРЗАНКА ЗА ЧУВАЛИ

1000x

№	Характеристики	
42365	1,25 100 mm	1
42366	1,25 125 mm	1
42367	1,25 140 mm	1
42368	1,25 160 mm	1



КУКА ЗА ВЪРЗВАНЕ НА ТЕЛ. ВЪРЗАНКА И АРМАТУРА

№	Характеристики	
50052		12
50050		1

КУКА ЗА ВЪРЗВАНЕ НА ТЕЛ. ВЪРЗАНКА И АРМАТУРА

№	Характеристики	
50051		2



КАБЕЛНИ СТЯЖКИ

50x · EN 50146 · Nylon

№	Дължина	Широчина	
23875	120 mm	4,8 mm	1



КАБЕЛНИ СТЯЖКИ, ЦВЕТНИ

100x · EN 50146 · Найлон

№	Дължина	Широчина	
23880	100 mm	2,5 mm	1
23882	150 mm	2,5 mm	1
23884	200 mm	3,6 mm	1



КАБЕЛНИ СТЯЖКИ, БЕЛИ

50x · EN 50146 · Найлон

№	Дължина	Широчина	
23850	120 mm	2,5 mm	1
23854	200 mm	3,6 mm	1
23856	250 mm	3,6 mm	1
23858	250 mm	4,8 mm	1
23860	300 mm	4,8 mm	1
23864	400 mm	4,8 mm	1
23866	500 mm	4,8 mm	1
23868	400 mm	7,6 mm	1
23870	500 mm	7,6 mm	1



КАБЕЛНИ СТЯЖКИ, ЧЕРНИ

50x · EN 50146 · Найлон

№	Дължина	Широчина	
23810	120 mm	2,5 mm	1
23814	200 mm	3,6 mm	1
23816	250 mm	3,6 mm	1
23818	250 mm	4,8 mm	1
23820	300 mm	4,8 mm	1
23824	400 mm	4,8 mm	1
23826	500 mm	4,8 mm	1
23828	400 mm	7,6 mm	1
23830	500 mm	7,6 mm	1



ПРЕЗРАМКИ С ДРЪЖКА

10x

№	Дължина	Широчина	
23865	160 mm	7,5 mm	1



СТРЕЧ ФОЛИО

№	Широчина	Дължина	Дебелина	Цвят	
38095	500 mm	600 m	8 µm	Прозрачен	1
38097	100 mm	150 m	20 µm	Прозрачен	1
38096	500 mm	200 m	23 µm	Черен	1



РЕ ЧУВАЛ ЗА СТРОИТЕЛНИ ОТПАДЪЦИ ПРОЗРАЧЕН

№	Широчина	Дължина	Дебелина	бр.	
39194	500 mm	1100 mm	0,16 mm	100 1	10
39196	600 mm	1200 mm	0,16 mm	110 1	10
39198	700 mm	1100 mm	0,16 mm	120 1	10
39200	500 mm	1100 mm	0,20 mm	100 1	10
39202	600 mm	1200 mm	0,20 mm	110 1	10
39204	700 mm	1100 mm	0,20 mm	120 1	10



РЕ ЧУВАЛ ЗА СТРОИТЕЛНИ ОТПАДЪЦИ, ЧЕРЕН

№	Широчина	Дължина	Дебелина	бр.	
39195	500 mm	1100 mm	0,16 mm	100 1	10
39197	600 mm	1200 mm	0,16 mm	110 1	10
39199	700 mm	1100 mm	0,16 mm	120 1	10
39201	500 mm	1100 mm	0,20 mm	100 1	10
39203	600 mm	1200 mm	0,20 mm	110 1	10
39205	700 mm	1100 mm	0,20 mm	120 1	10



ЧУВАЛ ЗА ОТПАДЪЦИ

№	Широчина	Дължина	Дебелина	бр.	
38060	700 mm	1100 mm	0,08 mm	10	1
38063	700 mm	1100 mm	0,10 mm	3	1
38065	700 mm	1100 mm	0,20 mm	3	1



ЧУВАЛ ЗА ОТПАДЪЦИ

№	Широчина	Дължина	Дебелина	бр.	
38050	500 mm	600 mm	0,04 mm	25	1
38052	600 mm	800 mm	0,04 mm	25	1
38054	700 mm	1100 mm	0,04 mm	25	1



РЕ ЧУВАЛ ЗА СТРОИТЕЛНИ ОТПАДЪЦИ

5x

№	Широчина	Дължина	Дебелина	
38055	1200 mm	1000 mm	0,08 mm	5

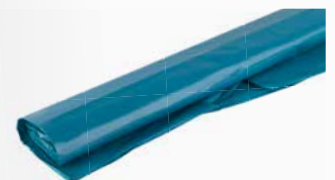



ПРЕДУПРЕДИТЕЛНА ЛЕНТА - ЕЛЕКТРОПРОВОД

№	Широчина	Дължина	
38955	22 cm	20 m	1
38956	22 cm	50 m	1



ПРЕДУПРЕДИТЕЛНА ЛЕНТА - ВОДА

№	Широчина	Дължина	
38957	22 cm	20 m	1
38958	22 cm	50 m	1



ПРЕДУПРЕДИТЕЛНА ЛЕНТА - ГАЗ

№	Широчина	Дължина	
38959	22 cm	20 m	1
38960	22 cm	50 m	1



ПРЕДУПРЕДИТЕЛНА ЛЕНТА

№	Характеристики	Дължина	
38944	ZAKAZ VSTUPU, SK	80 mm 250 m	8
38945	VSTUP ZAKAZAN, CZ	80 mm 250 m	8



ПРЕДУПРЕДИТЕЛНА ЛЕНТА

№	Дължина	
38948	80 mm 250 m	8

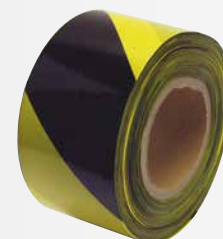

ПРЕДУПРЕДИТЕЛНА ЛЕНТА

№	Дължина	
38946	80 mm 250 m	8



ПРЕДУПРЕДИТЕЛНА ЛЕНТА, САМОЗАЛЕПВАЩА

№	Дължина	Характеристики	
38947	48 mm 33 m	pravá	48
38961	48 mm 33 m	levá	48



МАРКИРАЩА ЛЕНТА

№	Широчина	Дължина	Дебелина материалу	
38949	50 mm	50 m	0,15 mm	36

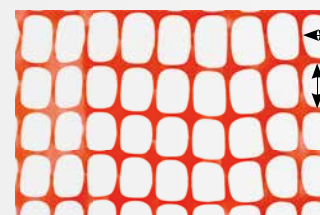

cca 3,5 cm

cca 6,5 cm

ОГРАДА ЗА СИГУРНОСТ

140 g/m² UV STABLE

№	Характеристики	
42190	1,2 x 50 m HDPE 140g/m ²	1



КОМПЛЕКТ PVC ЛЕНТИ

5x

№	Широчина	Дължина	Дебелина материалу	
38931	19 mm	5 m	0,13 mm	100



PVC ЛЕНТА, ЧЕРНА

№	Широчина	Дължина	Дебелина материалу	
38932	19 mm	10 m	0,13 mm	10



КОМПЛЕКТ PVC ЛЕНТИ

№	Широчина	Дължина	Дебелина материалу	
38925	19 mm	10 m	0,13 mm	10



PVC ЛЕНТА, ЧЕРНА

№	Широчина	Дължина	Дебелина материалу	
38968	19 mm	10 m	0,19 mm	10

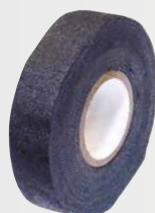

ТЕКСТИЛНА ЛЕНТА, ЧЕРНА

№	Широчина	Дължина	
38927	19 mm	10 m	10



ТЕКСТИЛНА ЛЕНТА ЗА КИЛИМИ И МОКЕТИ

№	Широчина	Дължина	
38980	48 mm	10 m	24
38981	48 mm	20 m	24



ПОДСИЛЕНА ДВОЙНОЗАЛЕПВАЩА ЛЕНТА

№	Широчина	Дължина	
38924	50 mm	10 m	1
38964	50 mm	25 m	1



ДВОЙНОЗАЛЕПВАЩА ЛЕНТА

PP Polypropylen			
№	Широчина	Дължина	
38929	50 mm	10 m	1
38966	50 mm	25 m	1



МОНТАЖНА, ДВОЙНОЗАЛЕПВАЩА ЛЕНТА

MADE IN EU			
№	Широчина	Дължина	
38990	19 mm	5 m	48
38991	25 mm	5 m	36



ПРОФЕСИОНАЛНА ЛЕНТА DUST TAPE

MADE IN EU			
№	Широчина	Дължина	
38995	48 mm	25 m	24



ПОДСИЛЕНА ЛЕНТА, ВОДОУСТОЙЧИВА

№	Широчина	Дължина	
38965	30 mm	10 m	1
38928	50 mm	10 m	72
38934	50 mm	45 m	24



БАНДАЖНА ЛЕНТА, PE

blue dolphin tapes MADE IN EU			
№	Широчина	Дължина	
37275	48 mm	50 m	24



БАНДАЖНА ФАСАДНА ЛЕНТА

blue dolphin tapes MADE IN EU UV STABLE			
№	Широчина	Дължина	
37271	38 mm	20 m	24
37270	48 mm	20 m	24
37272	48 mm	50 m	24

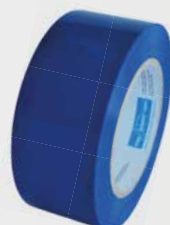

ПРЕДПАЗНА ЛЕНТА ЗА ПРОЗОРЦИ, PE

blue dolphin tapes MADE IN EU UV STABLE За 30 дни			
№	Широчина	Дължина	
37273	48 mm	50 m	24



МАСКИРАЩА ЛЕНТА, ХАРТИЕНА

blue dolphin tapes MADE IN EU			
№	Широчина	Дължина	
37263	38 mm	50 m	24
37264	48 mm	50 m	24

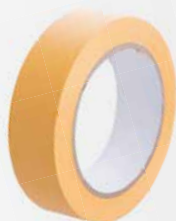

МАСКИРАЩА ЛЕНТА, PVC

MADE IN EU			
№	Широчина	Дължина	
37266	30 mm	33 m	60
37267	38 mm	33 m	48
37268	50 mm	33 m	36



ЛЕНТА, ХАРТИЕНА

MADE IN EU			
№	Широчина	Дължина	
37255	19 mm	50 m	12
37256	25 mm	50 m	12
37257	30 mm	50 m	7
37258	38 mm	50 m	6
37259	50 mm	50 m	6



ОПАКОВЪЧНА ЛЕНТА, PVC

MADE IN EU			
№	Широчина	Дължина	
38942	50 mm	50 m	72



ПОДПЛАТЕНИ С КОЛАНИ



№	Широчина	Дължина	
38972	50 mm	50 m	1
38973	50 mm	100 m	1

САМОЗАЛЕПВАЩА ЛЕНТА
АЛУМИНИЕВА

ALU

№	Широчина	Дължина	
38963	48 mm	10 m	1
38943	48 mm	45 m	24



ЛЕНТА ПРОТИВ ПРИПЛЪЗВАНЕ

№	Широчина	Дължина	Дебелина	
37280	25 mm	15 m	0,8 mm	72
37281	50 mm	15m	0,8 mm	36



САМОВУЛКАНИЗИРАЩА ЛЕНТА

№	Широчина	Дължина	
38930	19 mm	5 m	100

ЛЕНТА ЗА ГИПСКАРТОН,
ФИБРОСТЪКЛО

№	Широчина	Дължина	
38935	50 mm	20 m	60
38937	50 mm	45 m	36
38939	50 mm	90 m	24
38940	50 mm	153 m	24

ЛЕНТА ЗА ГИПСКАРТОН,
ФИБРОСТЪКЛО

№	Широчина	Дължина	
38941	50 mm	25 m	40

УПЛЪТНЯВАЩА ЛЕНТА,
ТЕФЛОНОВА

TEFLON

№	Широчина	Дължина	Дебелина	материалу	
38969	19 mm	15 m	0,2 mm		10

УПЛЪТНЯВАЩА ЛЕНТА,
ТЕФЛОНОВА

TEFLON

№	Широчина	Дължина	Дебелина	материалу	
38933	12 mm	10 m	0,075 mm		10

УПЛЪТНИТЕЛНА
КОРДА (ТЕФЛОНОВ КОНЕЦ)

· За ВиК и газови инсталации

TEFLON

№	Широчина	Дължина	
38926	2 mm	150 m	20

FESTA

NEW

УПЛЪТНИТЕЛНА
КОРДА
(ТЕФЛОНОВ КОНЕЦ)

· 160m
· -20°C ... +130°C
· max 16 bar



№	Характеристики	
38975		1

ДИСПАНСЕР ЗА
ОПАКОВЪЧНА ЛЕНТА

№	
38985	1



ВЕЛКРО ЛЕНТА

№	Характеристики	
45471	12 mm x 5 m	1



FESTA

ВЕЛКРО ЛЕНТА, 3 БРОЯ

3x

№	Широчина	Дължина	
37295	20 mm	150 mm	1
37296	20 mm	200 mm	1
37297	20 mm	250 mm	1

ВИНТОВ
ОБТЕГАЧ

DIN 1480 Zn

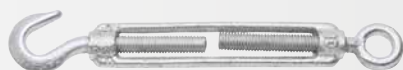

№	Характеристики	
50100	5 x 70 mm	10
50101	6 x 90 mm	10
50102	8 x 125 mm	10
50103	10 x 150 mm	10

№	Характеристики	
50104	12 x 200 mm	10
50106	16 x 230 mm	10
50108	20 x 220 mm	10

КАРАБИНЕР

DIN 5299 C Zn



№	Характеристики	
51204	4 mm	10
51205	5 mm	10
51206	6 mm	10
51207	7 mm	10
51208	8 mm	10

№	Характеристики	
51209	9 mm	10
51210	10 mm	10
51211	11 mm	10
51212	12 mm	10

КАРАБИНЕР С МУФА

Zn



№	Характеристики	
51241	4 mm	10
51242	5 mm	10
51243	6 mm	10
51244	7 mm	10

№	Характеристики	
51245	8 mm	10
51246	10 mm	10
51247	12 mm	10

S-ОБРАЗНА КУКА

Zn



№	Характеристики	
51271	3 mm	10
51272	4 mm	10
51273	5 mm	10
51274	6 mm	10

№	Характеристики	
51275	7 mm	10
51276	8 mm	10
51278	10 mm	10

РИНГ ГАЙКА

DIN 5820 Zn



№	Характеристики	
51320	6 mm	10
51321	8 mm	10
51322	10 mm	10
51323	12 mm	10

№	Характеристики	
51324	14 mm	10
51325	16 mm	10
51327	20 mm	10

БОЛТ С УХО

DIN 5820 Zn



№	Характеристики	
51300	6 mm	10
51301	8 mm	10
51302	10 mm	10
51303	12 mm	10
51304	14 mm	10

№	Характеристики	
51305	16 mm	10
51306	18 mm	10
51307	20 mm	10
51308	22 mm	10



ВЪРТЯЩ СЕ КАРАБИНЕР

Zn

№	Характеристики	
51220	53 mm	10
51221	67 mm	10
51222	76 mm	10



ВЪРТЯЩ СЕ КЛИПС ЗА ВЪЖЕ

Zn

№	Характеристики	
51225	3,8 mm	10
51226	4,5 mm	10
51227	6,0 mm	10

КОНЕКТОР ЗА ВЪЖЕТА И КАБЕЛИ,
ЕДИНИЧЕН, ПОЦИНКОВАН

DIN 5685 C Zn

№	Характеристики	
51341	Ø 10 mm	10



КЛИПС ЗА ВЪЖЕ

Zn

No.	specification	
51280	3 mm	10
51281	5 mm	10
51282	6 mm	10
51283	8 mm	10
51284	10 mm	10
51286	12 mm	10
51287	14 mm	10
51288	16 mm	10



КАУШ ЗА ВЪЖЕ

Zn

№	Характеристики	
51258	Ø 16 mm	10
51259	Ø 18 mm	10
51260	Ø 20 mm	10
51261	Ø 22 mm	10
51262	Ø 24 mm	10
51264	Ø 28 mm	10

ВЕРИЖНА ЛЕБЕДКА



№	Товароподемност	Мин. височина	Повдигане	Брой ролки	Дебелина на веригата	Тегло	
26700	500 kg	280 mm	3 000 mm	1	6 mm	7,5 kg	1
26701	1 000 kg	300 mm	3 000 mm	1	6 mm	9 kg	1
26702	2 000 kg	380 mm	3 000 mm	2	6 mm	12 kg	1

ИНСТРУМЕНТ ЗА ОБТЯГАНЕ



№	Характеристики	
50035	2 t	6
50036	4 t	4

ВЕРИГА С КЪСО ЗВЕНО, ПОЦИНКОВАНА

DIN 5685 A Zn



№	Око	Дължина		№	Око	Дължина	
51402	2 x 10 mm	110 m	1	51406	6 x 24 mm	18 m	1
51403	3 x 16 mm	60 m	1	51407	7 x 50 mm	16 m	1
51404	4 x 21 mm	40 m	1	51408	8 x 32 mm	10 m	1
51405	5 x 23 mm	30 m	1	51410	10 x 39 mm	10 m	1

ВЕРИГА С КЪСО ЗВЕНО, ПОЦИНКОВАНА

DIN 5686 Zn



№	Ø	Дължина		№	Ø	Дължина	
51430	1,4 mm	150 m	1	51433	2,0 mm	118 m	1
51431	1,6 mm	150 m	1	51435	2,5 mm	70 m	1
51432	1,8 mm	130 m	1	51436	2,8 mm	50 m	1

ВЕРИГА С ДЪЛГО ЗВЕНО, ПОЦИНКОВАНА

DIN 5685 C Zn



№	Око	Дължина		№	Око	Дължина	
51412	2 x 12 mm	80 m	1	51416	6 x 43 mm	18 m	1
51413	3 x 26 mm	60 m	1	51417	7 x 50 mm	16 m	1
51414	4 x 32 mm	38 m	1	51418	8 x 54 mm	10 m	1
51415	5 x 35 mm	32 m	1	51420	10 x 65 mm	10 m	1

ВЕРИГА



№	Характеристики	
51450	6 mm 25 m Червена-бяла	1

ЛЕБЕДКА С ВЪЖЕ И КУКА

Zn



№	Товароносимост	Дължина лапа	
26720	300 kg	8 m	1
26705	450 kg	8 m	1
26721	500 kg	8 m	1
26722	800 kg	8 m	1
26706	900 kg	8 m	1
26707	1350 kg	8 m	1

СТЕЛАЖ ЗА ВЪЖЕТА, СТЕЛАЖ ЗА ВЕРИГИ



№	Характеристики	
51196	Стелаж за вериги, с артикули	10
51197	Стелаж за въжета, с артикули	10
51198	Стелаж за вериги	10
51199	Стелаж за въжета	10

ВЪЖЕ, ПОЦИНКОВАНО

Zn



№	Ø на въжето	Дължина	
51100	Ø 1 mm	500 m	1
51102	Ø 1,5 mm	500 m	1
51103	Ø 2 mm	200 m	1
51104	Ø 3 mm	200 m	1
51105	Ø 4 mm	100 m	1
51106	Ø 5 mm	75 m	1
51107	Ø 6 mm	75 m	1
51130	Ø 8 mm	75 m	1
51131	Ø 10 mm	50 m	1
51132	Ø 12 mm	50 m	1

ВЪЖЕ, ПОЦИНКОВАНО, С PVC ОБВИВКА

Zn



№	Ø на въжето	Дължина	
51108	Ø 2/3 mm	200 m	1
51109	Ø 3/4 mm	100 m	1
51110	Ø 4/5 mm	75 m	1
51111	Ø 5/6 mm	50 m	1

ВЪЖЕ ОТ НЕРЪЖДАЕМА СТОМАНА

INOX



№	Ø на въжето	Дължина	
51120	Ø 1 mm	300 m	1
51121	Ø 1,2 mm	300 m	1
51122	Ø 1,5 mm	300 m	1
51123	Ø 2 mm	200 m	1
51124	Ø 3 mm	200 m	1
51125	Ø 4 mm	100 m	1
51126	Ø 5 mm	75 m	1
51127	Ø 6 mm	75 m	1

РЕЗБОВАН ПРЪТ

DIN 975 **Zn**

4.8 · Клас на якості

№	Характеристики	
55040	M 4 1 m	200
55050	M 5 1 m	150
55060	M 6 1 m	100
55080	M 8 1 m	50
55100	M 10 1 m	20
55120	M 12 1 m	20
55140	M 14 1 m	15
55160	M 16 1 m	15
55180	M 18 1 m	10
55200	M 20 1 m	10
55220	M 22 1 m	5
55240	M 24 1 m	5
55300	M 30 1 m	5

РЕЗБОВАН ПРЪТ, НЕРЪЖДАЕМА СТОМАНА

DIN 976 **INOX** **4.8** · Клас на якості

№	Характеристики	
55315	M 12 1 m	20
55316	M 14 1 m	15
55317	M 16 1 m	15
55318	M 18 1 m	10
55319	M 20 1 m	10

before after



РЕЗБОВАН ПРЪТ

DIN 975 **4.8** · Клас на якості

№	Характеристики	
55051	M 5 1 m	150
55181	M 18 1 m	10
55201	M 20 1 m	10
55221	M 22 1 m	5

FESTA

ПОЧИСТВАЩ ПРЕПАРАТ ЗА РЪБОВЕ

Ø 3 - 19 mm

1/4"

№	Характеристики	
16321		5



ГАЙКИ, ШЕСТОСТЕННИ

DIN 934 **Zn**

4.8 · Клас на якості

№	Характеристики	
55350	M 4 100 бр.	1
55351	M 5 100 бр.	1
55352	M 6 100 бр.	1
55353	M 8 100 бр.	1
55354	M 10 100 бр.	1
55355	M 12 100 бр.	1
55356	M 14 100 бр.	1
55357	M 16 100 бр.	1
55358	M 18 100 бр.	1
55359	M 20 10 бр.	1
55360	M 22 10 бр.	1
55361	M 24 10 бр.	1
55362	M 30 10 бр.	1



ШАЙБИ

DIN 440R **Zn**



№	Характеристики	
55331	M 5 100 бр.	1
55332	M 6 100 бр.	1
55333	M 8 100 бр.	1
55334	M 10 100 бр.	1
55335	M 12 100 бр.	1
55336	M 14 100 бр.	1
55337	M 16 100 бр.	1
55339	M 20 10 бр.	1
55340	M 22 10 бр.	1
55341	M 24 10 бр.	1
55342	M 30 10 бр.	1



FESTA

ОРГАНАЙЗЕР КУТИЯ



№	Характеристики	
55650	375 x 290 x 67 mm	1



ВИНТОВЕ ЗА ДЪРВО

2000x

№	Характеристики	
55640	2000 бр.	1



Броя	
350	3,0 x 16 mm
280	3,0 x 20 mm
220	3,0 x 25 mm
250	3,5 x 20 mm
240	3,5 x 25 mm
180	3,5 x 3, mm
280	4,0 x 16 mm
80	4,0 x 30 mm
40	4,0 x 40 mm
30	4,0 x 50 mm
25	5,0 x 50 mm
25	5,0 x 60 mm

ВИНТОВЕ ЗА ДЪРВО + ДЮБЕЛИ

винтове за дърво

Броя	
40	3,5 x 30 mm
25	4,0 x 40 mm
12	5,0 x 50 mm
8	6,0 x 60 mm

дюбели

Броя	
40	5 x 25 mm
25	6 x 30 mm
12	8 x 40 mm
8	10 x 50 mm

170x

№	Характеристики	
55645		1



ВИНТОВЕ ЗА ДЪРВО

Броя	
60	3,0 x 12 mm
50	3,0 x 16 mm
40	3,0 x 20 mm
50	3,5 x 20 mm
40	3,5 x 30 mm
25	4,0 x 30 mm
20	4,0 x 40 mm
15	5,0 x 50 mm
10	5,0 x 60 mm

310x

№	Характеристики	
55642		1





ЗАЩИТНИ ОЧИЛА

CE EN
166

№	Характеристики	
50510		10



ЗАЩИТНИ ОЧИЛА

CE EN
166

№	Характеристики	
50514		10



ЗАЩИТНИ ОЧИЛА

Регулируеми

CE EN
166

№	Характеристики	
50511		12



ЗАЩИТНИ ОЧИЛА

CE EN
170

№	Характеристики	
50512	Със затъмнение	12



ЗАЩИТНИ ОЧИЛА

CE EN
166

№	Характеристики	
50513		1



ЗАЩИТНИ СЛУШАЛКИ

CE EN
35227
dB

№	Характеристики	
50563		1



ЗАЩИТНИ СЛУШАЛКИ

CE EN
35227
dB

№	Характеристики	
50564		1

ЗАЩИТНА МАСКА
ЗА ЛИЦЕCE EN
166

№	Характеристики	
50556		10

ЗАЩИТНА МАСКА,
С МРЕЖАCE
EN 1731

№	Характеристики	
50562		10



ТАПИ ЗА УШИ

№	Характеристики	
50560		100



ТАПИ ЗА УШИ С ШНУР

№	Характеристики	
50559		100



РАБОТНА КАСКА, CLIMAX

CE EN
397MADE IN
EU

№	Характеристики	
50550	Синя	30
50551	Червена	30
50553	Бяла	30
50554	Жълта	30



ОТРАЗИТЕЛНА ЖИЛЕТКА

CE EN
20471

№	Характеристики	
50570	Оранжева	100
50571	Жълта	100



ПОДЛОЖКА ЗА КОЛЕНЕ

№	Характеристики	
37135		1



FESTA

ПРОТЕКТОР ЗА КОЛЕНЕ

№	Характеристики	
37145	С гел	8



FESTA

ПРОТЕКТОР ЗА КОЛЕНЕ

№	Характеристики	
37140	С гел	12



FESTA

ПРОТЕКТОР ЗА КОЛЕНЕ

№	Характеристики	
37144	С гел	12



FESTA

ПРОТЕКТОР ЗА КОЛЕНЕ

№	Характеристики	
37143		12



FESTA

ПРОТЕКТОР ЗА КОЛЕНЕ

№	Характеристики	
37142	komfort	20



ПРОТЕКТОР ЗА КОЛЕНЕ

№	Характеристики	
37139	Неорен	10



ПРОТЕКТОР ЗА КОЛЕНЕ

№	Характеристики	
37141		6





КОЖЕНИ РЪКАВИЦИ, ПОДСИЛЕНИ

· Подсилени длани



№	Характеристики	
50518	Размер 11"	12



КОЖЕНИ РЪКАВИЦИ, ПОДСИЛЕНИ

· Подсилени длани



№	Характеристики	
50519	Размер 10,5"	12



КОЖЕНИ РЪКАВИЦИ



№	Характеристики	
50520	Размер 10,5"	12



ПАМУЧНИ РЪКАВИЦИ С PVC ТОЧКИ

№	Характеристики	
50524	Размер 10"	12



ПАМУЧНИ РЪКАВИЦИ С PVC ПОКРИТИЕ



№	Характеристики	
50525	Размер 10" - дължина 35 cm	12



ПОЛИЕСТЕРНИ РЪКАВИЦИ С PVC ТОЧКИ

· С PVC точки

№	Характеристики	
50526	Размер 10"	12



ПАМУЧНИ РЪКАВИЦИ С ЛАТЕКСОВО ПОКРИТИЕ



№	Характеристики	
50522	Размер 10"	12



НАЙЛОНОВИ РЪКАВИЦИ С НИТРИЛ ПОКРИТИЕ



№	Характеристики	
50533	Размер 10"	12



РЪКАВИЦИ С ПОКРИТИЕ ОТ ЛАТЕКС ПЯНА



№	Характеристики	
50535	Размер 8"	12
50536	Размер 9"	12
50537	Размер 10"	12



РЪКАВИЦИ С ПОКРИТИЕ ОТ НИТРИЛ ПЯНА

· С PVC точки



№	Характеристики	
50539	Размер 10"	12



РЪКАВИЦИ ОТ АКТИЛ С ЛАТЕКСОВО ПОКРИТИЕ



№	Характеристики	
50529	Размер 10"	12



ГРАДИНСКИ РЪКАВИЦИ



№	Характеристики	
50557	Размер 7"	12
50558	Размер 8"	12
50549	Размер 9"	12



ПАМУЧНИ РЪКАВИЦИ

· С PVC точки

№	Характеристики	
50531	Размер 9"	12



РАБОТНИ РЪКАВИЦИ ОТ КОЗЯ КОЖА

№	Характеристики	
50541	Размер 9"	12
50542	Размер 10"	12



РАБОТНИ РЪКАВИЦИ ОТ СВИНСКА КОЖА

№	Характеристики	
50544	Размер 10"	12



РЪКАВИЦИ С ПОЛИУРЕТАНОВО ПОКРИТИЕ



№	Характеристики	
50527	Размер 10"	12



ЗАВАРЪЧНИ РЪКАВИЦИ, КОЖЕНИ



№	Характеристики	
50540	Размер 11"	12



ВИНИЛОВИ РЪКАВИЦИ ЗА ЕДН. УПОТРЕБА

· бистър, без прах



№	Характеристики	
50532	Размер 9"	100



РЕСПИРАТОР



№	Характеристики	
50500	FFP2 без вентил	30



РЕСПИРАТОР



№	Характеристики	
50503	FFP2 с вентил	20



ЗАЩИТНО ОБЛЕКЛО С КАЧУЛКА

№	Характеристики	
50585	Размер M	1
50586	Размер L	1
50587	Размер XL	1
50588	Размер XXL	1



ЗАВАРЪЧНА ПРЕСТИЛКА

№	Характеристики	
50555	Кожа	1



**FESTO**

ЧАНТА ЗА ИНСТРУМЕНТИ С МЕТАЛНА ДРЪЖКА

№	Височина	Дължина	дубина	
37331	280 mm	490 mm	230 mm	2

**FESTO**

РАБОТНА ЧАНТА

№	Широчина	Височина	дубина	
37332	480 mm	290 mm	250 mm	1

FESTO

РАБОТНА ЧАНТА

№	Широчина	Височина	дубина	
37330	610 mm	400 mm	270 mm	5

**FESTO**

КАЛЪФ ЗА ИНСТРУМЕНТИ

Подсилени джобове



№	Характеристики	
37325		10

FESTO

КАЛЪФ ЗА ИНСТРУМЕНТИ

Подсилени джобове



№	Характеристики	
37326		12

**FESTO**

РАБОТЕН КОЛАН

№	Характеристики	
37328	145 cm	20



FESTA

РАБОТЕН КОЛАН



№	Дължина	Широчина	
37310	120 cm	6 cm	1

FESTA

РАБОТЕН КОЛАН,
КОМПЛЕКТ

· 14 джоба + око



№	Дължина	Широчина	
37311	120 cm	6 cm	1



FESTA

КАЛЪФ ЗА ИНСТРУМЕНТИ

· 8 джоба



№	Широчина	Височина	
37320	300 mm	250 mm	1

FESTA

КАЛЪФ ЗА ИНСТРУМЕНТИ

· 4 джоба



№	Широчина	Височина	
37321	350 mm	300 mm	1

FESTA

РАБОТНО ЯКЕ



№	Характеристики	
37350		20



FESTA

РАБОТЕН КОЛАН, КОЖЕН



№	Характеристики	
37302	6 джоба	50
37303	11 джоба	25



РАБОТЕН КОЛАН, КОЖЕН



№	Характеристики	
37300	6 джоба	50
37301	11 джоба	25



FESTA



РАБОТНА ЧАНТА, КОЖЕНА



№	Височина	Дължина	Глоубка	
37342	270 mm	430 mm	180 mm	1



ЕЛЕКТРИЧАРСКА ЧАНТА, КОЖЕНА



№	Височина	Дължина	Глоубка	
37341	260 mm	430 mm	200 mm	1



РАБОТНА ЧАНТА С ПОДСИЛЕНО ДЪНО, КОЖЕНА



№	Височина	Дължина	Глоубка	
37340	240 mm	430 mm	150 mm	1



ЗАНАЯТЧИЙСКА ЧАНТА С КАИШКА, КОЖЕНА

№	Височина	Дължина	Глоубка	
37344	250 mm	300 mm	130 mm	1



РАБОТНА ЧАНТА С ПОДСИЛЕНО ДЪНО

№	Височина	Дължина	Глоубка	
37343	240 mm	430 mm	150 mm	1



ЕЛЕКТРИЧАРСКА ЧАНТА

№	Височина	Дължина	Глоубка	
37345	270 mm	430 mm	180 mm	1

ЗАКОПЧАЛКА ЗА РАБОТЕН КОЛАН, КОЖЕНА



№	Характеристики
37308	20



ЗАКОПЧАЛКА ЗА РАБОТЕН КОЛАН, КОЖЕНА



№	Характеристики
37309	20





FESTA

СЕКРЕТЕН ПАТРОН,
МЕСИНГ



№	Характеристики	
23001	65 mm · 175 g	10



СЕКРЕТЕН ПАТРОН,
МЕСИНГ



№	Характеристики	
23000	65 mm · 75 g	15



FESTA

ПОДСИЛЕН КАТИНАР



№	Характеристики	
23261	25 mm	6
23262	32 mm	12
23263	38 mm	6
23264	45 mm	6
23265	52 mm	12
23266	63 mm	6



FESTA

ПОДСИЛЕН КАТИНАР,
МЕСИНГ



№	Характеристики	
23125	25 mm	12
23130	30 mm	12
23135	35 mm	12
23140	40 mm	12
23150	50 mm	12
23160	60 mm	12



FESTA

МЕСИНГОВ КАТИНАР
С PVC ПОКРИТИЕ



№	Характеристики	
23310	30 mm	10
23311	40 mm	10
23312	50 mm	6



FESTA

ПОДСИЛЕН КАТИНАР,
УДЪЛЖЕН



№	Характеристики	
23211	25 mm	12
23212	32 mm	12
23213	38 mm	6
23214	45 mm	6
23215	52 mm	6



FESTA

ПОДСИЛЕН КАТИНАР,
МЕСИНГ



№	Характеристики	
23274	60 mm	6
23275	70 mm	12

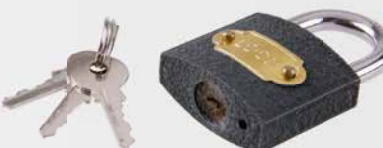

ПОДСИЛЕН КАТИНАР



№	Характеристики	
23220	25 mm	6
23225	30 mm	6
23232	32 mm	6
23240	40 mm	6
23250	50 mm	6
23260	60 mm	6



КАТИНАР, МЕСИНГ



№	Характеристики	
23020	20 mm	12
23025	25 mm	12
23030	30 mm	12
23035	35 mm	12
23040	40 mm	12
23050	50 mm	12
23060	60 mm	12





КАТИНАР, МЕСИНГ,
УДЪЛЖЕН



№	Характеристики	
23070	40 mm	12

ПОДСИЛЕН
КАТИНАР



№	Характеристики	
23010	50 mm	6

ПОДСИЛЕН
КАТИНАР,
ВЛАГОУСТОЙЧИВ



№	Характеристики	
23005	40 mm	6
23006	50 mm	6



FESTA

КАТИНАР ЗА КОЛЕЛО
С ЦИФРОВ КОД



№	Характеристики	
23288	120 cm x Ø 10 mm	1



FESTA

КАТИНАР ЗА КОЛЕЛО
С ЦИФРОВ КОД



№	Характеристики	
23287	65 cm x Ø 10 mm	1



FESTA

КАТИНАР ЗА КОЛЕЛО



№	Характеристики	
23290	120 cm x Ø 8 mm	1
23291	150 cm x Ø 8 mm	1
23292	180 cm x Ø 8 mm	1

КАТИНАР ЗА КОЛЕЛО



№	Характеристики	
23282	55 cm x Ø 8 mm	50
23284	65 cm x Ø 8 mm	50



КАТИНАР
С ЦИФРОВ КОД



№	Характеристики	
23281		20





FESTA

**СЕЙФ
С ЕЛЕКТРОННА КЛЮЧАЛКА**



- Тип заключване: електронно, механично
- Ключ за защита
- Размери 350x250x250мм
- Тегло 10кг



№	Характеристики	Икон
23270		1

FESTA

ЕТИКЕТИ ЗА КЛЮЧОВЕ



- Подсилен пръстен



№	Икон
23391	50

ЕТИКЕТИ ЗА КЛЮЧОВЕ



№	Икон
23390	1



ПАНТА С ЧУПЕЦО РАМО

№	Характеристики	Икон
51514	100 mm	25
51515	120 mm	25
51516	140 mm	25
51517	160 mm	25



РЕЗЕ

№	Характеристики	Икон
51510	100 mm	12
51511	120 mm	12
51512	140 mm	12
51513	160 mm	12



КАСА ЗА КЛЮЧОВЕ



№	Характеристики	Икон
70140	250 x 180 x 80 mm - за 48 ключа	12
70141	300 x 230 x 90 mm - за 90 ключа	8

КАСА ЗА ПАРИ



№	Широчина	Дълбочина	Височина	Икон
70120	125 mm	95 mm	60 mm	1



КАСА ЗА ПАРИ



№	Широчина	Дълбочина	Височина	Икон
70121	152 mm	118 mm	80 mm	36



КАСА ЗА ПАРИ



№	Широчина	Дълбочина	Височина	Икон
70122	200 mm	160 mm	90 mm	20



КАСА ЗА ПАРИ



№	Широчина	Дълбочина	Височина	Икон
70123	250 mm	180 mm	90 mm	16





КАСА ЗА ПАРИ



№	Широчина	Дълбочина	Височина	
70124	300 mm	240 mm	90 mm	10



КАСА ЗА ПАРИ



№	Широчина	Дълбочина	Височина	
70125	370 mm	280 mm	90 mm	8



ПОЩЕНСКА КУТИЯ



№	Цвят	Широчина	Височина	Дълбочина	
70101	Бяла	290 mm	360 mm	105 mm	5
70100	Кафява	290 mm	360 mm	105 mm	5



ПОЩЕНСКА КУТИЯ



№	Цвят	Широчина	Височина	Дълбочина	
70102	Бяла	310 mm	260 mm	90 mm	10
70103	Кафява	310 mm	260 mm	90 mm	10



ПОЩЕНСКА КУТИЯ



№	Цвят	Широчина	Височина	Дълбочина	
70105	Кафява	310 mm	360 mm	90 mm	5



ПОЩЕНСКА КУТИЯ



№	Цвят	Широчина	Дълбочина	Височина	
70108	Бяла	370 mm	134 mm	364 mm	5

ПОЩЕНСКА КУТИЯ,
НЕРЪЖДАЕМА СТИМАНА

№	Широчина	Дълбочина	Височина		
70107	Stainless	360 mm	100 mm	520 mm	6

ПОЩЕНСКА КУТИЯ,
НЕРЪЖДАЕМА СТИМАНА

№	Широчина	Дълбочина	Височина		
70106	Stainless	360 mm	100 mm	360 mm	5

ПОЩЕНСКА КУТИЯ,
НЕРЪЖДАЕМА СТИМАНА

№	Широчина	Дълбочина	Височина		
70109	Stainless	310 mm	90 mm	260 mm	6

ПОЩЕНСКА КУТИЯ,
НЕРЪЖДАЕМА СТИМАНА

№	Широчина	Дълбочина	Височина		
70110	Stainless	310 mm	90 mm	360 mm	6

РЪЧЕН КАНТАР, АНАЛОГОВ

№	Товароподемност		
24260	50 kg	10	



РЪЧЕН КАНТАР

№	Товароподемност	
24212	12,5 kg	12
24225	25 kg	6
24250	50 kg	6
24255	100 kg	6
24258	150 kg	6



ПИНСЕТИ С LED СВЕТЛИНА

№	Характеристики	
50005	95 mm	8



КОМПЛЕКТ ПИНСЕТИ, НЕРЪЖДАЕМА СТОМАНА

№	Характеристики	
50004		1

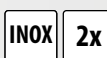

КАПАН ЗА МИШКИ

№	Характеристики	
70221	90 x 45 mm Дървен	1



КАПАН ЗА МИШКИ

№	Характеристики	
70220	97 x 47 mm Пластмасов	48



СПИРАЛА ЗА ОТПУШВАНЕ НА КАНАЛИ

възможност за използване с бормашина

№	Дължина	Ø	
50014	6 m	6 mm	6



Ø 15 mm



СПИРАЛА ЗА ОТПУШВАНЕ НА КАНАЛИ С С-ОБРАЗЕН ВРЪХ

№	Дължина	
50010	3 m	10
50011	5 m	5
50012	10 m	3
50013	15 m	4



Ø 20mm



СПИРАЛА ЗА ОТПУШВАНЕ НА КАНАЛИ

№	Дължина	Ø	
50009	3 m	5 mm	40



Ø 5mm



ПОМПА ЗА ОТПУШВАНЕ НА КАНАЛИ

№	Дължина	Ø	
50015	385 mm	65 mm	30



ЖИЛО ЗА ИЗТЕГЛЯНЕ НА КАБЕЛ

№	Дължина	Ø	
51181	8 m	5 mm	25
51182	10 m	5 mm	25

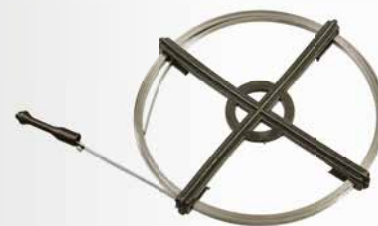



244

МИСТРИИ И МАЛАМАШКИ ЗА ШПАКЛОВКА



250

КАНЧОЦИ



254

РЕНДЕТА ЗА МАЗИЛКИ И ИЗОЛАЦИЯ



255

МАЛАМАШКИ И ШКУРКИ



257

ПЕРДАШКИ

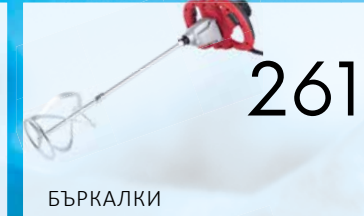

261

БЪРКАЛКИ

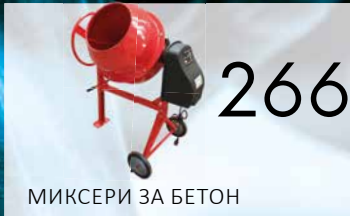

266

МИКСЕРИ ЗА БЕТОН



269

УЛЕИ ЗА СТРОИТЕЛНИ ОТПАДЪЦИ



269

РЪЧНИ КОЛИЧКИ



270

НИВЕЛИРИ HORIZONT



272

СКОБИ ЗА КАМЕННИ БЛОКОВЕ



274

МАШИНИ ЗА РЯЗАНЕ НА ПЛОЧКИ



277

ИНСТРУМЕНТИ ЗА ПОЛАГАНЕ НА ПЛОЧКИ



280

НИВЕЛИРАЩИ АКСЕСОАРИ



286

ЕЛЕКТРИЧЕСКИ НОЖ ЗА ПОЛИСТИРЕН



292

ИНСТРУМЕНТИ ЗА ГИПСОКАРТОН



294

РВ НАГРЕВАТЕЛИ И РЕГУЛАТОРИ НА НАЛЯГАНЕТО



296

КОФИ И ВАНИ



297

ПИСТОЛЕТИ ЗА УПЛЪТНИТЕЛИ



299

ПИСТОЛЕТИ ЗА ПОЛИУРЕТАНОВА ПЯНА



300

ИНСТРУМЕНТИ ЗА БОЯДИСВАНЕ



305

БРЕЗЕНТИ



306

СТЪЛБА



307

ВРАТИЧКИ ЗА КОМИНИ И КОФРАЖ

СТРОИТЕЛНИ
ИНСТРУМЕНТИ

242 - 307





FESTO

FESTO

МАЛАМАШКА ОТ
НЕРЪЖДАЕМА
СТОМАНА,
280 X 130 MM

· Гумирана дръжка



№	Характеристики	
31140	Прав	10

FESTO

МАЛАМАШКА ОТ
НЕРЪЖДАЕМА
СТОМАНА,
280 X 130 MM

· Гумирана дръжка



№	Характеристики	
31148	Прав	10

FESTO

НАЗЪБЕНА МАЛАМАШКА
ОТ НЕРЪЖДАЕМА
СТОМАНА,
280 X 130 MM

· Гумирана дръжка



№	Характеристики	
31146	О 16	10

FESTO

НАЗЪБЕНА МАЛАМАШКА
ОТ НЕРЪЖДАЕМА
СТОМАНА,
280 X 130 MM

· Гумирана дръжка



№	Характеристики	
31141	е 4	10
31142	е 6	10
31143	е 8	10
31144	е 10	10
31145	е 12	10

FESTO

МАЛАМАШКА, НЕРЪЖ-
ДАЕМА СТОМАНА,
НАЗЪБЕНА,
280 X 130 MM



№	Характеристики	
31101	е 4	10
31111	е 6	10
31121	е 8	10
31131	е 10	10
31132	е 12	10

FESTO

МАЛАМАШКА ОТ
НЕРЪЖДАЕМА
СТОМАНА,
280 X 130 MM



№	Характеристики	
31091	Прав	10

FESTA

МАЛАМАШКА ОТ
НЕРЪЖДАЕМА
СТОМАНА,
280 X 130 MM



№	Характеристики	
31011	Права	10

FESTA

НАЗЪБЕНА МАЛАМАШКА
ОТ НЕРЪЖДАЕМА
СТОМАНА
280 X 130 MM



№	Характеристики	
31021	е 4	10
31031	е 6	10
31041	е 8	10

МАЛАМАШКА,
INOX,
270 X 125 MM



№	Характеристики	
31005	Права	25

НАЗЪБЕНА
МАЛАМАШКА,
INOX,
270 X 125 MM



№	Характеристики	
31006	е 4	24
31007	е 6	24

FESTA

МАЛАМАШКА,
INOX,
360 X 130 MM



№	Характеристики	
31151	Права	10

FESTA

МАЛАМАШКА ОТ
НЕРЪЖДАЕМА
СТОМАНА
360 X 130 MM



№	Характеристики	
31150	Права	10

FESTA

МАЛАМАШКА ОТ
НЕРЪЖДАЕМА
СТОМАНА
480 X 130 MM



№	Характеристики	
31082	Права	10

FESTA

МАЛАМАШКА ОТ
НЕРЪЖДАЕМА
СТОМАНА
680 X 130 MM



№	Характеристики	
31155	Права	10

FESTA

МАЛАМАШКА ОТ НЕРЪЖ-
ДАЕМА СТОМАНА,
НАЗЪБЕНА
500 X 130 MM



№	Характеристики	
31052	е 4	10
31061	е 6	10
31062	е 8	10
31071	е 10	10
31072	е 12	10

FESTA

МАЛАМАШКА ОТ
НЕРЪЖДАЕМА
СТОМАНА
500 X 130 MM



№	Характеристики	
31081	Права	10



FESTAТРАПЕЦОВИДНА
МИСТРИЯ, INOX

INOX · Гумирана дръжка

№	Характеристики	
31232	120 mm	10
31233	140 mm	10

**FESTA**ТРАПЕЦОВИДНА
МИСТРИЯ, INOX

INOX

№	Характеристики	
31220	120 x 80 mm	10
31221	140 x 80 mm	10

**FESTA**МИСТРИЯ СЪС
ЗАОБЛЕН ВРЪХ, INOX

INOX · Гумирана дръжка

№	Характеристики	
31334	160 x 100 mm	10

**FESTA**МИСТРИЯ СЪС
ЗАОБЛЕН ВРЪХ

INOX

№	Характеристики	
31343	160 x 100 mm	10

**FESTA**

ПРАВА МИСТРИЯ, INOX

INOX · Гумирана дръжка

№	Характеристики	
31360	40 mm	10
31380	60 mm	10
31390	80 mm	10

**FESTA**

ПРАВА МИСТРИЯ, INOX

INOX

№	Характеристики	
31362	40 mm	10
31382	60 mm	10

**FESTA**МИСТРИЯ СЪС
ЗАОБЛЕН ВРЪХ, INOX

INOX · Гумирана дръжка

№	Характеристики	
31330	140 x 50 mm	10
31340	160 x 60 mm	10

**FESTA**МИСТРИЯ СЪС
ЗАОБЛЕН ВРЪХ, INOX

INOX

№	Характеристики	
31332	140 x 50 mm	10
31341	160 x 60 mm	10

**FESTA**МИСТРИЯ С ВЪТРЕШЕН
ЪГЪЛ, INOX

INOX · Гумирана дръжка

№	Характеристики	
31280	80 x 60 x 60 mm	10

**FESTA**МИСТРИЯ С ВЪТРЕШЕН
ЪГЪЛ, INOX

INOX

№	Характеристики	
31281	80 x 60 x 60 mm	10

**FESTA**МИСТРИЯ С ВЪНШЕН
ЪГЪЛ, INOX

INOX · Гумирана дръжка

№	Характеристики	
31270	80 x 60 x 60 mm	10

**FESTA**МИСТРИЯ С ВЪТРЕШЕН
ЪГЪЛ, INOX

INOX

№	Характеристики	
31271	80 x 60 x 60 mm	10



FESTA

ТРИЪГЪЛНА МИСТРИЯ,
INOX

INOX · Гумирана дръжка

№	Характеристики	
31320	140 x 75 mm	10



FESTA

ТРИЪГЪЛНА МИСТРИЯ,
INOX

INOX

№	Характеристики	
31322	140 x 75 mm	10



FESTA

МИСТРИЯ,
НАЗЪБЕНА,
INOX

INOX

№	Характеристики	
31218	180 mm e 6	12



FESTA

ШПАКЛА, НЕРЪЖ-
ДАЕМА СТОМАНА

· Гумирана дръжка

INOX

№	Характеристики	
31510	40 mm	10
31511	60 mm	10
31512	80 mm	10



FESTA

СКРАБКА СЪС
ЗАОСТРЕНО ОСТРИЕ

· Гумирана дръжка
· дебело острие

INOX

№	Характеристики	
32173	75 mm	10



FESTA

СКРАБКА СЪС
ЗАОСТРЕНО ОСТРИЕ

· Препоръчва се с дръжка 52010
· Дебело острие

INOX

№	Характеристики	
32170	100 mm	12



FESTA

ШПАКЛА С БИТ,
НЕРЪЖДАЕМА
СТОМАНА

· Гумирана дръжка

INOX

№	Характеристики	
31455	150 mm	12
31456	200 mm	12



FESTA

ШПАКЛА, НЕРЪЖ-
ДАЕМА СТОМАНА

INOX

№	Характеристики	
31517		10



FESTA

ФАСАДНА
ШПАКЛА

· Гумирана дръжка

INOX

№	Характеристики	
31505	200 mm	5
31506	250 mm	5
31507	300 mm	5



**FESTA**

СКРАБКА СЪС ЗАОСТРЕНО ОСТРИЕ

· Дебело острие

INOX

№	Широчина	Дължина	
32174	100 mm	500 mm	1

FESTA

ШПАКЛА, НЕРЪЖДАЕМА СТОМАНА

INOX

R.s.	leirás	
31461	40 mm	12
31471	60 mm	12
31481	80 mm	12
31491	100 mm	12
31467	120 mm	12
31468	140 mm	12

**FESTA**

ШПАКЛА, НЕРЪЖДАЕМА СТОМАНА

INOX

№	Характеристики	
31498	150 mm	12
31499	200 mm	12
31500	100 mm	12



ШПАКЛА, НЕРЪЖДАЕМА СТОМАНА

INOX

MADE IN EU

№	Характеристики	
31493	40 mm	20
31494	60 mm	20
31495	80 mm	20
31496	100 mm	20



ШПАКЛА

R.s.	leirás	
32176	30 mm	12
32186	40 mm	12
32196	50 mm	12
32206	60 mm	12
32216	80 mm	12
32226	100 mm	12
32234	125 mm	12



КОМПЛЕКТ ШПАКЛИ

3x

№	Характеристики	
32240	30, 50, 80 mm	10

**FESTA**

ШПАКЛА

№	Характеристики		№	Характеристики	
32161	30 mm	10	32171	90 mm	10
32162	40 mm	10	32166	100 mm	10
32163	50 mm	10	32172	110 mm	10
32164	60 mm	10	32167	120 mm	10
32169	70 mm	10	32168	140 mm	10
32165	80 mm	10			



ВАЛЯК ЗА НАНАСЯНЕ НА МАЛАМАШКАТА

- Дръжка 180 mm - 52630
- Дръжка 250 mm - 52625
- Дръжка 52010, 52011, 52012, 52020, 52030



№	Характеристики				
52611	250 mm	∅ 8 mm	∅ 48 mm	50	
52612	180 mm	∅ 8 mm	∅ 48 mm	10	

FESTA

ШПАТУЛИ
ЗА ЗАПЕЧАТВАНЕ
НА ЦЯЛАТА ПЛОЩ

INOX

R.s.	leirás	
31555	35 cm	1
31556	45 cm	1
31557	60 cm	1
31558	80 cm	1
31559	100 cm	1



FESTA

ТЕЛЕСКОПИЧНА ДРЪЖКА

· резба за 31610, 34203

№	Характеристики	
52011	88- 140 cm	1



FESTA

ДЪРЖАЧ ЗА ШПАТУЛА
ЗА УПЛЪТНЯВАНЕ НА
ЦЯЛАТА ПОВЪРХНОСТ

· за 31555- 31559
· дръжка 52010, 52011, 52012, 52020, 52030

№	Характеристики	
31610		1



ШПАТУЛА
ОТ НЕРЪЖДАЕМА
СТОМАНА

INOX

MADE IN EU

№	Характеристики	
31520	400 mm	1
31521	500 mm	
31522	600 mm	



дръжка 61254



АКСЕСОАРИ ЗА ШПАТУЛА ОТ НЕРЪЖДАЕМА
СТОМАНА

MADE IN EU

№	Характеристики	
31523	ALU holder	1
31524	plastic holder	1

ФАСАДНА ШПАКЛА,
НЕРЪЖДАЕМА
СТОМАНА

INOX

№	Характеристики	
31552	400 mm	10
31553	600 mm	10



ФАСАДНА ШПАКЛА,
НЕРЪЖДАЕМА
СТОМАНА

INOX

MADE IN EU

№	Характеристики	
31541	250 mm	1
31551	250 mm Скосена	1



СТОМАНЕНА МАЛАМАШКА

№	Характеристики	
32062	280 x 160 mm	10
32060	500 x 140 mm	5

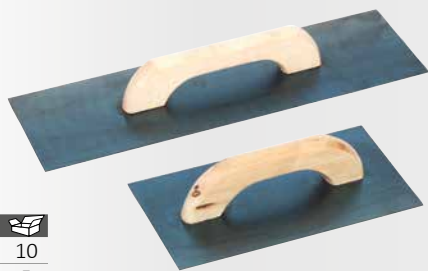

СТОМАНЕНА МАЛАМАШКА

№	Характеристики	
32064	500 x 90 mm	5
32066	550 x 140 mm	5



ТРАПЕЦОВИДНА МИСТРИЯ

№	Характеристики	
32015	160 x 130 mm	10
32014	180 x 130 mm	10
32016	200 x 140 mm	10



ТРАПЕЦОВИДНА МИСТРИЯ

№	Характеристики	
32001	160 x 110 mm	10
32002	160 x 130 mm	10
32003	180 x 130 mm	10
32013	200 x 140 mm	10



МИСТРИЯ СЪС ЗАОБЛЕН ВРЪХ

№	Характеристики	
32018	160 x 110 mm	10



ПРАВА МИСТРИЯ

№	Характеристики	
32024	140 x 80 mm	12



МИСТРИЯ СЪС ЗАОБЛЕН ВРЪХ

№	Характеристики	
32020	140 x 65 mm	12
32021	140 x 40 mm	12



ТРИЪГЪЛНА МИСТРИЯ

№	Характеристики	
32026	140 x 85 mm	12



FESTA

КАНЧОК ОТ НЕРЪЖДАЕМА СТОМАНА

INOX		
№	Характеристики	
32285	∅ 180 mm	1



FESTA

ПОЦИНКОВАН КАНЧОК

Zn		
№	Характеристики	
32265	∅ 180 mm	10



FESTA

КАНЧОК

№	Характеристики	
32273	∅ 160 mm	10
32283	∅ 180 mm	10
32293	∅ 215 mm	10



ПЛАСТМАСОВ КАНЧОК

		
№	Характеристики	
32270	∅ 160 mm	1



КАНЧОК

· Препоръчва се с дръжка 61215

№	Характеристики	
32302	Ø 180 mm	1
32313	Ø 215 mm	1
32301	Ø 235 mm	1



КАНЧОК БЕЗ ДРЪЖКА

· Препоръчва се с дръжка 61200, 61201

№	Характеристики	
32268	Ø 215 mm	1
32269	Ø 235 mm	1
32296	Ø 215 mm	1



ГРЕБЛО ЗА БЕТОН

№	Характеристики	
60100	Гребло за бетон 295 x 150 mm	24
61169	Гребло за бетон с дръжка 160 cm	3
61218	Дръжка 160 cm	5



КАНЧОК С ДРЪЖКА

MOQ 3

№	Характеристики	
32295	Ø 180 mm Дължина на дръжката 160 cm	3
32297	Ø 215 mm Дължина на дръжката 160 cm	3
32298	Ø 235 mm Дължина на дръжката 160 cm	3



ШТРОБОРЕЗ
ДЛЯ УТОНГ

№	Характеристики	
32037	600 mm	1



КУТНИК ДЛЯ
ГАЗОБЛОКІВ УТОНГ

№	Характеристики	
32038	270 x 270 x 270 mm	1



КЕЛЪМА
УТОНГ

№	Характеристики	
32089	150 mm	1



FESTA

ДЛЕТО, ПЛОСКО (СЕКАЧ)

CrV	№	Характеристики	Широчина hrotu	
	19406	300 mm	25 mm	5
19407	400 mm	30 mm	5	



FESTA

ДЛЕТО, ОСТРО

CrV	№	Характеристики	
	19408	250 mm	5
19409	350 mm	5	



FESTA

ДЛЕТО, ПЛОСКО (СЕКАЧ)

CrV	№	Характеристики	Широчина hrotu	
	19460	300 mm	25 mm	5
19470	400 mm	30 mm	5	



ДЛЕТО, ОСТРО

№	Характеристики	
19400	250 mm	5
19403	350 mm	6



ДЛЕТО, ПЛОСКО (СЕКАЧ)

№	Характеристики	Широчина hrotu	
19401	250 mm	19 mm	6
19404	350 mm	22 mm	6



ДЛЕТО, ПЛОСКО (СЕКАЧ)

№	Характеристики	Широчина hrotu	
19402	250 mm	50 mm	2
19405	350 mm	50 mm	6





NEW

FESTA

МНОГОФУНКЦИОНАЛНА
ШПАКЛА

INOX

№	Характеристики
31519	75 mm



10

МНОГОФУНКЦИОНАЛНА
ШПАКЛА

INOX

№	Характеристики
31497	63 x 195 mm

12



FESTA

НОЖ
ЗА ШПАКЛОВАНЕ

INOX

№	Характеристики
31503	150 mm

12



БОЯДЖИЙСКА СКРАБКА

MADE IN
EU

№	Характеристики
31501	100 mm
31502	Резервно острие

30

1

ШПАКЛА
ЗА ГИПСОКАРТОН

PLASTIC

№	Характеристики
34308	50 mm
34307	80 mm
34306	100 mm
34305	150 mm

20

12

10

12



ШКУРКОДЪРЖАЧ

№	Характеристики
34301	230 x 105 mm
34304	235 x 80 mm

1

1



FESTA

ШКУРКОДЪРЖАЧ

№	Характеристики
34200	210 x 115 mm
34201	240 x 105 mm
34202	240 x 80 mm

30

50

50



РЕЗЕРВНА ФИНА ГЪБА

Дръжка 52030

ALU

№	Характеристики
34203	230 x 80 mm Алуминиев
52030	Телескопична дръжка

1

12

КОМПЛЕКТ
СИЛИЦИЕВА
ШКУРКА

10x

№	Характеристики
34271	115 x 290 mm zrn. 120
34272	115 x 290 mm zrn. 100
34273	115 x 290 mm zrn. 80
34274	93 x 290 mm zrn. 120
34275	93 x 290 mm zrn. 100
34276	93 x 290 mm zrn. 80

80

80

80

80

80

80

80

КОМПЛЕКТ
СИЛИЦИЕВА
ШКУРКА

3x

№	Характеристики
34280	115 x 290 mm zrn. 120
34281	115 x 290 mm zrn. 100
34282	115 x 290 mm zrn. 80
34283	93 x 290 mm zrn. 120
34284	93 x 290 mm zrn. 100
34285	93 x 290 mm zrn. 80

20

20

20

20

20

20

20

FESTA

КОМПЛЕКТ ШПАКЛИ

4x

№	Характеристики	Кол-во
31452	Неръждаема стомана 50, 80, 100, 120 mm	10
31453	Метал 50, 80, 100, 120 mm	10

FESTA

КОМПЛЕКТ ШПАКЛИ

4x

№	Характеристики	Кол-во
31454	50, 80, 100, 120 mm	12

НАЗЪБЕНА ШПАКЛА

№	Характеристики	Кол-во
31601	180 mm - Права	1
31602	180mm A1	1
31603	180mm A2	1
31641	180 mm - e4	1

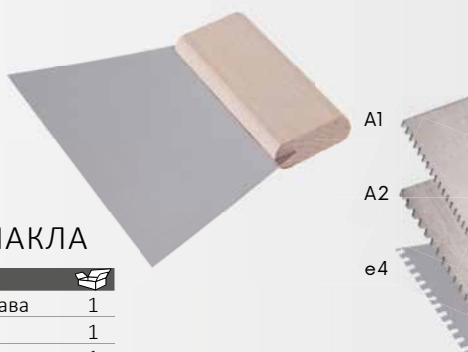

НАЗЪБЕНА ШПАКЛА, INOX

№	Характеристики	Кол-во
31651	250 mm - Права	1
31655	250 mm - e4	1

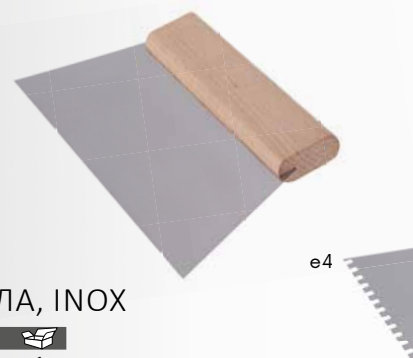

ШПАТУЛА
ЗА ФУГИРАНЕ,
НАЗЪБЕНА

№	Характеристики	Кол-во
37101	125 x 85 mm	100
37111	170 x 115 mm	100



ШПАТУЛА
ЗА ФУГИРАНЕ

№	Характеристики	Кол-во
37051	Права	1
37031	zub- 4 x 6 mm	1
37041	zub- 6 x 6 mm	1



МИСТРИЯ
ЗА ФУГИРАНЕ

№	Характеристики	Кол-во
32022	140 x 80 mm	12
32023	125 x 40 mm	12



МИСТРИЯ ЗА ФУГИРАНЕ,
ЕДНОСТРАННА

№	Характеристики	Кол-во
32040	10 mm	20
32041	12 mm	20
32042	15 mm	20
32043	18 mm	20
32044	20 mm	20



МИСТРИЯ ЗА ФУГИРАНЕ,
ДВУСТРАННА

№	Характеристики	Кол-во
32050	10 12 mm	50
32051	10 15 mm	50
32052	10 18 mm	50
32053	15 20 mm	50

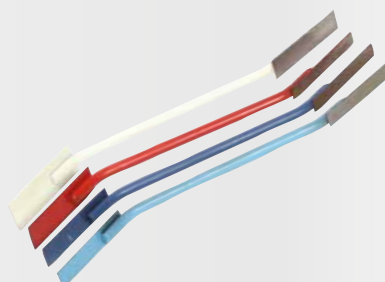

FESTAСКРАБКА ЗА
ГАЗОБЕТОН ИТОНГ,
ДЪРВЕНА

· Топола



№ 32317 Характеристики 450 x 95 mm

2

FESTAУТОНГ
СКРЕПЕР
ФИН ЗЪБ

· Топола



№ 32312 Характеристики 450 x 95 mm

2

FESTAСКРАБКА ЗА
ГАЗОБЕТОН
ИТОНГ, ДЪРВЕНА

· Топола



№ 32337 Характеристики 260 x 95 mm

2

FESTAУТОНГ СКРЕПЕР
ФИН ЗЪБ

· Топола



№ 32338 Характеристики 260 x 95 mm

2

**FESTA**СКРАБКА ЗА
ГАЗОБЕТОН ИТОНГ,
ДЪРВЕНА

· Топола



№ 32327 Характеристики 230 x 145 mm

2

СКРАБКА ЗА
ГАЗОБЕТОН ИТОНГ,
ДЪРВЕНА

№ 32332 Характеристики 450 x 95 mm

2

СКРАБКА ЗА
ГАЗОБЕТОН ИТОНГ,
ДЪРВЕНА

№ 32333 Характеристики 230 x 145 mm

2

FESTAРЕНДЕ
ЗА МАЗИЛКА

№ 32314 Характеристики 400 x 180 mm

2

FESTAРЕНДЕ
ЗА МАЗИЛКА

№ 32329 Характеристики 270 x 130 mm

2

РЕНДЕ
ЗА МАЗИЛКА

№ 33168 Характеристики 380 x 160 mm

2

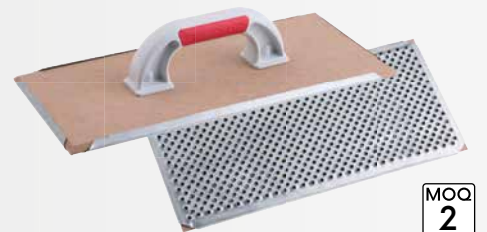
FESTAРЕНДЕ
ЗА МАЗИЛКА

№ 32320 Характеристики 400 x 180 mm

2

РЕНДЕ
ЗА МАЗИЛКА



MOQ 2

№	Характеристики	
32311	400 x 180 mm	2

FESTA

МАЛАМАШКА
С АБРАЗИВ ЗА
ПОЛИСТИРЕН,
ПЛАСТМАСОВА



MOQ 2

№	Характеристики	
32324	270 x 130 mm P 16	2
32323	270 x 130 mm P 16 Шкурка	10

FESTA

МАЛАМАШКА
С АБРАЗИВ ЗА
ПОЛИСТИРЕН,
ДЪРВЕНА



MOQ 2

№	Характеристики	
32318	400 x 180 mm	2
32319	500 x 250 mm	2
32321	400 x 180 mm P 16 Шкурка	10
32322	500 x 250 mm P 16 Шкурка	10

FESTA

МАЛАМАШКА
С АБРАЗИВ ЗА
ПОЛИСТИРЕН,
ПЛАСТМАСОВА



MOQ 2

№	Характеристики	
32330	400 x 180 mm	2
32331	270 x 130 mm	2

СТЪРГАЛО ЗА
КАМЕННА ВАТА

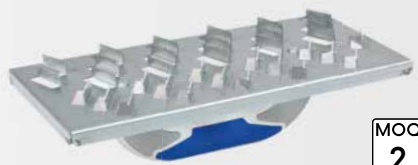

MOQ 2

№	Характеристики	
32328	285 x 145 mm	10

FESTA

РЕНДЕ
ЗА МАЗИЛКА



MOQ 2

№	Характеристики	
32325	225 x 105 mm	2

РЕНДЕ
ЗА МАЗИЛКИ,
РЕШЕТКА

№	Характеристики	
32316	280 x 150 mm	20

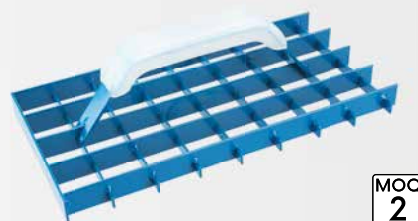

MOQ 2

РЕНДЕ
ЗА МАЗИЛКИ
СЪС ЗЪБИ

№	Характеристики	
32335	290 x 145 mm	2

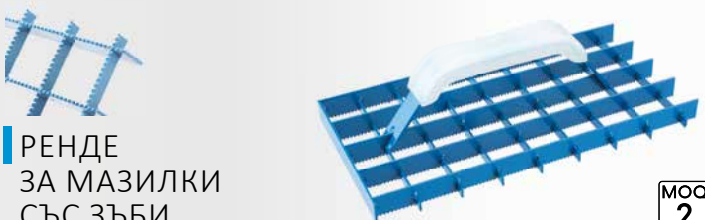

MOQ 2

РЕНДЕ
ЗА ГАЗОБЕТОН

· 8 ръба



№	Характеристики	
32326	450 x 90 mm	20



MOQ 2

РЕНДЕ
ЗА ПОЛИСТИРЕН

· 6 ръба

№	Характеристики	
32315	270 x 90 mm	30



MOQ 2

FESTA

ПЛАСТМАСОВА
МАЛАМАШКА,
ГЛАДКА



MOQ 2

№	Характеристики	
34027	400 x 180 mm	20

ПЛАСТМАСОВА
МАЛАМАШКА,
ГЛАДКА



MOQ 2

№	Характеристики	
34028	400 x 180 mm	20

FESTAМАЛАМАШКА,
ПЛАСТМАСА
ABSMADE IN
EU

№	Характеристики	
34041	280 x 140- 2 mm	10
34051	280 x 140- 3 mm	10
34053	280 x 140- 3 mm Зъби- еб	10

FESTAПЛАСТМАСОВА
МАЛАМАШКА

С.р.	спецификация	
30003	270 x 125 mm	28
30004	235 x 115 mm	35
30005	210 x 115 mm	38
30007	210 x 60 mm	44

FESTAДЪРВЕНА
МАЛАМАШКА

Дървесина: липа



№	Характеристики	
34005	400 x 145 mm	40
34007	290 x 145 mm	20

ДЪРВЕНА
МАЛАМАШКА

Тополово дърво

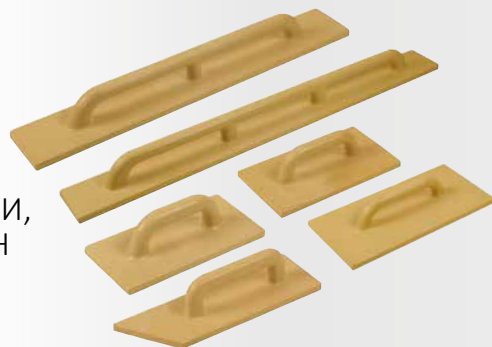

№	Характеристики	
34006	400 x 145 mm	40

МАЛАМАШКИ,
ПОЛИУРЕТАНMADE IN
EU

№	Характеристики		№	Характеристики	
34122	120 x 240 mm	50	34154	220 x 420 mm	15
34132	140 x 280 mm	40	34155	240 x 480 mm	15
34142	180 x 320 mm	25	34156	280 x 500 mm	10
34152	200 x 360 mm	20	34157	330 x 330 mm	5
34121	80 x 260 mm Скосена	50	34158	120 x 800 mm	5
34153	100 x 400 mm	30	34159	120 x 1000 mm	5
			34160	120 x 1200 mm	5

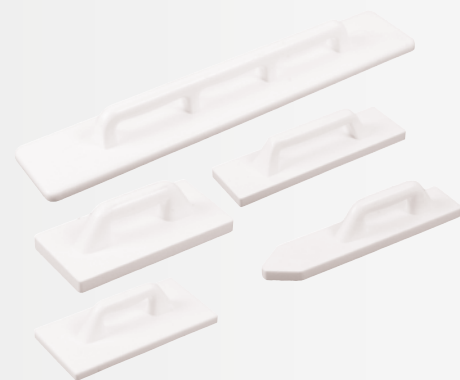
МАЛАМАШКИ,
ПОЛИСТИРЕНMADE IN
EU

№	Характеристики	
34101	80 x 350 mm Скосена	10
34061	130 x 270 mm	10
34111	170 x 320 mm	10
34071	130 x 450 mm	10
34081	140 x 750 mm	10
34091	140 x 900 mm	5

МАЛАМАШКИ,
ПОЛИУРЕТАН

№	Характеристики	
34115	140 x 280 mm	36
34116	180 x 320 mm	36
34117	200 x 360 mm	24

МАСТАР ЗА
ЗАГЛАЖДАНЕ
НА БЕТОНMADE IN
EU

№	Характеристики	
15889	980 x 380 mm Дръжка Ø 32 mm	1

ШПАКЛА С ГУМА

№	Характеристики	
15886	450 mm Дръжка Ø 23 mm	48
15887	600 mm Дръжка Ø 23 mm	48
15888	750 mm Дръжка Ø 23 mm	32

РАЗСТИЛАЩО
ГРЕБЛОMADE IN
EU

№	Характеристики	
15885	100 x 800 mm Дръжка Ø 32 mm	1

МАТЕРИАЛ ПОВЪРХНОСТ			ГИПС			ЛЕПИЛА И УПЛЪТНИТЕЛИ	ФАСАДНО ЛЕПИЛО	ПРИЛОЖЕНИЕ
	ГРУБА	ЗАМАЗКА	БЕТОНОВО ЯДРО	ВЪТРЕШНИ ЗАМАЗКИ	ГАЗОБЕТОН			
ЧЕРЕН ФИЛЦ (КАФЯВ, СИВ)				••••		••		За изравняване на мазилка с по-голяма зърненост
БЯЛ ФИЛЦ				••••	••••	••••		За изравняване на мазилка с по-малка зърненост
ФИНА ГЪБА				••••	••••	••••		За отстраняване на фини частици и измиване след фугиране
ГРУБА ГЪБА				••••	••••	••••		За отстраняване на фини частици от груба мазилка
ДУНАПРЕН С РАСТЕРИЗАЦИЯ				••••	••••	••••		За отстраняване на големи частици благодарение на растеризацията
МОРСКА ГЪБА						•••	••••	За отмиване на строителен разтвор, за фини частици
ХИДРОГЪБА, ГРУБА						•	••••	За отмиване на строителен разтвор, за големи частици
ГЪБА				••	••••	••	••••	За отмиване на строителен разтвор и почистване на фина мазилка
ПОРЕСТА ГЪБА							••••	За заглаждане на мазилката и довършителни работи
КАУЧУКОВА ПЯНА							••••	За заглаждане на мазилката и довършителни работи
MIRELON		••••	•••					За обработка на бетон и покриване на ядрото
DUREN				••••	••	••••		За заглаждане на мазилка и довършителни работи
ДЪРВО	••••	••••	••••					За обработка на бетон и покриване на ядрото
СТОМАНЕНА ПЛОЧА	••	••••		••		••••	••	За заглаждане на бетон, за труднодостъпни участъци
ПОЛИСТИРЕН	•••	••••	•••	••		••		За обработка на бетон и покриване на ядрото
ПОЛИУРЕТАН	••••	••••	••••					За обработка на бетон и покриване на ядрото
ABS		••		••••	••••	••••	••••	За разнасяне и разстилане на мазилки, лепила и уплътнители
НЕРЪЖДАЕМА СТОМАНА, ГЛАДКА				••••	••••	••••	••••	За разнасяне на мазилки и фасадни лепила
НЕРЪЖДАЕМА СТОМАНА, НАЗЪБЕНА							••••	За разнасяне на лепило и уплътнители върху настилки и фасади
ЗА ШЛИФОВАНЕ НА ПОЛИСТИРЕН, ПЛАСТМАСОВА			••				••••	За шлифване на полистирен, цимент, бетон и фасадни лепила
ЗА ШЛИФОВАНЕ НА ПОЛИСТИРЕН			••				••••	За шлифване на полистирен и фасадни лепила

**FESTA**МАЛАМАШКА
С БЯЛ ФИЛЦ

№	Характеристики	Кол-во
34400	280 x 140 x 8 mm	15
34415	250 x 130 x 8 mm	15
34450	220 x 130 x 8 mm	15
34445	220 x 70 x 8 mm	20

**FESTA**МАЛАМАШКА
С ЧЕРЕН ФИЛЦ

№	Характеристики	Кол-во
34401	280 x 140 x 10 mm	15
34416	250 x 130 x 10 mm	15
34451	220 x 130 x 10 mm	15
34446	220 x 70 x 10 mm	20

**FESTA**МАЛАМАШКА
С ФИН
ДУНАПРЕН

№	Характеристики	Кол-во
34404	280 x 140 x 30 mm	10
34485	280 x 130 x 20 mm	10
34486	250 x 130 x 20 mm	10
34419	250 x 130 x 20 mm	10
34453	220 x 130 x 20 mm	10
34447	220 x 70 x 20 mm	10

**FESTA**МАЛАМАШКА
С ФИНА ГЪБА

№	Характеристики	Кол-во
34405	280 x 140 x 18 mm	15
34420	250 x 130 x 18 mm	15
34454	220 x 130 x 18 mm	15
34449	220 x 70 x 18 mm	20
34480	280 x 140 x 12 mm	15
34481	250 x 130 x 12 mm	15
34482	220 x 130 x 12 mm	15

**FESTA**МАЛАМАШКА
СЪС СУПЕРФИНА
ГЪБА

№	Характеристики	Кол-во
34443	280 x 140 x 12 mm	15
34442	250 x 130 x 12 mm	15

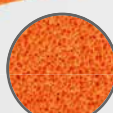
**FESTA**МАЛАМАШКА
С ГРУБА ГЪБА

№	Характеристики	Кол-во
34441	280 x 140 x 12 mm	15
34440	250 x 130 x 12 mm	15
34439	250 x 130 x 18 mm	15



FESTA

МАЛАМАШКА
С ФИН ДУНАПРЕН
С РАСТЕРИЗАЦИЯ



№	Характеристики	
34409	280 x 140 x 30 mm	10
34425	250 x 130 x 20 mm	10

FESTA

МАЛАМАШКА
С ГРУБ
ДУНАПРЕН



№	Характеристики	
34410	280 x 140 x 30 mm	10
34426	250 x 130 x 20 mm	10

FESTA

МАЛАМАШКА
С МОРСКА ГЪБА



№	Характеристики	
34406	280 x 140 x 30 mm	10
34421	250 x 130 x 30 mm	10
34455	220 x 130 x 30 mm	10

FESTA

МАЛАМАШКА
С МОРСКА ГЪБА,
С РАСТЕРИЗАЦИЯ



№	Характеристики	
34413	280 x 140 x 30 mm	10
34428	250 x 130 x 30 mm	10

FESTA

МАЛАМАШКА
С ХИДРОГЪБА



№	Характеристики	
34412	280 x 140 x 30 mm	10
34424	250 x 130 x 30 mm	10
34458	220 x 130 x 30 mm	10

FESTA

МАЛАМАШКА
С ХИДРОГЪБА
С РАСТЕРИЗАЦИЯ



№	Характеристики	
34490	280 x 140 x 30 mm	10
34491	250 x 130 x 30 mm	10

FESTA

МАЛАМАШКА
С ФИНА
ХИДРОГЪБА



№	Характеристики	
34411	280 x 140 x 30 mm	10
34423	250 x 130 x 30 mm	10
34457	220 x 130 x 30 mm	10

FESTA

МАЛАМАШКА
С ГУМИРАНА ГЪБА



№	Характеристики	
34402	280 x 140 x 10 mm	15
34417	250 x 130 x 10 mm	15
34452	220 x 130 x 10 mm	15

FESTA

МАЛАМАШКА
С ПОРЕСТА ГЪБА,
С МИКРОПОРИ



№	Характеристики	
34403	280 x 140 x 8 mm	15
34418	250 x 130 x 8 mm	15
34496	220 x 130 x 8 mm	15

FESTA

МАЛАМАШКА
С DUREN



№	Характеристики	
34407	280 x 140 x 20 mm	10
34422	250 x 130 x 20 mm	10
34456	220 x 130 x 20 mm	10
34448	220 x 70 x 20 mm	10

FESTA

МАЛАМАШКА
(RUVEN)



№	Характеристики	
34414	280 x 140 x 20 mm	10
34429	250 x 130 x 20 mm	10

FESTA

ПЛАСТМАСОВА
МАЛАМАШКА



№	Характеристики	
30003	270 x 125 mm	28
30004	235 x 115 mm	35
30005	210 x 115 mm	38
30007	210 x 60 mm	44

FESTAМАЛАМАШКА
ЗА ФУГИMADE IN
EU

№	Характеристики	Икона
34033	240 x 95 mm	5

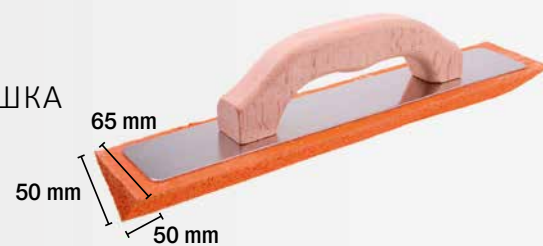
ЪГЛОВА
МАЛАМАШКА
С ГЪБА,
90°

№	Характеристики	Икона
34500	350 mm	6

РЕЗЕРВЕН
БЯЛ ФИЛЦMADE IN
EU

№	Характеристики	Икона
34241	280 x 140 x 8 mm	1
34223	250 x 130 x 8 mm	1

РЕЗЕРВЕН
ЧЕРЕН ФИЛЦMADE IN
EU

№	Характеристики	Икона
34243	280 x 140 x 10 mm	1
34221	250 x 130 x 10 mm	1

РЕЗЕРВНА
ФИНА ГЪБАMADE IN
EU

№	Характеристики	Икона
34262	280 x 140 x 18 mm	1

РЕЗЕРВЕН
ФИН ДУНАПРЕНMADE IN
EU

№	Характеристики	Икона
34251	280 x 140 x 30 mm	1

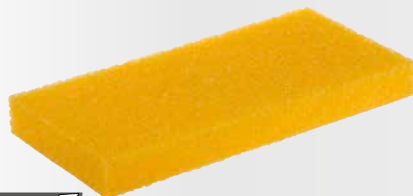
РЕЗЕРВЕН
ГРУБ
ДУНАПРЕНMADE IN
EU

№	Характеристики	Икона
34261	280 x 140 x 30 mm	1

РЕЗЕРВНА
МОРСКА
ГЪБАMADE IN
EU

№	Характеристики	Икона
34265	280 x 140 x 30 mm	1

РЕЗЕРВНА
ХИДРОГ
ЪБАMADE IN
EU

№	Характеристики	Икона
34238	280 x 140 x 30 mm	1

РЕЗЕРВНА
ФИНА
ХИДРОГЪБАMADE IN
EU

№	Характеристики	Икона
34237	280 x 140 x 30 mm	1
34235	250 x 130 x 30 mm	1

РЕЗЕРВНА
ГУМИРАНА
ГЪБАMADE IN
EU

№	Характеристики	Икона
34231	280 x 140 x 10 mm	1



FESTA

ЕЛЕКТРИЧЕСКА БЪРКАЛКА ЗА СТРОИТЕЛНИ СМЕСИ, 850 W

Входяща мощност	1800 W
Напрежение	230 V / 50 Hz
Брой скорости	2
1-ва скорост (обороты на празен ход)	0- 450 об. / мин.
2-ва скорост (обороты на празен ход)	0- 790 об. / мин.
Защита	Да
Диаметър на бъркалката	100 mm
Дължина на бъркалката	570 mm
Тегло	5,6 kg



№	Характеристики	Кол-во
35311		1
35318	Резервен накрайник	1
35319	spare stirrers- pair (L + R)	1



FESTA

ЕЛЕКТРИЧЕСКА БЪРКАЛКА ЗА СТРОИТЕЛНИ СМЕСИ, 1600 W

Входяща мощност	1600 W
Напрежение	230 V / 50 Hz
Брой скорости	2
1-ва скорост (обороты на празен ход)	0 - 480 об. / мин.
2-ва скорост (обороты на празен ход)	0 - 800 об. / мин.
Защита	Да
Резба	M 14
Диаметър на бъркалката	140 mm
Дължина на бъркалката	600 mm
Тегло	4,7 kg

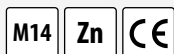

№	Характеристики	Кол-во
35310		1
35317	Резервен накрайник	1



FESTA

ЕЛЕКТРИЧЕСКА БЪРКАЛКА ЗА СТРОИТЕЛНИ СМЕСИ, 850 W

Входяща мощност	850 W
Напрежение	230 V / 50 Hz
Брой скорости	1
1-ва скорост (обороты на празен ход)	0 - 500 об. / мин.
2-ва скорост (обороты на празен ход)	-
Защита	Да
Резба	M 14
Диаметър на бъркалката	120 mm
Дължина на бъркалката	600 mm
Тегло	3,7 kg

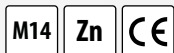

№	Характеристики	Кол-во
35300		1
35316	Резервен накрайник	1



**WEST
BERG****ЕЛЕКТРИЧЕСКА БЪРКАЛКА ЗА СТРОИТЕЛНИ СМЕСИ, 1600 W**

Входяща мощност	1600 W
Напрежение	230 V / 50 Hz
Брой скорости	2
1-ва скорост (обороти на празен ход)	180- 400 ot./min.
2-ва скорост (обороти на празен ход)	300- 700 ot./min.
Защита	Да
Резба	M 14
Диаметър на бъркалката	140 mm
Дължина на бъркалката	600 mm
Тегло	5,4 kg

M14 Zn CE

№	Характеристики	
35305		1
35315	Резервен накрайник	1

**NEW****FESTA****УДЪЛЖИТЕЛ
ЗА БЪРКАЛКУ
ЗА СМЕСИ****M14**

№	Характеристики	
35142	M14	1



20 cm

**NEW****FESTA****БЪРКАЛКА ЗА СМЕСИ С ДЯСНА НАВИВКА**

Спирална бъркалка с дясна навивка, 3 остриета и пръстен за тежки строителни разтвори с висок вискозитет, бетон, цимент и варови мазилки, уплътняващи материали, епоксидни смоли, битумни слоеве и други. Смесване от долу нагоре (като винт).

№	Характеристики	
Zn M14 35085	M14 Ø 120 x 600 mm	12
35086	M14 Ø 140 x 600 mm	12
35087	M14 Ø 160 x 600 mm	12

**FESTA****БЪРКАЛКА ЗА СМЕСИ, С ЛЯВА НАВИВКА**

Спирална бъркалка с лява навивка, 3 остриета и пръстен за редки разтвори в големи количества, като например бои. Смесеният материал се избутва надолу. Разтворът не се разлива от контейнера и боите се смесват идеално.

№	Характеристики	
Zn M14 35091	M14 Ø 120 x 600 mm	12
35092	M14 Ø 140 x 600 mm	12
35093	M14 Ø 160 x 600 mm	12

**FESTA****БЪРКАЛКА ЗА СМЕСИ, С ПРЪСТЕН**

Спирална бъркалка с две остриета за отлично миксиране на смеси за лепене на плочки, уплътняващи и свързващи материали, лепила, мазилки и замазки.

№	Характеристики	
Zn 35038	Ø 80 x 500 mm	24
35058	Ø 100 x 500 mm	24
35023	Ø 120 x 500 mm	24



FESTA**БЪРКАЛКА ЗА СМЕСИ, SDS+**

Спирална бъркалка SDS+ с две остриета за отлично миксиране на смеси за лепене на плочки, уплътняващи и свързващи материали, лепила, мазилки и замазки.

SDS+	Zn	№	Характеристики	
		35094	Ø 80 x 500 mm	24
		35095	Ø 100 x 500 mm	24
		35096	Ø 120 x 500 mm	24



**FESTA****БЪРКАЛКА ЗА СМЕСИ, SDS+**

Спирална бъркалка SDS+ с две остриета за отлично миксиране на смеси за лепене на плочки, уплътняващи и свързващи материали, лепила, мазилки и замазки.

M14	Zn	№	Характеристики	
		35059	M14 Ø 90 x 550 mm	24



**FESTA****УДЪЛЖЕНА БЪРКАЛКА ЗА СМЕСИ**

Удължена спирална бъркалка с две остриета за отлично миксиране на смеси за лепене на плочки, уплътняващи и свързващи материали, лепила, мазилки и замазки.

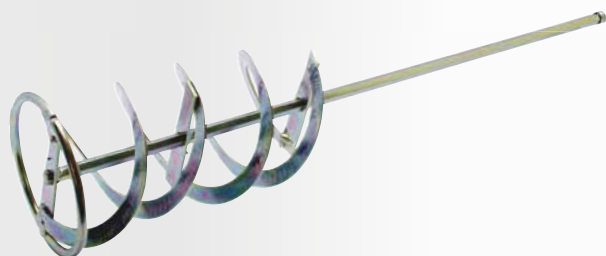
	Zn	№	Характеристики	
		35013	Ø 80 x 500 mm	24
		35006	Ø 100 x 500 mm	24
		35007	Ø 120 x 500 mm	24



**FESTA****УДЪЛЖЕНА БЪРКАЛКА ЗА СМЕСИ**

Удължена спирална бъркалка с две остриета за отлично миксиране на смеси за лепене на плочки, уплътняващи и свързващи материали, лепила, мазилки и замазки.

SDS+	Zn	№	Характеристики		
		35012	Ø 100 x 500 mm	24	

**FESTA****БЪРКАЛКА ЗА СМЕСИ**

Спирална бъркалка с две остриета за отлично миксиране на смеси за лепене на плочки, уплътняващи и свързващи материали, лепила, мазилки и замазки.

	Zn	№	Характеристики	
		35069	Ø 60 x 500 mm	50
		35078	Ø 80 x 500 mm	24
		35081	Ø 100 x 500 mm	24

**FESTA****БЪРКАЛКА ЗА СМЕСИ, SDS+**

Спирална бъркалка с две остриета за отлично миксиране на смеси за лепене на плочки, уплътняващи и свързващи материали, лепила, мазилки и замазки.

SDS+	Zn	№	Характеристики	
		35070	Ø 60 x 500 mm	50
		35079	Ø 80 x 500 mm	24
		35082	Ø 100 x 500 mm	24



FESTA**БЪРКАЛКА ЗА СМЕСИ, БЕЗ ПРЪСТЕН**

Спирална бъркалка с две остриета за отлично миксиране на смеси за лепене на плочки, уплътняващи и свързващи материали, лепила, мазилки и замазки.

№	Характеристики	
35048	Ø 70 x 500 mm	24
35068	Ø 90 x 500 mm	24

**FESTA****БЪРКАЛКА ЗА СМЕСИ, БЕЗ ПРЪСТЕН**

Спирална бъркалка за разтвори с висок вискозитет и лепливи материали като строителни лепила и уплътнители, цимент, мазики, замазки и други. Смесването е от долу нагоре.

№	Характеристики	
35021	Ø 90 x 500 mm	24

**FESTA****МИКСЕР СЪС СПИРАЛОВИДЕН РЪБ**

Бъркалка за смеси тип KR за разтвори с повишена възможност за образуване на буци, течни разтвори, замазки, уплътняващи материали и лепила.

№	Характеристики	
35015	Ø 100 x 500 mm	20

**FESTA****ДИСКОВА БЪРКАЛКА ЗА СМЕСИ, ПОЦИНКОВАНА**

Дискова поцинкована бъркалка за смеси за лесно течливи разтвори, бои, разтвори за стени и лепила, подови замазки и др.

№	Характеристики	
35011	Ø 80 x 500 mm	50

**БЪРКАЛКА ЗА СМЕСИ, ПОЦИНКОВАНА**

Поцинкована бъркалка за смеси с пръстен тип FM за отлично разбъркване на течни материали като бои, лакове, грундове, лепила, декоративни мазилки, уплътняващи материали, покрития и други.

№	Характеристики	
35125	Ø 60 x 400 mm	40
35126	Ø 80 x 400 mm	40
35127	Ø 100 x 600 mm	20

**БЪРКАЛКА ЗА СМЕСИ, ЛАКИРАНА**

Бъркалка за смеси с пръстен тип FM за отлично разбъркване на течни материали като бои, лакове, грундове, лепила, декоративни мазилки, уплътняващи материали, покрития и други.

№	Характеристики	
35103	Ø 60 x 400 mm	40
35113	Ø 80 x 400 mm	40
35123	Ø 100 x 600 mm	20



FESTA



ПРОФЕСИОНАЛНИ МИКСЕРИ ЗА БЕТОН

Lescha

Бетон миксери за професионална употреба
Чугунен венец с патентовано закрепване
Регулируеми зъби
Висококачествено покритие
Двойни лагери на барабана
Патентована защитна изолация
в съответствие с DIN EN ISO 9001
Специално проектирана форма на барабана
Защита срещу разпръскване IP 45
Възможност за захранване 230 V и 400 V



Lescha

МИКСЕР ЗА БЕТОН



№	Характеристики	
35500	Star 150- 125 l, 230 V Спирачка на колелата	1



Lescha

МИКСЕР ЗА БЕТОН



№	Характеристики	
35502	EUROMIX 125 l, 230 V	1
35503	EUROMIX 125 l, 400 V	1



Lescha

МИКСЕР ЗА БЕТОН



№	Характеристики	
35501	BX 135- 125 l, 230 V	1



Lescha

МИКСЕР ЗА БЕТОН



№	Характеристики	
35504	ABM 135 l, 230 V Спирачка на колелата	1



Lescha

МИКСЕР ЗА БЕТОН



№	Характеристики	
35505	SM 145 S- 140 l, 230 V	1
35506	SM 145 S- 140 l, 400 V	1
35507	SM 145 S- 140 l, 230 V Спирачка на колелата	1
35508	SM 145 S- 140 l, 400 V Спирачка на колелата	1



Lescha

МИКСЕР ЗА БЕТОН



№	Характеристики	
35510	SM 165 S- 160 l, 230 V Спирачка на колелата	1
35511	SM 165 S- 160 l, 400 V Спирачка на колелата	1
35512	SM 165 S- 160 l, G бензин	1



Lescha

МИКСЕР ЗА БЕТОН



№	Характеристики	
35514	SM 185 S- 180 l, 230 V Спирачка на колелата	1
35515	SM 185 S- 180 l, 400 V Спирачка на колелата	1



Lescha

МИКСЕР ЗА БЕТОН



№	Характеристики	
35516	S 180 HR- 180 l, 230 V Спирачка на колелата	1
35517	S 180 HR- 180 l, 400 V Спирачка на колелата	1



Lescha
МИКСЕР ЗА БЕТОН



№	Характеристики	
35524	LB 354 230 V, 1,5 kW	1
35525	LB 354 400 V, 1,5 kW	1
35527	LB 354 Honda G200	1
35532	LB 404 230 V, 1,5 kW	1
35533	LB 404 400 V, 1,5 kW	1
35539	LB 484 Robin EH17B	1
35540	LB 484 Honda GX160LX	1
35542	AT 480 400 V, 1,2 kW	1

Lescha
МИКСЕР ЗА БЕТОН



№	Характеристики	
35518	S 230 HR- 230 I, 230 V Спирачка на колелата	1
35519	S 230 HR- 230 I, 400 V Спирачка на колелата	1

Lescha
МИКСЕР ЗА БЕТОН



№	Характеристики	
35552	LHB 1000 400 V	1
35553	LHB 1000 HATZ Diesel	1
35555	LHB 1200 400 V	1



ALTRAD
МИКСЕР ЗА БЕТОН



№	Характеристики	
37500	MIX 130Zk 230 V Разглобен	1
37501	MIX 130Z 230 V Сглобен	1
37505	MK 165Bk 230 V Разглобен	1
37506	MK 165B 230 V Сглобен	1

130 L

Характеристики	
Обем на барабана	130 l
Скорост на барабана	26±Min ⁻¹
Мощност	700 W
Напрежение	230 V / 50 Hz
Степен на защита	IP44
Материал на венца	Чугун
Размери	Дължина 1170 mm Широчина 650 mm Височина 1280 mm
Тегло	53 kg

165 L

Характеристики	
Обем на барабана	165 l
Скорост на барабана	23±Min ⁻¹
Мощност	900 W
Напрежение	230 V / 50 Hz
Степен на защита	IP44
Материал на венца	Чугун
Размери	Дължина 1295 mm Широчина 735 mm Височина 1440 mm
Тегло	70 kg



МЕШАЛИЦА МИКСЕР ЗА БЕТОН



125 L

Характеристики	
Обем на барабана	125 l
Скорост на барабана	26±Min ⁻¹
Мощност	550 W
Напрежение	230 V / 50 Hz
Степен на защита	IP44
Материал на венеца	Чугун
Размери	Дължина 1102 mm Широчина 690 mm Височина 1310 mm
weight Тегло	52,5 kg

№	Характеристики		
37509	126 l, 230 V	Сглобен	1
37510	126 l, 230 V	Разглобен	1

162 L

Характеристики	
Обем на барабана	162 l
Скорост на барабана	26±Min ⁻¹
Мощност	650 W
Напрежение	230 V / 50 Hz
Степен на защита	IP44
Материал на венеца	Чугун
Размери	Дължина 1180 mm Широчина 710 mm Височина 1310 mm
weight Тегло	56 kg

№	Характеристики		
37515	162 l, 230 V	Разглобен	1
37516	162 l, 230 V	Сглобен	1



РЪЧНА КОЛИЧКА



№	Характеристики		
37530	60 l, Ø 38 cm	Надуваема гума	1
37532	60 l, Ø 40 cm	Пневматична гума	1

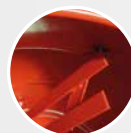

• Специално изработени остриета на раменете 4 mm



• Висококачествени лагери



• Превключвател със защита



• Пластмасов капак на двигателя, чугунен венец

142 L

Характеристики	
volume of drum Обем на барабана	142 l
drum speed Скорост на барабана	26±Min ⁻¹
power Мощност	650 W
voltage Напрежение	230 V / 50 Hz
degree of protection Степен на защита	IP44
material of chaplet Материал на венеца	Чугун
dimensions Размери	Дължина 1164 mm Широчина 690 mm Височина 1293 mm
weight Тегло	54 kg

№	Характеристики		
37511	142 l, 230 V	Разглобен	1
37512	142 l, 230 V	Сглобен	1

180 L

Характеристики	
Обем на барабана	180 l
Скорост на барабана	26±Min ⁻¹
Мощност	850 W
Напрежение	230 V / 50 Hz
Степен на защита	IP44
Материал на венеца	Litnový Чугун
Размери	Дължина 1164 mm Широчина 690 mm Височина 1368 mm
weight Тегло	58 kg

№	Характеристики		
37517	180 l, 230 V	Разглобен	1
37518	180 l, 230 V	Сглобен	1



РЪЧНА КОЛИЧКА, ГАЛВАНИЗИРАНА



№	Характеристики		
37527	80 l, Ø 40 cm	Пневматична гума	1
37533	80 l, Ø 38 cm	Надуваема гума	1

КОРПУС ЗА
РЪЧНА КОЛИЧКА,
ЧЕРЕН

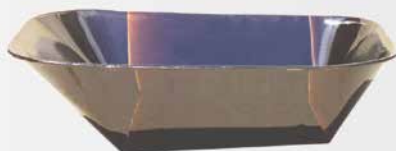

№	Характеристики	
37539	60 l	1

КОРПУС ЗА РЪЧНА
КОЛИЧКА,
ГАЛВАНИЗИРАН



№	Характеристики	
37541	80 l	1

РЕЗЕРВНИ ГУМИ



№	Характеристики	
48729	тип AA 400	Пневматична гума 1
48730	тип AA 380	Надуваема гума 1
48731	тип AA 380	Надуваема гума 1

РЪЧНА КОЛИЧКА
С ТРИ ГУМИ



№	Характеристики	
37564	60 l	1

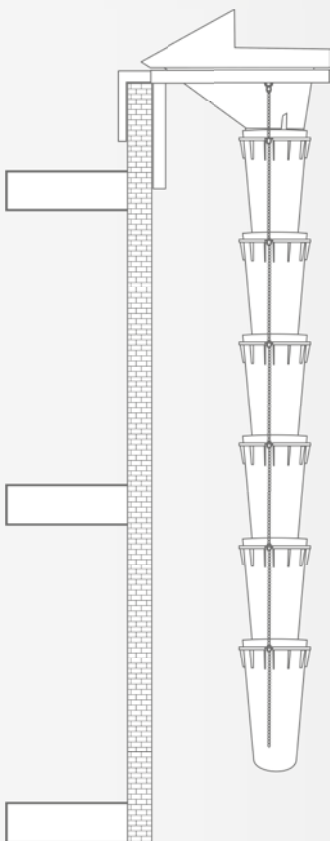

Lescha

УЛЕЙ ЗА СТРОИТЕЛНИ ОТПАДЪЦИ



№	Характеристики	
35603	Улей, базов, диаметър 50/40 см, дължина 108 см PE (HDPE)	1
35604	Пълнител за улей, пластмасов PE (HDPE)	1
35605	Рамка за улей,	1

HORIZONT®



HORIZONT®

МАСТАР

ALU

№	Характеристики	
15310	100 cm	10
15315	150 cm	10
15318	180 cm	10
15320	200 cm	10
15325	250 cm	10
15330	300 cm	10
15335	350 cm	10
15340	400 cm	10



HORIZONT®

МАСТАР НИВЕЛИР С 1 ЛИБЕЛА

ALU

№	Характеристики	
15415	150 cm	10
15418	180 cm	10
15420	200 cm	10
15425	250 cm	10
15430	300 cm	10



HORIZONT®

МАСТАР НИВЕЛИР С 2 ЛИБЕЛИ

ALU

№	Характеристики	
15510	100 cm	10
15515	150 cm	10
15518	180 cm	10
15520	200 cm	10
15525	250 cm	10
15530	300 cm	10
15535	350 cm	10
15540	400 cm	5



HORIZONT®

МАСТАР НИВЕЛИР С 2 РЪКОХВАТКИ, БЕЗ ЛИБЕЛИ

ALU

№	Характеристики	
15615	150 cm	10
15620	200 cm	10
15625	250 cm	10
15630	300 cm	10



HORIZONT®

МАСТАР НИВЕЛИР С 2 РЪКОХВАТКИ И 2 ЛИБЕЛИ

ALU

№	Характеристики	
15710	100 cm	10
15715	150 cm	10
15720	200 cm	10
15725	250 cm	10
15730	300 cm	10
15735	350 cm	10
15740	400 cm	5





HORIZONT

ТРАПЕЦОВИДЕН ПРОФИЛ

ТРАПЕЦОВИДЕН ПРОФИЛ

- Трапецовиден профил за фина шпакловка на мазилка
- Подходящ за мазилки и фасади
- Подходящ за тънкослойни покрития

ALU	№	Характеристики	
	15810	100 cm	10
	15812	120 cm	10
	15815	150 cm	10
	15818	180 cm	10
	15820	200 cm	10
	15825	250 cm	10
	15830	300 cm	10



HORIZONT

h-ПРОФИЛ

h-ПРОФИЛ

- h-профил за фина шпакловка на мазилка
- Подходящ за мазилки и фасади
- Подходящ за гипсови и циментови мазилки

ALU	№	Характеристики	
	15850	100 cm	10
	15853	150 cm	10
	15855	180 cm	10
	15860	200 cm	10
	15870	250 cm	10
	15880	300 cm	10



NEW

HORIZONT

СЪЕДИНИТЕЛ ЗА МАСТАР НИВЕЛИР

№	Характеристики		
15301		1	



HORIZONT

МАСТАР НИВЕЛИР С 1 ЛИБЕЛА РЕГУЛИРУЕМА

№	Характеристики		
15893	65 - 100 cm	1	
15894	95 - 150 cm	1	
15895	145 - 235 cm	1	



HORIZONT

ПРАВ ЪГЪЛ

ALU	№	Характеристики	
	14485	800 x 1200 mm	1
	14486	1000 x 1500 mm	1



**FESTA**

ОГЪВАЧ НА ПРЪТИ



№	Характеристики	
26730	Ø 6 - 14 mm	1
26731	Ø 5 - 8 mm	1



NEW

FESTA

СКОБА ЗА ПЛОЧКИ И ТУХЛИ



№	Характеристики	
60130	27 - 45 cm	10

NEW

**FESTA**

СКОБА ЗА ПЛОЧКИ И ТУХЛИ



№	Характеристики	
60132		1

NEW

FESTA

КОЛИЧКА ЗА ПАВЕТ

· max 150 kg



№	Характеристики	
60157		1



ОГЪВАЧ НА ПРЪТИ

№	Характеристики	
26735	max Ø 13 mm 56 cm	1

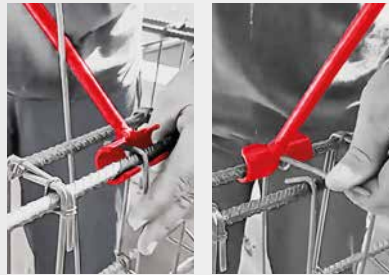

NEW

ОГЪВАЧ НА ПРЪТИ

· Ø 4-8 mm

№	Характеристики	
26736		1

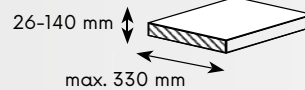

NEW

**FESTA**

РЕЗАЧКА ЗА ПЛОЧКИ

· max 45 kg

№	Характеристики	
60125		1



NEW

FESTA

КОЛИЧКА ЗА ПАВЕТ

· max 100 kg



№	Характеристики	
60155		1



30 - 50 cm

СКОБА ЗА ПЛОЧКИ И ТУХЛИ

№	Характеристики	
36310	max. 20kg	5



СКОБА ЗА БЕТОНЕНИ БЛОКОВЕ

Характеристики		60116
Захват		750-1000 mm
Макс. товар		120 kg

№	Характеристики	
60116	PRO 041	1



ЧУК ЗА ИЗРАВНЯВАНЕ НА БОРДЮРИ

Характеристики		60121	60123
Височина		200 mm	200 mm
Широчина		70 kg	70 kg
Дължина		870 mm	450 mm
Тегло		2,5 kg	2,2 kg

№	Характеристики	
60121	870 mm	1
60123	450 mm	1



СКОБА ЗА БЕТОНЕНИ БЛОКОВЕ

Характеристики		60115
Захват		80-370 mm
Макс. товар		50 kg

№	Характеристики	
60115	PRO 040	1



СКОБА ЗА БЕТОНЕНИ БЛОКОВЕ

Характеристики		60117	60118
Захват		500-1000 mm	0-500 mm
Макс. товар		150 kg	150 kg

№	Характеристики	
60117	PRO 042	1
60118	PRO 043	1



ПОДЛОЖКА ЗА ПОДОВИ НАСТИЛКИ

№	Характеристики	
37166	D10 основа	25



МАКАРА ЗА ВДИГАНЕ НА ТЕЖЕСТИ

№	Характеристики	
26780	0,5 t A С кука	1
26781	0,5 t B С око	1
26782	0,5 t C С кука и протектор	1
26783	0,5 t D С око и протектор	1

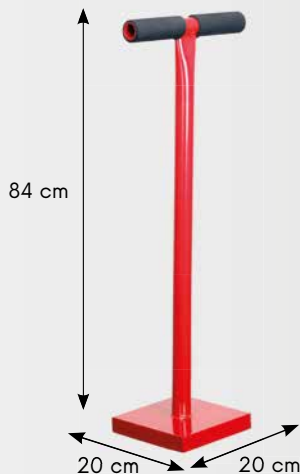

РЪЧНА ТРАМБОВКА

№	Характеристики	
26740	12 kg	1



РЪЧНА КОЛИЧКА

№	Характеристики	nosnost	
48719	260 mm Колело	250 kg	1



ПРОФЕСИОНАЛНА МАШИНА ЗА РЯЗАНЕ НА ПЛОЧКИ

- Машина за рязане на плочки за най-взискателна работа
- Каретка с 9 сачмени SKF лагера, 4 от които - регулируеми
- Възможност за настройка за работа с лява ръка
- Гарантирани резервни части и сервис
- Режещо колело от хром-волфрамова стомана.

SUPER PRO



МАШИНИ ЗА РЯЗАНЕ НА ПЛОЧКИ SUPER PRO „EVO“

• 36195 Резервно режещо колело - Ø 22 mm



№	Характеристики
36191	1250 mm

1



SUPER PRO



МАШИНИ ЗА РЯЗАНЕ НА ПЛОЧКИ SUPER PRO

• 36195 Резервно режещо колело - Ø 22 mm



№	Характеристики	
36145	SUPER PRO 450 mm	1
36160	SUPER PRO 600 mm	1
36175	SUPER PRO 750 mm	1
36190	SUPER PRO 900 mm	1



• Илюстративна снимка

СТЕЛАЖ ЗА МАШИНИ ЗА РЯЗАНЕ НА ПЛОЧКИ SUPER PRO



№	Характеристики	
36200	Стелаж	1
36199	Стелаж с артикули 36160, 36175, 36190	1



FESTA

МАШИНА ЗА РЯЗАНЕ НА ПЛОЧКИ

· 36138 Резервно режещо колело - Ø 22 mm



№	Характеристики	
36085	600 mm	1
36087	900 mm	1
36086	1300 mm	1



FESTA

МАШИНА ЗА РЯЗАНЕ НА ПЛОЧКИ

· 36139 Резервно режещо колело - Ø 22 mm



№	Характеристики	
36102	1050 mm	1
36103	1300 mm	1
36105	1550 mm	1



FESTA

МАШИНА ЗА РЯЗАНЕ НА ПЛОЧКИ

· 36195 Резервно режещо колело - Ø 22 mm



№	Характеристики	
36080	600 mm	1
36081	750 mm	1
36082	900 mm	1
36076	750 mm Сглобен	1
36077	900 mm Сглобен	1



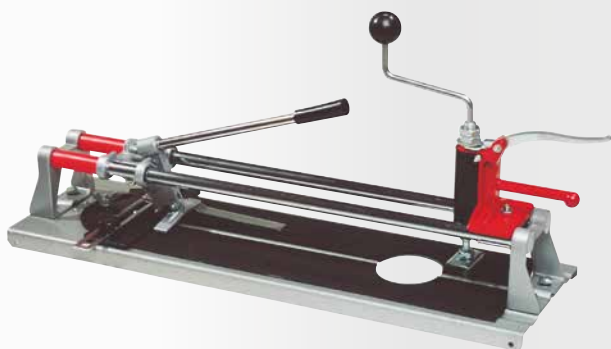

МАШИНА ЗА РЯЗАНЕ НА МОЗАЕЧНИ ПЛОЧКИ

• 36128 Резервно режещо колело - Ø 16 mm



№	Характеристики	
36014	480 mm	4

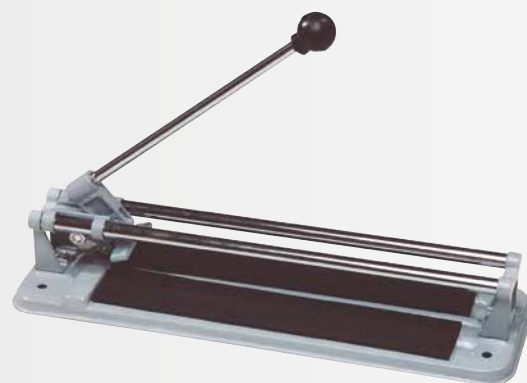

МАШИНА ЗА РЯЗАНЕ НА ПЛОЧКИ

• 36126 Резервно режещо колело - Ø 15 mm



№	Характеристики	
36024	300 mm	10
36034	400 mm	10
36035	600 mm	4

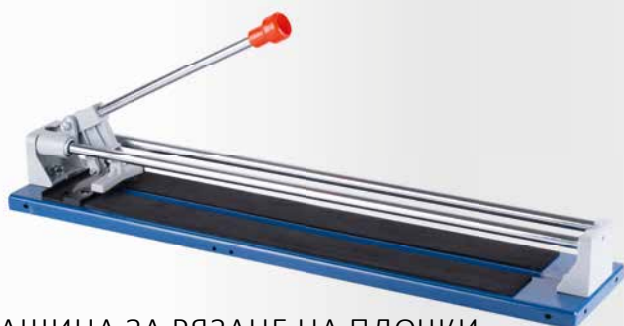

МАШИНА ЗА РЯЗАНЕ НА ПЛОЧКИ

• 36136 Резервно режещо колело - Ø 22 mm



№	Характеристики	
36036	480 mm	1



ИНСТРУМЕНТ ЗА РЪЧНО РЯЗАНЕ НА ПЛОЧКИ

• 36136 Резервно режещо колело - Ø 22,2 mm



№	Характеристики	
36046	22 mm	1

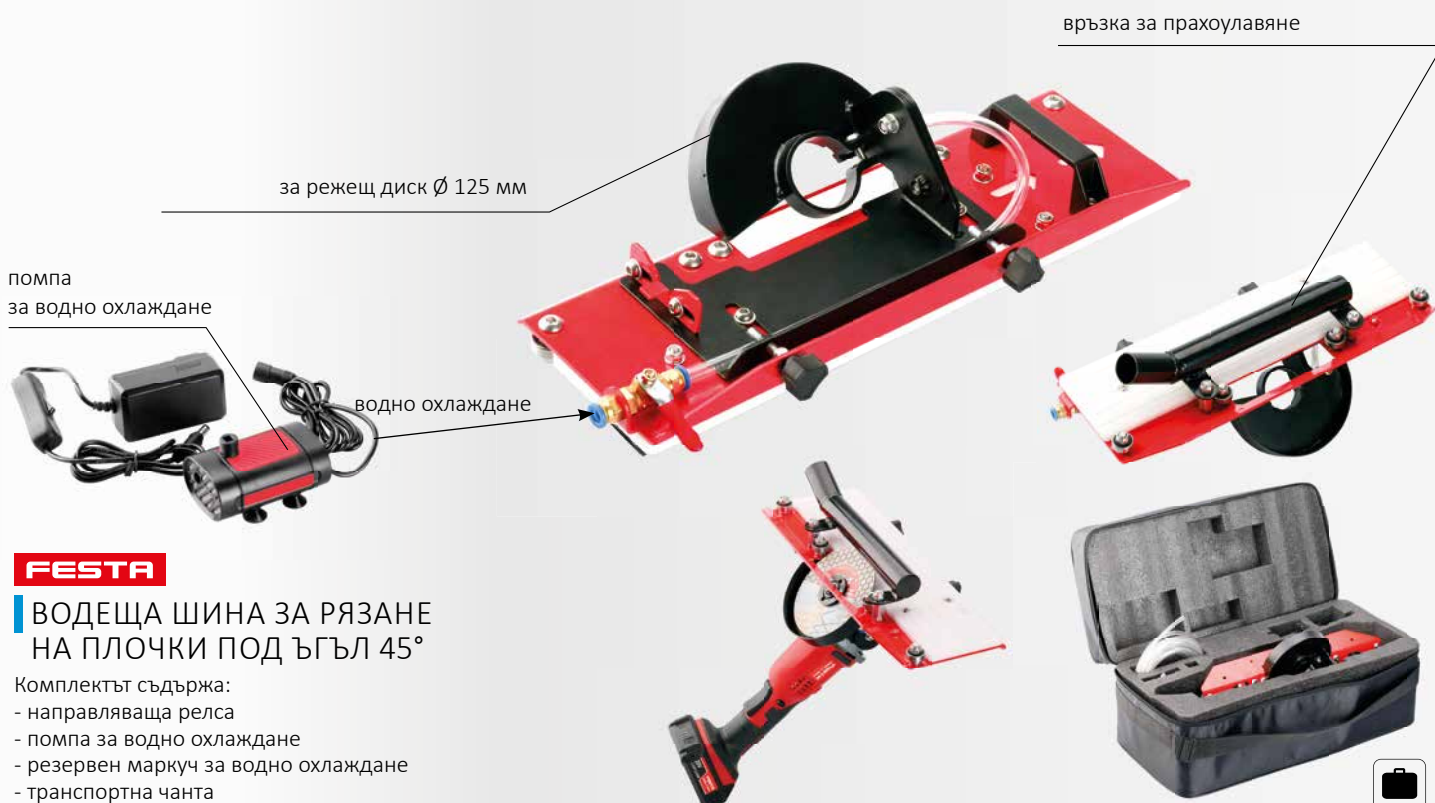

FESTA

ВОДЕЩА ШИНА ЗА РЯЗАНЕ НА ПЛОЧКИ ПОД ЪГЪЛ 45°

Комплектът съдържа:

- направляваща релса
- помпа за водно охлаждане
- резервен маркуч за водно охлаждане
- транспортна чанта

№	Характеристики
24680	





РЕЗЕРВНО КОЛЕЛО ЗА РЯЗАНЕ НА ПЛОЧКИ



Број	спецификација	
36126	a= Ø 15 mm, b= Ø 6 mm, c= 1,5 mm	1
36128	a= Ø 16 mm, b= Ø 6 mm, c= 3 mm	1
36130	a= Ø 20 mm, b= Ø 6 mm, c= 5 mm	1
36136	a= Ø 22 mm, b= Ø 6 mm, c= 2 mm	1
36138	a= Ø 22 mm, b= Ø 6 mm, c= 5 mm	1
36139	a= Ø 22 mm, b= Ø 6 mm, c= 6 mm	1
36195	a= Ø 22 mm, b= Ø 6 mm, c= 4,8 mm	1



НОЖ ЗА РЯЗАНЕ НА ПЛОЧКИ

№	Характеристики	
24055	Karbid- BOSCH, MAKITA	1



FESTA

КЛЕЩИ ЗА РЯЗАНЕ НА ПЛОЧКИ



№	Характеристики	
36057	200 mm	6

КЛЕЩИ ЗА РЯЗАНЕ НА ПЛОЧКИ



№	Характеристики	
36056		10



КЛЕЩИ ЗА РЯЗАНЕ НА ПЛОЧКИ



№	Характеристики	
36059		1

КЛЕЩИ ЗА ОФОРМЯНЕ НА ПЛОЧКИ



№	Характеристики	
36058	200 mm	6

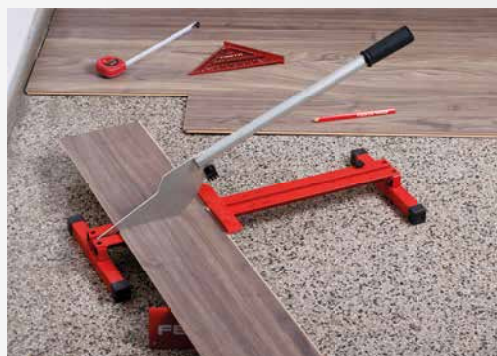

FESTA

НОЖ ЗА РЯЗАНЕ НА ЛАМИНАТ И ВИНИЛ



№	Характеристики	
36140	210 mm	4



NEW



FESTA

АПЛИКАТОР ЗА СИЛИКОН



№ Характеристики

37050

1



FESTA

АПЛИКАТОР ЗА СИЛИКОН



№ Характеристики

16056

145 mm

50

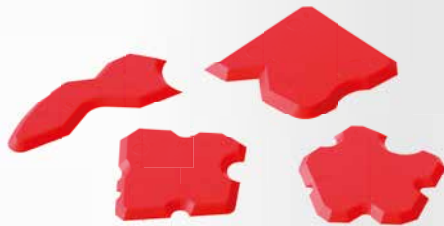

КОМПЛЕКТ АПЛИКАТОРИ ЗА СИЛИКОН

4x



№ Характеристики

37052

1



КОМПЛЕКТ АПЛИКАТОРИ ЗА СИЛИКОН

4x



№ Характеристики

37053

48



АПЛИКАТОР ЗА СИЛИКОН

№ Характеристики

37054



1



АПЛИКАТОР ЗА СИЛИКОН

· За прозорци

№ Характеристики

37055



1



ДЪРВЕНА ШПАТУЛА С ГУМА

№ Характеристики

37011

180 mm



12

37021

280 mm

12



37028



37029



37025



37026

ГЪБА ЗА ПОЧИСТВАНЕ 160 X 110 X 60 MM

№ Характеристики

37028

хидрогъба



1

37029

Морска гъба

1

ГЪБА ЗА ПОЧИСТВАНЕ 200 X 100 X 100 MM

№ Характеристики

37025

Мек дунапрен



1

37026

Морска гъба

1

ВАНИЧКА

№ Характеристики

37117

Комплект



1

90070

Вана 25 l

1

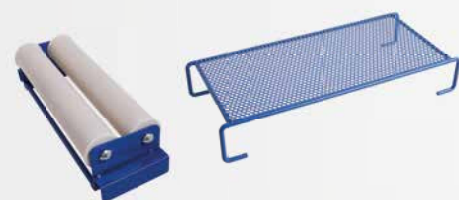

ПРИБОРИ ЗА ВАНИЧКА

№ Характеристики

90072

Решетка



1

90071

Метални валеци

1



СТЪРГАЛО ЗА ФУГИ

№	Характеристики	Икона
37012		1



СТЪРГАЛО ЗА ФУГИ С КАРБИДНО ОСТРИЕ

№	Характеристики	Икона
37006	30 mm	20
37007	50 mm	20
37008	Резервно острие 30 mm	50
37009	Резервно острие 50 mm	50



КОМПЛЕКТ ЗА ПОСТАВЯНЕ И ОТСТРАНЯВАНЕ НА СИЛИКОН

№	Характеристики	Икона
16042		12

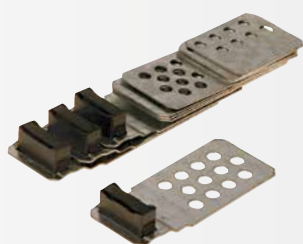

МАГНИТИ ЗА ПЛОЧКИ



№	Характеристики	Икона
38920		1



МАГНИТИ ЗА ПЛОЧКИ, РЕГУЛИРУЕМИ



№	Характеристики	Икона
38923		24



ЪГЛИ, СТРОИТЕЛЕН

№	Характеристики	Икона
38919		50



ФУГИРАЦ ПИСТОЛЕТ

· objem 1,5 l



№	Характеристики	Икона
38026	5x накрайника	25



КОМПЛЕКТ ТОРБИЧКА ПОШ



№	Характеристики	Икона
38042	3x накрайника	6

NEW

- Ø 10 mm
- Ø 14 mm
- Ø 20 mm
- Ø 10 x 35 mm

FESTA

АПЛИКАТОР



№	Характеристики	Икона
38045		1



МОНТАЖЕН КОМПЛЕКТ ЗА ЛАМИНАТ

24x

№	Характеристики	Бр.	Пакет
52130		1	1



МОНТАЖНИ КЛИНОВЕ, ПЛАСТМАСОВИ

50x

№	Характеристики	Бр.	Пакет
37210	95 x 45 x 15- 0 mm	50	1
37211	70 x 30 x 8- 0 mm	50	1



МОНТАЖНА ВЪЗГЛАВНИЦА

- Размери 15x17 cm
- Макс. височина 5 cm

№	Характеристики	Бр.	Пакет
37220		1	1

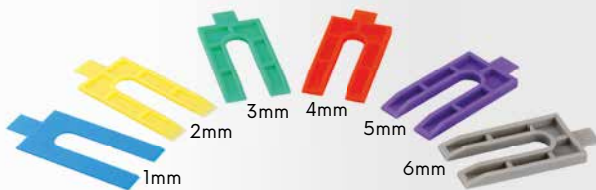

ДИСТАНЦИОННИ ЕЛЕМЕНТИ

30x

№	Характеристики	Бр.	Пакет
37212	1- 6 mm, 5x от всякакъв размер	1	1

FESTA

МОНТАЖНИ КЛИНОВЕ, ДЪРВЕНИ



№	Характеристики	Бр.	Пакет
37204	55 x 20 x 0- 6 mm	20	1
37203	65 x 18 x 0- 12 mm	20	1
37202	80 x 25 x 3- 10 mm	20	1
37201	100 x 25 x 1- 16 mm	14	1
37200	150 x 25 x 1- 25 mm	8	1



FESTA

КЛИНОВЕ ЗА ПЛОЧКИ

№	Характеристики	Бр.	Пакет
37155	0- 8 mm	30	100
37156	0- 4 mm	100	100
37157	2,5- 8 mm	30	100



FESTA

КЛИНОВЕ ЗА ПЛОЧКИ

250x

№	Характеристики	Бр.	Пакет
37205	55 x 8 x 0- 10 mm	250	1



NEW

NIVELYS
LEVELING SYSTEM
FESTA

ФУНДАМЕНТЕН ПРОФИЛ ПОД ОБЛОЖКА

ALU

№	Характеристики	Бр.	Пакет
37105	50 cm	1	1
37106	100 cm	1	1
37107	150 cm	1	1



NEW

NIVELYS
LEVELING SYSTEM
FESTA

РЕГУЛИРУЕМИ КРАКА ЗА ФУНДАМЕНТЕН ПРОФИЛ

- max. 50 kg

2x

№	Характеристики	Бр.	Пакет
37102		1	1

NIVELYS

LEVELING SYSTEMS

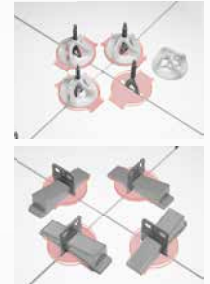

NIVELYS
LEVELING SYSTEMS FESTA

РЕЗБОВАН ДИСТАНЦИОНЕН КЛИПС

50x

№	Характеристики	Бр.
37131	1 mm	40
37132	2 mm	40

NIVELYS
LEVELING SYSTEMS FESTA

НИВЕЛИРАЩА ШАПКА С КОНЕЦ

50x

№	Характеристики	Бр.
37130		15

NIVELYS
LEVELING SYSTEMS FESTA

ПРЕДПАЗНИ ПЛОЧИ ЗА СИСТЕМИ ЗА НИВЕЛИРАНЕ НА ПЛОЧКИ

100x

№	Характеристики	Бр.
37192		1

NIVELYS
LEVELING SYSTEMS FESTA

ДИСТАНЦИОНЕРИ

· нивелиращи клинове 37115, 37176

50x

№	Характеристики	Бр.
37170	1 mm	50
37171	2 mm	50
37172	3 mm	50

NIVELYS
LEVELING SYSTEMS FESTA

ДИСТАНЦИОНЕРИ

100x

№	Характеристики	Бр.
37185	1 mm	100
37190	1,5 mm	100
37186	2 mm	100

№	Характеристики	Бр.
37187	3 mm	100
37188	4 mm	100
37189	5 mm	100

NIVELYS
LEVELING SYSTEMS FESTA

ДИСТАНЦИОНЕРИ

100x

№	Характеристики	Бр.
37162	1,5 mm	1

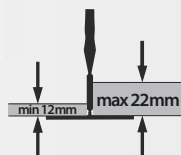

NIVELYS
LEVELING SYSTEMS FESTA

НИВЕЛИРАЩИ КЛИНОВЕ

№	Бр.
37175	50
37176	400



NIVELYS
LEVELING SYSTEMS FESTA

NIVELYS
LEVELING SYSTEMS **FESTA**

ДИСТАНЦИОНЕРИ

600x

№	Характеристики	бр.	krabice	
37125	1 mm	600	38 x 28 x 19 cm	1
37126	1,5 mm	600	38 x 28 x 19 cm	1
37127	2 mm	600	38 x 28 x 19 cm	1

NIVELYS
LEVELING SYSTEMS **FESTA**

ДИСТАНЦИОНЕРИ + НИВЕЛИРАЩИ КЛИНОВЕ

№	Характеристики	
37173	1 mm, 400 бр. + 200 бр.	1
37174	1,5 mm, 400 бр. + 200 бр.	1

NIVELYS
LEVELING SYSTEMS **FESTA**

КЛЕЩИ ЗА НИВЕЛИРАНЕ НА ПЛОЧКИ

№	
37177	1

NIVELYS
LEVELING SYSTEMS **FESTA**

КЛЕЩИ ЗА НИВЕЛИРАНЕ НА ПЛОЧКИ

№	
37178	1

СИСТЕМА ЗА НИВЕЛИРАНЕ НА ПЛОЧКИ

50x

№ No.	Характеристики Specification	
37199	1,5 mm	40

NIVELYS
LEVELING SYSTEMS **FESTA**

КРЪСТЧЕТА ЗА ФУГИ

100x

№	Характеристики	бр.	
37195	1,0 mm	100	12
37196	1,5 mm	100	12
37197	2 mm	100	12
37198	3 mm	100	12

FESTA

КРЪСТЧЕТА ЗА ФУГИ

№	Характеристики	бр.	
37148	1,0 mm	200	100
37149	1,5 mm	200	100
37150	2 mm	200	100
37151	2,5 mm	200	100
37152	3 mm	150	100
37153	4 mm	100	100
37154	5 mm	75	100
37158	10 mm	30	100

FESTA

КРЪСТЧЕТА ЗА ФУГИ

100x

№	Характеристики	
37285	1,5 mm	100
37286	2 mm	100
37287	2,5 mm	100
37288	3 mm	100
37289	4 mm	100

NEW

Хоризонтална 110 kg
 Вертикална 80 kg
 Ø 220 mm
 USB-C

FESTA
 POWER X TOOLS

ВАКУУМНА ВЕНДУЗА

Li-ion 3.6V 2Ah

№ 36326

Размери

FESTA

ДЪРЖАЧ ЗА ПЛОЧКИ С ИНДИКАТОР ЗА ВАКУУМ

Ø 200 mm 140 kg 100 kg

ROUGH SURFACE

№ 36325

Характеристики

FESTA

ВАКУУМНА ЛАПА ЗА СЪГЪЛО

Позиция	Товароподемност
Хоризонтална	120 kg
Вертикална	150 kg

ALU

№ 36318

Характеристики

тройна 10

FESTA

ВАКУУМНА ЛАПА ЗА СЪГЪЛО

Позиция	Товароподемност
Хоризонтална	80 kg
Вертикална	100 kg

ALU

№ 36313

Характеристики

Двойна 20

FESTA

ВАКУУМНА ЛАПА ЗА СЪГЪЛО

Позиция	Товароподемност
Хоризонтална	50 kg
Вертикална	50 kg

ALU

№ 36314

Характеристики

Единична 20

ЛАПА ЗА СЪГЪЛО, ВАКУУМНА

№ 36305

Характеристики

Единична 60

ЛАПА ЗА СЪГЪЛО, ВАКУУМНА

№ 36306

Характеристики

Двойна 20

ЛАПА ЗА СЪГЪЛО, ВАКУУМНА

Позиция	Товароподемност
Хоризонтална	80 kg
Вертикална	100 kg

№ 36319

Характеристики

тройна 10

**FESTA**

ЧЕРТИЛКА 30 М С ПУДРА 120 G

- 6 пъти по-бързо навиване
- функция с отвесна линия

№
37070

6

**FESTA**

ЧЕРТИЛКА 30 М С ПУДРА 150 G

- 5x 5 пъти по-бързо навиване

№
37065

6



ЧЕРТИЛКА 30 М С ПУДРА 180 G

№
37069

10



ЧЕРТИЛКА, ПЛАСТМАСОВА, 30 М

№
37066

25



ЧЕРТИЛКА, МЕТАЛНА, 30 М

ALU№
37068

25



ЧЕРТИЛКА, ПЛАСТМАСОВА, ABS, 30 М

№
37067

25

**FESTA**

ПУДРА ЗА ЧЕРТИЛКА 180 G

№	Характеристики	
37096	Синя	10
37094	Светлосиня	10
37097	Червена	10
37095	Светлочервена	10
37098	Черна	10

**FESTA**

ЗИДАРСКИ КОНЕЦ ЧЕРВЕН

№
38895Характеристики
50 m

24

38896

100 m

24

**FESTA**

ЗИДАРСКИ КОНЕЦ ЖЪЛТ

№
38899Характеристики
50 m

24

38900

100 m

24

**FESTA**

ЗИДАРСКИ КОНЕЦ, ПОЛИЕТИЛЕН, 50 М

№	Характеристики	
38907	Червен 1,0 mm	100
38908	Червен 1,7 mm	100
38909	Червен 2,0 mm	100



FESTA

ЗИДАРСКИ КОНЕЦ,
ПОЛИЕТИЛЕН, 50 М

№	Характеристики	
38904	Жълт 1,0 mm	100
38905	Жълт 1,7 mm	100
38906	Жълт 2,0 mm	100



FESTA

ЗИДАРСКИ КОНЕЦ,
ПОЛИЕТИЛЕН, 50 М

№	Характеристики	
38910	Оранжев 1,0 mm	100
38911	Оранжев 1,7 mm	100
38912	Оранжев 2,0 mm	100



FESTA

ЗИДАРСКИ КОНЕЦ,
ПОЛИЕТИЛЕН, 50 М

№	Характеристики	
38901	Бял 1,0 mm	100
38902	Бял 1,7 mm	100
38903	Бял 2,0 mm	100



ВОСЪЧЕН ШНУР



№	Дължина	Ø	
50920	50 m	1 mm	80



FESTA

ОТВЕС С КАНАП, 15 М



№	Характеристики	
38916	150 g	10
38917	300 g	6
38918	500 g	5

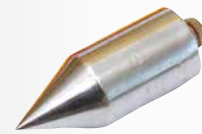

FESTA

ОТВЕС



№	Характеристики	
38913	150 g	10
38914	300 g	10
38915	500 g	10

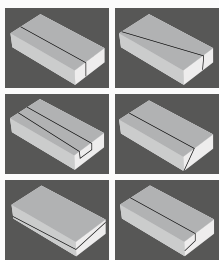

**FESTA****ЕЛЕКТРИЧЕСКИ НОЖ ЗА ПОЛИСТИРЕН**

- Напрежение 230 V/50 Hz
- Консумация на енергия 200 W
- Работна дължина 137 cm
- Работна височина 30 cm
- Защита IP44
- Ъгъл на рязане 0° - 90°
- Окомплектовка: стойка, крачен превключвател, държач за скели, 2x Ni-Cr режеща тел, почистваща месингова четка, инструменти и крепежни елементи, пластмасова кутия с колела



№ 35348

Характеристики

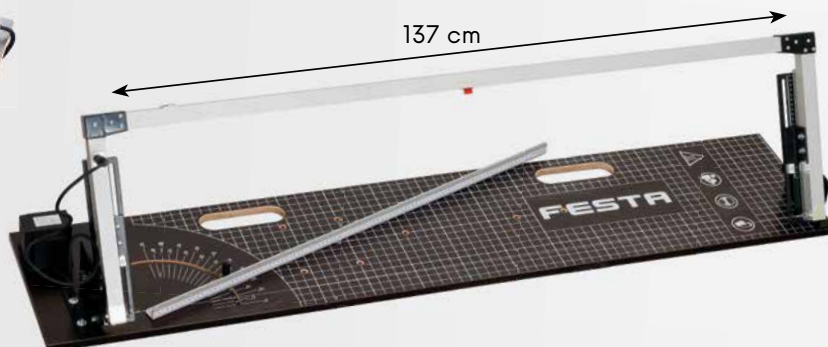
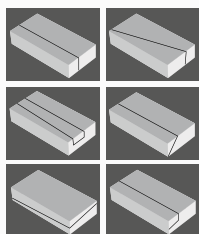

1

**FESTA****ЕЛЕКТРИЧЕСКИ НОЖ ЗА ПОЛИСТИРЕН**

- Напрежение 230 V / 50 Hz
- Консумация на енергия 200 W
- Работна дължина 137 cm
- Работна височина 30 cm
- Защита IP44
- Ъгъл на рязане 0° - 90°



· Окомплектовка: Ni-Cr режеща тел, прибор за почистване, четка

№ 35345

Характеристики



1

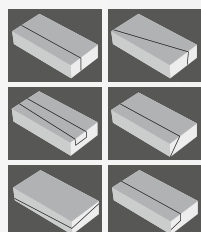

FESTA

ЕЛЕКТРИЧЕСКИ НОЖ ЗА ПОЛИСТИРЕН

- Напрежение 230 V / 50 Hz
- Консумация на енергия 160 W
- Работна дължина 120 cm
- Работна височина 52 cm
- Защита IP44
- Ъгъл на рязане 0° - 90°



· Окомплектовка: Ni-Cr режеща тел, прибор за почистване, четка

№ Характеристики

35344

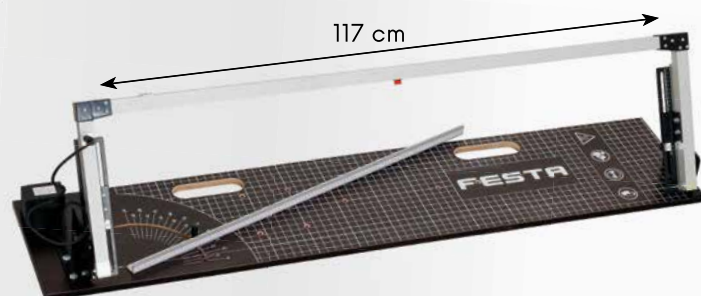
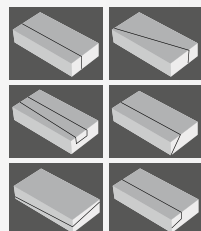

FESTA

ЕЛЕКТРИЧЕСКИ НОЖ ЗА ПОЛИСТИРЕН

- Напрежение 230 V / 50 Hz
- Консумация на енергия 160 W
- Работна дължина 120 cm
- Работна височина 30 cm
- Защита IP44
- Ъгъл на рязане 0° - 90°



· Окомплектовка: Ni-Cr режеща тел, прибор за почистване, четка

№ Характеристики

35330



**FESTA**

КРАЧЕН ПЕДАЛ ЗА РЕЗАЧКА ЗА ПОЛИСТИРОЛ

за 35330, 35345, 35348



1

**FESTA**

СТОЙКА ЗА РЕЗАЧКА ЗА ПОЛИСТИРОЛ

за 35330, 35345, 35348



1

**FESTA**

РЕЗЕРВНА ПРУЖИНА ЗА РЕЗАЧКА ЗА ПОЛИСТИРОЛ

за 35330, 35345, 35348



1

**FESTA**

ДЪРЖАЧ ЗА СКЕЛЕ ЗА РЕЗАЧКА ЗА ПОЛИСТИРОЛ

за 35330, 35345, 35348



1

**FESTA**

РЕЗЕРВНИ АДАПТЕР ЗА НАПАЈАЊЕ ЗА РЕЗАЧКА ЗА ПОЛИСТИРОЛ

за 35330, 35345, 35348



Напрежение: 230 V / 50Hz

излаз: 36 V / 5 A

Консумация на енергия: 200 W



1

35347

НИ-ЦР ОТПОРНА ЖИЦА ЗА РЕЗАЧКА ЗА ПОЛИСТИРОЛ



1

№	Характеристики
35331	за резачка 117 cm
35346	за резачка 137 cm





FESTA

АКУМУЛАТОРЕН НОЖ ЗА ПОЛИСТИРОЛ

- батерия 36 V, 1,5Ah Li-ion
- консумация на енергия 180 W
- температура max 350 C°
- дължина на ножа 20 cm
- оборудване: 2 батерии, зарядно устройство, острие, месингова четка за почистване, шестостен



№	Характеристики	
35323	Електрически нож за полистирен	1
35328	Резервен нож с дължина 14 cm	1
35329	Резервен нож с дължина 25 cm	1

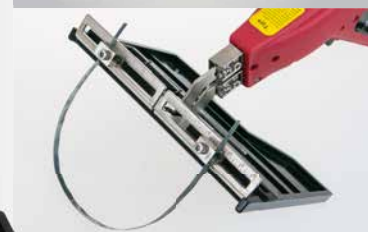

FESTA

ЕЛЕКТРИЧЕСКИ НОЖ ЗА ПОЛИСТИРЕН

- Напрежение 230 V/50 Hz
- Консумация на енергия 250 W
- Температура 50-600 C°
- Дължина на ножа 25 cm
- Захранващ кабел 3 m



· Окомплектовка: режеща тел 25cm + 30cm, прибор за почистване

№	Характеристики	
35326	Електрически нож за полистирен	1
35328	Резервен нож с дължина 14 cm	1
35329	Резервен нож с дължина 25 cm	1



НАПРАВЛЯВАЩА ШИНА ЗА РЯЗАНЕ НА ПОЛИСТИРЕН



№	Характеристики	
35327	Направляваща шина	1
35335	Резервен нож с дължина - 30 cm	1

FESTA

ЕЛЕКТРИЧЕСКИ НОЖ ЗА ПОЛИСТИРЕН



· С регулация на температурата

№	Характеристики	
35325	220 W	1



FESTAФРЕЗА
ЗА ПОЛИСТИРЕН

ALU

№	Характеристики	
24752	Ø 65 mm	1
24753	Ø 70 mm	1



ФРЕЗА ЗА ПОЛИСТИРЕН

№	Характеристики	
24727	Ø 65 mm	1
24729	Ø 68 mm	1
24728	Ø 70 mm	1

ДЮБЕЛ
ЗА ФАСАДА

100x

MADE IN
EU

№	Характеристики		№	Характеристики	
39210	Ø 10 x 100 mm	1	39218	Ø 10 x 180 mm	1
39212	Ø 10 x 120 mm	1	39217	Ø 10 x 200 mm	1
39214	Ø 10 x 140 mm	1	39219	Ø 10 x 220 mm	1
39216	Ø 10 x 160 mm	1			

**FESTA**ДЮБЕЛ В ИЗОЛАЦИЯТА ЗА
ВТУЛКИ ЗА ВОДЕЩИ ВИНТОВЕ

2x

№	Характеристики	
39240	бяло M10	1
39241	сиво M10	1
39242	антрацит M10	1
39243	кафяво M10	1
39244	черен M10	1

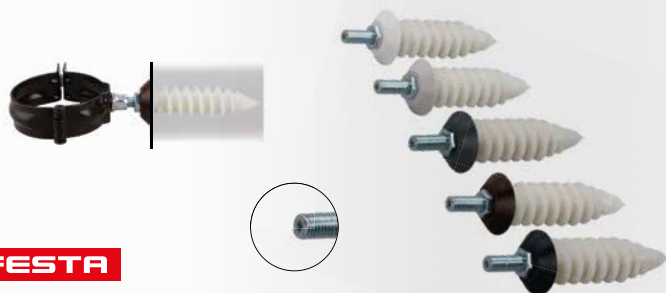

ИЗОЛАЦИОННА ШАЙБА

за винтове Ø 6 и 8 mm

50x

№	Характеристики	
39208	Ø 68 mm	1



ИЗОЛАЦИОННА ШАЙБА

№	Характеристики	
39206	Ø 40 mm	200
39207	Ø 60 mm	100



MOQ

ВАЛЯК ЗА ОБЕЗВЪЗДУШАВАНЕ

MADE IN
EU

№	Диаметър	Височина hrotú	Дължина	
38950	Ø 69 mm	12 mm	25 cm	10
38951	Ø 69 mm	12 mm	40 cm	8
38952	Ø 122 mm	34 mm	25 mm	10
38953	Ø 122 mm	34 mm	40 cm	8
38954	Ø 122 mm	34 mm	60 mm	4

ПОДМЕТКИ
С ШИПОВЕMADE IN
EU

№	Характеристики	
38970	Spikes 25 mm	1
38971	Spikes 30 mm	1





МЕТАЛНИ ШАЙБИ



№	Характеристики	
42420	Ø 30 mm	1



МЕТАЛНА МРЕЖА



№	Характеристики	
42312	1 m 50 bm 16 x 16 mm	1

ДЪРВЕН МАСТАР



№	Дължина	Дебелина	Широчина	
37120	200 mm	1,7 mm	20 mm	10
37119	250 mm	1,7 mm	20 mm	10



ЛИСТ



№	Широчина	Височина	oko sita	
37216	50 mm	50 mm	2 mm	1
37217	50 mm	50 mm	3 mm	1
37218	50 mm	50 mm	4 mm	1

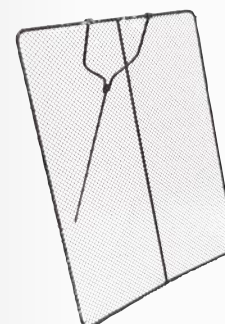

ЛИСТ

№	Широчина	Височина	oko sita	
37236	0,8 m	1 m	10 mm	1
37237	0,8 m	1 m	12 mm	1
37238	0,8 m	1 m	16 mm	1
37239	0,8 m	1 m	20 mm	1



ФИБРИ ЗА БЕТОНОВИ И ХОРОСАНОВИ СМЕСИ

- +/- 150 g/ 50 kg цимент
- 600 - 900 g/m² бетон или хоросан



№	váha	
42115	0,9 kg	9



P.E. МРЕЖА ЗА СКЕЛЕ

№	Характеристики	
42120	2,5 x 20 m, 80 g/ m ² zelená	5



РЪЧНА МАШИНА ЗА МАЗИЛКИ



№	Характеристики	
37114		1



РЪЧНА МАШИНА ЗА МАЗИЛКИ



№	Характеристики	
37115		1



СКОБА ЗА ФИКСИРАНЕ, ПОЦИНКОВАНА

Zn		MOQ 10	
№	Характеристики		
37231	14 cm самостоятелна	10	



СКОБА ЗА ФИКСИРАНЕ, КОВАНА

		MOQ 5	
№	Характеристики		
37232	14,5 cm	5	



КОМПЛЕКТ СКОБИ ЗА ФИКСИРАНЕ

6x			
№	Характеристики		
37230	16 cm	6	

СКОБА ЗА СВЪРЗВАНЕ НА ГРЕДИ, ПОЦИНКОВАНА

Zn			
№	Характеристики		
37233	320 x 10 mm	100	
37234	320 x 12 mm	100	



СКОБА ЗА СВЪРЗВАНЕ НА ГРЕДИ

№	Характеристики		
37235	250 x 12 mm	1	



АЛУМИНИЕВ ЪГЪЛ

ALU			
№	Характеристики		
39245	AL 30 m x 5 cm	1	



ПЛАСТМАСОВ ЪГЪЛ

MADE IN EU			
№	Характеристики		
39238	3 m	25	



ШПАКЛА ЗА ГИПСОКАРТОН

PLASTIC			
№	Характеристики		
34308	50 mm	20	
34307	80 mm	12	
34306	100 mm	10	
34305	150 mm	12	



СТОЙКА ЗА ПОСТАВЯНЕ И ПОВДИГАНЕ НА ГИПСОКАРТОН

№	Характеристики		
26775	153 - 344 cm max. 54 kg	1	



КОМПЛЕКТ ЗА ГИПСОКАРТОН

№	Характеристики		
34300	Броя 9 бр.	10	
34303	Ваничка	60	



FESTA

ДЪРЖАЧИ ЗА НОСЕНЕ НА ДЪСКА

2x			
№	Характеристики		
36312		12	



FESTA

ДЪРЖАЧ ЗА ДЪСКИ И ГИПСОКАРТОН

№	Характеристики		
36308	36 x 16,5 x 7,5 cm	10	





РЕНДЕ ЗА ГИПСОКАРТОН (РАШПИЛА)

№	Характеристики	Икона
22120	250 x 40 mm	10



РЕНДЕ ЗА ГИПСОКАРТОН (РАШПИЛА)

№	Характеристики	Икона
22121	250 x 40 mm	10
22122	140 x 40 mm	6



РЕНДЕ ЗА ГИПСОКАРТОН (РАШПИЛА)

№	Характеристики	Икона
22126	155 x 40 mm	1



РЕНДЕ ЗА ГИПСОКАРТОН (РАШПИЛА)

№	Характеристики	Икона
22125	Ø 250 x 40 mm	6



РЕНДЕ ЗА ГИПСОКАРТОН (РАШПИЛА)

№	Характеристики	Икона
22124	Ø 250 x 16 mm	10



РЕНДЕ ЗА ГИПСОКАРТОН (РАШПИЛА)

№	Характеристики	Икона
22123	60 x 40 mm	6



ТРИОН ЗА ГИПСОКАРТОН

№	Характеристики	Икона
24159	150 mm	12



РЕНДЕ ЗА ГИПСОКАРТОН, ЪГЛОВО

№	Характеристики	Икона
34315		10
34316	Резервно острие	1



ПРОБОДЕН ТРИОН ЗА ГИПСОКАРТОН

№	Характеристики	Икона
24190	300 mm	10

РЕЗЕРВИ ЗА РЕНДЕ ЗА ГИПСОКАРТОН

№	Характеристики	Икона
22130	250 x 40 mm	20
22129	155 x 40 mm	20
22132	140 x 40 mm	20
22133	60 x 40 mm	20
22134	Ø 16 x 250 mm	20



FESTA

ГОРЕЛКА ЗА ПОДГРЯВАНЕ

· Ø 17, 22, 40 mm



№	Характеристики	
69918	2 kW, 3 m маркуч	10

**FESTA**

ГОРЕЛКА ЗА ПОДГРЯВАНЕ

· Ø 25, 35, 50 mm



№	Характеристики	
69919	19,5 kW, 1,5 m маркуч	10

**FESTA**

ГОРЕЛКА ЗА ПОДГРЯВАНЕ 300 MM

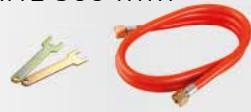

№	Характеристики	
69900	Ø 35 mm, Дължина 300 mm, без маркуч	10
69901	Ø 35 mm, Дължина 300 mm + 3 m маркуч	5

**FESTA**

ГОРЕЛКА ЗА ПОДГРЯВАНЕ, 3 KW



№	Характеристики	
69914	300 mm + 2 m маркуч	5

**FESTA**

ГОРЕЛКА ЗА ПОДГРЯВАНЕ



№	Характеристики	
69902	Ø 55 mm, Дължина 550 mm, без маркуч	10

**FESTA**

ГОРЕЛКА ЗА ПОДГРЯВАНЕ



№	Характеристики	
69903	Ø 55 mm, Дължина 550 mm + 3 m маркуч	10

**FESTA**

ГОРЕЛКА ЗА ПОДГРЯВАНЕ



№	Характеристики	
69905	Ø 55 mm, Дължина 900 mm, без маркуч	10

**FESTA**

ГОРЕЛКА ЗА ПОДГРЯВАНЕ



№	Характеристики	
69906	Ø 55 mm, Дължина 900 mm + 3 m маркуч	5



FESTA

ГОРЕЛКА ЗА ПОДГРЯВАНЕ



· Ø 55 mm



№	Характеристики	
69904	60 kW, 850 mm, 5 m маркуч	8

FESTA

ГОРЕЛКА ЗА ПОДГРЯВАНЕ



· Регулатор за налягане от 10 до 33 kg бутилка



№	Характеристики	
69917	Ø 60 mm, Дължина 900 mm + 3 m маркуч 3 m	1

FESTA

МАРКУЧ ЗА ГОРЕЛКИ ЗА ПОДГРЯВАНЕ



№	Характеристики	
69910	3 m с краища	20
69911	5 m с краища	12
69912	10 m с краища	8



РЕГУЛАТОР ЗА НАЛЯГАНЕ ЗА ПРОПАН БУТАН

Входно налягане	25 bar
Налягане на изхода	0,5 - 4,0 bar
Дебит, номинален	16 kg h
Връзка на входа	W 21,8 x 1 14" LH
Връзка на изхода	G3 8" LH



№	Характеристики	
69907		1

РЕДУЦИР ВЕНТИЛ ЗА ПРОПАН БУТАН

Налягане на изхода	4,0 bar
Дебит, номинален	16 kg h
Връзка на входа	W 21,8 x 1 14" LH
Връзка на изхода	G3 8" LH

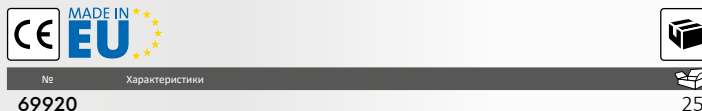

№	Характеристики	
69920		25

РЕДУЦИР ВЕНТИЛ ЗА ПРОПАН БУТАН

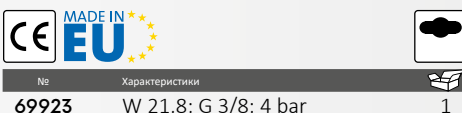

№	Характеристики	
69923	W 21,8; G 3/8; 4 bar	1

РЕГУЛАТОР НА НАЛЯГАНЕТО

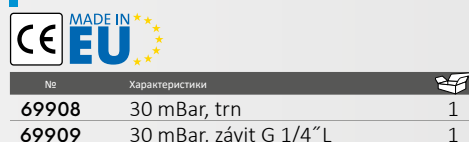

№	Характеристики	
69908	30 mBar, trn	1
69909	30 mBar, závit G 1/4" L	1

ЕДНОПОСОЧЕН КЛАПАН, ВЕНТИЛ

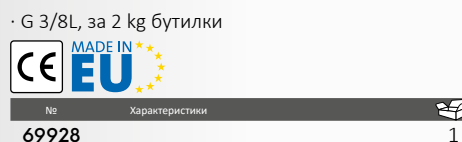

· G 3/8L, за 2 kg бутилки

№	Характеристики	
69928		1

**FESTA****ГАЗОВА ГОРЕЛКА НА ПАТРОН С РЕЗБА**

· макс. температура	1200 °C
· енергия	1,7 kW
· диаметър на горелката	Ø 20 mm



№	Характеристики
69930	piezo

20

**FESTA****ГАЗОВА ГОРЕЛКА НА ПРОБИВНАТА КАСЕТА**

· макс. температура	1200 °C
· енергия	1,7 kW
· диаметър на горелката	Ø 20 mm



№	Характеристики
69931	piezo

12

**КУПА ЗА МАЗИЛКИ**

№	Характеристики
37121	Конусообразна



1

**КУПА ЗА МАЗИЛКИ**

№	Характеристики
37122	Мека гума



1

**КУПА ЗА МАЗИЛКИ, ДВУКОМПОНЕНТНА**

№	Характеристики
33275	Мека и твърда гума



20

**КОФА, ПОЦИНКОВАНА**

Zn	
№	Характеристики
39000	5 l
39001	10 l
39002	12 l
39003	15 l



40

30

20

20

**КОФА С УЛЕЙ**

№	Характеристики
39005	5 l
39010	10 l
39012	12 l
39014	15 l С фуния
39020	20 l
39021	20 l С фуния



1

1

1

1

1

1

**МЕКА КОФА, РУЖИНИРАЦА**

№	Характеристики
39192	30 l
39193	45 l



20

20

ВАНА, КРЪГЛА

№	Характеристики
39045	45 l Ø 54 x 27 cm
39065	60 l Ø 60 x 35 cm
39090	90 l Ø 66 x 35 cm



1

1

1

**ВАНА, ПРАВОЪГЪЛНА**

№	Характеристики
39145	40 l 71 x 40 x 21 cm
39165	65 l 71 x 40 x 30 cm
39190	85 l 77 x 48 x 30 cm



1

1

1



FESTA

• удароустойчива дръжка
найлон + фибростъкло



• Въртяща се на 360° глава

• 3 позиции на превключване
отскок



• смяна на дозата
9:1 / 18:1



FESTA

ПИСТОЛЕТ ЗА УПЛЪТНИТЕЛИ
С КОМПЕНСИРАНЕ
НА ОТСКОКА

№ I No. Характеристики | Specification

38027



1

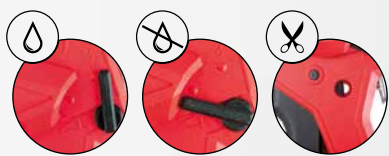

NEW

FESTA

ПИСТОЛЕТ ЗА
УПЛЪТНИТЕЛИ
С КОМПЕНСИРАНЕ
НА ОТСКОКА

С.р. Спецификасе

38032

nylonová



24



FESTA

ПИСТОЛЕТ ЗА
УПЛЪТНИТЕЛИ
С КОМПЕНСИРАНЕ
НА ОТСКОКА



№ I No. Характеристики | Specification

38028



1

FESTA

ПИСТОЛЕТ ЗА
УПЛЪТНИТЕЛИ,
HEAVY DUTY



№ Характеристики

38013



12

FESTA

ПИСТОЛЕТ ЗА
УПЛЪТНИТЕЛИ



№ Характеристики

38001



24

FESTA

ПИСТОЛЕТ ЗА
УПЛЪТНИТЕЛИ



№ Характеристики

38012



6

FESTA

ПИСТОЛЕТ ЗА
УПЛЪТНИТЕЛИ



№ Характеристики

38024



1

ПИСТОЛЕТ ЗА
УПЛЪТНИТЕЛИ
С КОМПЕНСИРАНЕ
НА ОТСКОКА



№	Характеристики	
38010	6ti Шестостен	24

ПИСТОЛЕТ ЗА
УПЛЪТНИТЕЛИ



№	Характеристики	
38025		24

FESTA

ПИСТОЛЕТ ЗА
ХИМИЧЕСКИ
АНКЕР,
380 ML



№	Характеристики	
38020		12

ПИСТОЛЕТ ЗА
УПЛЪТНИТЕЛИ,
СТЕПЕР



№	Характеристики	
38006		12

ПИСТОЛЕТ ЗА
УПЛЪТНИТЕЛИ



№	Характеристики	
38002	6ti hran	24

ПИСТОЛЕТ ЗА
УПЛЪТНИТЕЛИ,
ПЛАСТМАСОВ



№	Характеристики	
38003	6ti hran	24

ПИСТОЛЕТ ЗА
УПЛЪТНИТЕЛИ



№	Характеристики	
38007		24

ПИСТОЛЕТ ЗА
УПЛЪТНИТЕЛИ,
ПОЛУЗАТВОРЕН



№	Характеристики	
38008		24

ПИСТОЛЕТ ЗА
УПЛЪТНИТЕЛИ
СЪС ЗЪБИ



№	Характеристики	
38009		24

ПИСТОЛЕТ ЗА
УПЛЪТНИТЕЛИ



№	Характеристики	
38000		24

FESTA

ПИСТОЛЕТ ЗА
ПОЛИУРЕТАНОВ
УПЛЪТНИТЕЛ



ALU

№	Характеристики	Иконка
38005	310 ml	20
38014	накрайника 3 бр.	100

FESTA

ПИСТОЛЕТ ЗА
ПОЛИУРЕТАНОВ
УПЛЪТНИТЕЛ



ALU

№	Характеристики	Иконка
38004	600 ml	12
38014	накрайника 3 бр.	100

FESTA

ПИСТОЛЕТ ЗА
ПОЛИУРЕТАНОВА ПЯНА
С ТЕФЛОНОВО
ПОКРИТИЕ



TEFLON

№	Характеристики	Иконка
38018		20

FESTA

ПИСТОЛЕТ ЗА
ПОЛИУРЕТАНОВА ПЯНА
С ТЕФЛОНОВО
ПОКРИТИЕ



TEFLON

№	Характеристики	Иконка
38017		20

FESTA

ПИСТОЛЕТ ЗА
ПОЛИУРЕТАНОВА
ПЯНА



TEFLON

TEFLON

№	Характеристики	Иконка
38016		20

FESTA

ПИСТОЛЕТ ЗА
ПОЛИУРЕТА-
НОВА ПЯНА



TEFLON

TEFLON

№	Характеристики	Иконка
38015		20

ПИСТОЛЕТ ЗА
ПОЛИУРЕТА-
НОВА ПЯНА



38031

№	Характеристики	Иконка
38031		20

FESTA

ПИСТОЛЕТ ЗА
ПОЛИУРЕТАНОВА
ПЯНА, ABS



38022

№	Характеристики	Иконка
38022	ABS	20

ПИСТОЛЕТ ЗА
ПОЛИУРЕТА-
НОВА ПЯНА



38021

№	Характеристики	Иконка
38021		24

РЕЗЕРВНА ДЮЗА
С ТЕФЛОНОВО ПОКРИТИЕ

· За пистолети 38015, 38016, 38017, 38018



TEFLON

38030

№	Характеристики	Иконка
38030		5



БОЯДЖИЙСКА ЧЕТКА, ПЛОСКА

№	Широчина	Дебелина	Дължина	
52212	20 mm	15 mm	40 mm	12
52213	30 mm	15 mm	45 mm	12
52214	40 mm	15 mm	45 mm	12
52215	50 mm	15 mm	50 mm	12
52216	60 mm	15 mm	60 mm	12
52217	70 mm	15 mm	65 mm	12
52218	80 mm	15 mm	65 mm	12
52220	100 mm	15 mm	70 mm	12



БОЯДЖИЙСКА ЧЕТКА, ПЛОСКА

№	Широчина	Дебелина	Дължина	
52202	20 mm	12,5 mm	38 mm	12
52203	30 mm	13 mm	38 mm	12
52204	40 mm	14 mm	44 mm	12
52205	50 mm	16 mm	44 mm	12
52206	60 mm	17 mm	52 mm	12
52208	80 mm	17 mm	52 mm	12
52207	100 mm	18 mm	52 mm	12

БОЯДЖИЙСКА ЧЕТКА
ЗА ЪГЛИ

№	Широчина	Дебелина	Дължина	
52283	25 mm	10 mm	44 mm	12
52284	38 mm	10 mm	44 mm	12
52285	50 mm	10 mm	44 mm	12
52286	62 mm	10 mm	50 mm	12
52288	76 mm	10 mm	50 mm	12

КОМПЛ. БОЯДЖИЙСКИ ЧЕТКИ
С ПЛАСТМАСОВА ДРЪЖКА

3x

№	Характеристики	
52070	20, 30, 50 mm	50

КРЪГЛА БОЯДЖИЙСКА
ЧЕТКА PROFİ

№	Характеристики	
52075	Ø 90 mm	10

ЧЕТКА БАДАНАРКА,
ПРАВОЪГЪЛНА, PROFİ

№	Широчина	Дължина	
52076	170 mm	80 mm	10

КОМПЛ. БОЯДЖИЙСКИ ЧЕТКИ
С ПЛАСТМАСОВА ДРЪЖКА

5x

№	Характеристики	
52071	15 mm, 25 mm, 40 mm, 60 mm, 80 mm	50

ЧЕТКА БАДАНАРКА,
КРЪГЛА, СЪС СНОПОВЕ

№	Широчина	Дължина	
52077	Ø 105 mm	70 mm	12

ЧЕТКА БАДАНАРКА,
ПРАВОЪГЪЛНА, СЪС СНОПОВЕ

№	Широчина	Дължина	
52078	170 mm	70 mm	12

ПРИЛОЖЕНИЕ НА ВАЛЯЦИТЕ		ТИП БОИ ИЛИ ПОКРИТИЯ												
		ДИТЕРОЮНИ	АНТИКОРЗИОНИ	СМОЛИ	МАСЛА	ВОДОУПЪЛЪТЯВАЩИ	ПОЛИМЕРНА СМОЛА	УПЪЛЪТЯТЕЛИ	ЛАЗУРНА БОЯ	ЛАТЕКС	ЕПОКСИДНА СМОЛА	2-КОМПОНЕНТНИ	ПЛЪТНИ РАЗТВОРИ	АКРИЛНИ
МАТЕРИАЛ	ДЕБЕЛИНА НА ВЛАКНАТА /mm													
PES	20	•						•		•			•	
PES	20	•	•			•		•		•				•
PAC	18	•						•		•				
PAC	12, 13	•								•				
PAD	18, 21	•								•				
PAD	13	•	•							•				
АГНЕСКА КОЖА	23	•												
НАЙЛОН	13		•	•	•	•	•			•	•	•		
ВЕЛУР	4		•	•			•			•	•	•		
МИКРОФИБЪР	10					•			•	•				
ДУНАПРЕН				•		•								•

ВАЛЯК ЗА БОЯДИСВАНЕ, ПОЛИАКРИЛ

PAC

MADE IN EU

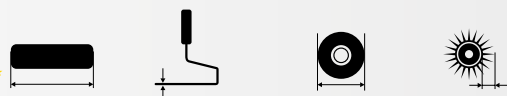

№					
52331	100 mm	∅ 6 mm	∅ 17 mm	12 mm	50
52334	250 mm	∅ 8 mm	∅ 48 mm	12 mm	10



ВАЛЯК ЗА БОЯДИСВАНЕ, ПОЛИАКРИЛ

PAC

MADE IN EU



№					
52391	polster 5 250 mm	∅ 8 mm	∅ 54 mm	18 mm	10



ВАЛЯК ЗА БОЯДИСВАНЕ, ПОЛИАКРИЛ

PAC

MADE IN EU



№					
52328	polster 5 250 mm	∅ 8 mm	∅ 54 mm	18 mm	10
52456	polster 7 250 mm	∅ 8 mm	∅ 67 mm	18 mm	10



ВАЛЯК ЗА БОЯДИСВАНЕ, ПОЛИАМИД

PAD

MADE IN EU

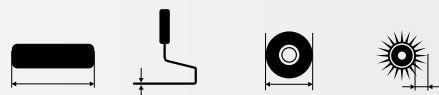

№					
52428	polster 7 250 mm	∅ 8 mm	∅ 67 mm	18 mm	10



ВАЛЯК ЗА ЛАЗУРНА БОЯ, НАЙЛОН

PAD

MADE IN EU



№					
52421	100 mm	∅ 6 mm	∅ 17 mm	13 mm	50
52424	250 mm	∅ 8 mm	∅ 48 mm	13 mm	10



ВАЛЯК ЗА БОЯДИСВАНЕ, ПОЛИЕСТЕР

PES

MADE IN EU



№					
52305	180 mm	∅ 6 mm	∅ 42 mm	20 mm	10
52306	250 mm	∅ 6 mm	∅ 42 mm	20 mm	10



ВАЛЯК ЗА НАНАСЯНЕ НА ЛАКОВЕ И ПОКРИТИЯ, ДУНАПРЕН

MADE IN EU

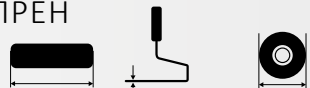

№				
52471	rovny 100 mm	∅ 6 mm	∅ 35 mm	50



БОЯДЖИЙСКИ КОМПЛЕКТ

PAC

MADE IN EU



№	Характеристики	Обем
52600	polster 4 180 mm Ø 8 mm Ø 53 mm 18 mm	1

БОЯДЖИЙСКИ КОМПЛЕКТ, ВЕСТАН

PES

MADE IN EU



№	Характеристики	Обем
52610	180 mm Ø 6 mm Ø 42 mm 20 mm	25
52605	250 mm Ø 6 mm Ø 42 mm 20 mm	20

БОЯДЖИЙСКИ КОМПЛЕКТ

- 1x Валяк PAD 13 mm / 10 cm
- 1x Валяк PAC 12 mm / 10 cm
- 1x Валяк PES 11 cm
- Дръжка + Ваничка

MADE IN EU



№	Обем
52602	10

ВАЛЯК ЗА БОЯДИСВАНЕ, ПОЛИАКРИЛ, ЪГЛОВ

PAC

MADE IN EU

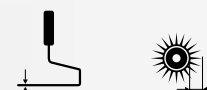

№	Характеристики	Обем
52601	дръжка Ø 6 mm 18 mm	1

ВАНИЧКА ЗА БОЯ

MADE IN EU



№	Характеристики	Обем
52662	150 x 270 mm 100 mm	1
52666	260 x 290 mm 180 mm	1
52671	330 x 340 mm 250 mm	1

КОФА ЗА БОЯ

MADE IN EU



№	Характеристики	Обем
52694	8 l	25
52695	12 l	20

РЕШЕТКА ЗА БОЯ

MADE IN EU



№	Характеристики	Обем
52652	230 mm 250 mm	100
52656	270 mm 290 mm	100



ДРЪЖКА ЗА ВАЛЯК

MADE IN EU



ДРЪЖКА ЗА ВАЛЯК



№	Характеристики	Обем
52640	5 cm Ø 6 mm	100
52645	8,5 cm Ø 6 mm x 27 mm	100

MADE IN EU

№	Характеристики	Обем
52630	18 cm Ø 6 mm	100
52635	25 cm Ø 6 mm	100
52620	18 cm Ø 8 mm	50
52625	25 cm Ø 8 mm	50

СТЪРГАЛКА ЗА БОЯ И ЛАК

№	Обем
37005	12



FESTA

ТЕЛЕСКОПИЧНА ДРЪЖКА

· резба за 31610, 34203

№	Характеристики	
52011	88 - 140 cm	1



ТЕЛЕСКОПИЧНА ДРЪЖКА

ALU

№	Дължина		
52010	120 cm	ALU	50
52012	240 cm	ALU	25



ТЕЛЕСКОПИЧНА ДРЪЖКА

№	Дължина		
52020	300 cm	Стомана	10



ТЕЛЕСКОПИЧНА ДРЪЖКА

№	Дължина		
52030	240 cm	Фибростъкло	6



САМОЗАЛЕПВАЩО ПОКРИТИЕ С ЛЕНТА

№	Широчина	Дължина	
37243	55 cm	30 m	60
37244	110 cm	30 m	30
37245	140 cm	30 m	30
37246	180 cm	15 m	30
37290	210 cm	20 m	30
37247	240 cm	15 m	30
37291	270 cm	16 m	30



ЗАЩИТНИ ГАЩЕРИЗОНИ

№	Характеристики	
50585	размер M	1
50586	размер L	1
50587	размер XL	1
50588	размер XXL	1



ЗАЩИТНО ФОЛИО ЗА ВРАТИ С ЦИП

№	Характеристики	
37248	1,2 x 2,2 m 100 µm	Маскираща лента 45 mm x 25 m 25



ЗАЩИТНО ФОЛИО

№	objem	Дебелина материала	
37250	4 x 5 m	0,007 mm	100
37251	4 x 12,5 m	0,007 mm	50
37252	2 x 50 m	0,007 role	20



ЗАЩИТНО ФОЛИО

№	Характеристики	Дебелина материала	
37253	4 x 5 m	0,03 mm	100

ЗАЩИТНО ПОКРИТИЕ ОТ ГОФРИРАН КАРТОН



№	Широчина	Дължина	
54008	1 m	10 m	1

FESTA



**РЕ БРЕЗЕНТ,
КЛАС
PROFI**

· Син, сребрист

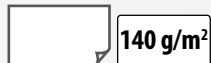

№	Характеристики	
25206	2 x 3 m	25
25212	3 x 4 m	10
25215	3 x 5 m	8
25220	4 x 5 m	8
25224	4 x 6 m	8
25230	5 x 6 m	8

№	Характеристики	
25240	5 x 8 m	4
25248	6 x 8 m	3
25260	6 x 10 m	3
25296	8 x 12 m	2
25350	10 x 15 m	1



**БРЕЗЕНТ,
КЛАС
ECONOMIC**

· Син



№	Характеристики	
25369	2 x 2 m	50
25370	2 x 3 m	20
25371	3 x 4 m	10
25372	3 x 5 m	10
25373	4 x 5 m	10

№	Характеристики	
25374	4 x 6 m	5
25376	5 x 8 m	5
25378	6 x 10 m	2
25379	8 x 12 m	2
25380	10 x 15 m	2

**БРЕЗЕНТ,
КЛАС
STANDARD**

· Син, сребрист



№	Характеристики	
25155	2 x 2 m	50
25006	2 x 3 m	50
25009	3 x 3 m	35
25012	3 x 4 m	20
25015	3 x 5 m	10
25016	4 x 4 m	10
25020	4 x 5 m	10
25024	4 x 6 m	10

№	Характеристики	
25025	5 x 5 m	10
25030	5 x 6 m	10
25040	5 x 8 m	5
25048	6 x 8 m	5
25060	6 x 10 m	5
25096	8 x 12 m	2
25150	10 x 15 m	2
25153	15 x 20 m	1

**БРЕЗЕНТ,
КЛАС
STANDARD**

· Зелен

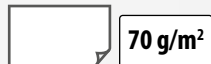

№	Характеристики	
25179	2 x 2 m	50
25180	2 x 3 m	50
25195	2 x 8 m	20
25181	3 x 4 m	20
25182	3 x 5 m	10
25183	4 x 5 m	10

№	Характеристики	
25184	4 x 6 m	10
25186	5 x 8 m	5
25188	6 x 10 m	5
25189	8 x 12 m	2
25190	10 x 15 m	2

**РЕ БРЕЗЕНТ,
КЛАС
PROFI**

· Зелен

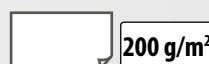

№	Характеристики	
25160	2 x 3 m	15
25171	2 x 8 m	1
25162	3 x 5 m	5
25163	4 x 5 m	4

№	Характеристики	
25164	4 x 6 m	3
25167	6 x 8 m	2
25169	8 x 12 m	1
25170	10 x 15 m	1

**РЕ БРЕЗЕНТ,
КРЪГЪЛ**

· Син, сребрист



№	Характеристики	
25003	∅ 3,6 m	15
25004	∅ 4,5 m	5
25005	∅ 5,5 m	4
25002	∅ 6,5 m	3



**ОБТЕГАЧ
ЗА БРЕЗЕНТ**

4x

№	Характеристики	
25400	20 cm	1

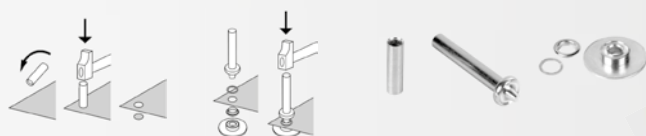

АПЛИКАТОР ЗА КАПСИ ЗА РЕ БРЕЗЕНТИ

№	Характеристики	
25410	Апликатор + 25 ок капси	1



**КАПСИ ЗА
РЕ БРЕЗЕНТИ**

10x

№	Характеристики	
25001		1





ТЕЛЕСКОПИЧНА СГЪВАЕМА СТЪЛБА

· max. 150 kg



№	Характеристики		
48415	1,9 / 3,8 m	6/12 дяла	1

ТЕЛЕСКОПИЧНА СТЪЛБА

· max. 150 kg



№	Характеристики		
48410	3,2 m	11 дяла	1
48411	3,8 m	13 дяла	1

СГЪВАЕМА РАБОТНА ПЛАТФОРМА

· max. 150 kg



№	Характеристики		
48420			1



NEW

2.75m		H	L	H	L	1.73m	
		1.60m	1.14m	1.69m	1.32m	0.93m	0.99m

РАБОТНА ПЛАТФОРМА



· max 150 kg

№	Характеристики		
37660			1





РЕГУЛИРУЕМА СТОЙКА ЗА РЯЗАНЕ



№	Характеристики	
37545	140 cm, Височина 98- 165 cm	1
37546	120 cm, Височина 98- 165 cm	1

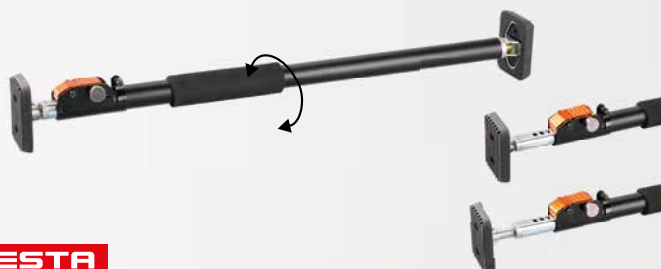

FESTA

ПОДПОРЕН КРИК ЗА ВРАТИ, ДОГРАМА И ДР.

· max. 40 kg

№	Характеристики		
52060	66- 115 cm	1	
52065	160- 290 cm	1	



ПОДПОРЕН КРИК ЗА ВРАТИ, ДОГРАМА И ДР.

№	Характеристики		
52050	50- 115 cm	1	
52055	115- 290 cm	1	



ТЕЛЕСКОПИЧНА ПОДПОРА ЗА КОФРАЖ

· 48449 Клетка за подпори



№	Характеристики	
48452	160- 290 cm	1
48453	180- 320 cm	1
48454	200- 360 cm	1
48455	250- 440 cm	1
48456	260- 380 cm	1
48457	220- 400 cm	1

NEW

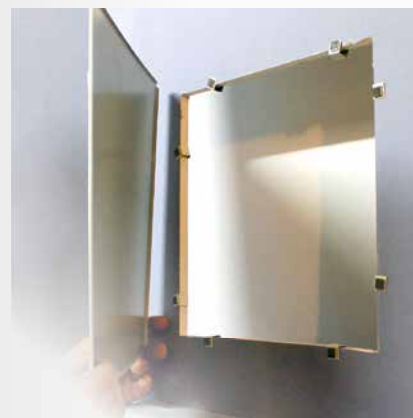

РЕВИЗНА ВРАТИЧКА, МАГНИТНА

	№	Характеристики	
	82100	10 - 21 cm	1
	82101	20 - 31 cm	1
	82102	30 - 41 cm	1
	82103	40 - 51 cm	1
	82104	50 - 58 cm	1



ВРАТИЧКА ЗА КОМИН



№	Характеристики	
65062		1



ВРАТИЧКА ЗА КОМИН КОМАХ



№	Характеристики	
65063	сива	1
65064	бяла	1



ВРАТИЧКА ЗА КОМИН, ГАЛВАНИЗИРАНА



№	Характеристики	
65065		1

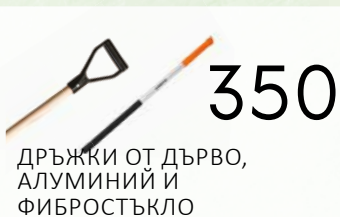
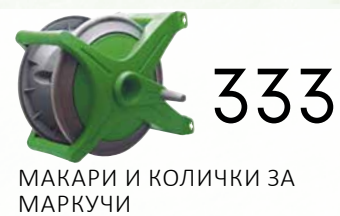



ГРАДИНСКИ ИНСТРУМЕНТИ
И ОГРАДИ

308 - 359





WINLAND®

ГРАДИНСКИ
НОЖИЦИ

№	Размери
45020	205 mm
44980	Резервна пружина



10

1



WINLAND®

ГРАДИНСКИ
НОЖИЦИ

№	Размери
45023	205 mm
44980	Резервна пружина



10

1



WINLAND®

ГРАДИНСКИ
НОЖИЦИ

№	Размери
45063	215 mm
44981	Резервна пружина



10

1



WINLAND®

ГРАДИНСКИ
НОЖИЦИ

№	Размери
44972	215 mm
44981	Резервна пружина



10

1

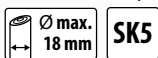

WINLAND®

ГРАДИНСКИ
НОЖИЦИ

№	Размери
45099	190 mm
44983	Резервна пружина



10

1

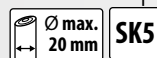

WINLAND®

ГРАДИНСКИ
НОЖИЦИ

№	Размери
45098	220 mm
44983	Резервна пружина



10

1



WINLAND®



WINLAND®

ГРАДИНСКИ
НОЖИЦИ
С ТРЕСЧОТКА

№	Размери
45095	200 mm
44982	Резервна пружина



10

1

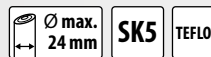

WINLAND®

ГРАДИНСКИ
НОЖИЦИ

№	Размери
45096	220 mm
44982	Резервна пружина



· Въртяща дръжка



6

1



ГРАДИНСКИ НОЖИЦИ,
НЕРЪЖДАЕМА
СТОМАНА

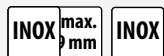

№	Размери	
45089	160 mm	10



ГРАДИНСКИ
НОЖИЦИ



№	Размери	
45097	210 mm	10
44981	Резервна пружина	1



ГРАДИНСКИ НОЖИЦИ,
НЕРЪЖДАЕМА
СТОМАНА

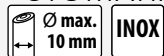

№	Размери	
45088	160 mm	10

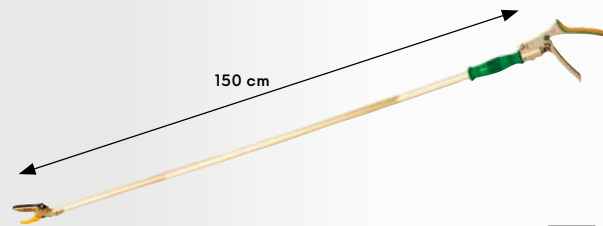

НОЖИЦА ЗА РЪЗАНЕ НА ВИСОКИ КЛОНИ

№	Размери	
45017		10



РЕЗЕРВНИ ПРУЖИНИ



№	За ножици	
44981	45021, 45025, 45063, 45097	1
44980	45020, 45023	1
44983	45098, 45099	1
44982	45027, 45095, 45096	1
44984	45110, 45014, 45026	1
44985	45018	1



РЕЗЕРВНО ОСТРИЕ
С ТЕФЛОНОВО
ПОКРИТИЕ

· За ножици 45095, 45027



№	Размери	
45094		20



НОЖИЦА
ЗА КЛОНИ



№	Размери	
44991	76 cm	12



НОЖИЦА ЗА КЛОНИ,
ТЕЛЕСКОПИЧНА



№	Размери	
44992	70 - 103 cm	10



НОЖИЦА ЗА ЖИВ ПЛЕТ



№	Размери	
44996	61 cm, Вълнообразно острие	12



НОЖИЦИ ЗА ЖИВ ПЛЕТ



№	Размери	
44997	61 cm, rovné ostří	12



НОЖИЦИ ЗА ТРЕВА, ВЪРТЯЩА НА 360°



№	Размери	
44998		6



ТОЧИЛО ЗА НОЖИЦИ И НОЖОВЕ, 6 В 1



№	Размери	
45068		10



ТОЧИЛО ЗА НОЖИЦИ И НОЖОВЕ



№	Размери	
45048		20

FESTA

ГРАДИНСКИ НОЖИЦИ

· Пластмасова дръжка



№	Размери	
45021	210 mm	6

ГРАДИНСКИ НОЖИЦИ



№	Размери	
45019	210 mm	10



FESTA

НОЖИЦИ



№	Размери	
45010	190 mm	12
44984	Резервна пружина	1

НОЖИЦИ

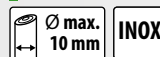

№	Размери	
45014	190 mm	12
44984	Резервна пружина	1

НОЖИЦИ



№	Размери	
45026	150 mm	12
44985	Резервна пружина	1

ГРАДИНСКИ НОЖИЦИ

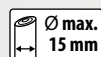

№	Размери	
45018	210 mm ковани	10

ГРАДИНСКИ НОЖИЦИ,
АЛУМИНИЙ

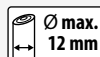

ALU



№	Размери
45025	200 mm



ГРАДИНСКИ
НОЖИЦИ



INOX



№	Размери
44970	210 mm



ГРАДИНСКИ
НОЖИЦИ
С ТРЕСЧОТКА

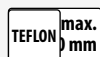

TEFLON



№	Размери
45027	200 mm



ГРАДИНСКИ
НОЖИЦИ



INOX

ALU



№	Размери
45029	200 mm



ГРАДИНСКИ
НОЖИЦИ

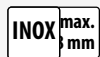

INOX



№	Размери
44971	160 mm



ГРАДИНСКИ
НОЖИЦИ



INOX



№	Размери
45016	180 mm



ГРАДИНСКИ
НОЖИЦИ

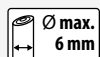

INOX



№	Размери
45015	190 mm, Прави



КАЛЪФ
ЗА ГРАДИНСКИ НОЖИЦИ



№	Размери
37317	



НОЖИЦИ
ЗА ТРЕВА



TEFLON



№	Размери
45011	300 mm



НОЖИЦИ
ЗА ТРЕВА



№	Размери
45012	370 mm, С въртене до 180°



НОЖИЦИ
ЗА КЛОНИ



TEFLON

NYLON



№	Размери
44999	540 mm, Обли



FESTAНОЖИЦИ
ЗА КЛОНИ

№	Размери	Кол-во
45000	750 mm, Обли	6

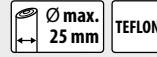
FESTAНОЖИЦИ
ЗА КЛОНИ

№	Размери	Кол-во
45001	710 mm, Обли	6

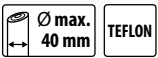
FESTAНОЖИЦИ
ЗА КЛОНИ
С ТРЕСЧОТКА

№	Размери	Кол-во
45002	750 mm, С тресчотка	12

НОЖИЦИ
ЗА КЛОНИ,
ТЕЛЕСКОПИЧНИ

№	Размери	Кол-во
45003	660-900 mm, телескопична	6

FESTA

НОЖИЦИ ЗА ХРАСТИ

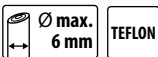

№	Размери	Кол-во
45005	580 230 mm, Вълнообразно острие	6

FESTA

НОЖИЦИ ЗА ХРАСТИ



№	Размери	Кол-во
45006	580 230 mm, Право острие	6

FESTAНОЖИЦИ ЗА ХРАСТИ,
ТЕЛЕСКОПИЧНИ

№	Размери	Кол-во
45007	670-870 230 mm, Вълнообразно острие	6

НОЖИЦИ ЗА ХРАСТИ



№	Размери	Кол-во
44995	440 160 mm	12

ГРАДИНСКИ НОЖИЦИ



№	Размери	Кол-во
45009	500 190 mm, Вълнообразно острие	6

ГРАДИНСКИ НОЖИЦИ



№	Размери	Кол-во
45008	500 190 mm, Право острие	6

СЪРП



№	Размери	Кол-во
45490	450 mm	1



FESTA

МАЧЕТЕ



TEFLON

№	Размери	Колони
45069	440 mm	6

FESTA

МАЧЕТЕ И ТРИОН



TEFLON

№	Размери	Колони
44950	490 mm	4

МАЧЕТЕ,
НЕРЪЖДАЕМА
СТОМАНА

INOX

№	Размери	Колони
45083	430 mm	12
45084	600 mm	6



МАЧЕТЕ

· Дървена ръкохватка (ясен)

№	Размери	Колони
45081	510 mm	36
45082	710 mm	36



FESTA

СГЪВАЕМ ТРИОН

По 3 закалени и заточени зъби

№	Характеристики	Колони
45061	150 mm с предпазител за ръката	12



FESTA

СГЪВАЕМ ТРИОН

По 3 закалени и заточени зъби

№	Характеристики	Колони
45060	180 mm	6



FESTA

СГЪВАЕМ ТРИОН С КАНИЯ

По 3 закалени и заточени зъби

№	Характеристики	Колони
45062	260 mm с каня	24



FESTA

ГРАДИНСКИ ТРИОН

По 3 закалени и заточени зъби

№	Характеристики	Колони
24152	350 mm 7 tpi	12



FESTA

ТЕЛЕСКОПИЧЕН ТРИОН С КАНИЯ

По 3 закалени и заточени зъби

№	Характеристики	Колони
45033	230 - 490 mm	1



НОЖИЦА С ТРИОН
С ТЕЛЕСКОПИЧНА
ДРЪЖКА

№	Характеристики	Колони	
45030	пилка 30 cm	Телескопична дръжка 240 cm	6
45031	пилка 30 cm		6



НОЖИЦА С ТРИОН

№	Характеристики	Колони
45032	Метална решетка без трион	6





FESTA

FESTA

БРАДВА

DIN 5131 **DIN 7294**

- Дървена дръжка, ясен
- Заоблено чело



№	Характеристики		№	Характеристики	
19380	600 g	1	19384	1400 g	1
19381	800 g	1	19385	1600 g	1
19382	1000 g	1	19387	2000 g	1
19383	1250 g	1			

FESTA

ДЪРВОДЕЛСКА БРАДВА

- Дървена дръжка, ясен



№	Характеристики	
19340	700 g	22

FESTA

БРАДВА-ЧУК

- Дървена дръжка, ясен
- Заоблено чело

DIN 5129	№	Характеристики	
	19389	3000 g	1
	19388	4000 g	1



FESTA

БРАДВА

- Дървена дръжка, ясен
- Заоблено чело

DIN 7294	№	Характеристики	
	19391	2000 g	1



FESTA

БРАДВА

- Фибростъкло

С.р.	специфика	
19326	600 g	6
19328	800 g	24
19330	1000 g	12
19332	1250 g	8
19333	1500 g	6
19335	1600 g	6
19337	2000 g	6



FESTA

РАЗЦЕПВАЩА БРАДВА

- Фибростъкло

С.р.	специфика	
19392	1000 g	6



FESTA

БРАДВА

- Фибростъкло

С.р.	специфика	
19301	500 g	6



FESTA

РАЗЦЕПВАЩА БРАДВА

- Фибростъкло

№	Характеристики	
19390	2000 g	6





FESTA

БРАДВА-ЧУК

· Фибростъкло

№	Характеристики	
19370	3000 g	4
19371	4000 g	4



ДЪРВЕН САП ЗА БРАДВА



С.р.	specifikace	pro sekeru	
61340	36 cm	19380	10
61341	40 cm	19381, 19340	10
61342	50 cm	19382	10
61343	70 cm	19383, 19384	10
61344	80 cm	19385, 19391	10
61345	90 cm	19387	10
61346	90 cm	19388, 19389	10

БРАДВА

С.р.	specifikace	
19306	600 g	24
19308	800 g	24
19310	1000 g	24
19312	1250 g	12
19314	1500 g	12



КЛИН ЗА ЦЕПЕНЕ, МЕТАЛЕН

№	Характеристики	
19397	2000 g 55 x 210 x 45 mm	10
19465	2500 g 65 x 230 x 45 mm	10



КЛИНОВЕ ЗА ЦЕПЕНЕ, ТВЪРДА ПЛАСТМАСА



№	Характеристики	
19462	175 x 65 x 20 mm	1
19463	230 x 70 x 30 mm	1
19464	240 x 75 x 40 mm	1



КЛИН ЗА ЦЕПЕНЕ, МЕТАЛЕН

№	Характеристики	
19394	1000 g 35 x 180 x 40 mm	6
19395	2000 g 40 x 255 x 55 mm	6
19396	2500 g 40 x 260 x 55 mm	8



РАЗЦЕПВАЩ ДОРНИК SDS+

SDS+

№	Характеристики	
19393	Ø 32 x 132 mm	10
19374	Ø 42 x 145 mm	10



КЛИН ЗА ЦЕПЕНЕ, МЕТАЛЕН

№	Характеристики	
19469	2500 g 165 x 87 mm	10

ГРАДИНСКА ЛОПАТКА, ШИРОКА

INOX



№	Размери	
45056	360 mm	12

ГРАДИНСКА ЛОПАТКА, ТЯСНА

INOX



№	Размери	
45057	360 mm	12

МОТИЧКА

INOX



№	Размери	
45058	270 mm	12

ВИЛА ЗА ПЛЕВЕНЕ С ЛЮЛКА ЗА ПРЪСТ

INOX



№	Размери	
45059	360 mm	12

ГРАДИНСКА ЛОПАТКА, ШИРОКА

NYLON



№	Размери	
45065	280 mm	1

ГРАДИНСКА ЛОПАТКА, ТЯСНА

NYLON



№	Размери	
45066	310 mm	1

ГРАДИНСКА ВИЛИЦА,

NYLON



№	Размери	
45067	290 mm	1

КОМПЛЕКТ ИНСТРУМЕНТИ

HOBBY

4x



№	Размери	
45035	240 mm	35

МОТИЧКА, ДВУСТРАННА, С ДРЪЖКА

№	Размери	Дължина на дръжката	
61294	140 mm	27 cm	MOQ 3
61221	дръжка	27 cm	1



МОТИЧКА, ДВУСТРАННА, С ДРЪЖКА

№	Размери	Дължина на дръжката	
61295	140 mm	27 cm	MOQ 3
61221	дръжка	27 cm	1



МОТИЧКА С ДРЪЖКА

№	Размери	Дължина на дръжката	
61296	175 mm	27 cm	MOQ 3
61221	дръжка	27 cm	1



МОТИКА С 3 ЗЪБА, С ДРЪЖКА

№	Размери	Дължина на дръжката	
61297		27 cm	MOQ 3
61221	дръжка	27 cm	1





СГЪВАЕМА ЛОПАТА

· Калъф

№	Размери	
61085	410 mm	6



ИНСТРУМЕНТ ЗА САДЕНЕ НА ЛУКОВИЦИ

INOX

№	Размери	
45040	230 mm	60



ШИЛО ЗА САДЕНЕ "Т"

№	Размери	
45038	280 mm	60



НОЖ ЗА ПЛЕВЕЛИ

№	Размери	
45079	200 mm	1



НОЖ ЗА ПЛЕВЕЛИ

№	Размери	
45080	200 mm „L“	1



ПЛОДОБЕРАЧ ЗА МОНТИРАНЕ НА ПРЪТ



№	Размери	
45041		75



ПЛОДОБЕРАЧ ЗА МОНТИРАНЕ НА ПРЪТ

№	Размери	
45039		50
45034	170 - 300 cm, Телескопична дръжка	5



ТРИНОЖНИК ЗА ПЛЕВЕНЕ

№	Размери	
44955	950 mm	16



КУЛТИВАТОР

№	Размери	
45042	160 x 132 cm	12



КУЛТИВАТОР

№	Размери	
44053		12
61251	160 cm дръжка	1



РЪЧНА КОЛИЧКА

Размери	
Височина:	111 cm
Широчина:	55 cm
Обем	12 l

№	Размери	
45085	12 l	1

FESTA

ТОЧИЛО ЗА НОЖИЦИ И НОЖОВЕ 16 В 1



	30° Anvil	
	45° Anvil	
	50° Anvil	
	23° Bypass	
	35° Bypass	
	65° Bypass	
	Deburrr Tool	



№ 45073 Размери

1



ТОЧИЛО ЗА НОЖИЦИ И НОЖОВЕ, 6 В 1

№ 45068 Размери 10



ТОЧИЛО ЗА НОЖИЦИ И НОЖОВЕ

№ 45048 Размери 20



ТОЧИЛО ЗА КОСА

№ 45046 Размери 205 x 15 mm 100



ТОЧИЛО, ОВАЛНО

№ 45370 Размери 250 x 33 x 18 mm 20



ТОЧИЛО, ДВУПЛАСТОВО

№ 45045 Размери 150 x 50 x 30 mm 10



ТОЧИЛО ЗА НОЖИЦИ И НОЖОВЕ

№ 16991 Размери 20



ТОЧИЛО ЗА НОЖИЦИ И НОЖОВЕ

№ 16990 Размери Ø 50 mm 50





КОРДА ЗА ТРИМЕРИ
С НАЙЛОНОВО ПОКРИТИЕ



№	Размери		
45530	2 mm x 15 m	■	1
45531	2,4 mm x 15 m	■	1
45532	3 mm x 15 m	■	1
45533	3,15 mm x 15 m	■	1
45534	4 mm x 15 m	■	1



КОРДА ЗА ТРИМЕРИ

№	Размери		
45520	2 mm x 162 m	●	10
45521	2,4 mm x 112 m	●	10
45528	2,7 mm x 90 m	●	10
45522	3 mm x 72 m	●	10
45525	2 mm x 162 m	★	10
45526	2,4 mm x 112 m	★	10
45529	2,7 mm x 90 m	★	10
45527	3 mm x 72 m	★	10

КОРДА ЗА ТРИМЕРИ

№	Размери		
45500	1,3 mm x 15 m	●	30
45502	1,3 mm x 15 m	★	30
45503	1,6 mm x 15 m	●	20
45505	1,6 mm x 15 m	★	20
45506	2 mm x 15 m	●	12
45508	2 mm x 15 m	★	12
45517	2 mm x 15 m	■	10
45509	2,4 mm x 15 m	●	12
45511	2,4 mm x 15 m	★	12
45512	2,4 mm x 15 m	■	12
45518	2,4 mm x 15 m	■	10
45523	2,7 mm x 15 m	●	10
45524	2,7 mm x 15 m	★	10
45513	3 mm x 15 m	●	10
45515	3 mm x 15 m	★	10
45516	3 mm x 15 m	■	10
45519	3 mm x 15 m	■	10



НЕТЪКАН ТЕКСТИЛ ЗА
МУЛЧИРАНЕ, БЯЛ



17 g/m²

№	Размери		
45540	1,6 x 5 m		40
45541	1,6 x 10 m		40
45542	1,6 x 50 m	в роля	1
45543	1,6 x 100 m	в роля	1

НЕТЪКАН ТЕКСТИЛ ЗА
МУЛЧИРАНЕ



50 g/m²

№	Размери		
45550	1,6 x 5 m		50
45551	1,6 x 10 m		20
45564	3,2 x 10 m		20
45552	1,6 x 50 m	в роля	1
45553	1,6 x 100 m	в роля	1
45562	3,2 x 50 m	в роля	1
45563	3,2 x 100 m	в роля	1

НЕТЪКАН ТЕКСТИЛ ЗА
МУЛЧИРАНЕ



50 g/m²

№	Размери		
45556	1,6 x 5 m		50
45557	1,6 x 10 m		20
45565	3,2 x 10 m		20
45558	1,6 x 50 m	в роля	1
45559	1,6 x 100 m	в роля	1

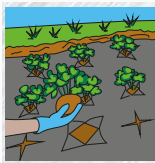

ТЕКСТИЛ ЗА МУЛЧИРАНЕ С ОТВОРИ ЗА РАСТЕНИЯ

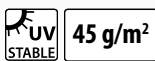

№	Размери	Короб
45535	1,6 x 5 m	18



КОЛЧЕ КОТВА ЗА ТЕКСТИЛ ЗА МУЛЧИРАНЕ



№	Размери	Короб
45555	11,5 cm	1

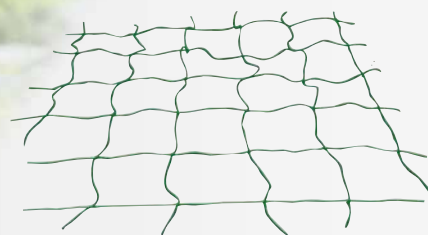
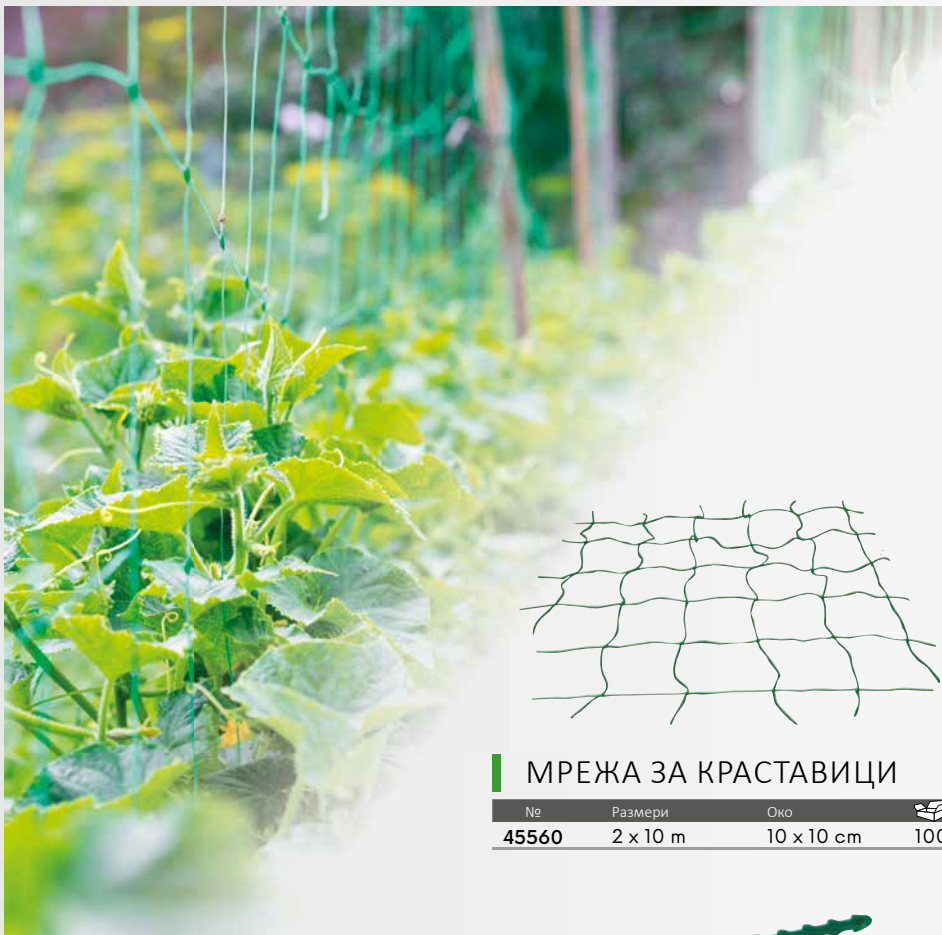

МРЕЖА ЗА КРАСТАВИЦИ

№	Размери	Око	Короб
45560	2 x 10 m	10 x 10 cm	100



ГРАДИНСКИ КОЛЧЕТА, ФИБРОСТЪКЛО

№	Размери	Короб
45036	180 cm Ø 7,9 mm	100

СТЯЖКИ, НАЗЪБЕНИ, 50 БРОЯ

№	Размери	Короб
23840		20



ГРАДИНСКИ КОЛЧЕТА, СЪТЪКЛОПЛАСТ

№	Размери	Короб	№	Размери	Короб	№	Размери	Короб
45650	90 cm Ø 8 mm	25	45655	150 cm Ø 11 mm	25	45659	180 cm Ø 16 mm	25
45651	120 cm Ø 8 mm	25	45656	180 cm Ø 11 mm	25	45660	210 cm Ø 16 mm	25
45652	150 cm Ø 8 mm	25	45661	210 cm Ø 11 mm	25	45662	150 cm Ø 20 mm	10
45653	90 cm Ø 11 mm	25	45657	120 cm Ø 16 mm	25	45663	180 cm Ø 20 mm	10
45654	120 cm Ø 11 mm	25	45658	150 cm Ø 16 mm	25	45664	210 cm Ø 20 mm	10



ГРАДИНСКИ КОЛЧЕТА, СПИРАЛНИ

№	Размери	Материал	Короб
44041	1,2 m, Ø 5,5 mm	Комаксит- зелен	10
44042	1,5 m, Ø 6 mm	Комаксит- зелен	10
44043	1,8 m, Ø 6 mm	Комаксит- зелен	10
45049	1,8 m, Ø 7 mm	Комаксит- зелен	10
45044	1,8 m, Ø 7 mm	Комаксит- сребърен	10
44050	2,2 m, Ø 7 mm	Комаксит- зелен	10



КОНЕКТОР ЗА КОЛЧЕТА, ФИБРОСТЪКЛО

№	Размери	Короб
45670	8 mm	10
45671	11 mm	10
45672	16 mm	10
45673	20 mm	10



ВЕЛКРО ЛЕНТА

№	Размери	Колонки
45471	12 mm x 5 m	1



ТЕЛ ЗА ВРЪЗВАНЕ С PVC ПОКРИТИЕ

№	Размери	Колонки
45043	30 m	30



ТЕЛ ЗА ВРЪЗВАНЕ С ГУМЕНО ПОКРИТИЕ

№	Размери	Колонки
23845	3 mm x 8 m	30
23846	4 mm x 6 m	30
23847	5 mm x 4 m	30



ЛЕНТА ЗА ВРЪЗВАНЕ, 3 БРОЯ

№	Размери	Колонки
45472	3 cm x 3 m, 3 бр	36



ЛЕНТА ЗА ВРЪЗВАНЕ

№	Размери	Колонки
45473	3 cm x 50 m	60



ПОДЛОЖКА ЗА КЛЯКАНЕ

№	Размери	Колонки
45086	40 x 18 x 2 cm	50



ГРАДИНСКО СТОЛЧЕ, СГЪВАЕМО

· За сядане и при заставане на колене

№	Размери	Колонки
45074	58 x 48 x 28 cm	4



СГЪВАЕМ КОШ

№	Размери	Колонки
45093	40 x 25 x 23 cm	10



МЕКА КОФА, ПРУЖИНИРАЩА



№	Размери	Колонки
39192	26 l	20
39193	42 l	20



КОШ ЗА ЛИСТА, СГЪВАЕМ

№	Размери	Колонки
45047	55 x 70 cm, 3 дръжки	20



КОШ ЗА ЛИСТА, СГЪВАЕМ

№	Размери	Колонки
44960	200 l 60 x 60 x 55 cm	50



FESTA[®]
AQUATIC



FESTA[®]
AQUATIC

**ПИСТОЛЕТ
ЗА ПОЛИВАНЕ**

- 7 функции
- Преден спусък с опция за заключване
- Лесно управление на потока



№	Размери	Пакет
45386		12



FESTA[®]
AQUATIC

**ПИСТОЛЕТ
ЗА ПОЛИВАНЕ**

- Различни настройки за поливане
- Преден спусък с опция за заключване
- Лесно управление на потока



№	Размери	Пакет
45388		12



FESTA[®]
AQUATIC

РАЗПРЪСКВАЧ ЗА ПОЛИВАНЕ

- Различни настройки за поливане



№	Размери	Пакет
45389		24



FESTA[®]
AQUATIC

**КОМПЛЕКТ С РАЗПРЪСКВАЧ
ЗА ПОЛИВАНЕ**

- Различни настройки за поливане



№	Размери	Пакет
45385	4 бр	12



FESTA[®]
AQUATIC

КОНЕКТОР ЗА МАРКУЧ



№	Размери	Пакет
45390	1/2"	24



FESTA[®]
AQUATIC

КОНЕКТОР ЗА МАРКУЧ



№	Размери	Пакет
45392	1/2"	24



FESTA[®]
AQUATIC

**КОНЕКТОР СЪС СТОП
КЛАПАН ЗА МАРКУЧ**



№	Размери	Пакет
45394	1/2"	24

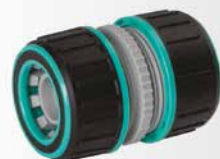

FESTA[®]
AQUATIC

КОНЕКТОР ЗА МАРКУЧ



№	Размери	Пакет
45391	3/4"	24



FESTA[®]
AQUATIC

КОНЕКТОР ЗА МАРКУЧ



№	Размери	Пакет
45393	3/4"	24



FESTA[®]
AQUATIC

**КОНЕКТОР СЪС СТОП
КЛАПАН ЗА МАРКУЧ**



№	Размери	Пакет
45395	3/4"	24

FESTA
AQUATIC

АДАПТЕР



№	Размери	Пакет
45396		24



NEW



FESTA
AQUATIC

ГРАДИНСКИ МАРКУЧ,
ПРОФИ



№	Размери	Пакет
45372	1/2" 25 m	1
45373	1/2" 50 m	1
45374	3/4" 25 m	1
45375	3/4" 50 m	1
45376	1" 25 m	1
45377	1" 50 m	1



FESTA
AQUATIC

РАЗПРЪСКВАЧ, ВЪРТАЩ

· 19 накрайника, 8 от които с опция за включване/изключване



№	Размери	Пакет
45398		6

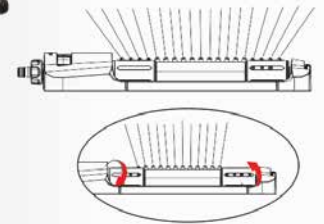

FESTA
AQUATIC

РАЗПРЪСКВАЧ

· Регулируеми рамена с накрайници



№	Размери	Пакет
45399		12



FESTA
AQUATIC

РАЗПРЕДЕЛИТЕЛ
ЗА НАПОЯВАНЕ

· Лесно управление на потока



№	Размери	Пакет
45400		6



FESTA
AQUATIC

РАЗПРЕДЕЛИТЕЛ
ЗА НАПОЯВАНЕ

· Лесно управление на потока



№	Размери	Пакет
45401		6



ROSA**ПИСТОЛЕТ
ЗА ПОЛИВАНЕ**

- 10 функции
- Преден спусък с опция за заключване

0,7 bar min
5,5 bar max



№ 45124 Размери 12

ROSA**ПИСТОЛЕТ
ЗА ПОЛИВАНЕ**

- 10 функции
- Преден спусък с опция за заключване
- Лесно управление на потока

0,7 bar min
5,5 bar max



№ 45125 Размери 12

ROSA

Watering system

**ROSA****ПИСТОЛЕТ
ЗА ПОЛИВАНЕ**

- 7 функции
- Спусък с опция за заключване

0,7 bar min
5,5 bar max



№ 45126 Размери 12

ROSA**ПИСТОЛЕТ
ЗА ПОЛИВАНЕ, DELUX**

- 7 функции
- Спусък с опция за заключване
- Лесно управление на потока

0,7 bar min
5,5 bar max



№ 45123 Размери 12
Метален

ROSA**ПИСТОЛЕТ
ЗА ПОЛИВАНЕ**

- 6 функции
- Спусък с опция за заключване
- Лесно управление на потока

0,7 bar min
5,5 bar max



№ 45117 Размери 12

ROSA**ПИСТОЛЕТ
ЗА ПОЛИВАНЕ, DELUX**

- 6 функции
- Спусък с опция за заключване
- Лесно управление на потока

0,7 bar min
5,5 bar max



№ 45118 Размери 12
Метален

ROSA**ПИСТОЛЕТ
ЗА ПОЛИВАНЕ**

- 5 функции
- Спусък с опция за заключване
- Лесно управление на потока

0,7 bar min
5,5 bar max



№ 45110 Размери 12

ROSA**ПИСТОЛЕТ
ЗА ПОЛИВАНЕ**

- Розетка
- Лесно управление на потока

0,7 bar min
5,5 bar max



№ 45116 Размери 12

ROSA

ПИСТОЛЕТ ЗА ПОЛИВАНЕ

- Метален
- Спусък с опция за заключване
- Лесно управление на потока



№	Размери	Колонки	Иконки
45120		12	

ROSA

ПИСТОЛЕТ ЗА ПОЛИВАНЕ

- Спусък с опция за заключване
- Лесно управление на потока



№	Размери	Колонки	Иконки
45115		12	

ROSA

ПИСТОЛЕТ ЗА ПОЛИВАНЕ

- Метален
- Спусък с опция за заключване
- Лесно управление на потока



№	Размери	Колонки	Иконки
45122	Метален	12	

ROSA

КОМПЛЕКТ С ПИСТОЛЕТ ЗА ПОЛИВАНЕ

- Спусък с опция за заключване
- Лесно управление на потока



2x



№	Размери	Колонки	Иконки
45114	1/2 конектор за маркуч	12	

ROSA

ПИСТОЛЕТ ЗА ПОЛИВАНЕ

- Спусък с опция за заключване
- Лесно управление на потока



№	Размери	Колонки	Иконки
45111		12	

ROSA

КОМПЛЕКТ С ПИСТОЛЕТ ЗА ПОЛИВАНЕ

- 6 функции
- Спусък с опция за заключване
- Лесно управление на потока



4x



№	Размери	Колонки	Иконки
45181		12	

ROSA

РАЗПРЪСКВАЧ ЗА ПОЛИВАНЕ

- Регулируемо напояване

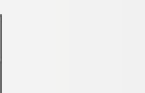

№	Размери	Колонки	Иконки
45214		48	

ROSA

РАЗПРЪСКВАЧ ЗА ПОЛИВАНЕ

- Изчистени линии, класическа връзка



№	Размери	Колонки	Иконки
45112		32	

ROSA

РАЗПРЪСКВАЧ ЗА ПОЛИВАНЕ

- Регулируемо напояване

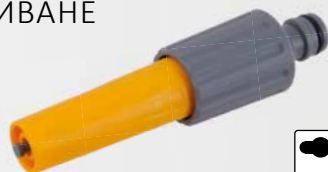

№	Размери	Колонки	Иконки
45113		60	

ROSA

КОМПЛЕКТ С РАЗПРЪСКВАЧ ЗА ПОЛИВАНЕ

- Регулируемо напояване



4x



№	Размери	Колонки	Иконки
45180		12	



ROSA

СЪЕДИНИТЕЛ ЗА МАРКУЧ



№ 45140 Размери 1/2" MOQ 60

ROSA

КОНЕКТОР ЗА МАРКУЧ



№ 45142 Размери 1/2" MOQ 60

ROSA

КОНЕКТОР СЪС СТОП КЛАПАН ЗА МАРКУЧ



№ 45138 Размери 1/2" MOQ 60

ROSA

СЪЕДИНИТЕЛ ЗА МАРКУЧ



№ 45296 Размери 1/2" MOQ 20

ROSA

КОНЕКТОР ЗА МАРКУЧ



№ 45298 Размери 1/2" MOQ 20

ROSA

КОНЕКТОР СЪС СТОП КЛАПАН ЗА МАРКУЧ



№ 45294 Размери 1/2" MOQ 20

ROSA

КОНЕКТОР ЗА МАРКУЧ



№ 45141 Размери 3/4" MOQ 60

ROSA

КОНЕКТОР ЗА МАРКУЧ



№ 45143 Размери 3/4" MOQ 60

ROSA

КОНЕКТОР СЪС СТОП КЛАПАН ЗА МАРКУЧ



№ 45139 Размери 3/4" MOQ 60

ROSA

КОНЕКТОР ЗА МАРКУЧ



№ 45297 Размери 3/4" MOQ 20

ROSA

КОНЕКТОР ЗА МАРКУЧ



№ 45299 Размери 3/4" MOQ 20

ROSA

КОНЕКТОР СЪС СТОП КЛАПАН ЗА МАРКУЧ



№ 45295 Размери 3/4" MOQ 20

ROSA

РЕДУКТОР 1/2" - 3/4"



№ 45213 Размери 1/2" - 3/4" MOQ 60

ROSA

РЕДУКТОР 3/4" - 1"



№ 45216 Размери 3/4" - 1" MOQ 48

ROSA

КОНЕКТОР ЗА МАРКУЧ



№ 45218 Размери 1" MOQ 48

ROSA
АДАПТЕР



№	Размери	
45130	1/2" + 3/4"	60
45131	3/4" + 1"	60

ROSA
АДАПТЕР



№	Размери	
45217	1"	48

ROSA
КОНЕКТОР ЗА МАРКУЧ



№	Размери	
45219	1"	48

ROSA
АДАПТЕР



№	Размери	
45289	1/2" + 3/4"	MOQ 20
45290	3/4" + 1"	MOQ 20

ROSA
КОМПЛЕКТ КОНЕКТОРИ



№	Размери	
45144	1/2"	60

ROSA
КОНЕКТОР,
ЕДНОПОСОЧЕН
С вентил



№	Размери	
45135	3/4"	60

ROSA
АДАПТЕР



№	Размери	
45133	3/4"	60

ROSA
АДАПТЕР



№	Размери	
45132	3/4"	60

ROSA
АДАПТЕР

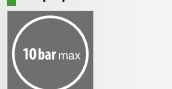

№	Размери	
45136		60

ROSA
АДАПТЕР

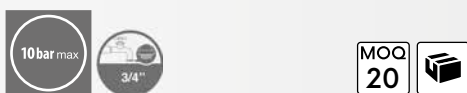

№	Размери	
45292	3/4"	MOQ 20

ROSA
АДАПТЕР

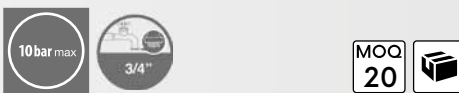

№	Размери	
45291	3/4"	MOQ 20

ROSA
АДАПТЕР



№	Размери	
45293		MOQ 20

ROSA
АДАПТЕР

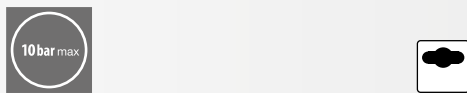

№	Размери	
45137		60

ROSA
АДАПТЕР



№	Размери	
45215	1"	48

ROSA
АДАПТЕР



№	Размери	
45145	1/2"	60

ROSA

РАЗПРЪСКВАЧ

· Дефлекторен

№	Размери	
45160		25

ROSA

РАЗПРЪСКВАЧ

· За морава, с вентили

№	Размери	
45156		12

ROSA

ТАЙМЕР ЗА НАПОЯВАНЕ

· 0 - 120 min.

№	Размери		
45147		24	

ROSA

ИМПУЛСЕН РАЗПРЪСКВАЧ, МЕСИНГ

· Месинг

№	Размери		
45150		12	

ROSA

ИМПУЛСЕН РАЗПРЪСКВАЧ

№	Размери		
45151		12	

ROSA

ИМПУЛСЕН РАЗПРЪСКВАЧ

№	Размери		

45168	Пластмасов	12
45169	Метален	12

ROSA

ИМПУЛСЕН РАЗПРЪСКВАЧ

№	Размери	
45161	plastový hrot	20

ROSA

РАЗПРЪСКВАЧ

· 3 рамена
· Двупосочен

№	Размери		
45164	Пластмасов	12	

ROSA

ПОСТАВКА ЗА РАЗПРЪСКВАЧ

№	Размери		
45159		12	

ROSA

ПОСТАВКА ЗА РАЗПРЪСКВАЧ

№	Размери	
45179		12

ROSA

ВОДАЧ ЗА МАРКУЧ

№	Размери	
45186		48

ROSA

ИМПУЛСЕН РАЗПРЪСКВАЧ

№	Размери	
45185		20

ROSA

ИМПУЛСЕН РАЗПРЪСКВАЧ

№	Размери	
45184		20

ROSA

СЪЕДИНИТЕЛ
ЗА МАРКУЧ,
МЕСИНГ



№ 45192 Размери 1/2"

48

ROSA

КОНЕКТОР
ЗА МАРКУЧ,
МЕСИНГ



№ 45194 Размери 1/2"

48

ROSA

КОНЕКТОР
СЪС СТОП КЛАПАН,
МЕСИНГ



№ 45190 Размери 1/2"

48

ROSA

СЪЕДИНИТЕЛ
ЗА МАРКУЧ,
МЕСИНГ

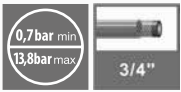

№ 45193 Размери 3/4"

48

ROSA

КОНЕКТОР
ЗА МАРКУЧ,
МЕСИНГ



№ 45195 Размери 3/4"

48

ROSA

КОНЕКТОР
СЪС СТОП КЛАПАН,
МЕСИНГ



№ 45191 Размери 3/4"

48

ROSA

АДАПТЕР,
МЕСИНГ



№ 45196 Размери С външна резба 1/2" + 3/4"

48

ROSA

АДАПТЕР,
МЕСИНГ



№ 45197 Размери С външна резба 3/4"

48

ROSA

АДАПТЕР,
МЕСИНГ



№ 45199 Размери С външна резба 1"

48

ROSA

АДАПТЕР,
МЕСИНГ



№ 45198 Размери С външна резба 3/4 + 1"

48

ROSA

АДАПТЕР,
МЕСИНГ



№ 45200 Размери С външна резба 3/4"

48

ROSA

АДАПТЕР,
МЕСИНГ



№ 45206 Размери Регулируем

48

ROSA

АДАПТЕР,
МЕСИНГ



№ 45203 Размери С 2 конектора

48

ROSA

АДАПТЕР,
МЕСИНГ



№ 45204 Размери С 3 конектора

48

СЪЕДИНИТЕЛ
ЗА МАРКУЧ
С МЕСИНГ РЕЗБА



№ 45211 Размери 1", резба 1"

25

ROSA

КОМПЛЕКТ ЗА
УПЛЪТНЯВАНЕ

· За артикули
45110, 45111, 45118, 45120, 45121, 45123,
45125, 45126, 45130, 45131, 45132, 45134,
45135, 45152, 45153, 45154, 45155, 45156,
45162, 45177, 45178, 45180, 45196, 45197,
45198



№ 45175 Размери



1

ROSA

УПЛЪТНИТЕЛ
ЗА КОНЕКТОР

50x

№ 45187 Размери



1



NEW



ROSA

ГРАДИНСКИ МАРКУЧ,
ПРОЗРАЧЕН



№	Размери	
45342	1/2" 10 m	1
45343	1/2" 15 m	1
45344	1/2" 20 m	1
45345	1/2" 25 m	1
45346	1/2" 50 m	1
45341	3/4" 10 m	1
45347	3/4" 15 m	1
45348	3/4" 20 m	1
45349	3/4" 25 m	1
45351	3/4" 50 m	1
45352	1" 15 m	1
45353	1" 25 m	1
45354	1" 50 m	1

NEW



FESTA
AQUATIC

ГРАДИНСКИ МАРКУЧ,
ПРОФИ



№	Размери	
45372	1/2" 25 m	1
45373	1/2" 50 m	1
45374	3/4" 25 m	1
45375	3/4" 50 m	1
45376	1" 25 m	1
45377	1" 50 m	1



ROSA

КОМПЛЕКТ
СПИРАЛЕН МАРКУЧ



№	Размери	
45300	7,5 m	6
45301	15 m	8



ROSA

МАКАРА ЗА МАРКУЧ



№	Размери	
45178	1/2" 60 m	5



ROSA

МЕТАЛНА МАКАРА ЗА
МАРКУЧ НА КОЛИЧКА



№	Размери	
45183	1/2" 60 m	5



ROSA

МАКАРА ЗА МАРКУЧ НА
КОЛИЧКА



№	Размери	
45177	1/2" 60 m	5



ROSA

МАКАРА
ЗА МАРКУЧ

№	Размери		
45182	1/2" 40 m	4	1

ROSA

МАКАРА
ЗА МАРКУЧ,
САМОНАВИВАЩА

· С включен маркуч 1/2" 20 m



№	Размери		
45176	1/2"	1	1



ROSA

ПОСТАВКА ЗА МАРКУЧ

№	Размери	
45174	60	1



ПОСТАВКА ЗА ОКАЧВАНЕ НА МАРКУЧ

· Макс. 30 m, 1/2" пластмасов маркуч

№	Размери	
45350	Макс. товароносимост 20 kg	1

СЪЕДИНИТЕЛ ЗА МАРКУЧ

№	Размери	MOQ	Короб
45220	1/2" резба 3/4"	10	
45221	3/4" резба 1"	10	
45222	1" резба 1"	10	



НАКРАЙНИК ЗА МАРКУЧ

№	Размери	MOQ	Короб
45223	1/2" резба 3/4"	10	
45224	3/4" резба 1"	10	
45225	1" резба 1"	10	



РЕДУКТОР ЗА МАРКУЧ

№	Размери	MOQ	Короб
45226	1/2" - 3/4" резба 1"	10	
45227	1" - 3/4" резба 1"	10	
45228	1" - 1/2" резба 1"	10	



РАЗПРЪСКВАЧ

№	Размери	MOQ	Короб
45229		10	



№	Диаметър	MOQ	Короб
45603	16 - 25 mm	2	
45604	20 - 32 mm	2	
45605	25 - 40 mm	2	
45606	30 - 45 mm	2	
45607	32 - 50 mm	2	
45608	40 - 60 mm	2	
45609	50 - 70 mm	2	
45610	60 - 80 mm	2	
45611	70 - 90 mm	2	
45612	80 - 100 mm	2	
45613	90 - 110 mm	2	
45614	100 - 120 mm	2	
45615	110 - 130 mm	2	
45616	120 - 140 mm	2	
45617	130 - 150 mm	2	
45618	140 - 160 mm	2	
45619	150 - 170 mm	2	



№	Диаметър	Широчина	MOQ	Короб
45623	16 - 25 mm	9 mm	2	
45624	20 - 32 mm	9 mm	2	
45625	25 - 40 mm	12 mm	2	
45626	30 - 45 mm	12 mm	2	
45627	32 - 50 mm	12 mm	2	
45628	40 - 60 mm	12 mm	2	
45629	50 - 70 mm	12 mm	2	
45630	60 - 80 mm	12 mm	2	
45631	70 - 90 mm	12 mm	2	
45632	80 - 100 mm	12 mm	2	
45633	90 - 110 mm	12 mm	2	
45634	100 - 120 mm	12 mm	2	
45635	110 - 130 mm	12 mm	2	
45636	120 - 140 mm	12 mm	2	
45637	130 - 150 mm	12 mm	2	
45638	140 - 160 mm	12 mm	2	
45639	150 - 170 mm	12 mm	2	

СКОБА ЗА МАРКУЧ,
ПОЦИНКОВАНА

№	Диаметър	MOQ	Короб
45600	8 - 12 mm	2	
45601	10 - 16 mm	2	
45602	12 - 20 mm	2	

СКОБА, НЕРЪЖДАЕМА
СТОМАНА

№	Диаметър	Широчина	MOQ	Короб
45620	8 - 12 mm	9 mm	2	
45621	10 - 16 mm	9 mm	2	
45622	12 - 20 mm	9 mm	2	

ГРАДИНСКИ КРАН, ДВОЕН

№	MOQ	Короб
45105	8	



ГРАДИНСКИ КРАН

№	Размери	MOQ	Короб
45100	1/2"	12	
45101	3/4"	10	
45102	1"	6	



КРАН, СФЕРИЧЕН

№	Размери	MOQ	Короб
45106	1/2"	12	
45107	3/4"	10	
45108	1"	8	

ГРАДИНСКА ЛЕЙКА,
ПЛАСТАСОВАMADE IN
EU

№	Размери	MOQ	Короб
45280	2,5 l	10	
45283	5 l	10	
45285	10 l	10	
45286	12 l	10	
45287	15 l	10	



ЪГЛОВ КЛАПАН

№	Размери	MOQ	Короб
45104	1/2" x 3/8"	10	





FESTA

ГРАДИНСКА ПРЪСКАЧКА ПОД НАЛЯГАНЕ, 12 L

Макс. налягане	2,5 Bar
Обем	12 l
Дължина на маркуча	3 m
Размери	32 x 25 x 59 cm



№	Размери	Икон
45249	Пръскачка 12 l	1

FESTA

ГРАДИНСКА ПРЪСКАЧКА ПОД НАЛЯГАНЕ

№	Размери	Икон
45247	12 l	1
45248	16 l	1



№	Размери	Икон
45263	Резервен маркуч	1
45251	Комплект резервни уплътнители	1
45254	Резервна дюза	1
45257	Резервна дръжка	1
45261	Резервен прът - 370 mm	1
45267	Резервен прът 45 - 250 cm	1
45268	Резервен прът 65 - 260 cm	1

FESTA

ГРАДИНСКА ПРЪСКАЧКА ПОД НАЛЯГАНЕ

№	Размери	Икон
45244	3 l	6
45245	5 l	6
45246	8 l	6



№	Размери	Икон
45262	Резервен маркуч	1
45250	Комплект резервни уплътнители	1
45253	Резервна дюза	1
45256	Резервна дръжка	1
45260	Резервен прът - 370 mm	1

· Подходящ за: 45244, 45245, 45246



· Подходящ за: 45247, 45248

93 - 250 cm

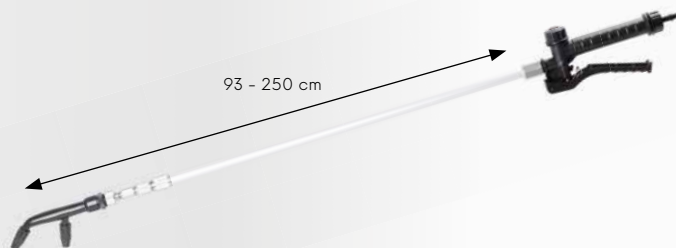

ТЕЛЕСКОПИЧЕН ПРЪТ ЗА ПРЪСКАЧКА

№	тип	Икон
45267	45 - 250 cm	Неръждаема стомана
45268	65 - 260 cm	Фибростъкло

ТЕЛЕСКОПИЧЕН ПРЪТ ЗА ПРЪСКАЧКА

№	Размери	Икон
45269		1



РЕЗЕРВЕН МАРКУЧ ЗА ПРЪСКАЧКА

№	тип	Икон
45263	За пръскачка 45247, 45248	1
45262	За пръскачка 45244, 45245, 45246	1



ФУНИЯ ЗА ХЕРБИЦИДИ

№	velikost	Дължина на	Широчина	височина	Икон
45265	Малък	230 mm	90 mm	130 mm	1
45266	Голям	370 mm	140 mm	200 mm	1



FESTA

РЪЧНА ПРЪСКАЧКА



№	тип	
45242	1,5 l	20
45241	2 l	20

РЪЧНА ПРЪСКАЧКА



№	тип	
45239	0,5 l	1
45240	0,7 l	1



45173

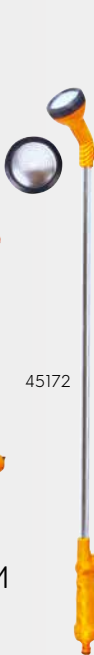

45172

ROSA

ГРАДИНСКИ ДУШ



№	Размери	
45171	Регулируем	12

ROSA

ГРАДИНСКИ ДУШ



№	Размери	
45170	Трипод	6

ROSA

ГРАДИНСКИ ДУШ, РЪЧЕН



№	Размери	
45172	С вентил	12
45173	10 функции	12



FESTA[®]

system click
ON - OFF

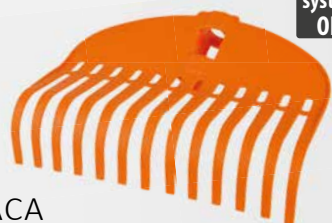

system click
ON - OFF



system click
ON - OFF

FESTA

ГРЕБЛО, ПЛАСТМАСА

№	Брой зъби	Широчина	височина	
45327	13	240 mm	200 mm	12

FESTA

ГРЕБЛО, ПЛАСТМАСА

№	Брой зъби	Широчина	
45325	12	410 mm	12



system click
ON - OFF



system click
ON - OFF

FESTA

ГРЕБЛО, ПЛАСТМАСА

№	Брой зъби	Широчина	височина	
45328	23	480 mm	280 mm	12

FESTA

ГРЕБЛО, ПЛАСТМАСА

№	Брой зъби	Широчина	
45326	18	580 mm	12



system click
ON - OFF



system click
ON - OFF

FESTA

ГРЕБЛО, ПЛАСТМАСА

№	Брой зъби	Широчина	височина	
45329	35	760 mm	310 mm	1

FESTA

ЧЕТКА

№	Размери	
45323	37 cm	16

FESTA

ДРЪЖКА, АЛУМИНИЙ

ALU



system click
ON - OFF

№	Размери	
45330	161 cm	24
45331	100 cm	24

**FESTA**

МЕТАЛНО ГРЕБЛО,
РЕГУЛИРУЕМО,
ТЕЛЕСКОПИЧНО



Zn

№	Брой зъби	Обхват	
44965	15	200 - 590 mm	12

МЕТАЛНО ГРЕБЛО, РЕГУЛИРУЕМО



Zn

№	Брой зъби	Тегло	Обхват	
45050	15	1200 g	200 - 590 mm	25

FESTA

МЕТАЛНО ГРЕБЛО

· Пружинна стомана

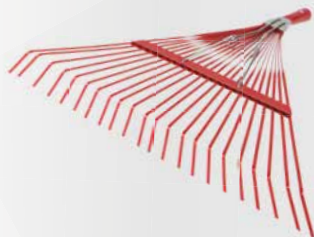

№	Широчина	Брой зъби	
45071	55 cm	22	1

FESTA

МЕТАЛНО
ГРЕБЛО
С ДРЪЖКА

MOQ
3

№	Широчина	Дължина на дръжката	
61150	55 cm	160 cm	3



МЕТАЛНО ГРЕБЛО, ТЕЛЕНО

№	Широчина	Брой зъби	
45051	40 cm	22	60

МЕТАЛНО
ГРЕБЛО

MOQ
3

№	Широчина	Дължина на дръжката	
61130	40 cm	160 cm	3



МЕТАЛНО ГРЕБЛО, ТЕЛЕНО

№	Широчина	Брой зъби	
45052	45 cm	22	36

МЕТАЛНО
ГРЕБЛО
С ДРЪЖКА

MOQ
3

№	Широчина	Дължина на дръжката	
61131	45 cm	160 cm	3

ПЛАСТМАСОВО ГРЕБЛО



№	Широчина	Брой зъби	
45320	60 cm	24	10



ПЛАСТМАСОВО ГРЕБЛО С ДРЪЖКА



№	Широчина	Брой зъби	Дължина на дръжката	
61132	60 cm	24	160 cm	3



MOQ
3

ПЛАСТМАСОВО ГРЕБЛО



№	Широчина	Брой зъби	
45055	50 cm	22	10



ПЛАСТМАСОВО ГРЕБЛО С ДРЪЖКА



№	Широчина	Брой зъби	Дължина на дръжката	
61133	50 cm	22	160 cm	3



MOQ
3

ПЛАСТМАСОВО ГРЕБЛО



№	Широчина	Брой зъби	
45321	40 cm	23	20



ПЛАСТМАСОВО ГРЕБЛО С ДРЪЖКА



№	Брой зъби	Дължина на дръжката	
61134	23	160 cm	3



MOQ
3

ПЛАСТМАСОВО ГРЕБЛО



№	Широчина	Брой зъби	
45054	40 cm	23	10



ПЛАСТМАСОВО ГРЕБЛО С ДРЪЖКА



№	Широчина	Брой зъби	Дължина на дръжката	
61135	40 cm	23	160 cm	3



MOQ
3

ПЛАСТМАСОВО ГРЕБЛО



№	Широчина	Брой зъби	
45053	58 cm	16	35



ПЛАСТМАСОВО ГРЕБЛО С ДРЪЖКА



№	Широчина	Брой зъби	Дължина на дръжката	
61141	58 cm	16	160 cm	3



MOQ
3

ПЛАСТМАСОВО ГРЕБЛО С ИЗРАВНЯВАЩ РЪБ



№	Широчина	Брой зъби	
45070	41 cm	14	4

ПЛАСТМАСОВО ГРЕБЛО С ДРЪЖКА И ИЗРАВНЯВАЩ РЪБ



MOQ
3

№	Широчина	Брой зъби	Дължина на дръжката	
61142	41 cm	14	160 cm	3

МЕТАЛНО ГРЕБЛО



№	Широчина	Брой зъби	
61030	24 cm	10	24
61031	29 cm	12	24
61032	34 cm	14	24
61033	40 cm	16	24

МЕТАЛНО ГРЕБЛО С ДРЪЖКА



MOQ
3

№	Широчина	Брой зъби	Дължина на дръжката	
61060	24 cm	10	160 cm	3
61061	29 cm	12	160 cm	3
61062	34 cm	14	160 cm	3
61063	40 cm	16	160 cm	3

ГРЕБЛО ЗА ВЕРТИКУЛИРАНЕ, МЕТАЛНО

· С покритие



№	Широчина	Брой зъби	
61045	30 cm	12	25
61046	39 cm	14	25
61047	45 cm	16	25

ГРЕБЛО ЗА ВЕРТИКУЛИРАНЕ, МЕТАЛНО, С ДЪРВЕНА ДРЪЖКА



MOQ
3

№	Широчина	Брой зъби	Дължина на дръжката	
61143	30 cm	12	160 cm	3
61144	39 cm	14	160 cm	3
61145	45 cm	16	160 cm	3

ГРЕБЛО ЗА ВЕРТИКУЛИРАНЕ



№	Широчина	Брой зъби	
61048	35 cm	11 21	12

ГРЕБЛО ЗА ВЕРТИКУЛИРАНЕ С ДРЪЖКА



MOQ
3

№	Широчина	Брой зъби	Дължина на дръжката	
61146	35 cm	11 21	160 cm	3

МЕТАЛНО ГРЕБЛО С ДРЪЖКА, ФИБРОСТЪКЛО



MOQ
3

№	Широчина	Брой зъби	Дължина на дръжката	
61034	34 cm	14	160 cm	3



FESTA

ЛОПАТА СЪС
ЗАОСТРЕН ВРЪХ

№	Размери	Дължина на дръжката	
61006	19 x 28 cm	120 cm	5



FESTA

ЛОПАТА СЪС
ЗАОСТРЕН ВРЪХ,
МАЛКА, КЪСА

· Подходяща за градината

№	Размери	Дължина на дръжката	
61008	19 x 28 cm	85 cm	5



FESTA

ЛОПАТА СЪС
ЗАОБЛЕН
РЪБ

№	Размери	Дължина на дръжката	
61005	20 x 29 cm	120 cm	5



FESTA



FESTA

ЛОПАТА СЪС ЗАОБЛЕН РЪБ,
УДЪЛЖЕНА

· За човек с височина над 180 cm

№	Размери	Дължина на дръжката	
61157	20 x 29 cm	130 cm	5

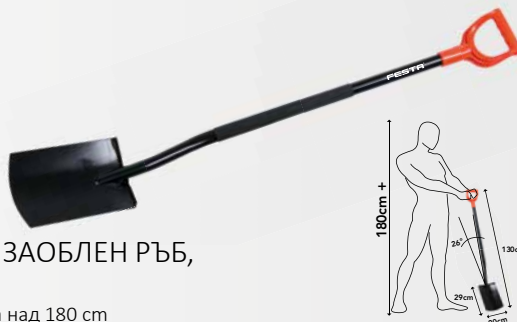

FESTA

ЛОПАТА СЪС ЗАОСТРЕН ВРЪХ,
УДЪЛЖЕНА

· За човек с височина над 180 cm

№	Размери	Дължина на дръжката	
61158	19 x 28 cm	130 cm	5



FESTA

ЛОПАТА
ЗА НАСИПНИ
ТОВАРИ,
СТАНДАРТНА

№	Размери	Дължина на дръжката	
61155	24 x 29 cm	120 cm	5



FESTA

ВИЛА

№	Размери	Дължина на дръжката	
61156	19 x 28 cm	130 cm	5



FESTA

ВИЛА

№	Размери	Дължина на дръжката	
61007	18 x 28 cm	130 cm	5



ВИЛА
С ДРЪЖКА ОТ
ФИБРОСТЪКЛО

№	Размери	Дължина на дръжката	
61010	18 x 30 cm	95 cm	12



ЛОПАТА СЪС
ЗАОСТРЕН ВРЪХ,
С ДРЪЖКА ОТ
ФИБРОСТЪКЛО

№	Размери	Дължина на дръжката	
61029	19 x 30 cm	105 cm	12



ЛОПАТА
С ДРЪЖКА ОТ
ФИБРОСТЪКЛО

№	Размери	Дължина на дръжката	
61015	19 x 30 cm	105 cm	12





ЛОПАТА ЗА ВЪГЛИЩА, АЛУМИНИЕВА, С ДРЪЖКА

· Дървена дръжка, бук

ALU		MOQ	3
№	Размери	Дължина на дръжката	
61057	26 x 29 cm	130 cm	3
61056	34 x 30 cm	130 cm	3



ЛОПАТА ЗА ВЪГЛИЩА, АЛУМИНИЕВА

ALU		MOQ	10
№	Размери		
61026	26 x 29 cm		10
61025	34 x 30 cm		10



ЛОПАТА ЗА ВЪГЛИЩА С ДРЪЖКА

MOQ		3
№	Размери	Дължина на дръжката
61089	35 x 35 cm	130 cm



ЛОПАТА ЗА ВЪГЛИЩА

MOQ		10
№	Размери	
61021	35 x 35 cm	10



ЛОПАТА ЗА НАСИПНИ ТОВАРИ, СЪС ЗАОБЛЕН ВРЪХ, С ДРЪЖКА

· С покритие · Дървена дръжка, бук

MOQ		3
№	Размери	Дължина на дръжката
61050	26 x 28 cm	130 cm



ЛОПАТА СЪС ЗАОБЛЕН ВРЪХ

MOQ		12
№	Размери	
61000	26 x 28 cm	12



ЛОПАТА СЪС ЗАОБЛЕН ВРЪХ И С ДРЪЖКА

· Дървена дръжка, бук

MOQ		3
№	Размери	Дължина на дръжката
61088	26 x 28 cm	130 cm



ЛОПАТА СЪС ЗАОБЛЕН ВРЪХ

MOQ		12
№	Размери	
61020	26 x 28 cm	12



ЛОПАТА ЗА НАСИПНИ ТОВАРИ, СТАНДАРТНА, С ДРЪЖКА

· С покритие · Дървена дръжка, бук

MOQ		3
№	Размери	Дължина на дръжката
61051	24 x 29 cm	130 cm



ЛОПАТА СТАНДАРТНА

MOQ		12
№	Размери	
61001	24 x 29 cm	12





ЛОПАТА СТАНДАРТНА

№	Размери	12
61022	24 x 29 cm	12



ЛОПАТА ЗА НАСИПНИ ТОВАРИ, СТАНДАРТНА, С ДРЪЖКА

· Дървена дръжка, бук

MOQ
3

№	Размери	Дължина на дръжката	3
61090	24 x 29 cm	130 cm	3
61053	24 x 29 cm	130 cm "T", дръжка	3



ЛОПАТА

№	Размери	12
61058	25 x 27 cm	12



ЛОПАТА С ДРЪЖКА

· Дървена дръжка, бук

MOQ
3

№	Размери	Дължина на дръжката	3
61059	25 x 27 cm	130 cm	3



ЗАКРИВЕНА ЛОПАТА ЗА НАСИПНИ ТОВАРИ

· С покритие

№	Размери	12
61002	19 x 27 cm	12



ЗАКРИВЕНА ЛОПАТА ЗА НАСИПНИ ТОВАРИ, С ДРЪЖКА

· С покритие · Дървена дръжка, бук

MOQ
3

№	Размери	Дължина на дръжката	3
61052	19 x 27 cm	130 cm	3



ЗАКРИВЕНА ЛОПАТА ЗА НАСИПНИ ТОВАРИ

№	Размери	12
61024	19 x 27 cm	12



ЗАКРИВЕНА ЛОПАТА ЗА НАСИПНИ ТОВАРИ, С ДРЪЖКА

№	Размери	Дължина на дръжката	3
61054	19 x 27 cm	130 cm	3



ПЛАСТМАСОВА ЛОПАТА

№	Размери	12
61027	24 x 26 cm	12



ПРАВА ЛОПАТА СЪС ЗАОСТРЕН ВРЪХ И Т-ОБРАЗНА ДРЪЖКА

· С покритие

№	Размери	Дължина на дръжката	MOQ
61161	22 x 30 cm	90 cm	3



ПРАВА ЛОПАТА СЪС ЗАОСТРЕН ВРЪХ

· С покритие

№	Размери	MOQ
61004	22 x 30 cm	12



ПРАВА ЛОПАТА СЪС ЗАОСТРЕН ВРЪХ И Т-ОБРАЗНА ДРЪЖКА

№	Размери	Дължина на дръжката	MOQ
61097	19 x 30 cm	90 cm	3



ПРАВА ЛОПАТА СЪС ЗАОСТРЕН ВРЪХ

№	Размери	MOQ
61019	22 x 30 cm	12



ЛОПАТА СЪС ЗАОСТРЕН ВРЪХ, КОВАНА, С Т-ОБРАЗНА ДРЪЖКА

№	Размери	Дължина на дръжката	MOQ
61162	22 x 25 cm	90 cm	3
61223	дръжка	90 cm	1



ЛОПАТА СЪС ЗАОСТРЕН ВРЪХ КОВАНА

№	Размери	MOQ
61013	22 x 25 cm	12



ЛОПАТА СЪС ЗАОБЛЕН РЪБ, С Т-ОБРАЗНА ДРЪЖКА

№	Размери	Дължина на дръжката	MOQ
61163	21 x 30 cm	90 cm	3



ЛОПАТА СЪС ЗАОБЛЕН РЪБ

№	Размери	MOQ
61003	21 x 30 cm	12



ЛОПАТА СЪС ЗАОБЛЕН РЪБ

№	Размери	
61018	21 x 30 cm	12



ЛОПАТА СЪС ЗАОБЛЕН РЪБ, С Т-ОБРАЗНА ДРЪЖКА

MOQ 3

№	Размери	Дължина на дръжката	
61098	21 x 30 cm	90 cm	3



ЛОПАТА ЗА КАНАЛИ

№	Размери	
61014	14 x 37 cm	12



ЛОПАТА ЗА КАНАЛИ С Т-ОБРАЗНА ДРЪЖКА

№	Размери	Дължина на дръжката	MOQ	
61164	14 x 37 cm	90 cm	3	3
61203	дръжка	90 cm		1



ВИЛА

№	Размери	
61009	20 x 32 cm	12



ВИЛА С Т-ОБРАЗНА ДРЪЖКА

MOQ 3

№	Размери	Дължина на дръжката	
61165	20 x 32 cm	90 cm	3



ВИЛА, КОВАНА

№	Размери	
61012	22 x 30 cm	12



ВИЛА, КОВАНА, С Т-ОБРАЗНА ДРЪЖКА

№	Размери	Дължина на дръжката	MOQ	
61166	22 x 30 cm	90 cm	3	3
61222	дръжка	90 cm		1



ВИЛА

№	Размери	
61044	20 x 30 cm	12



ВИЛА С Т-ОБРАЗНА ДРЪЖКА

№	Размери	Дължина на дръжката	MOQ	
61028	20 x 30 cm	90 cm	3	3
61209	дръжка	90 cm		1



МОТИКА СЪС ЗАОСТРЕН ВРЪХ,
КОВАНА, С ДРЪЖКА

№	Размери	Дължина на дръжката	MOQ	3
61111	0,4 kg	120 cm	MOQ	3
61112	0,6 kg	120 cm	MOQ	3
61224	дръжка	120 cm		1

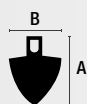

МОТИКА СЪС ЗАОСТРЕН
ВРЪХ, КОВАНА

№	Размери	A	B	MOQ
61035	0,4 kg	180 mm	125 mm	1
61036	0,6 kg	230 mm	160 mm	30



МОТИКА С ПРАВ РЪБ, КОВАНА,
С Т-ОБРАЗНА ДРЪЖКА

№	Размери	Дължина на дръжката	MOQ	3
61114	0,6 kg	120 cm	MOQ	3
61224	дръжка	120 cm		1

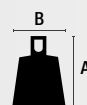

МОТИКА С ПРАВ РЪБ,
КОВАНА

№	Размери	A	B	MOQ
61038	0,6 kg	165 mm	135 mm	20



МОТИКА С ДРЪЖКА

MOQ
3

№	Размери	Дължина на дръжката	MOQ	3
61290	75 mm	120 cm		3
61291	125 mm	120 cm		3
61292	175 mm	120 cm		3

МОТИКА

№	Размери	MOQ
61067	75 mm	1
61068	125 mm	1
61069	175 mm	1



МОТИКА С ДРЪЖКА

MOQ
3

№	Размери	Дължина на дръжката	MOQ	3
61293	140 mm	120 cm		3

МОТИКА

№	Размери	MOQ
61070	140 mm	40



КИРКА, КОВАНА, С ДРЪЖКА

MOQ
3

№	Размери	Дължина на дръжката	MOQ	3
61121	1,5 kg	95 cm		3
61042	2,5 kg	95 cm		3

КИРКА, КОВАНА

№	Размери	MOQ
61120	1,5 kg	6
61040	2,5 kg	6



FESTA

ГРЕБЛО ЗА СНЯГ



№	Размери	
60006	46 x 34 cm	12
60206	46 x 34 cm, Сглобен	1

FESTA

ГРЕБЛО ЗА СНЯГ



№	Размери	
60008	50 x 34 cm	12
60208	50 x 34 cm, Сглобен	1

ГРЕБЛО ЗА СНЯГ



MADE IN EU

№	Размери	
60001	48 x 40 cm	10
60201	48 x 40 cm, Сглобен	1

ГРЕБЛО ЗА СНЯГ



ALU

№	Размери	
60012	50 x 38 cm	12
60212	50 x 38 cm, Сглобен	1



ЛЕДОТРОШАЧ

№	Размери		MOQ
60022	20 cm	3	3



СТЪРГАЛКА ЗА ЛЕД

№	Размери	
60018	15 cm	20
60019	20 cm	24
60020	30 cm	20
61201	дръжка 130 cm	10



СОЛ/ЛУГА ПРОТИВ ЗАМРЪЗВАНЕ

№	Размери	
43300	10 kg	1
43301	25 kg	1



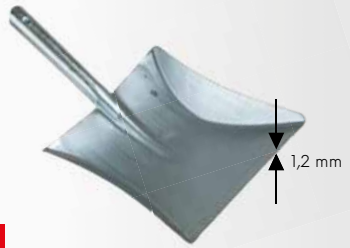

FESTA

ЛОПАТА, ПОЦИНКОВАНА, ПОДСИЛЕНА

№	Размери	Кол.
52176	22 x 23 cm	24

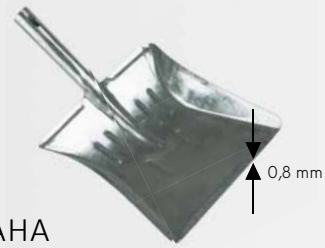

ЛОПАТА, ПОЦИНКОВАНА

Zn

№	Размери	Кол.
52175	22 x 23 cm	50



ЧЕТКА С ЛОПАТКА

MADE IN EU

№	Размери	Кол.
52168		26



ЧЕТКА С ЛОПАТКА

MADE IN EU

№	Размери	Кол.
52173		26



СТОМАНЕНА ЧЕТКА ЗА ПОЧИСТВАНЕ НА ФУГИ, С ДРЪЖКА

№	Дължина на дръжката	Кол.
52198	140 cm	1



ЧЕТКА С ДРЪЖКА

MADE IN EU

№	Размери	Кол.
52119	29 cm	24

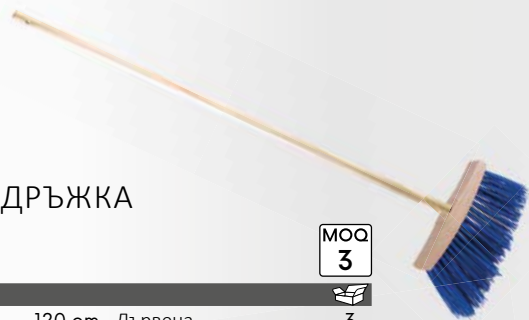

ЧЕТКА С ДРЪЖКА

MADE IN EU

MOQ 3

№	Размери	Кол.
52197	30 cm 120 cm Дървена	3



ЧЕТКА

MADE IN EU

№	Размери	Кол.
52108	30 cm	25
61172	дръжка 120 cm	1



ЧЕТКА С ДРЪЖКА

№	Размери	Кол.
52135	145 cm	1



system click ON - OFF

FESTA

ЧЕТКА

№	Размери	Кол.
45323	37 cm	16





ЧЕТКА



№	Размери	
52101	30 cm	10
52102	40 cm	10
52103	50 cm	10
52104	60 cm	10
52105	80 cm	10



ЧЕТКА С ДРЪЖКА



№	Размери	Дължина на дръжката	
52190	30 cm	150 cm	3
52191	40 cm	150 cm	3
52192	50 cm	150 cm	3
52193	60 cm	150 cm	3
52194	80 cm	150 cm	3



ЧЕТКА



№	Размери	
52160	40 cm	10
52161	50 cm	10
52162	60 cm	10
52163	70 cm	10
52164	80 cm	10



ЧЕТКА С ДРЪЖКА



№	Размери	Дължина на дръжката	
52185	40 cm	150 cm	3
52186	50 cm	150 cm	3
52187	60 cm	150 cm	3
52188	70 cm	150 cm	3
52189	80 cm	150 cm	3



ЧЕТКА



№	Размери	
52114	28 cm	С резба 1



ЧЕТКА С ДРЪЖКА



№	Размери	Дължина на дръжката	
52116	28 cm	130 cm	3



ЧЕТКА



№	Размери	
52113	30 cm	С резба 26
52115	30 cm	Без резба 26



ЧЕТКА С ДРЪЖКА



№	Размери	
52195	30 cm	150 cm Дървена 3
52196	30 cm	130 cm ALU 3



ШПАКЛА С ГУМА

№	Размери	
15886	450 mm	дръжка Ø 23 mm 48
15887	600 mm	дръжка Ø 23 mm 48
15888	750 mm	дръжка Ø 23 mm 32



ЧЕТКА С ДРЪЖКА



№	Размери	
52109	25 cm	120 cm Дървена 12

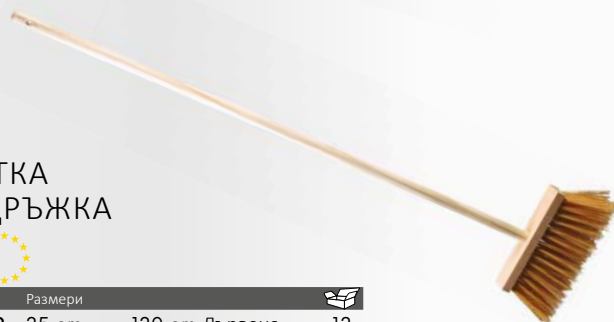



FESTA

ЧЕТКА, СТОМАНЕНА

№	Размери		
22135	6 x 19 cm	Без дръжка	8
22137	6 x 19 cm	С дръжка 140 cm	MOQ 3



FESTA

ЧЕТКА, ПЛАСТМАСОВА

№	Размери		
22136	6 x 19 cm	Без дръжка	8
22138	6 x 19 cm	С дръжка 140 cm	MOQ 3



АЛУМИНИЕВ МОП

№	Размери	
52110	30 cm	16



РЕЗЕРВЕН МОП

№	Размери	
52111	30 cm	1

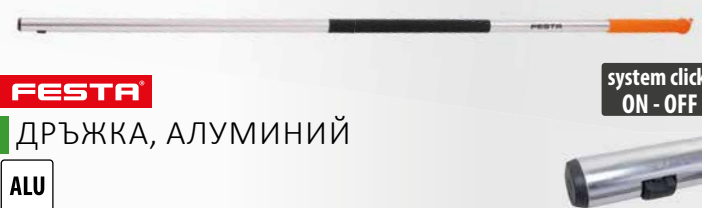

FESTA

ДРЪЖКА, АЛУМИНИЙ

№	Размери	
45330	161 cm	24
45331	100 cm	24

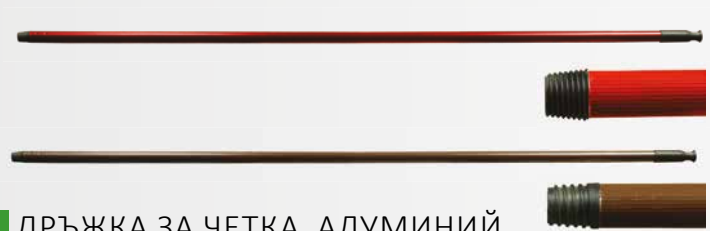

ДРЪЖКА ЗА ЧЕТКА, АЛУМИНИЙ

№	Размери	
52126	130 cm, с резба	1

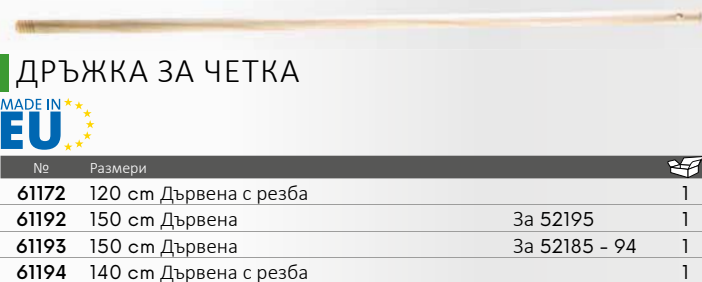

ДРЪЖКА ЗА ЧЕТКА

№	Размери	
61172	120 cm Дървена с резба	1
61192	150 cm Дървена	За 52195 1
61193	150 cm Дървена	За 52185 - 94 1
61194	140 cm Дървена с резба	1



ДРЪЖКА ЗА ЧЕТКА

№	Размери		№	Размери	
61171	1,2 m	1	61175	1,6 m	1
61173	1,4 m	1	61176	1,7 m	1
61174	1,5 m	1	61177	1,8 m	1

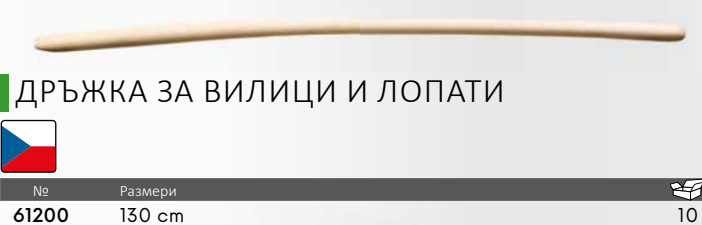

ДРЪЖКА ЗА ВИЛИЦИ И ЛОПАТИ

№	Размери	
61200	130 cm	10



ДРЪЖКА ЗА ЛОПАТА

№	Размери	
61201	130 cm, Права	10



ДРЪЖКА ЗА ЛОПАТА, Т-ОБРАЗНА

№	Размери	
61208	90 cm	10

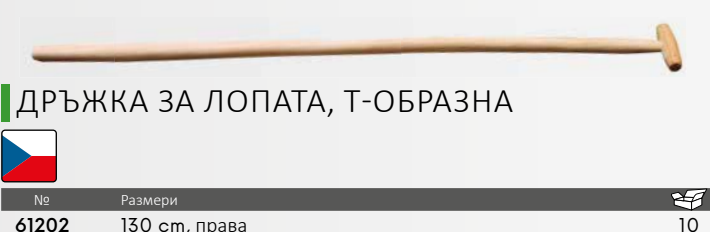

ДРЪЖКА ЗА ЛОПАТА, Т-ОБРАЗНА

№	Размери	
61202	130 cm, права	10

ДРЪЖКА ЗА ГРЕБЛО И МАСТАР ЗА БЕТОН



№	Размери	
61215	160 cm	10

ДРЪЖКА ЗА КИРКА



№	Размери	
61204	95 cm, извита (За 61120)	10
61205	95 cm	10

ДРЪЖКА ЗА ПЛАСТМАСОВО ГРЕБЛО



№	Размери	
61195	120 cm	10

ДРЪЖКА ЗА ГРЕБЛО



№	Размери	Подходяща за	
61250	160 cm	45051, 61048	20
61251	160 cm	45052	20
61252	160 cm	45320	20
61253	160 cm	45053	20
61254	160 cm	45054	20
61255	160 cm	45070	20
61256	160 cm	45055	20

ДРЪЖКА ЗА МОТИКА



№	Размери	
61207	100 cm	10

ДРЪЖКА ЗА МОТИКА



№	Размери	
61219	120 cm	10

ДРЪЖКА ЗА МЕТАЛНО ГРЕБЛО



№	Размери	
61183	150 cm	10
61184	160 cm	10
61189	170 cm	10
61190	180 cm	10

ДРЪЖКА, ПЛАСТМАСОВА, У-ОБРАЗНА

№	Размери	
61230		10



61079



120 cm

80 cm

№	
61005	15
61006	15
61050	15
61051	15
61052	15
61079	1
61097	15
61098	15

61077



• Илюстративна снимка

СТЕЛАЖ ЗА ЛОПАТИ И МОТИКИ

№	Размери	
61077	Стелаж с артикули	1
61079	Стелаж с палет	1

ДЪРЖАЧ ЗА ГРАДИНСКИ ИНСТРУМЕНТИ

5x

№	Размери	
51184		12



Въртящи се гумени ролки

ДЪРЖАЧ ЗА ГРАДИНСКИ ИНСТРУМЕНТИ

№	Размери	
51185	45 cm	15



Илюстративна снимка



МРЕЖА ПРОТИВ НАСЕКОМИ

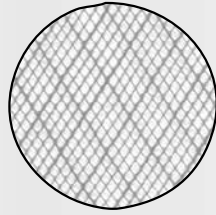

№	Размери		
40100	1 x 25 m - PE бяла		1
40120	1,2 x 25 m - PE бяла		1

МРЕЖА ПРОТИВ НАСЕКОМИ

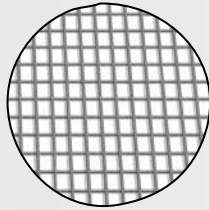

ALU **Zn**

№	Размери		
42101	1 x 30 m - ALUMINIUM		2
42103	1 x 30 m - Галванизирана		2

МРЕЖА ПРОТИВ НАСЕКОМИ

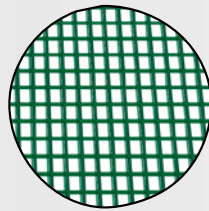

№	Размери		
42102	1 x 30 m - Зелена, с покритие		2

МРЕЖА ПРОТИВ НАСЕКОМИ, ФИБРОСТЪКЛО

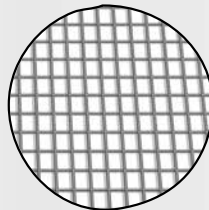

№	Размери			
41083	0,8 x 30 m	Бяла	6	
41103	1 x 30 m	Бяла	6	
41123	1,2 x 30 m	Бяла	6	
41153	1,5 x 30 m	Бяла	6	

№	Размери			
41082	0,8 x 30 m	Бяла-сива	6	
41102	1 x 30 m	Бяла-сива	6	
41122	1,2 x 30 m	Бяла-сива	6	
41152	1,5 x 30 m	Бяла-сива	6	

№	Размери			
41050	0,5 x 30 m	Сива	6	
41080	0,8 x 30 m	Сива	6	
41100	1 x 30 m	Сива	6	
41120	1,2 x 30 m	Сива	6	
41150	1,5 x 30 m	Сива	6	

№	Размери			
41081	0,8 x 30 m	Черна	6	
41101	1 x 30 m	Черна	6	
41121	1,2 x 30 m	Черна	6	
41151	1,5 x 30 m	Черна	6	





МРЕЖА ПРОТИВ НАСЕКОМИ, БЯЛА



№	Размери	Дължина	Кол-во
40050	150 x 130 cm	5,6 m	10
40052	150 x 180 cm	6,6 m	10
40054	150 x 90 cm	4,8 m	10
40056	220 x 75 cm 2 бр.	5,8 m	10



МРЕЖА ПРОТИВ НАСЕКОМИ, СИВА



№	Размери	Дължина	Кол-во
40051	150 x 130 cm	5,6 m	10
40053	150 x 180 cm	6,6 m	10
40055	150 x 90 cm	4,8 m	10



МРЕЖА ПРОТИВ НАСЕКОМИ, ЧЕРНА



№	Размери	Дължина	Кол-во
40057	150 x 130 cm	5,6 m	10
40058	150 x 180 cm	6,6 m	10
40059	150 x 90 cm	4,8 m	10



ВЕЛКРО ЗА МРЕЖИ ЗА ПРОЗОРЦИ

№	Размери	Кол-во
40060	9 mm 7 m	1

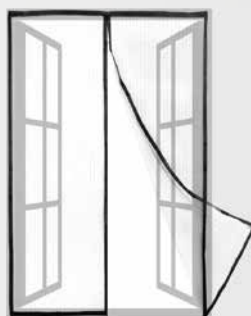

ПЕРДЕ ЗА ВРАТА ПРОТИВ НАСЕКОМИ МАГНИТЕН – АНТРАЦИТ



№	Размери	Кол-во
40077	100 x 220 cm	1



ЗАВЕСА ПРОТИВ НАСЕКОМИ

· Вариращ размер 60 – 120 cm

№	Размери	Цвят	Кол-во
40075	4 x 35 x 220 cm	Бяла	20
40076	4 x 35 x 220 cm	Черна	20

МРЕЖА ЗА ОГРАДА, ПОЦИНКОВАНА, НЕХ



Zn

№	Размери	Кол-во
42150	13 0,7 x 1000 mm - 50 m	1
42151	16 0,7 x 1000 mm - 50 m	1
42152	20 0,7 x 1000 mm - 50 m	1
42153	25 0,8 x 1000 mm - 50 m	1

МРЕЖА ЗА ОГРАДА, ПОЦИНКОВАНА, НЕХ

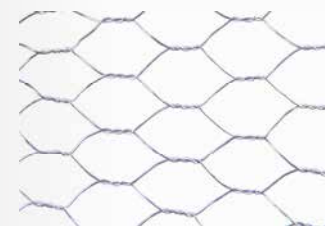

Zn

№	Размери	Кол-во
42155	13 0,7 x 1000 mm - 50 m	1
42156	16 0,7 x 1000 mm - 50 m	1
42157	20 0,7 x 1000 mm - 50 m	1
42158	25 0,8 x 1000 mm - 50 m	1

МРЕЖА ЗА ОГРАДА С PVC ПОКРИТИЕ, НЕХ



Zn

№	Размери	Кол-во
42160	13 1 x 1000 mm - 25 m	1
42161	16 1 x 1000 mm - 25 m	1
42162	20 1 x 1000 mm - 25 m	1
42163	25 1 x 1000 mm - 25 m	1

ГРАДИНСКА ОГРАДА С PVC ПОКРИТИЕ



№	Око	Ø тел	височина	дължина	Кол-во
42175	15 x 9 mm	2 mm	40 cm	25 m	1
42176	15 x 9 mm	2 mm	65 cm	25 m	1
42177	15 x 9 mm	2 mm	90 cm	25 m	1
42178	15 x 9 mm	2 mm	120 cm	25 m	1
42179	15 x 9 mm	2 mm	25 cm	25 m	1



МРЕЖА ЗА ОГРАДА, ПОЦИНКОВАНА, ПРАВОЪГЪЛНИ ОТВОРИ

140
g/m²

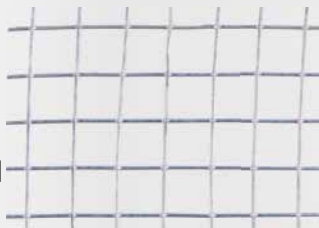

№	Размери	1	№	Размери	1
42185	6 0,65 x 1000 mm - 25 m	1	42174	25 1,4 x 1000 mm - 25 m	1
42170	10 0,8 x 100 mm - 25 m	1	42186	13 1,05 x 1000 mm - 25 m	1
42171	13 0,8 x 1000 mm - 25 m	1	42187	25 2,0 x 1000 mm - 25 m	1
42172	16 1,2 x 1000 mm - 25 m	1	42188	50 2,0 x 1000 mm - 25 m	1
42173	19 1,4 x 1000 mm - 25 m	1			

МРЕЖА ЗА ОГРАДА С PVC ПОКРИТИЕ

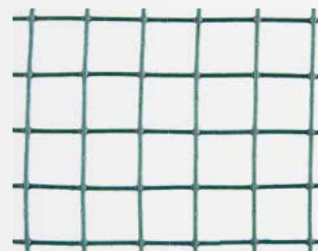

№	Размери	1
42180	13 1,2 x 1000 mm - 25 m	1
42181	16 1,2 x 1000 mm - 25 m	1
42182	25 2,3 x 1000 mm - 25 m	1

МРЕЖА ПРОТИВ ПТИЦИ



№	Размери	1
45570	2 x 5 m 18 x 18 mm	45
45571	2 x 10 m 18 x 18 mm	28
45572	4 x 5 m 18 x 18 mm	24
45573	4 x 10 m 18 x 18 mm	15

ОГРАДА ЗА СИГУРНОСТ

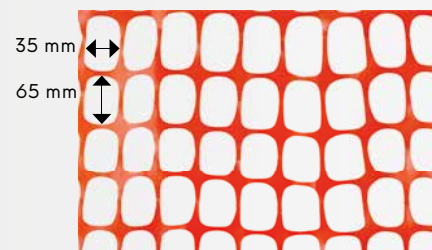

140
g/m²



№	Размери	1
42190	1,2 x 50 m HDPE 140g/m ²	1

МРЕЖА ЗА ОГРАДА



№	Размери	1
42312	1 m 50 bm, 16 x 16 mm	1

МРЕЖА ЗА ДРЪВЧЕТА

Самозаклучваща

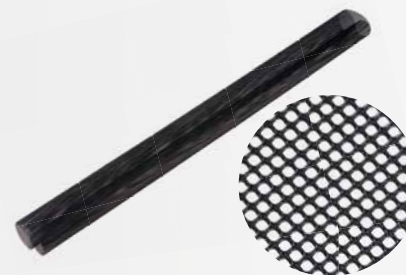

3x
MADE IN EU

№	Размери	1
45580	Ø 11 x 80 cm	1



ТЕЛ

Zn

№	Ø тел	Дължина на тел	
42203	0,6 mm	30 m	50



ТЕЛ

№	Ø тел	Дължина на тел	Покритие	
42201	0,6 mm	30 m	PVC	50
42202	0,9 mm	30 m	PVC	50



БОДЛИВА ТЕЛ, ПОЦИНКОВАНА

Zn

№	Ø тел	Дължина на тел	
42260	1,7 mm	50 m	1
42261	1,7 mm	100 m	1



ИНСТРУМЕНТ ЗА ОБТЯГАНЕ

№	Размери	
50035	2 t	6
50036	4 t	4



ОБТЕГАЧ ЗА ТЕЛ

Zn

№	Размери	
50030	Малък, поцинкован	50
50032	Малък, с PVC покритие	50

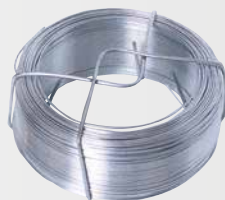

ТЕЛ, ПОЦИНКОВАНА

Zn

№	Ø тел	Дължина на тел	
42207	0,8 mm	50 m	40
42208	0,8 mm	100 m	20
42209	0,9 mm	100 m	20
42240	1,0 mm	50 m	40
42210	1,0 mm	100 m	20
42211	1,2 mm	50 m	40
42212	1,2 mm	100 m	20
42213	1,4 mm	30 m	40
42214	1,4 mm	50 m	20
42217	1,8 mm	30 m	40
42218	1,8 mm	50 m	20



ТЕЛ, ЗЕЛЕНА, С PVC ПОКРИТИЕ

№	Ø тел	Дължина на тел	
42244	1,4 mm	50 m	20
42248	1,8 mm	50 m	20
42249	2,0 mm	50 m	20



ОБТЕГАЧ ЗА ТЕЛ, НЕРЪЖДАЕМА СТОМАНА

№	Размери	МОQ	
50040	Зелен	50	50
50041	Черен	50	50



ОБТЕГАЧ ЗА ТЕЛ

Zn

№	Размери	
50031	Голям, поцинкован	50
50033	Голям, PVC покритие	50



ТЕЛ, ПОЦИНКОВАНА

Zn

№	Ø тел	Дължина на тел	
42219	2,0 mm	26 m	20
42220	2,0 mm	52 m	20
42221	2,0 mm	78 m	20
42228	3,15 mm	26 m	10
42229	3,15 mm	52 m	10
42230	3,15 mm	78 m	10



ТЕЛ, ЗЕЛЕНА, С PVC ПОКРИТИЕ

№	Ø тел	Дължина на тел	
42251	2,6 mm	26 m	20
42252	2,6 mm	52 m	20
42253	2,6 mm	78 m	20
42255	3,4 mm	26 m	10
42256	3,4 mm	52 m	10
42257	3,4 mm	78 m	10



ОБТЕГАЧ ЗА ТЕЛ

№	Размери	
50042	10x	10



ОБТЕГАЧ ЗА ТЕЛ

Zn

№	Размери	
50037	Малък, поцинкован	50
50038	Малък, с PVC покритие	50

МОНТАЖНА КОТВА

Zn

№	Размери	thickness	
55436	70 x 75 mm	110 mm	4 mm 10
55437	80 x 90 mm	130 mm	4 mm 10



МОНТАЖНА КОТВА

Zn

№	Размери	thickness	
55429	70 x 60 mm	100 mm	4 mm 10
55433	81 x 60 mm	100 mm	4 mm 10
55430	91 x 60 mm	100 mm	4 mm 10
55431	101 x 60 mm	100 mm	4 mm 10
55432	121 x 60 mm	100 mm	4 mm 10



РЕГУЛИРУЕМ КРАК ЗА ЗАКРЕПВАНЕ НА КОЛОНА

Zn

№	Размери	thickness	
55465	80 - 160 x 70 mm	100 mm	4 mm 1

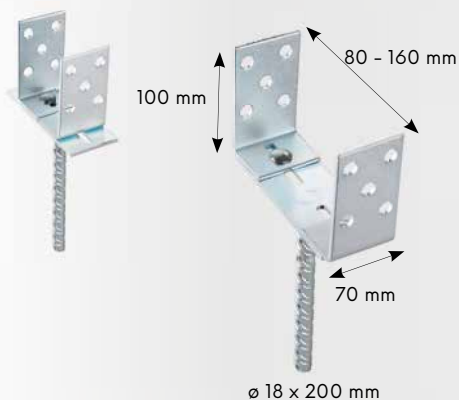

МОНТАЖНА КОТВА

Zn

№	Ø диаметър	Дължина	Дебелина	
55420	71 x 71 mm	150 mm	2 mm	1
55425	81 x 81 mm	150 mm	2 mm	1
55421	91 x 91 mm	150 mm	2 mm	1
55422	101 x 101 mm	150 mm	2 mm	1
55423	121 x 121 mm	150 mm	2 mm	1
55424	151 x 151 mm	150 mm	2 mm	1



АНКЕР С РЕГУЛИРУЕМ ВИНТ

Zn

№	Ø диаметър	височина диаметър	Резба	
55460	80 x 80 mm	150 mm	M16	10
55461	100 x 100 mm	150 mm	M16	10
55462	150 x 150 mm	150 mm	M24	10



СВРЕДЕЛ ЗА ПРОБИВАНЕ

№	Ø	A	B	
61299	110 mm	270 mm	1200 mm	1
61300	140 mm	270 mm	1200 mm	1
61301	170 mm	270 mm	1200 mm	1
61302	200 mm	270 mm	1200 mm	1



МОНТАЖНА КОТВА

Zn

№	Ø диаметър	Дължина	Дебелина	
55400	71 x 71 mm	750 mm	2 mm	1
55401	91 x 91 mm	750 mm	2 mm	1
55406	81 x 81 mm	750 mm	2 mm	1
55402	91 x 91 mm	900 mm	2 mm	1
55403	101 x 101 mm	900 mm	2 mm	1
55404	121 x 121 mm	900 mm	2 mm	1
55405	151 x 151 mm	900 mm	2 mm	1



МОНТАЖНА КОТВА, U-ОБРАЗНА

Zn

№	Ø диаметър	Дължина	Дебелина	
55455	71 x 60 mm	100 mm	4 mm	1
55452	81 x 60 mm	100 mm	4 mm	1
55456	90 x 60 mm	100 mm	4 mm	1
55453	101 x 60 mm	100 mm	4 mm	1
55457	110 x 60 mm	100 mm	4 mm	1
55454	121 x 60 mm	100 mm	4 mm	1

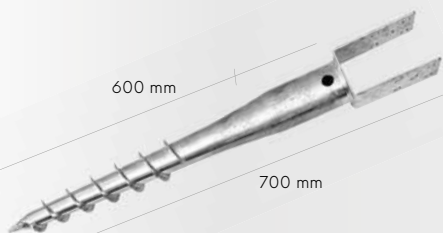

СВРЕДЕЛ ЗА ПРОБИВАНЕ

· Редукция

Ø 24 mm
 Ø 35 mm
 Ø 40 mm
 Ø 48 mm
 Ø 55 mm

Zn 6x

№	Ø диаметър	Дължина	Размери	
55450	60 mm	550 mm	1 бр. 5x Редукция	8



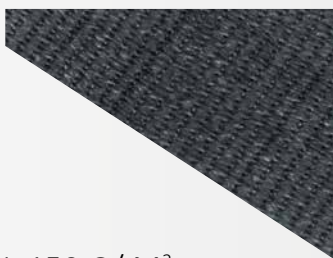

**СЕННИК, 150 G/ M²
АНТРАЦИТ**

· Сянка 85%



№	Размери	
45496	1 x 10 m	1
45497	1,5 x 10 m	1
45498	1,8 x 10 m	1
45499	2 x 10 m	1

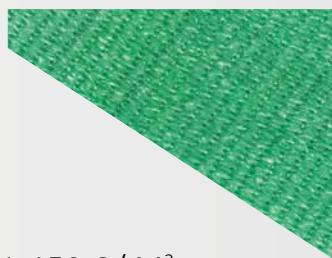

СЕННИК, 150 G/ M²

· Сянка 85%



№	Размери	
45460	1 x 10 m	1
45461	1,5 x 10 m	1
45463	1,8 x 10 m	1
45462	2 x 10 m	1



СЕННИК, 220 G/ M²

· Сянка 95%



№	Размери	
45465	1 x 10 m	1
45466	1,5 x 10 m	1
45467	2 x 10 m	1

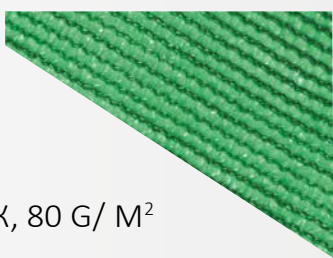

СЕННИК, 80 G/ M²



№	Размери	
45450	1 x 10 m	1
45451	1,5 x 10 m	1
45453	1,8 x 10 m	1
45452	2 x 10 m	1

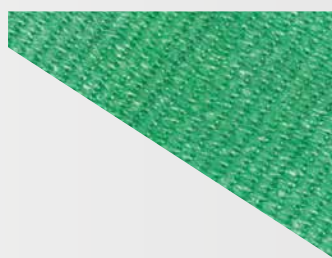

СЕННИК, 150 G/ M²

· Сянка 85%

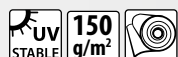

№	Размери	
45480	1,5 x 50 m	1

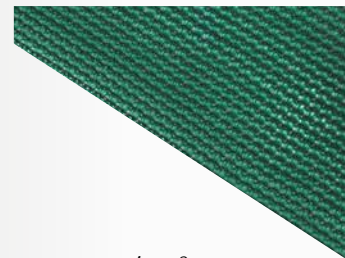

СЕННИК, 220 G/ M²

· Сянка 95%



№	Размери	
45485	1,5 x 50 m	1



КАБЕЛНИ СТЯЖКИ

· EN 50146
· nylon



№	Характеристики	
23875	120 mm 4,8 mm	1



**ОБТЕГАЧ
ЗА СЕННИК**



№	Размери	
45470		1





КОМПЛЕКТ ПРИБОРИ ЗА ГРИЛ, 18 ЧАСТИ

INOX 18x



№ 43077 Размери

6



КОМПЛЕКТ ПРИБОРИ ЗА ГРИЛ, 3 ЧАСТИ

INOX 3x



№ 43071 Размери 380 mm

16



ЩИПЦИ ЗА ГРИЛ

INOX



№ 43072 Размери 360 mm

25



ПОДНОС ЗА ГРИЛ

4x

№ 43050 Размери 300 x 200 mm

50



ДВОЙНА СКАРА, ПРАВОЪГЪЛНА

№ 43084 Размери 330 x 290 mm

50

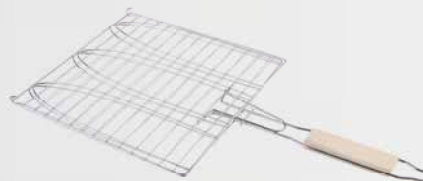

СКАРА ЗА РИБА

№ 43082 Размери 280 x 276 mm

50

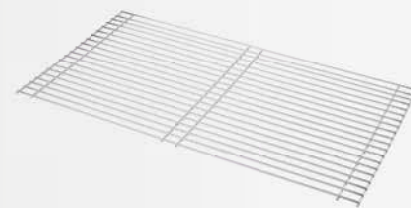

СКАРА, ПРАВОЪГЪЛНА

№ 43058 58 x 30 mm
№ 43060 60 x 40 mm
№ 43068 68 x 40 mm20
20
16

СКАРА ЗА РИБА

№ 43083 Размери 360 x 130 mm

12



ШИШЧЕТА ЗА ГРИЛ

4x

№ 43086 Размери Ø 3 x 380 mm

80



ВИЛИЦА ЗА ГРИЛ

· Със санитарен сертификат

№ 43097 Размери 100 cm

100



285 - 900 mm

ВИЛИЦА ЗА ГРИЛ - ТЕЛЕСКОПИЧНА



№ 43094
Размери

1



ДУХАЛО ЗА ГРИЛ



№ 43087
Размери

1



ЧЕТКА ЗА ГРИЛ

№ 43098
Размери 30 cm

10



ЧЕТКА ЗА ГРИЛ, 3 В 1

№ 43099
Размери

40



ГРИЛ МОТОР, 230 V



№ 43090
Размери

24



ГРИЛ МОТОР, НА БАТЕРИИ

- батерия тип D



№ 43089
Размери

48



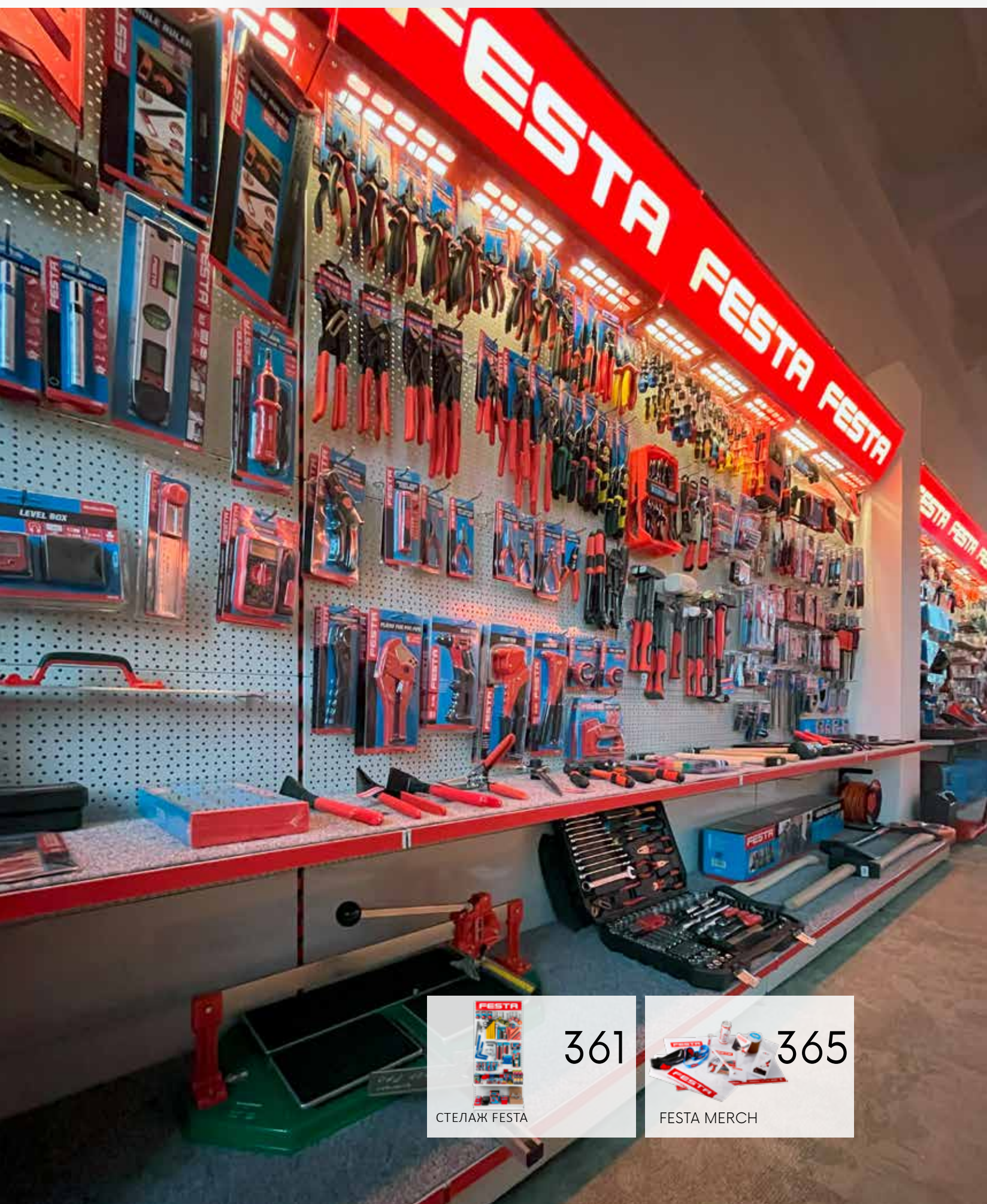

361

СТЕЛАЖ FESTA



365

FESTA MERCH



 СТЕЛАЖ FESTA С АРТИКУЛИ

FESTA

СВЕТЕЩА КУТИЯ ЗА ФЕСТА СТЕЛАЖ 81011

№	Характеристики	
81195	FESTA POWER TOOLS	1
81196	FESTA	1
81197	FESTA INDUSTRY	1



СТЕЛАЖ FESTA + АКЕСОАРИ



№	Характеристики	
81011	Стелаж FESTA CZ 200 x 100 cm	1
81011A	Стелаж 81011 + стикер AQUATIC	1
81011F	Стелаж 81011 + стикер FESTA CZ	1
81011G	Стелаж 81011 + стикер FESTA GB	1
81011H	Стелаж 81011 + стикер FESTA SK	1
81011R	Стелаж 81011 + стикер ROSA	1
81012	Рафт, бял CZ Дълбочина 40 cm	8
81013	Кука 10 cm	10
81014	Кука 16 cm	10
81015	Кука 20 cm	10
81035	Кука 20 cm	10
81016	Кука 30 cm	10
81036	Кука 30 cm	10
81022	Телен кош, голям, 50 cm	1
81023	Телен кош, малък, 40 cm	1
81024	Преграда, голяма, 50 cm	1
81025	Преграда, малка, 40 cm	1

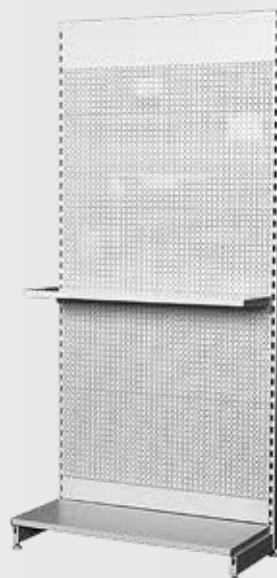

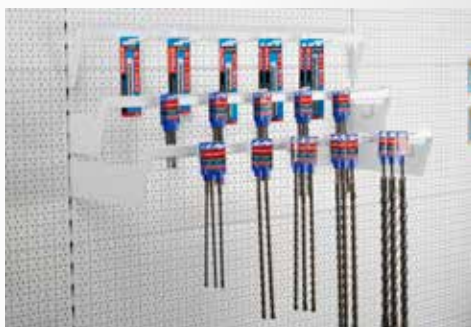

КОНЗОЛА

· Съвместима със стелаж FESTA

№	Характеристики	
81150	1000 × 50 × 135 mm	1
81151	1000 × 150 × 135 mm	1
81152	1000 × 350 × 135 mm	1

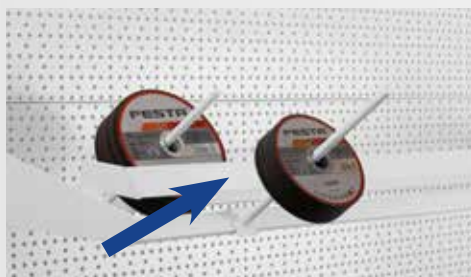

ПОСТАВКА ЗА ЦЕНИ

· Съвместима със стелаж FESTA

№	Характеристики	
81155	1000 × 80 × 100 mm	1

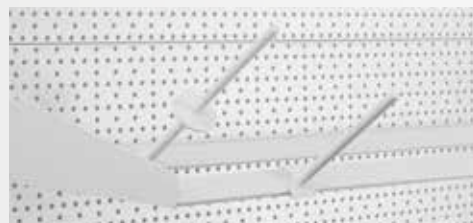

КУКА ЗА ПОСТАВЯНЕ НА ДИСКОВЕ

· Съвместима със стелаж FESTA

№	Характеристики	
81186	150 mm	1
81185	250 mm	1



ПОСТАВКА ЗА ДИСКОВЕ

· Съвместима със стелаж FESTA

№	Характеристики	
81170	1000 × 450 × 85 mm	1



ПОСТАВКА ЗА ТРИОНИ

· Съвместима със стелаж FESTA

№	Характеристики	
81190		1



КУКА ЗА АКУ

· Съвместима със стелаж FESTA

№	Характеристики	
81189		1



ЛАВИЦА ЗА ДИСКОВЕ

· Съвместима със стелаж FESTA

№	Характеристики	
81191	220 × 220 × 200 mm	1

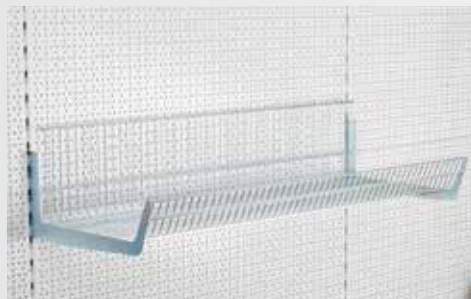

ТЕЛЕН КОШ

· Съвместима със стелаж FESTA

№	Характеристики	
81160	1000 × 470 × 180 mm	1



РАЗДЕЛИТЕЛ

· Съвместима със стелаж FESTA

№	Характеристики	
81165	470 × 180 mm	1



ДЪРЖАЧ ЗА ЧУКОВЕ

Zn

· Съвместима със стелаж FESTA

№	Характеристики	
81188	max 2 kg	1



ДВОЙНА КУКА ЗА КОНЗОЛА

· Съвместима със стелаж FESTA

№	Характеристики	
81175	120 mm	1
81178	180 mm	1

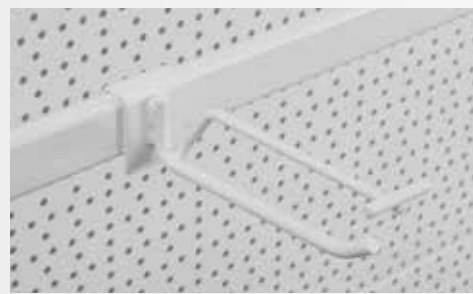

ЕДИНИЧНА КУКА ЗА КОНЗОЛА

· Съвместима със стелаж FESTA

№	Характеристики	
81180	120 mm	1



№	Характеристики	
81200	Стенна 40/2400 mm котвена	1
81201	Стенна 80/1108 mm	1
81202	Стенна 80/1208 mm	1
81203	Стенна 80/1408 mm	1
81204	Стенна 80/1608 mm	1
81205	Стенна 80/1808 mm	1
81206	Стенна 80/2000 mm	1
81207	Стенна 80/2108 mm	1
81208	Стенна 80/2208 mm	1
81209	Стенна 80/2308 mm	1
81210	Стенна 80/2408 mm	1
81211	Стенна 80/2600 mm	1
81212	Стенна 60/1000 mm	1
81213	Стенна 60/1208 mm	1
81214	Стенна 60/1408 mm	1
81215	Стенна 60/1608 mm	1
81216	Стенна 60/1808 mm	1
81217	Стенна 60/2108 mm	1
81218	Стенна 60/2208 mm	1
81225	Стенна 30/2108 mm предна	1
81486	Стенна 60/2000 mm	1
81219	Стенно разширение 80x30/100mm	1
81220	Стенно разширение 80x30/400 mm	1
81221	Стенно разширение 80x30/600 mm	1
81222	Стенно разширение 60x30/400 mm	1
81223	Ъглово разширение 90° 2100mm	1
81224	Ъглово разширение 90° 2200mm	1
81226	Подпора 80	1
81227	Подпора 60	1
81228	Гондола връзка с рафт 80	1
81229	Държач	1
81230	Кука	1
81231	Кука	1
81232	Държач връх	1
81233	Пълнеж 400	1
81234	Пълнеж 500	1
81235	Пълнеж 600	1
81236	Пълнеж 700	1
81237	Пълнеж 800	1
81238	Ниска конзола 200	1
81239	Ниска конзола 300	1
81240	Ниска конзола 400	1
81241	Ниска конзола 500	1
81242	Висока конзола 400	1
81243	Висока конзола 500	1
81244	Висока конзола 600	1
81245	Висока конзола 700	1
81246	Ниска конзола 300 двойна	1
81247	Ниска конзола 400 двойна	1
81248	Ниска конзола 300 двойна	1
81251	Конзола RR 80	1
81249	Висока конзола двойна 500	1
81250	Носач за витрина 400/2000	1
81252	Делител за витрина	1
81253	Делител, нисък 300 пластмаса	1
81254	Делител, нисък 400 пластмаса	1
81255	Делител, нисък 500 пластмаса	1
81256	Делител, нисък 300 стъкло	1
81257	Делител, нисък 400 стъкло	1
81258	Делител, нисък 500 стъкло	1
81259	Делител, висок 300 стъкло	1
81262	Делител, висок 300 пластмаса	1
81263	Делител, висок 400 пластмаса	1
81264	Делител, висок 500 пластмаса	1
81260	Делител, висок 400 стъкло	1
81261	Делител, висок 500 стъкло	1
81265	Страница за витрина 400/2000	1
81266	Страница стряха RR 80	1
81267	Страница 500mm	1
81268	Страница за витрина 500	1
81269	Носач, горен 500	1
81271	Страница рафт, ниска 300 пластмаса	1
81272	Страница рафт, ниска 400 пластмаса	1
81273	Страница рафт, ниска 500 пластмаса	1
81274	Страница висока, стъкло 300/250	1
81275	Странична закопчалка	1
81276	Страница висока, стъкло 500/250	1
81277	Страница висока, стъкло 400	1
81278	Страница висока, стъкло 500	1
81270	Носач за стряха RR 80	1
81279	Носач за стряха	1
81280	Странична стряха, лява	1
81281	Странична стряха, дясна	1
81282	Странично рамо	1
81284	Рамо, двойно 400/10	1
81285	Рамо, двойно 300/8	1
81286	Рамо, опростено 350	1
81287	Рамо, опростено 500	1
81288	Рамо, опростено 250	1
81289	Кука, двойна 100	1
81290	Кука, двойна 200	1
81291	Кука, двойна 300	1
81292	Кука 130 V	1

№	Характеристики	
81293	Кука, опростена 100	1
81294	Кука, опростена 200	1
81295	Кука, опростена 300	1
81296	Кука 200	1
81297	Кука 300	1
81298	Патрон за витрина	1
81299	Разделителна мрежа 360mm Висока	1
81300	Разделителна мрежа 460 mm Висока	1
81301	Разделителна мрежа 560 mm Висока	1
81302	Разделителна мрежа 560 mm Ниска	1
81303	Конзола 300 двойна L	1
81304	Конзола 300 двойна P	1
81305	Конзола 400 двойна L	1
81306	Конзола 400 двойна P	1
81307	Конзола 500 двойна L	1
81308	Конзола 500 двойна P	1
81309	Полица, полукръгла 300	1
81310	Полица, полукръгла 400	1
81311	Полица, полукръгла 500	1
81312	Цокъл полукръгъл 500	1
81313	Чело на цокъл, полукръгло 500	1
81314	Поставка за цени 300 полукръгла	1
81315	Поставка за цени 400 полукръгла	1
81316	Поставка за цени 500 полукръгла	1
81317	Полица полукръгла 600	1
81318	Цокъл полукръгъл 600	1
81319	Чело на цокъл, полукръгло 600	1
81320	Подложка за цена P 7,5x5 cm	1
81321	Подложка за цена P 2,6x3,2 cm	1
81322	Подложка за цена P 5,0x4,0 cm	1
81323	Полица с отвори 500/1000	1
81324	Спойка планка 80, modul 1	1
81325	Заден панел 10x100cm	1
81326	Заден панел 20x100cm	1
81327	Заден панел 40x100cm	1
81328	Заден панел с отвори 20x100 cm EUR	1
81329	Заден панел с отвори 40x100 cm EUR	1
81330	Капак за гондола 8x100cm	1
81331	Капак за гондола 6x100cm	1
81332	Носач 100cm	1
81333	Полица стъклена 985/300	1
81334	Полица стъклена 985/400	1
81335	Полица дървена 47/98,5	1
81336	Полица тел 1000/500	1
81337	Полица вдлъбната 1000x500	1
81338	Полица 200/1000	1
81339	Полица 300/1000	1
81340	Полица 400/1000	1
81341	Полица 500/1000	1
81342	Полица 400/1000 RAL7015	1
81343	Полица 500/1000 RAL7015	1
81347	Висока витрина 1000/400	1
81348	Стъкло за висока витрина 1000/400	1
81349	Вложка за рафтове	1
81350	Таван за метална лавица 500/100	1
81352	Подпора висока 1000 mm, стъкло	1
81353	Подпора висока, пластмаса	1
81354	Чело 1000 mm, пластмаса	1
81355	Ценова листа, 1000mm	1
81356	Таван,	1
81351	Таван за висок делител, 1000	1
81357	Таван, 1000 mm	1
81403	Таван за висок делител, 1250 mm	1
81420	Таван за висок делител, 625 mm	1
81358	Двоен жлеб	1
81359	Поставка за цени, 1000mm	1
81360	Отворена витрина 1000/2000	1
81361	Чело 1000mm	1
81362	Покривна плоча 1000mm	1
81363	Отворена витрина	1
81364	Витрина с плъзгаща се врата	1
81365	Огледало за витрина	1
81366	Рамка с панти, modul 1	1
81367	Кука	1
81370	Телена кошница	1
81371	Плот 1000mm	1
81372	Стряха SU 5 1000mm	1
81373	Полица стъкло 1000mm	1
81374	Полица, неръждаема стомана 1000mm	1
81375	Полица 600mm	1
81376	Полица 600mm	1
81377	Полица стъкло 600mm	1
81378	Полица 1000mm	1
81379	Полица, малка	1
81380	Плот, висок 90°	1
81381	Плот, двоен 1000mm	1
81382	Плъзгаща се врата 1000mm	1
81383	Чекмедже	1
81384	Полица тел RDE 1000/360mm	1
81385	Полица тел RDE 1000/460mm	1
81386	Полица тел RDE 1000/560mm	1
81387	Ценова листа RDE 1000 mm	1
81388	Заден панел 100/1250mm	1

№	Характеристики	
81389	Заден панел 200/1250mm	1
81390	Заден панел 400/1250mm	1
81391	Заден панел 200/1250mm с отвори	1
81393	Капак за гондолау 80/1250mm	1
81392	Заден панел 400/1250mm с отвори	1
81394	Капак за гондолау 60/1250mm	1
81395	Носач стряха 1250mm	1
81396	Полица 200/1250mm	1
81439	Носач стряха 1000 mm	1
81344	Полица 300/1000 подсилена	1
81345	Полица 400/1000 подсилена	1
81346	Полица 500/1000 подсилена	1
81397	Полица 300/1250mm	1
81400	Полица 300/1250mm, подсилена	1
81401	Полица 400/1250mm, подсилена	1
81402	Полица 500/1250mm, подсилена	1
81398	Полица 400/1250mm	1
81399	Полица 500/1250mm	1
81404	Чело 1250mm, пластмаса	1
81405	Ценова листа, 1250mm	1
81406	Таван 1250mm	1
81407	Поставка за цени, 1250mm	1
81408	Чело, 1250mm	1
81409	Покривна плоча, 600x1250mm	1
81410	Заден панел 100/625	1
81411	Заден панел 200/625	1
81412	Заден панел 400/625	1
81413	Заден панел 400/625 с отвори	1
81414	Капак за гондола 80/650	1
81415	Капак за гондола 60/650	1
81416	Носач стряха, modul 3	1
81432	Носач стряха, 1330mm	1
81417	Полица 300/625	1
81418	Полица 400/625	1
81419	Полица 500/625	1
81421	Чело 625, пластмаса	1
81422	Ценова листа 625mm	1
81423	Таван 625mm	1
81424	Поставка за цени, 625mm	1
81425	Заден панел 100/1330	1
81457	Чело 200 пластмаса	1
81426	Заден панел 200/1330	1
81427	Заден панел 400/1330	1
81428	Заден панел 200/1330 с отвори S	1
81429	Заден панел 400/1330 с отвори S	1
81430	Капак за гондола 80/1330	1
81431	Капак за гондола 60/1330	1
81433	Полица 300/1330	1
81434	Полица 400/1330	1
81435	Полица 500/1330	1
81436	Ценова листа, 1330 mm	1
81437	Таван 1330 mm	1
81438	Поставка за цени 1330 mm	1
81440	Лавица, тел	1
81441	Заден панел 100 ъглова	1
81442	Заден панел 400 ъглова	1
81443	Цокъл 500/1000mm	1
81444	Цокъл 600 mm	1
81445	Заден панел ъглов 400mm с отвори	1
81447	Полица 300 ъглова	1
81448	Полица 400 ъглова	1
81449	Полица 500 ъглова	1
81450	Полица 600 ъглова	1
81451	Поставка за цени 300 ъглов	1
81452	Поставка за цени 400 ъглов	1
81453	Поставка за цени 500 ъглов	1
81454	Ценова листа 300 ъглов	1
81455	Ценова листа 400 ъглов	1
81456	Ценова листа 500 ъглов	1
81458	Лавица, тел U 1000/400	1
81459	Лавица, тел U 1000/500	1
81460	Ъглов цокъл 90°	1
81461	Заден панел, ъглов 100, стенна 60	1
81462	Заден панел, ъглов 200, стенна 60	1
81463	Заден панел, ъглов 400, стенна 80	1
81466	Заден панел, ъглов 100, стенна 80	1
81467	Заден панел, ъглов 400, стенна 60	1
81468	Лавица, ъглова 90° 400mm	1
81469	Лавица, ъглова 90° 500mm	1
81470	Поставка за цени ъглова 90° 400mm	1
81471	Поставка за цени ъглова 90° 500mm	1
81472	Ценова листа ъглова 90° 400mm	1
81473	Ценова листа ъглова 90° 500mm	1



ЪГЛОВА КОНЗОЛА, БЯЛА

MOQ
2

№	Характеристики	
81100	100 x 75 mm	24
81101	125 x 100 mm	24
81102	150 x 125 mm	24
81103	200 x 150 mm	24
81104	250 x 200 mm	24
81105	300 x 250 mm	24
81106	350 x 300 mm	24



СТЕННА ЗА СТЕЛАЖ

№	Характеристики	
81053	50 cm	10
81054	80 cm	10
81057	200 cm	10



ЕДИНИЧНА КОНЗОЛА ЗА СТЕЛАЖ

№	Характеристики	
81070	10 cm	10
81071	15 cm	10
81077	50 cm	10



ПОСТАВКА ЗА ХАРТИЯ LEVELING SYSTEMS



№	Характеристики	
37179	60 x 40 x 175 cm - ENG	1



ПОСТАВКА ЗА ХАРТИЯ FESTA



№	Характеристики	
81602	60 x 40 x 175 cm - ENG	1

ПОСТАВКА ЗА ХАРТИЯ FESTA POWER TOOLS



№	Характеристики	
81603	60 x 40 x 175 cm	1



FESTA

РЕКЛАМНА ТЕНИСКА ЧЕРВЕНА

№	Характеристики	
M90203	M	1
M90204	L	1
M90205	XL	1
M90206	XXL	1
M90207	XXXL	1

FESTA

РЕКЛАМЕН БЛОК

№	Характеристики	
M90400		1



FESTA

РЕКЛАМНА ХИМИКАЛКА

№	Характеристики	
M90403		1

FESTA

РЕКЛАМНИ ЧОРАПИ

№	Характеристики	
M90220	39-41	1
M90221	42-44	1
M90222	45-47	1



FESTA

РЕКЛАМЕН USB КАБЕЛ

№	Характеристики	
M90519		1

FESTA

РЕКЛАМНА КАПАЧКА

№	Характеристики	
M90210		1



FESTA

РЕКЛАМЕН МЕТЪР

№	Характеристики	
11410	2 m x 16 mm	1



FESTA

РЕКЛАМЕН СГЪВАЕМ НОЖ

№	Характеристики	
16209		1



Арт. номер	Стр.	Арт. номер	Стр.	Арт. номер	Стр.	Арт. номер	Стр.	Арт. номер	Стр.	Арт. номер	Стр.
10002	96	11355	98	13249	121	13414	101	13509	99	14420	104
10003	96	11356	98	13250	121	13415	101	13510	99	14421	104
10005	96	11358	98	13251	121	13416	101	13511	99	14425	105
10008	96	11360	98	13252	121	13417	101	13512	99	14430	105
10025	96	11410	100	13253	121	13418	101	13513	99	14435	105
10033	96	11410	365	13254	121	13419	101	13514	99	14440	105
10035	96	11416	99	13255	121	13420	101	13515	99	14445	105
10043	96	11420	100	13256	121	13421	101	13516	99	14446	105
10045	96	11425	100	13257	121	13422	101	13517	99	14450	105
10048	96	11444	100	13258	121	13423	101	13518	99	14451	105
10110	96	11445	100	13259	121	13424	101	13519	99	14455	105
10120	96	12010	99	13260	120	13425	101	13520	99	14456	105
10130	96	12020	99	13261	117	13426	101	13521	99	14457	105
10330	96	12030	99	13262	117	13427	101	13522	99	14458	105
10332	96	12050	99	13263	117	13428	101	13523	99	14471	105
10334	96	12110	99	13264	116	13429	101	13524	99	14472	105
10336	96	12120	99	13265	116	13430	101	13525	99	14473	105
10430	97	12130	99	13266	116	13431	101	13526	99	14474	105
10450	97	12150	99	13267	117	13432	101	13527	99	14480	104
10490	97	12220	99	13268	116	13433	101	13528	99	14485	109
10996	97	12230	99	13269	116	13434	101	13529	99	14485	271
10998	97	12250	99	13270	116	13435	101	13530	99	14486	109
10999	97	12433	100	13271	116	13436	101	13531	99	14486	271
11002	99	12435	100	13272	116	13437	101	13532	99	14490	105
11003	99	13010	101	13273	116	13438	101	13533	99	14491	105
11005	99	13020	101	13274	116	13439	101	13534	99	14492	105
11006	99	13021	101	13275	116	13440	101	14001	102	14493	105
11007	99	13022	101	13276	117	13441	101	14002	102	14494	105
11008	99	13023	101	13277	120	13442	101	14003	102	15003	107
11082	99	13111	101	13278	116	13443	101	14004	102	15004	107
11083	99	13120	101	13279	117	13444	101	14006	102	15005	107
11085	99	13200	118	13280	117	13445	101	14007	102	15006	107
11102	98	13201	118	13281	102	13446	101	14008	102	15008	107
11103	98	13202	118	13282	102	13447	101	14009	102	15010	107
11105	98	13205	119	13284	117	13448	101	14010	103	15012	107
11106	98	13206	119	13285	102	13449	101	14011	103	15015	107
11107	98	13207	119	13288	117	13450	101	14012	103	15018	107
11110	98	13208	119	13290	217	13451	101	14013	102	15020	107
11200	99	13211	101	13293	217	13452	101	14015	103	15033	106
11201	99	13212	119	13294	217	13453	101	14017	103	15034	106
11202	99	13214	118	13295	120	13454	101	14019	103	15035	106
11204	99	13216	118	13296	120	13455	101	14025	105	15036	106
11205	99	13217	118	13350	121	13456	101	14030	103	15037	106
11206	99	13218	118	13351	121	13457	101	14035	102	15039	106
11207	99	13219	118	13352	121	13458	101	14040	102	15103	107
11208	99	13220	101	13353	121	13459	101	14045	102	15104	107
11209	99	13222	118	13354	121	13460	101	14060	103	15105	107
11210	99	13223	118	13355	121	13461	101	14070	103	15106	107
11220	98	13224	118	13360	121	13462	101	14075	103	15108	107
11221	98	13225	118	13361	121	13463	101	14077	103	15110	107
11226	98	13226	118	13362	121	13464	101	14080	102	15112	107
11239	98	13227	118	13363	121	13465	101	14090	104	15115	107
11259	98	13228	118	13364	121	13466	101	14091	104	15118	107
11260	98	13229	118	13365	121	13467	101	14220	105	15120	107
11311	100	13230	118	13399	101	13468	101	14225	105	15204	107
11312	100	13231	118	13400	101	13469	101	14230	105	15205	107
11313	100	13235	118	13401	101	13470	101	14235	105	15206	107
11314	100	13236	118	13402	101	13471	101	14240	105	15208	107
11323	98	13237	118	13403	101	13472	101	14250	105	15210	107
11325	98	13238	118	13404	101	13473	101	14350	105	15212	107
11327	98	13240	120	13405	101	13500	99	14360	105	15215	107
11333	98	13241	120	13406	101	13501	99	14370	105	15218	107
11335	98	13242	120	13407	101	13502	99	14380	105	15220	107
11337	98	13243	120	13408	101	13503	99	14399	105	15230	107
11338	98	13244	120	13409	101	13504	99	14410	105	15235	108
11343	98	13245	120	13410	101	13505	99	14411	105	15301	109
11345	98	13246	119	13411	101	13506	99	14415	104	15301	271
11347	98	13247	119	13412	101	13507	99	14417	104	15310	108
11353	98	13248	119	13413	101	13508	99	14418	104	15310	270

СПИСЪК С АРТИКУЛИ

Арт. номер	Стр.	Арт. номер	Стр.	Арт. номер	Стр.	Арт. номер	Стр.	Арт. номер	Стр.	Арт. номер	Стр.
15315	108	15810	109	16003	122	16075	130	16300	139	17037	137
15315	270	15810	271	16004	122	16077	130	16301	139	17038	177
15318	108	15812	109	16005	122	16078	130	16303	139	17039	176
15318	270	15812	271	16006	122	16081	130	16304	139	17040	174
15320	108	15815	109	16010	122	16082	129	16305	138	17041	174
15320	270	15815	271	16010	122	16083	131	16306	138	17042	174
15325	108	15818	109	16011	122	16084	131	16307	138	17043	174
15325	270	15818	271	16011	122	16085	126	16308	138	17044	174
15330	108	15820	109	16011	122	16086	126	16309	138	17045	174
15330	270	15820	271	16012	122	16087	127	16310	139	17046	177
15335	108	15825	109	16012	122	16090	125	16310	139	17047	172
15335	270	15825	271	16012	122	16091	125	16311	139	17048	177
15340	108	15830	109	16013	122	16095	127	16311	139	17049	177
15340	270	15830	271	16013	122	16099	124	16311	139	17050	139
15415	108	15850	109	16016	122	16100	124	16312	139	17050	181
15415	270	15850	271	16017	122	16105	124	16312	139	17051	177
15418	108	15853	109	16019	122	16110	124	16315	137	17052	177
15418	270	15853	271	16021	128	16115	124	16315	137	17053	177
15420	108	15855	109	16023	127	16120	124	16319	139	17054	177
15420	270	15855	271	16024	128	16125	124	16320	139	17055	177
15425	108	15860	109	16025	125	16130	126	16321	139	17056	177
15425	270	15860	271	16026	128	16131	124	16321	229	17057	177
15430	108	15870	109	16028	128	16135	126	16401	181	17058	177
15430	270	15870	271	16029	125	16136	125	16405	181	17059	176
15510	108	15880	109	16030	128	16137	125	16406	181	17060	176
15510	270	15880	271	16031	128	16140	126	16407	181	17061	176
15515	108	15885	256	16032	128	16141	128	16408	181	17062	176
15515	270	15886	256	16033	127	16142	125	16420	181	17063	175
15518	108	15886	349	16034	126	16143	125	16500	176	17064	175
15518	270	15887	256	16035	127	16144	125	16501	176	17065	175
15520	108	15887	349	16036	129	16145	125	16502	176	17066	175
15520	270	15888	256	16037	127	16146	125	16990	136	17067	175
15525	108	15888	349	16039	127	16147	126	16990	320	17068	175
15525	270	15889	256	16041	129	16150	125	16991	136	17069	175
15530	108	15893	109	16042	129	16151	125	16991	320	17070	175
15530	270	15893	271	16042	279	16198	131	16998	122	17071	175
15535	108	15894	109	16043	128	16199	131	16999	122	17072	175
15535	270	15894	271	16044	126	16201	132	17001	171	17075	175
15540	108	15895	109	16046	128	16202	173	17002	171	17076	175
15540	270	15895	271	16049	129	16205	173	17003	171	17077	175
15615	108	15904	111	16050	129	16206	173	17004	171	17078	177
15615	270	15906	111	16051	129	16208	173	17005	171	17079	176
15620	108	15908	111	16052	129	16209	133	17006	171	17080	176
15620	270	15910	111	16053	128	16209	365	17007	171	17081	176
15625	108	15912	111	16054	129	16210	132	17008	171	17082	176
15625	270	15915	111	16055	128	16211	132	17009	171	17083	178
15630	108	15920	111	16056	278	16212	132	17010	171	17084	176
15630	270	15954	111	16057	126	16218	133	17011	171	17085	176
15710	109	15956	111	16058	126	16219	133	17012	176	17086	176
15710	270	15958	111	16059	129	16220	133	17013	176	17087	172
15715	109	15960	111	16060	130	16221	133	17014	176	17089	178
15715	270	15962	111	16061	130	16222	133	17015	178	17090	178
15720	109	15965	111	16062	130	16223	133	17016	178	17091	178
15720	270	15970	111	16063	130	16224	134	17017	178	17092	178
15725	109	15980	111	16064	130	16225	132	17019	178	17093	178
15725	270	15981	111	16065	130	16226	134	17020	177	17094	171
15730	109	15983	100	16066	124	16227	134	17021	177	17095	171
15730	270	15985	100	16066	130	16228	134	17022	177	17096	171
15735	109	15988	100	16067	130	16229	132	17023	175	17097	171
15735	270	15989	100	16068	130	16230	132	17024	171	17098	171
15740	109	15990	111	16069	129	16231	132	17025	174	17099	171
15740	270	15991	111	16070	129	16231	135	17026	137	17100	171
15754	110	15992	111	16070	131	16232	134	17027	137	17101	169
15756	110	15993	111	16071	127	16232	174	17028	177	17102	169
15758	110	15996	110	16071	130	16234	132	17029	176	17103	169
15760	110	15997	110	16072	130	16235	133	17033	176	17104	169
15762	110	15998	110	16073	131	16236	133	17034	175	17105	169
15768	110	15999	110	16074	126	16281	127	17035	175	17108	171
15770	110	16002	122	16074	131	16282	127	17036	175	17109	175

Арт. номер	Стр.	Арт. номер	Стр.	Арт. номер	Стр.	Арт. номер	Стр.	Арт. номер	Стр.	Арт. номер	Стр.
17110	171	17238	156	17393	160	17528	165	17622	164	17831	159
17111	179	17240	158	17394	160	17532	166	17623	164	17832	159
17112	179	17241	158	17395	160	17533	166	17624	164	17835	159
17113	179	17242	158	17396	160	17534	166	17625	164	17836	159
17116	179	17243	158	17397	160	17539	165	17626	164	17837	159
17117	179	17244	158	17398	160	17548	164	17628	164	17838	159
17121	179	17245	155	17400	161	17549	164	17629	164	17839	159
17122	179	17247	153	17401	160	17550	164	17630	164	17840	159
17125	172	17250	161	17402	160	17551	164	17631	164	17841	159
17126	172	17255	161	17405	160	17552	164	17632	164	17842	159
17127	172	17259	153	17406	160	17553	164	17633	164	17843	159
17128	172	17260	153	17407	160	17554	164	17640	166	17844	159
17130	172	17261	167	17410	160	17555	164	17642	166	17845	159
17133	172	17262	167	17411	160	17556	164	17643	166	17846	159
17135	172	17292	158	17412	160	17557	164	17644	166	17847	159
17137	172	17294	158	17413	160	17558	164	17645	166	17848	159
17138	172	17295	158	17414	160	17559	164	17650	166	17849	159
17140	169	17296	158	17415	160	17560	164	17651	166	17850	159
17142	169	17297	158	17416	160	17561	164	17652	166	17851	159
17145	169	17298	158	17420	160	17562	164	17653	166	17852	159
17146	169	17299	158	17421	160	17563	164	17654	166	17853	159
17148	169	17300	178	17422	160	17564	164	17655	166	17854	159
17150	175	17301	178	17427	161	17565	164	17656	166	17855	159
17151	175	17302	178	17450	167	17566	164	17657	166	17856	159
17158	181	17303	178	17451	167	17567	164	17658	166	17860	159
17159	181	17304	178	17452	167	17568	164	17659	166	17861	159
17160	181	17305	178	17454	168	17569	164	17660	164	17862	159
17165	179	17306	178	17455	161	17570	164	17661	164	17863	159
17167	179	17308	159	17455	168	17571	164	17662	164	17864	159
17169	179	17309	159	17456	168	17572	164	17663	164	17865	159
17170	179	17310	159	17458	168	17573	164	17664	164	17866	159
17172	178	17311	159	17459	168	17574	164	17665	164	17867	159
17175	180	17312	159	17460	164	17575	164	17666	164	17868	159
17177	180	17313	159	17461	164	17576	164	17667	164	17869	159
17178	172	17314	159	17462	164	17577	164	17668	164	17870	159
17180	172	17315	159	17463	164	17578	164	17669	164	17871	159
17181	172	17316	159	17464	164	17579	164	17670	164	17872	159
17182	45	17317	159	17465	164	17580	164	17671	164	17873	159
17182	137	17318	159	17467	164	17581	164	17672	164	17874	159
17183	45	17319	159	17468	164	17582	164	17674	164	17875	159
17183	137	17320	159	17469	164	17583	164	17675	164	17876	159
17185	181	17321	159	17470	164	17584	164	17676	164	17877	159
17186	180	17322	159	17471	164	17585	164	17677	164	17878	159
17187	181	17324	159	17472	164	17586	164	17678	164	17879	159
17188	181	17327	159	17473	164	17587	164	17679	164	17880	159
17189	181	17330	159	17475	166	17589	164	17680	168	17881	159
17190	174	17332	159	17476	166	17590	164	17681	168	17882	159
17191	174	17333	159	17480	164	17591	164	17682	168	17883	159
17192	174	17334	159	17481	164	17592	164	17683	164	17884	159
17193	174	17338	167	17482	164	17593	164	17685	165	17885	159
17197	165	17341	178	17483	164	17600	167	17761	164	17886	159
17198	165	17342	178	17484	164	17601	167	17769	164	17887	159
17199	165	17350	162	17485	164	17603	167	17788	164	17888	159
17200	165	17351	162	17486	164	17605	164	17795	164	17889	159
17201	165	17352	162	17487	164	17606	164	17806	164	17890	159
17202	165	17353	162	17488	164	17607	164	17810	161	17891	159
17203	167	17357	162	17489	164	17608	164	17811	161	17892	159
17204	167	17359	162	17490	164	17609	164	17812	161	17895	159
17205	167	17361	162	17491	164	17610	164	17820	159	17896	159
17206	167	17380	161	17492	164	17611	164	17821	159	17897	159
17229	155	17381	161	17493	164	17612	164	17822	159	17898	159
17230	155	17382	160	17494	164	17613	164	17823	159	17904	159
17231	155	17383	160	17495	164	17614	164	17824	159	17905	159
17233	155	17384	160	17496	164	17615	164	17825	159	17907	159
17234	155	17385	160	17501	166	17616	164	17826	159	17910	159
17235	156	17386	160	17506	165	17617	164	17827	159	17914	159
17236	156	17390	160	17508	165	17619	165	17828	159	17916	159
17237	154	17391	160	17512	166	17620	166	17829	159	17922	159
17238	153	17392	160	17526	165	17621	166	17830	159	17924	159

СПИСЪК С АРТИКУЛИ

Арт. номер	Стр.	Арт. номер	Стр.	Арт. номер	Стр.	Арт. номер	Стр.	Арт. номер	Стр.	Арт. номер	Стр.
17926	159	18302	143	18498	163	18638	147	18828	148	18971	160
17930	159	18303	143	18499	163	18639	147	18829	148	18993	150
17934	159	18304	143	18500	163	18640	147	18830	148	18994	150
17935	159	18310	140	18501	162	18641	147	18831	148	19001	197
17943	159	18311	140	18508	163	18645	147	18832	148	19002	197
17944	159	18312	140	18510	162	18646	147	18835	148	19003	197
17970	148	18313	140	18511	162	18680	147	18836	148	19004	197
17971	148	18321	140	18512	162	18685	147	18837	148	19005	197
17972	148	18322	140	18513	162	18710	146	18838	148	19006	197
17973	148	18340	141	18514	162	18711	146	18839	148	19008	197
17974	148	18350	140	18515	162	18712	146	18840	148	19010	197
17975	148	18351	140	18516	162	18715	146	18841	148	19015	197
17976	148	18352	140	18518	162	18716	146	18842	148	19020	197
17980	148	18353	140	18519	162	18717	146	18843	148	19021	195
17981	148	18354	140	18520	162	18720	146	18844	148	19022	195
17982	148	18355	140	18521	162	18721	146	18845	148	19023	195
17983	148	18356	140	18522	162	18722	146	18846	148	19024	195
18062	142	18357	140	18523	162	18723	146	18847	148	19025	195
18063	142	18358	140	18524	162	18724	146	18850	148	19026	195
18064	142	18359	140	18527	162	18725	146	18851	148	19028	195
18065	142	18360	140	18567	162	18750	147	18852	148	19030	195
18066	142	18400	143	18572	162	18751	147	18853	148	19031	195
18067	142	18401	143	18575	162	18753	147	18855	148	19032	195
18070	142	18402	141	18576	162	18755	147	18856	148	19034	195
18071	142	18403	141	18577	162	18760	147	18860	148	19036	195
18072	142	18404	141	18578	162	18761	147	18861	148	19041	195
18075	142	18408	145	18579	162	18762	147	18862	148	19042	195
18076	142	18409	145	18580	162	18763	147	18863	148	19043	195
18077	142	18410	142	18581	162	18764	147	18864	148	19044	195
18080	142	18411	142	18582	162	18765	147	18865	148	19045	195
18081	142	18413	142	18583	162	18766	147	18866	148	19046	195
18082	142	18415	144	18584	162	18767	147	18867	148	19050	197
18083	142	18416	144	18585	162	18768	147	18868	148	19051	197
18084	142	18417	144	18587	162	18769	147	18869	148	19052	197
18085	142	18418	143	18588	162	18770	147	18870	148	19053	197
18086	142	18419	144	18589	162	18771	147	18871	148	19054	197
18087	142	18420	144	18593	162	18772	147	18872	148	19055	197
18088	142	18421	152	18600	149	18775	147	18873	148	19056	197
18089	142	18422	141	18601	149	18776	147	18874	148	19057	197
18090	142	18423	142	18602	149	18777	147	18900	151	19058	195
18091	142	18424	141	18603	158	18795	149	18901	151	19059	195
18092	142	18425	140	18604	161	18796	149	18905	151	19060	196
18101	143	18426	145	18605	149	18797	149	18906	151	19061	196
18102	143	18427	145	18607	149	18798	149	18907	152	19062	196
18103	143	18428	115	18608	144	18799	149	18908	151	19063	196
18104	143	18429	115	18609	150	18800	148	18909	151	19064	196
18105	143	18430	152	18610	150	18801	148	18910	145	19065	196
18106	143	18431	144	18611	150	18802	148	18915	152	19066	195
18107	143	18432	146	18612	150	18803	148	18920	160	19067	195
18108	143	18433	144	18613	150	18804	148	18921	160	19068	195
18110	143	18434	140	18614	150	18805	148	18922	160	19069	195
18113	140	18435	145	18615	150	18806	148	18925	160	19070	195
18114	140	18437	145	18618	150	18807	148	18926	160	19071	195
18115	140	18440	152	18619	149	18810	148	18927	160	19074	195
18116	140	18445	173	18619	161	18811	148	18928	160	19075	195
18118	140	18450	143	18620	147	18812	148	18929	160	19076	195
18120	140	18451	143	18621	147	18813	148	18930	160	19077	195
18124	140	18455	143	18623	147	18814	148	18931	160	19081	195
18125	140	18456	143	18625	147	18815	148	18934	160	19082	195
18201	143	18460	143	18627	147	18816	148	18939	160	19083	195
18202	143	18476	162	18628	147	18817	148	18948	160	19084	195
18203	143	18490	163	18630	147	18820	148	18950	160	19085	195
18204	143	18491	163	18631	147	18821	148	18951	160	19086	195
18210	140	18492	163	18632	147	18822	148	18954	160	19088	195
18211	140	18493	163	18633	147	18823	148	18955	160	19090	195
18212	140	18494	162	18634	147	18824	148	18956	160	19092	195
18215	140	18495	162	18635	147	18825	148	18960	160	19095	195
18216	140	18496	163	18636	147	18826	148	18961	160	19096	195
18301	143	18497	163	18637	147	18827	148	18963	160	19097	195

Арт. номер	Стр.	Арт. номер	Стр.	Арт. номер	Стр.	Арт. номер	Стр.	Арт. номер	Стр.	Арт. номер	Стр.
19098	195	19394	317	19473	202	19580	56	19643	56	19704	57
19100	196	19395	317	19474	202	19585	56	19644	56	19705	57
19106	195	19396	317	19477	202	19585	56	19645	56	19705	57
19108	195	19397	317	19478	202	19586	56	19645	56	19706	57
19109	195	19398	197	19480	202	19587	56	19646	56	19707	57
19110	200	19399	197	19481	202	19588	56	19647	56	19708	57
19115	44	19400	201	19483	202	19589	56	19648	56	19708	57
19115	197	19400	251	19485	201	19590	56	19649	56	19709	57
19124	196	19401	201	19486	201	19590	56	19650	56	19710	57
19136	196	19401	251	19487	201	19591	56	19650	56	19711	57
19148	196	19402	201	19490	135	19593	56	19651	56	19711	57
19149	196	19402	251	19491	135	19594	56	19652	56	19712	57
19150	196	19403	201	19492	135	19595	56	19653	56	19713	57
19151	196	19403	251	19493	135	19595	56	19654	56	19713	57
19202	198	19404	201	19494	135	19596	56	19655	56	19714	57
19208	199	19404	251	19495	135	19597	56	19656	56	19715	57
19209	199	19405	201	19496	135	19598	56	19657	56	19716	57
19211	199	19405	251	19497	135	19599	56	19658	56	19717	57
19245	198	19406	201	19498	135	19600	56	19659	56	19718	57
19246	198	19406	251	19499	135	19600	56	19660	56	19718	57
19247	198	19407	201	19501	135	19601	56	19661	56	19719	57
19248	198	19407	251	19502	135	19603	56	19662	56	19720	57
19249	198	19408	201	19510	134	19604	56	19663	56	19721	57
19251	199	19408	251	19515	134	19605	56	19664	56	19722	57
19252	199	19409	201	19520	134	19605	56	19665	56	19723	57
19253	199	19409	251	19530	56	19606	56	19669	56	19723	57
19254	199	19410	201	19530	56	19607	56	19670	57	19724	57
19255	199	19411	201	19535	56	19608	56	19671	57	19725	57
19265	199	19412	201	19535	56	19609	56	19672	57	19726	57
19270	199	19415	200	19536	56	19610	56	19673	57	19727	57
19271	199	19416	200	19537	56	19610	56	19673	57	19728	57
19272	199	19418	201	19538	56	19611	56	19674	57	19728	57
19281	199	19419	201	19539	56	19612	56	19675	57	19729	57
19290	199	19420	200	19540	56	19613	56	19676	57	19730	57
19293	199	19421	200	19540	56	19614	56	19677	57	19731	57
19294	199	19422	200	19543	56	19615	56	19678	57	19732	57
19295	199	19423	200	19544	56	19615	56	19678	57	19733	57
19297	199	19424	200	19545	56	19616	56	19679	57	19733	57
19301	316	19425	200	19545	56	19617	56	19680	57	19734	57
19303	196	19426	200	19550	56	19618	56	19681	57	19735	57
19306	317	19427	200	19550	56	19619	56	19682	57	19736	57
19308	317	19429	201	19552	56	19620	56	19683	57	19737	57
19310	317	19430	197	19552	56	19620	56	19683	57	19738	57
19312	317	19431	197	19554	56	19621	56	19684	57	19738	57
19314	317	19432	197	19555	56	19622	56	19685	57	19739	57
19326	316	19433	197	19555	56	19623	56	19686	57	19740	57
19328	316	19434	197	19557	56	19624	56	19687	57	19741	57
19330	316	19435	197	19558	56	19625	56	19688	57	19742	57
19332	316	19436	201	19559	56	19625	56	19688	57	19743	57
19333	316	19440	197	19560	56	19626	56	19689	57	19743	57
19335	316	19441	197	19560	56	19627	56	19690	57	19744	57
19337	316	19442	197	19562	56	19628	56	19691	57	19745	57
19340	316	19443	197	19562	56	19629	56	19692	57	19746	57
19370	317	19450	135	19564	56	19630	56	19693	57	19747	57
19371	317	19451	135	19565	56	19630	56	19693	57	19748	57
19374	317	19455	135	19565	56	19631	56	19694	57	19748	57
19380	316	19457	135	19567	56	19632	56	19695	57	19749	57
19381	316	19458	135	19568	56	19633	56	19695	57	19750	57
19382	316	19459	135	19568	56	19634	56	19696	57	19751	57
19383	316	19460	201	19570	56	19635	56	19697	57	19752	57
19384	316	19460	251	19570	56	19635	56	19698	57	19753	57
19385	316	19462	317	19574	56	19636	56	19698	57	19753	57
19387	316	19463	317	19575	56	19637	56	19699	57	19754	57
19388	316	19464	317	19575	56	19638	56	19700	57	19755	57
19389	316	19465	317	19576	56	19639	56	19701	57	19756	57
19390	316	19469	317	19577	56	19640	56	19701	57	19757	57
19391	316	19470	201	19578	56	19640	56	19702	57	19758	57
19392	316	19470	251	19579	56	19641	56	19703	57	19758	57
19393	317	19472	202	19580	56	19642	56	19703	57	19759	57

СПИСЪК С АРТИКУЛИ

Арт. номер	Стр.	Арт. номер	Стр.	Арт. номер	Стр.	Арт. номер	Стр.	Арт. номер	Стр.	Арт. номер	Стр.
19760	57	20300	59	20489	61	20751	67	20896	63	21110	75
19761	57	20305	59	20490	61	20752	67	20897	63	21111	75
19762	57	20310	59	20491	61	20753	67	20898	63	21112	75
19763	57	20311	59	20492	61	20754	67	20899	63	21115	75
19763	57	20315	60	20493	61	20755	67	20901	64	21118	75
19764	57	20316	59	20494	61	20756	67	20905	64	21123	75
19765	57	20317	59	20495	61	20757	67	20910	64	21130	75
19766	57	20320	60	20496	61	20758	67	20911	63	21135	75
19767	57	20321	60	20508	67	20759	67	20912	63	21140	75
19768	57	20333	58	20510	67	20760	67	20913	63	21150	75
19768	57	20334	58	20511	67	20761	67	20915	63	21180	75
19769	57	20335	58	20512	67	20762	67	20916	63	21190	75
19770	57	20336	58	20513	67	20764	67	20917	63	21192	77
19771	57	20337	58	20514	67	20765	67	20918	63	21194	77
19772	57	20338	58	20515	67	20766	67	20919	63	21195	75
19772	57	20340	60	20516	67	20767	67	20920	63	21200	74
19773	57	20350	202	20520	67	20768	67	20921	63	21201	74
19774	57	20360	139	20521	67	20769	67	20922	63	21203	74
19775	57	20361	139	20522	67	20770	67	20923	63	21204	74
19776	57	20363	180	20523	67	20771	67	20924	63	21205	74
19776	57	20364	180	20524	67	20772	67	20932	69	21209	74
19777	57	20365	29	20525	67	20773	67	20936	69	21210	75
19778	57	20379	29	20526	67	20774	67	20937	69	21211	75
19779	57	20380	60	20673	67	20775	67	20938	69	21212	75
19780	57	20381	64	20674	67	20776	67	20939	69	21215	75
19781	57	20385	62	20675	67	20777	67	20940	69	21218	75
19781	57	20386	62	20676	67	20778	67	20941	69	21219	75
19782	57	20387	62	20677	67	20779	67	20942	69	21220	75
19783	57	20390	62	20678	67	20780	67	20943	69	21223	75
19783	57	20391	62	20680	67	20781	67	20944	69	21224	75
19784	57	20394	62	20682	67	20782	67	20945	69	21230	74
19785	57	20395	62	20684	67	20783	67	20946	69	21231	74
19786	57	20396	62	20685	67	20784	67	20947	69	21234	74
19786	57	20397	62	20686	67	20785	67	20948	69	21235	74
19787	57	20400	58	20687	67	20786	67	20949	69	21238	74
19788	57	20401	58	20688	67	20787	67	20950	68	21301	75
19789	57	20402	58	20690	67	20788	67	20952	68	21303	75
19790	57	20403	58	20691	67	20789	67	20954	68	21306	77
19791	57	20404	58	20692	67	20790	67	20956	69	21308	77
19792	57	20405	58	20694	67	20791	67	20957	63	21311	75
19793	57	20406	58	20696	67	20792	67	20958	63	21312	75
19794	57	20407	58	20697	67	20793	67	20960	29	21315	75
19795	57	20408	58	20698	67	20794	67	20961	29	21318	75
19796	57	20409	58	20724	63	20795	67	20963	29	21323	75
19797	57	20410	58	20725	63	20796	67	20965	29	21324	75
19798	57	20411	58	20726	63	20797	67	20966	29	21326	75
19799	57	20412	58	20727	63	20798	67	20967	166	21327	75
19800	57	20413	58	20728	63	20799	67	20968	166	21411	75
19801	57	20414	58	20729	63	20805	68	20970	202	21412	75
19802	57	20415	58	20730	63	20820	68	20971	202	21415	75
19841	58	20416	58	20731	63	20825	67	20972	202	21418	75
19842	58	20417	58	20732	63	20855	67	20973	202	21423	75
19845	58	20418	58	20733	63	20861	67	20980	63	21424	75
19885	58	20419	58	20734	63	20862	67	20981	63	21425	76
19895	58	20420	58	20735	63	20870	67	20982	63	21426	76
20210	64	20421	58	20736	63	20871	67	20983	63	21427	76
20220	57	20422	58	20737	63	20872	67	20984	63	21428	76
20225	57	20423	58	20738	63	20873	67	20990	69	21430	76
20230	57	20424	58	20739	63	20874	67	20991	69	21431	76
20235	57	20425	58	20740	63	20875	67	20992	69	21432	76
20240	57	20426	58	20741	63	20876	67	20996	68	21435	76
20245	57	20427	58	20742	150	20877	67	20997	69	21436	76
20250	57	20428	58	20743	29	20878	67	20999	68	21437	76
20255	57	20429	58	20743	149	20879	67	21010	75	21440	64
20260	57	20430	58	20744	29	20880	67	21011	75	21441	64
20270	57	20450	64	20745	29	20881	67	21012	75	21442	64
20280	57	20460	64	20748	67	20890	68	21015	75	21443	64
20290	57	20487	61	20749	67	20891	68	21018	75	21444	64
20296	57	20488	61	20750	67	20895	68	21023	75	21445	64

Арт. номер	Стр.	Арт. номер	Стр.	Арт. номер	Стр.	Арт. номер	Стр.	Арт. номер	Стр.	Арт. номер	Стр.
21446	64	21803	78	22012	81	22083	82	22170	189	22277	76
21450	66	21804	78	22013	81	22084	82	22171	189	22280	76
21451	66	21805	78	22014	81	22085	82	22172	189	22281	76
21452	66	21806	78	22015	81	22086	187	22173	189	22285	76
21453	66	21807	65	22016	81	22087	83	22174	189	22286	76
21454	66	21807	78	22017	81	22088	82	22178	188	22294	76
21530	64	21808	65	22018	81	22090	82	22180	188	22300	86
21531	63	21808	78	22019	81	22091	83	22181	188	22301	86
21532	63	21809	79	22020	81	22092	83	22182	188	22302	86
21533	63	21810	84	22021	81	22093	83	22183	188	22303	86
21534	63	21811	84	22022	81	22095	82	22184	188	22305	86
21535	63	21812	84	22023	81	22096	84	22185	188	22307	86
21536	63	21813	84	22024	81	22097	84	22186	188	22309	86
21540	66	21814	84	22025	81	22098	84	22188	189	22310	86
21541	66	21831	84	22026	81	22099	84	22189	189	22311	86
21701	84	21832	84	22027	81	22100	85	22190	189	22312	86
21702	84	21834	84	22028	81	22101	85	22196	189	22313	86
21703	84	21850	85	22029	81	22102	85	22197	189	22314	86
21704	84	21851	85	22030	81	22103	85	22198	189	22315	86
21705	84	21852	85	22031	81	22104	85	22199	189	22316	86
21706	84	21853	85	22032	82	22105	85	22200	70	22317	86
21709	84	21854	85	22033	187	22106	85	22201	70	22318	86
21715	84	21855	85	22034	187	22107	85	22202	189	22319	86
21716	84	21856	85	22035	187	22108	85	22203	189	22320	86
21717	84	21857	85	22036	187	22109	85	22204	189	22322	86
21718	84	21858	85	22037	80	22110	85	22205	189	22324	86
21719	84	21859	85	22038	80	22111	85	22206	188	22326	86
21720	84	21860	85	22039	81	22112	85	22207	188	22328	86
21721	84	21861	85	22040	81	22113	85	22208	188	22329	86
21724	84	21862	85	22041	83	22115	85	22209	188	22332	86
21732	84	21863	85	22042	83	22116	85	22211	77	22333	86
21734	84	21864	85	22043	83	22117	85	22212	77	22335	86
21735	84	21900	80	22044	83	22119	85	22215	77	22337	86
21736	84	21901	80	22045	84	22120	293	22216	77	22340	86
21737	84	21902	80	22046	84	22121	293	22217	77	22343	86
21740	84	21903	80	22047	84	22122	293	22218	77	22345	86
21741	84	21904	80	22048	84	22123	293	22219	77	22350	86
21742	84	21905	80	22049	84	22124	293	22220	77	22351	86
21743	84	21906	80	22050	84	22125	293	22222	77	22355	86
21744	84	21907	80	22051	84	22126	293	22224	77	22357	86
21750	84	21908	80	22052	84	22129	293	22225	77	22365	86
21751	84	21909	81	22053	84	22130	293	22228	77	22370	86
21752	84	21910	81	22054	84	22132	293	22229	77	22398	86
21753	84	21911	80	22055	84	22133	293	22230	77	22399	86
21754	84	21912	80	22056	84	22134	293	22232	77	22510	56
21760	79	21913	80	22057	84	22135	350	22234	77	22515	56
21761	79	21914	80	22058	81	22136	350	22236	77	22520	56
21762	79	21920	80	22059	81	22137	350	22238	77	22525	56
21763	79	21925	80	22060	83	22138	350	22240	77	22530	56
21764	79	21926	80	22061	83	22140	79	22242	77	22532	56
21780	79	21930	82	22062	83	22141	79	22244	77	22535	56
21781	79	21931	82	22063	83	22142	79	22246	77	22540	56
21782	79	21935	82	22064	83	22143	79	22248	77	22542	56
21783	79	21936	82	22065	83	22145	79	22251	77	22545	56
21784	79	21937	82	22066	83	22146	79	22252	77	22548	56
21786	79	21940	82	22067	85	22147	79	22253	77	22550	56
21787	79	21941	82	22070	83	22148	79	22254	77	22555	56
21788	79	21950	81	22071	83	22150	79	22255	77	22560	56
21789	79	22001	80	22072	83	22151	79	22258	76	22565	56
21790	79	22002	80	22073	83	22155	79	22259	76	22568	56
21792	79	22003	80	22074	83	22156	79	22260	76	22570	56
21793	79	22004	80	22075	85	22158	187	22263	76	22575	56
21794	79	22005	80	22076	85	22159	187	22264	76	22580	56
21795	79	22006	80	22077	85	22160	83	22266	76	22585	56
21796	79	22007	80	22078	187	22161	83	22269	76	22590	56
21798	79	22008	80	22079	187	22162	83	22270	76	22595	56
21800	78	22009	80	22080	187	22163	83	22273	76	22600	56
21801	78	22010	80	22081	187	22164	83	22274	76	22602	56
21802	78	22011	80	22082	187	22167	83	22275	76	22605	56

СПИСЪК С АРТИКУЛИ

Арт. номер	Стр.	Арт. номер	Стр.	Арт. номер	Стр.	Арт. номер	Стр.	Арт. номер	Стр.	Арт. номер	Стр.
22610	56	23658	209	23973	183	24111	190	24197	93	24676	72
22615	56	23660	210	23974	183	24114	191	24301	90	24677	72
22620	56	23661	209	23975	183	24115	191	24302	90	24678	72
22625	56	23664	209	23976	183	24118	93	24303	90	24680	276
22630	56	23670	203	23977	183	24119	93	24304	90	24690	202
22701	82	23671	203	23978	183	24120	93	24305	90	24691	202
22702	82	23672	203	23979	183	24121	190	24306	90	24695	202
22703	82	23673	203	23985	183	24122	190	24308	90	24700	72
22704	82	23674	203	23986	183	24124	190	24310	90	24701	72
22705	82	23675	203	23987	183	24125	190	24312	91	24702	72
22706	82	23676	203	23988	183	24126	190	24313	91	24703	72
22707	82	23677	203	23989	183	24128	193	24314	91	24704	72
23270	239	23678	203	24000	183	24130	192	24315	91	24705	72
23400	212	23679	203	24001	183	24131	192	24316	91	24706	65
23401	212	23680	203	24005	183	24132	134	24320	87	24710	73
23402	212	23681	203	24007	182	24133	192	24321	87	24712	65
23406	212	23682	203	24008	183	24134	191	24322	87	24713	65
23407	212	23683	203	24010	182	24135	192	24325	91	24714	65
23410	212	23684	203	24015	182	24136	192	24410	60	24715	65
23411	212	23685	203	24017	182	24137	192	24411	60	24716	65
23412	212	23730	168	24020	182	24140	192	24412	60	24717	69
23415	212	23731	168	24030	182	24141	192	24415	65	24718	69
23416	212	23732	168	24035	183	24142	192	24419	60	24719	69
23417	212	23734	168	24036	183	24143	191	24420	60	24720	65
23420	205	23735	168	24038	183	24144	191	24422	60	24721	65
23506	204	23736	168	24039	183	24145	191	24425	60	24722	65
23507	204	23760	185	24040	183	24147	191	24429	60	24723	69
23508	204	23761	185	24041	183	24148	192	24432	60	24725	70
23515	204	23762	185	24042	183	24149	191	24435	60	24726	70
23520	204	23763	185	24043	183	24150	192	24437	60	24727	290
23525	204	23764	185	24045	89	24151	192	24444	60	24728	290
23530	204	23800	184	24050	91	24152	193	24451	60	24729	290
23531	204	23840	322	24055	88	24152	315	24457	60	24730	69
23551	204	23845	323	24055	277	24153	190	24464	60	24731	69
23560	204	23846	323	24060	88	24155	194	24468	60	24732	69
23561	204	23847	323	24061	88	24156	194	24476	60	24734	73
23562	204	23875	223	24062	88	24158	194	24483	60	24735	70
23563	204	23875	357	24063	88	24159	194	24620	71	24736	70
23564	204	23904	185	24064	88	24159	293	24621	71	24737	70
23565	204	23906	185	24065	88	24160	93	24622	71	24738	70
23566	204	23908	185	24066	88	24161	93	24623	71	24739	70
23570	203	23910	185	24067	88	24162	93	24624	71	24740	70
23571	203	23912	185	24068	88	24163	93	24627	71	24741	70
23572	203	23914	185	24069	88	24164	93	24630	71	24743	70
23573	203	23920	184	24070	88	24165	93	24633	71	24745	70
23574	203	23922	184	24071	88	24166	93	24636	71	24746	70
23585	203	23923	184	24072	88	24167	93	24638	71	24747	70
23587	203	23924	184	24073	88	24168	93	24640	71	24748	70
23589	203	23925	184	24074	88	24169	93	24642	71	24749	70
23591	203	23927	184	24075	88	24170	190	24643	71	24750	61
23595	204	23928	184	24076	88	24171	192	24647	79	24751	61
23598	204	23945	184	24077	88	24173	192	24648	79	24752	290
23600	205	23950	183	24078	88	24174	194	24649	79	24753	290
23601	205	23951	183	24080	89	24175	194	24650	72	24755	66
23602	205	23952	183	24081	89	24176	194	24651	71	24756	66
23605	205	23953	183	24082	89	24177	194	24652	71	24757	69
23607	205	23954	183	24083	89	24178	194	24655	73	24758	69
23620	205	23955	183	24084	89	24180	93	24658	73	24759	69
23625	203	23960	185	24085	89	24181	194	24661	72	24760	72
23626	203	23961	185	24086	89	24185	93	24663	72	24761	72
23628	203	23962	185	24087	89	24186	93	24665	82	24762	72
23630	203	23963	185	24098	89	24187	93	24666	82	24763	72
23632	203	23964	185	24099	89	24188	93	24667	82	24764	72
23635	203	23965	185	24100	190	24189	93	24670	72	24765	72
23637	204	23966	185	24102	190	24190	194	24671	72	24766	72
23650	210	23967	185	24104	190	24190	293	24672	72	24767	72
23652	208	23970	183	24108	93	24192	93	24673	72	24768	72
23655	210	23971	183	24109	93	24195	93	24674	72	24769	72
23657	208	23972	183	24110	190	24196	93	24675	72	24770	70

Арт. номер	Стр.	Арт. номер	Стр.	Арт. номер	Стр.	Арт. номер	Стр.	Арт. номер	Стр.	Арт. номер	Стр.
24771	70	25206	305	28032	11	31082	245	31502	252	32166	248
24772	70	25212	305	28035	13	31091	244	31503	252	32167	248
24773	70	25215	305	28040	12	31101	244	31505	247	32168	248
24774	70	25220	305	28045	12	31111	244	31506	247	32169	248
24775	71	25224	305	28050	14	31121	244	31507	247	32170	247
24776	72	25230	305	28055	14	31131	244	31510	247	32171	248
24777	71	25240	305	28060	17	31132	244	31511	247	32172	248
24778	71	25248	305	28061	17	31140	244	31512	247	32173	247
24779	72	25260	305	28065	17	31141	244	31513	247	32174	248
24780	73	25296	305	28070	10	31142	244	31514	247	32176	248
24781	73	25350	305	28075	15	31143	244	31515	247	32186	248
24782	73	25369	305	28076	18	31144	244	31517	247	32196	248
24783	73	25370	305	28080	19	31145	244	31519	252	32206	248
24784	73	25371	305	28081	19	31146	244	31520	249	32216	248
24785	73	25372	305	28083	19	31148	244	31521	249	32226	248
24786	73	25373	305	28085	19	31150	245	31522	249	32234	248
24787	73	25374	305	28086	19	31151	245	31523	249	32240	248
24788	73	25376	305	28090	20	31155	245	31524	249	32265	250
24789	73	25378	305	28101	21	31218	247	31541	249	32268	251
24790	72	25379	305	28102	20	31220	246	31551	249	32269	251
24791	72	25380	305	28103	20	31221	246	31552	249	32270	250
24792	72	25400	305	28104	21	31222	246	31553	249	32273	250
24793	72	25410	305	28210	28	31231	246	31555	249	32283	250
24794	72	26028	111	28213	28	31232	246	31556	249	32285	250
24795	71	26201	113	28215	27	31233	246	31557	249	32293	250
24796	72	26203	112	28218	28	31234	246	31558	249	32295	251
24797	71	26204	113	28220	25	31235	246	31559	249	32296	251
24798	73	26205	112	28221	23	31270	246	31601	253	32297	251
24799	71	26209	114	28223	28	31271	246	31602	253	32298	251
25001	305	26211	113	28225	24	31280	246	31603	253	32301	251
25002	305	26216	114	28228	28	31281	246	31610	249	32302	251
25003	305	26217	114	28229	28	31320	247	31641	253	32311	255
25004	305	26218	114	28230	26	31322	247	31651	253	32312	254
25005	305	26219	114	28233	28	31330	246	31655	253	32313	251
25006	305	26520	115	28240	36	31332	246	32001	250	32314	254
25009	305	26521	115	28267	29	31334	246	32002	250	32315	255
25012	305	26705	228	28275	50	31340	246	32003	250	32316	255
25015	305	26706	228	28278	50	31341	246	32013	250	32317	254
25016	305	26707	228	28280	50	31343	246	32014	250	32318	255
25020	305	26720	228	28282	50	31360	246	32015	250	32319	255
25024	305	26721	228	28340	37	31362	246	32016	250	32320	254
25025	305	26722	228	28342	37	31380	246	32018	250	32321	255
25030	305	26730	272	28345	37	31382	246	32020	250	32322	255
25040	305	26731	272	28346	37	31390	246	32021	250	32323	255
25048	305	26735	272	30003	256	31392	246	32022	253	32324	255
25060	305	26736	272	30003	259	31400	246	32023	253	32325	255
25096	305	26740	273	30004	256	31402	246	32024	250	32326	255
25150	305	26775	292	30004	259	31403	246	32026	250	32327	254
25153	305	26780	273	30005	256	31404	246	32037	251	32328	255
25155	305	26781	273	30005	259	31452	253	32038	251	32329	254
25160	305	26782	273	30007	256	31453	253	32040	253	32330	255
25162	305	26783	273	30007	259	31454	253	32041	253	32331	255
25163	305	26973	216	31005	245	31455	247	32042	253	32332	254
25164	305	26974	216	31006	245	31456	247	32043	253	32333	254
25167	305	26975	216	31007	245	31461	248	32044	253	32335	255
25169	305	26976	216	31008	245	31467	248	32050	253	32337	254
25170	305	26977	216	31009	245	31468	248	32051	253	32338	254
25171	305	28000	4	31011	245	31471	248	32052	253	33168	254
25179	305	28001	5	31021	245	31481	248	32053	253	33275	296
25180	305	28002	5	31031	245	31491	248	32060	250	34005	256
25181	305	28003	6	31041	245	31493	248	32062	250	34006	256
25182	305	28004	6	31051	245	31494	248	32064	250	34007	256
25183	305	28005	7	31052	245	31495	248	32066	250	34027	255
25184	305	28006	7	31053	245	31496	248	32089	251	34028	255
25186	305	28007	8	31061	245	31497	252	32161	248	34033	260
25188	305	28008	8	31062	245	31498	248	32162	248	34041	256
25189	305	28021	9	31071	245	31499	248	32163	248	34051	256
25190	305	28025	9	31072	245	31500	248	32164	248	34053	256
25195	305	28030	11	31081	245	31501	252	32165	248	34061	256

СПИСЪК С АРТИКУЛИ

Арт. номер	Стр.	Арт. номер	Стр.	Арт. номер	Стр.	Арт. номер	Стр.	Арт. номер	Стр.	Арт. номер	Стр.
34071	256	34405	258	35082	263	35345	40	36130	277	37115	291
34081	256	34406	259	35085	262	35345	286	36136	277	37117	278
34091	256	34407	259	35086	262	35346	41	36138	277	37119	291
34101	256	34409	259	35087	262	35346	288	36139	277	37120	291
34111	256	34410	259	35091	262	35347	41	36140	277	37121	296
34115	256	34411	259	35092	262	35347	288	36145	274	37122	296
34116	256	34412	259	35093	262	35348	40	36160	274	37123	364
34117	256	34413	259	35094	263	35348	286	36175	274	37124	364
34121	256	34414	259	35095	263	35360	46	36190	274	37125	282
34122	256	34415	258	35096	263	35361	46	36191	274	37126	282
34132	256	34416	258	35103	264	35362	46	36195	277	37127	282
34142	256	34417	259	35113	264	35500	266	36199	274	37129	364
34152	256	34418	259	35123	264	35501	266	36200	274	37130	281
34153	256	34419	258	35125	264	35502	266	36300	209	37131	281
34154	256	34420	258	35126	264	35503	266	36308	292	37132	281
34155	256	34421	259	35127	264	35504	266	36310	273	37135	231
34156	256	34422	259	35142	262	35505	266	36312	292	37139	231
34157	256	34423	259	35300	38	35506	266	36318	283	37140	231
34158	256	34424	259	35300	261	35507	266	36319	283	37141	231
34159	256	34425	259	35305	39	35508	266	36325	283	37142	231
34160	256	34426	259	35305	262	35510	266	36326	16	37143	231
34200	252	34428	259	35310	38	35511	266	36326	283	37144	231
34201	252	34429	259	35310	261	35512	266	36328	16	37145	231
34202	252	34439	258	35311	38	35514	266	36329	16	37148	282
34203	252	34440	258	35311	261	35515	266	36410	208	37149	282
34221	260	34441	258	35315	39	35516	266	37005	302	37150	282
34223	260	34442	258	35315	262	35517	266	37006	279	37151	282
34231	260	34443	258	35316	38	35518	267	37006	279	37152	282
34235	260	34445	258	35316	261	35519	267	37007	279	37153	282
34237	260	34446	258	35317	38	35524	267	37007	279	37154	282
34238	260	34447	258	35317	261	35525	267	37008	279	37155	280
34241	260	34448	259	35318	38	35527	267	37009	279	37156	280
34243	260	34449	258	35318	261	35532	267	37011	278	37157	280
34251	260	34450	258	35319	38	35533	267	37012	279	37158	282
34261	260	34451	258	35319	261	35539	267	37021	278	37162	281
34262	260	34452	259	35320	50	35540	267	37025	278	37166	273
34265	260	34453	258	35322	50	35542	267	37025	278	37170	281
34271	252	34454	258	35323	42	35552	267	37026	278	37171	281
34272	252	34455	259	35323	289	35553	267	37026	278	37172	281
34273	252	34456	259	35325	42	35555	267	37028	278	37173	282
34274	252	34457	259	35325	289	35603	269	37028	278	37174	282
34275	252	34458	259	35326	42	35604	269	37029	278	37175	281
34276	252	34480	258	35326	289	35605	269	37029	278	37176	281
34280	252	34481	258	35327	42	35833	52	37031	253	37177	282
34281	252	34482	258	35327	289	35845	52	37041	253	37178	282
34282	252	34485	258	35328	42	35850	52	37050	278	37185	281
34283	252	34486	258	35328	42	36014	276	37051	253	37186	281
34284	252	34490	259	35328	289	36024	276	37052	278	37187	281
34285	252	34491	259	35328	289	36034	276	37053	278	37188	281
34300	292	34496	259	35329	42	36035	276	37054	278	37189	281
34301	252	34500	260	35329	42	36036	276	37055	278	37190	281
34303	292	35006	263	35329	289	36046	276	37065	284	37192	281
34304	252	35007	263	35329	289	36056	277	37066	284	37195	282
34305	252	35011	264	35330	40	36057	277	37067	284	37196	282
34305	292	35012	263	35330	287	36058	277	37068	284	37197	282
34306	252	35013	263	35331	41	36059	277	37069	284	37198	282
34306	292	35015	264	35331	288	36076	275	37070	284	37199	282
34307	252	35021	264	35332	41	36077	275	37094	284	37200	280
34307	292	35023	262	35332	288	36080	275	37095	284	37201	280
34308	252	35038	262	35333	41	36081	275	37096	284	37202	280
34308	292	35048	264	35333	288	36082	275	37097	284	37203	280
34315	293	35058	262	35334	41	36085	275	37098	284	37204	280
34316	131	35059	263	35334	288	36086	275	37101	253	37205	280
34316	293	35068	264	35335	42	36087	275	37102	280	37210	280
34400	258	35069	263	35335	289	36102	275	37105	280	37211	280
34401	258	35070	263	35336	41	36103	275	37106	280	37212	280
34402	259	35078	263	35336	288	36105	275	37107	280	37216	291
34403	259	35079	263	35344	41	36126	277	37111	253	37217	291
34404	258	35081	263	35344	287	36128	277	37114	291	37218	291

Арт. номер	Стр.	Арт. номер	Стр.	Арт. номер	Стр.	Арт. номер	Стр.	Арт. номер	Стр.	Арт. номер	Стр.
37220	280	37344	236	38022	299	38949	224	39217	290	42179	353
37230	292	37345	236	38024	297	38950	290	39218	290	42180	354
37231	292	37350	235	38025	298	38951	290	39219	290	42181	354
37232	292	37500	267	38026	279	38952	290	39238	292	42182	354
37233	292	37501	267	38027	297	38953	290	39240	290	42185	354
37234	292	37505	267	38028	297	38954	290	39241	290	42186	354
37235	292	37506	267	38030	299	38955	224	39242	290	42187	354
37236	291	37509	268	38031	299	38956	224	39243	290	42188	354
37237	291	37510	268	38032	297	38957	224	39244	290	42190	224
37238	291	37511	268	38042	279	38958	224	39245	292	42190	354
37239	291	37512	268	38045	279	38959	224	40050	353	42201	355
37243	303	37515	268	38050	223	38960	224	40051	353	42202	355
37244	303	37516	268	38052	223	38961	224	40052	353	42203	355
37245	303	37517	268	38054	223	38963	226	40053	353	42207	355
37246	303	37518	268	38055	223	38964	225	40054	353	42208	355
37247	303	37527	268	38060	223	38965	225	40055	353	42209	355
37248	303	37530	268	38063	223	38966	225	40056	353	42210	355
37250	303	37532	268	38065	223	38968	224	40057	353	42211	355
37251	303	37533	268	38095	223	38969	226	40058	353	42212	355
37252	303	37539	269	38096	223	38970	290	40059	353	42213	355
37253	303	37541	269	38097	223	38971	290	40060	353	42214	355
37255	225	37545	307	38895	284	38972	226	40075	353	42217	355
37256	225	37546	307	38896	284	38973	226	40076	353	42218	355
37257	225	37549	210	38899	284	38975	226	40077	353	42219	355
37258	225	37553	212	38900	284	38980	224	40100	352	42220	355
37259	225	37560	209	38901	285	38981	224	40120	352	42221	355
37263	225	37564	269	38902	285	38985	226	41050	352	42228	355
37264	225	37570	192	38903	285	38990	225	41080	352	42229	355
37266	225	37570	209	38904	285	38991	225	41081	352	42230	355
37267	225	37611	53	38905	285	38995	225	41082	352	42244	355
37268	225	37615	53	38906	285	39000	296	41083	352	42248	355
37270	225	37616	53	38907	284	39001	296	41100	352	42249	355
37271	225	37647	218	38908	284	39002	296	41101	352	42251	355
37272	225	37660	306	38909	284	39003	296	41102	352	42252	355
37273	225	37730	53	38910	285	39005	296	41103	352	42253	355
37275	225	37731	53	38911	285	39010	296	41120	352	42255	355
37280	226	37732	53	38912	285	39012	296	41121	352	42256	355
37281	226	37733	53	38913	285	39014	296	41122	352	42257	355
37285	282	37740	53	38914	285	39020	296	41123	352	42260	355
37286	282	37741	53	38915	285	39021	296	41150	352	42261	355
37287	282	37744	53	38916	285	39045	296	41151	352	42312	291
37288	282	37745	53	38917	285	39065	296	41152	352	42312	354
37289	282	37746	53	38918	285	39090	296	41153	352	42365	222
37290	303	37747	53	38919	279	39145	296	42101	352	42366	222
37291	303	37750	53	38920	279	39165	296	42102	352	42367	222
37295	226	37751	53	38923	279	39190	296	42103	352	42368	222
37296	226	37760	53	38924	225	39192	296	42115	291	42420	291
37297	226	37761	53	38925	224	39192	323	42120	291	43050	358
37300	235	38000	298	38926	226	39193	296	42150	353	43058	358
37301	235	38001	297	38927	224	39193	323	42151	353	43060	358
37302	235	38002	298	38928	225	39194	223	42152	353	43068	358
37303	235	38003	298	38929	225	39195	223	42153	353	43071	358
37308	236	38004	299	38930	226	39196	223	42155	353	43072	358
37309	236	38005	299	38931	224	39197	223	42156	353	43077	358
37310	235	38006	298	38932	224	39198	223	42157	353	43082	358
37311	235	38007	298	38933	226	39199	223	42158	353	43083	358
37317	313	38008	298	38934	225	39200	223	42160	353	43084	358
37320	235	38009	298	38935	226	39201	223	42161	353	43086	358
37321	235	38010	298	38937	226	39202	223	42162	353	43087	359
37325	234	38012	297	38939	226	39203	223	42163	353	43089	359
37326	234	38013	297	38940	226	39204	223	42170	354	43090	359
37328	234	38014	299	38941	226	39205	223	42171	354	43094	359
37330	234	38014	299	38942	225	39206	290	42172	354	43097	358
37331	234	38015	299	38943	226	39207	290	42173	354	43098	359
37332	234	38016	299	38944	224	39208	290	42174	354	43099	359
37340	236	38017	299	38945	224	39210	290	42175	353	43300	347
37341	236	38018	299	38946	224	39212	290	42176	353	43301	347
37342	236	38020	298	38947	224	39214	290	42177	353	44041	322
37343	236	38021	299	38948	224	39216	290	42178	353	44042	322

СПИСЪК С АРТИКУЛИ

Арт. номер	Стр.	Арт. номер	Стр.	Арт. номер	Стр.	Арт. номер	Стр.	Арт. номер	Стр.	Арт. номер	Стр.
44043	322	45034	319	45099	310	45178	333	45268	335	45391	324
44050	322	45035	318	45100	334	45179	331	45269	335	45392	324
44053	319	45036	322	45101	334	45180	327	45270	39	45393	324
44950	131	45038	319	45102	334	45181	327	45271	39	45394	324
44950	315	45039	319	45104	334	45182	333	45280	334	45395	324
44955	319	45040	319	45105	334	45183	333	45283	334	45396	325
44960	323	45041	319	45106	334	45184	331	45285	334	45397	325
44965	338	45042	319	45107	334	45185	331	45286	334	45398	325
44970	313	45043	323	45108	334	45186	331	45287	334	45399	325
44971	313	45044	322	45110	326	45187	332	45289	329	45400	325
44972	310	45045	136	45111	327	45190	332	45290	329	45401	325
44980	310	45045	320	45112	327	45191	332	45291	329	45450	357
44980	310	45046	136	45113	327	45192	332	45292	329	45451	357
44980	311	45046	320	45114	327	45193	332	45293	329	45452	357
44981	310	45047	323	45115	327	45194	332	45294	328	45453	357
44981	310	45048	136	45116	326	45195	332	45295	328	45460	357
44981	311	45048	312	45117	326	45196	332	45296	328	45461	357
44981	311	45048	320	45118	326	45197	332	45297	328	45462	357
44982	310	45049	322	45120	327	45198	332	45298	328	45463	357
44982	310	45050	338	45122	327	45199	332	45299	328	45465	357
44982	311	45051	338	45123	326	45200	332	45300	333	45466	357
44983	310	45052	338	45124	326	45203	332	45301	333	45467	357
44983	310	45053	339	45125	326	45204	332	45320	339	45470	357
44983	311	45054	339	45126	326	45206	332	45321	339	45471	226
44984	311	45055	339	45130	329	45211	332	45323	337	45471	323
44984	312	45056	318	45131	329	45213	328	45323	348	45472	323
44984	312	45057	318	45132	329	45214	327	45325	337	45473	323
44985	311	45058	318	45133	329	45215	329	45326	337	45480	357
44985	312	45059	318	45134	330	45216	328	45326	337	45485	357
44991	311	45060	193	45135	329	45217	329	45327	337	45490	314
44992	311	45060	315	45136	329	45218	328	45328	337	45496	357
44995	314	45061	193	45137	329	45219	329	45329	337	45497	357
44996	312	45061	315	45138	328	45220	334	45330	337	45498	357
44997	312	45062	193	45139	328	45221	334	45330	350	45499	357
44998	312	45062	315	45140	328	45222	334	45331	337	45500	321
44999	313	45063	310	45141	328	45223	334	45331	350	45502	321
45000	314	45065	318	45142	328	45224	334	45341	333	45503	321
45001	314	45066	318	45143	328	45225	334	45342	333	45505	321
45002	314	45067	318	45144	329	45226	334	45343	333	45506	321
45003	314	45068	136	45145	329	45227	334	45344	333	45508	321
45005	314	45068	312	45146	330	45228	334	45345	333	45509	321
45006	314	45068	320	45147	331	45229	334	45346	333	45511	321
45007	314	45069	131	45150	331	45239	336	45347	333	45512	321
45008	314	45069	315	45151	331	45240	336	45348	333	45513	321
45009	314	45070	340	45152	330	45241	336	45349	333	45515	321
45010	312	45071	338	45153	330	45242	336	45350	333	45516	321
45011	313	45073	136	45154	330	45244	335	45351	333	45517	321
45012	313	45073	320	45155	330	45245	335	45352	333	45518	321
45014	312	45074	323	45156	331	45246	335	45353	333	45519	321
45015	313	45079	319	45158	330	45247	335	45354	333	45520	321
45016	313	45080	319	45159	331	45248	335	45370	136	45521	321
45017	311	45081	131	45160	331	45249	335	45370	320	45522	321
45018	312	45081	315	45161	331	45250	335	45372	325	45523	321
45019	312	45082	131	45162	330	45251	335	45372	333	45524	321
45020	310	45082	315	45163	330	45253	335	45373	325	45525	321
45021	312	45083	131	45164	331	45254	335	45373	333	45526	321
45023	310	45083	315	45167	330	45256	335	45374	325	45527	321
45025	313	45084	131	45168	331	45257	335	45374	333	45528	321
45026	312	45084	315	45169	331	45260	335	45375	325	45529	321
45027	313	45085	319	45170	336	45261	335	45375	333	45530	321
45029	313	45086	323	45171	336	45262	335	45376	325	45531	321
45030	193	45088	311	45172	336	45262	335	45376	333	45532	321
45030	315	45089	311	45172	336	45263	335	45377	325	45533	321
45031	193	45093	323	45173	336	45263	335	45377	333	45534	321
45031	315	45094	311	45173	336	45265	335	45385	324	45535	322
45032	193	45095	310	45174	333	45266	335	45386	324	45540	321
45032	315	45096	310	45175	332	45267	335	45388	324	45541	321
45033	193	45097	311	45176	333	45267	335	45389	324	45542	321
45033	315	45098	310	45177	333	45268	335	45390	324	45543	321

Арт. номер	Стр.	Арт. номер	Стр.	Арт. номер	Стр.	Арт. номер	Стр.	Арт. номер	Стр.	Арт. номер	Стр.
45550	321	45660	322	48094	49	50544	233	51244	227	52055	307
45551	321	45661	322	48095	49	50549	232	51245	227	52060	307
45552	321	45662	322	48096	49	50550	230	51246	227	52065	307
45553	321	45663	322	48097	49	50551	230	51247	227	52070	300
45555	322	45664	322	48410	306	50553	230	51258	227	52071	300
45556	321	45670	322	48411	306	50554	230	51259	227	52075	300
45557	321	45671	322	48415	306	50555	233	51260	227	52076	300
45558	321	45672	322	48420	306	50556	230	51261	227	52077	300
45559	321	45673	322	48452	307	50557	232	51262	227	52078	300
45560	322	48001	48	48453	307	50558	232	51264	227	52101	349
45562	321	48002	48	48454	307	50559	230	51271	227	52102	349
45563	321	48004	47	48455	307	50560	230	51272	227	52103	349
45564	321	48005	47	48456	307	50562	230	51273	227	52104	349
45565	321	48006	47	48457	307	50563	230	51274	227	52105	349
45570	354	48007	47	48719	273	50564	230	51275	227	52108	348
45571	354	48008	49	48729	269	50570	230	51276	227	52109	349
45572	354	48009	49	48730	269	50571	230	51278	227	52113	349
45573	354	48010	48	48731	269	50585	233	51280	227	52114	349
45580	354	48011	48	50030	355	50585	303	51281	227	52115	349
45600	334	48013	15	50031	355	50586	233	51282	227	52116	349
45601	334	48013	48	50032	355	50586	303	51283	227	52119	348
45602	334	48015	47	50033	355	50587	233	51284	227	52126	350
45603	334	48020	46	50035	228	50587	303	51286	227	52130	280
45604	334	48021	46	50035	355	50588	233	51287	227	52135	348
45605	334	48022	46	50036	228	50588	303	51288	227	52160	349
45606	334	48030	47	50036	355	51100	228	51300	227	52161	349
45607	334	48031	48	50037	355	51102	228	51301	227	52162	349
45608	334	48032	48	50038	355	51103	228	51302	227	52163	349
45609	334	48033	48	50040	355	51104	228	51303	227	52164	349
45610	334	48034	48	50041	355	51105	228	51304	227	52168	348
45611	334	48036	47	50042	355	51106	228	51305	227	52173	348
45612	334	48037	47	50050	222	51107	228	51306	227	52175	348
45613	334	48040	48	50050	222	51108	228	51307	227	52176	348
45614	334	48041	48	50051	222	51109	228	51308	227	52185	349
45615	334	48042	48	50052	222	51110	228	51320	227	52186	349
45616	334	48043	48	50052	222	51111	228	51321	227	52187	349
45617	334	48046	46	50100	227	51120	228	51322	227	52188	349
45618	334	48046	49	50101	227	51121	228	51323	227	52189	349
45619	334	48047	46	50102	227	51122	228	51324	227	52190	349
45620	334	48047	49	50103	227	51123	228	51325	227	52191	349
45621	334	48050	49	50104	227	51124	228	51327	227	52192	349
45622	334	48051	49	50106	227	51125	228	51341	227	52193	349
45623	334	48054	49	50108	227	51126	228	51402	228	52194	349
45624	334	48055	49	50500	233	51127	228	51403	228	52195	349
45625	334	48056	49	50503	233	51130	228	51404	228	52196	349
45626	334	48057	49	50510	230	51131	228	51405	228	52197	348
45627	334	48060	49	50511	230	51132	228	51406	228	52198	348
45628	334	48061	49	50512	230	51196	228	51407	228	52202	300
45629	334	48062	49	50513	230	51197	228	51408	228	52203	300
45630	334	48063	49	50514	230	51198	228	51410	228	52204	300
45631	334	48064	49	50518	232	51199	228	51412	228	52205	300
45632	334	48065	49	50519	232	51204	227	51413	228	52206	300
45633	334	48066	49	50520	232	51205	227	51414	228	52207	300
45634	334	48067	49	50522	232	51206	227	51415	228	52208	300
45635	334	48068	49	50524	232	51207	227	51416	228	52212	300
45636	334	48070	49	50525	232	51208	227	51417	228	52213	300
45637	334	48071	49	50526	232	51209	227	51418	228	52214	300
45638	334	48072	49	50527	233	51210	227	51420	228	52215	300
45639	334	48075	49	50529	232	51211	227	51430	228	52216	300
45650	322	48076	49	50531	233	51212	227	51431	228	52217	300
45651	322	48077	49	50532	233	51220	227	51432	228	52218	300
45652	322	48080	49	50533	232	51221	227	51433	228	52220	300
45653	322	48081	49	50535	232	51222	227	51435	228	52283	300
45654	322	48085	49	50536	232	51225	227	51436	228	52284	300
45655	322	48086	49	50537	232	51226	227	51450	228	52285	300
45656	322	48087	49	50539	232	51227	227	52011	249	52286	300
45657	322	48090	49	50540	233	51241	227	52011	303	52288	300
45658	322	48091	49	50541	233	51242	227	52030	252	52305	301
45659	322	48093	49	50542	233	51243	227	52050	307	52306	301

СПИСЪК С АРТИКУЛИ

Арт. номер	Стр.	Арт. номер	Стр.	Арт. номер	Стр.	Арт. номер	Стр.	Арт. номер	Стр.	Арт. номер	Стр.
52328	301	55356	229	61003	344	61098	345	61236	217	70025	44
52331	301	55357	229	61004	344	61098	351	61240	197	70026	44
52334	301	55358	229	61005	341	61111	346	61250	351	70030	44
52391	301	55359	229	61005	351	61112	346	61251	319	70031	44
52421	301	55360	229	61006	341	61114	346	61251	351	70032	44
52424	301	55361	229	61006	351	61120	346	61252	351	70033	44
52428	301	55362	229	61007	341	61121	346	61253	351	70035	44
52456	301	55400	356	61008	341	61130	338	61254	351	70036	44
52471	301	55401	356	61009	345	61131	338	61255	351	70037	44
52600	302	55402	356	61010	341	61132	339	61256	351	70040	43
52601	302	55403	356	61012	345	61133	339	61290	346	70060	44
52602	302	55404	356	61013	344	61134	339	61291	346	70061	44
52605	302	55405	356	61014	345	61135	339	61292	346	70062	44
52610	302	55406	356	61015	341	61141	339	61293	346	70063	44
52611	248	55420	356	61018	345	61142	340	61294	318	70064	43
52612	248	55421	356	61019	344	61143	340	61295	318	70065	44
52620	302	55422	356	61020	342	61144	340	61296	318	70066	43
52625	302	55423	356	61021	342	61145	340	61297	318	70070	44
52630	302	55424	356	61022	343	61146	340	61299	356	70075	44
52635	302	55425	356	61024	343	61150	338	61300	356	70090	45
52640	302	55429	356	61025	342	61155	341	61301	356	70091	45
52645	302	55430	356	61026	342	61156	341	61302	356	70092	45
52652	302	55431	356	61027	343	61157	341	61320	197	70093	45
52656	302	55432	356	61028	345	61158	341	61321	197	70094	45
52662	302	55433	356	61029	341	61161	344	61322	197	70095	45
52666	302	55436	356	61030	340	61162	344	61323	197	70096	45
52671	302	55437	356	61031	340	61163	344	61324	197	70098	210
52694	302	55450	356	61032	340	61164	345	61325	197	81011	361
52695	302	55452	356	61033	340	61165	345	61326	197	81012	361
54008	303	55453	356	61034	340	61166	345	61327	197	81013	361
55040	229	55454	356	61035	346	61169	251	61328	197	81014	361
55050	229	55455	356	61036	346	61171	350	61329	197	81015	361
55051	229	55456	356	61038	346	61172	348	61330	197	81016	361
55060	229	55457	356	61040	346	61172	350	61331	197	81022	361
55080	229	55460	356	61042	346	61173	350	61340	317	81023	361
55100	229	55461	356	61044	345	61174	350	61341	317	81024	361
55120	229	55462	356	61045	340	61175	350	61342	317	81025	361
55140	229	55465	356	61046	340	61176	350	61343	317	81035	361
55160	229	55640	229	61047	340	61177	350	61344	317	81036	361
55180	229	55642	229	61048	340	61183	351	61345	317	81053	364
55181	229	55645	229	61050	342	61184	351	61346	317	81054	364
55200	229	55650	229	61050	351	61189	351	65062	307	81057	364
55201	229	60001	347	61051	342	61190	351	65063	307	81070	364
55220	229	60006	347	61051	351	61192	350	65064	307	81071	364
55221	229	60008	347	61052	343	61193	350	65065	307	81077	364
55240	229	60012	347	61052	351	61194	350	69900	294	81100	364
55300	229	60018	347	61053	343	61195	351	69901	294	81101	364
55315	229	60019	347	61054	343	61200	350	69902	294	81102	364
55316	229	60020	347	61056	342	61201	347	69903	294	81103	364
55317	229	60022	347	61057	342	61201	350	69904	295	81104	364
55318	229	60100	251	61058	343	61202	350	69905	294	81105	364
55319	229	60115	273	61059	343	61203	345	69906	294	81106	364
55331	229	60116	273	61060	340	61204	351	69907	295	81150	362
55332	229	60117	273	61061	340	61205	351	69908	295	81151	362
55333	229	60118	273	61062	340	61207	351	69909	295	81152	362
55334	229	60121	273	61063	340	61208	350	69910	295	81155	362
55335	229	60123	273	61067	346	61209	345	69911	295	81160	362
55336	229	60125	272	61068	346	61215	351	69912	295	81165	362
55337	229	60130	272	61069	346	61218	251	69914	294	81170	362
55339	229	60132	272	61070	346	61219	351	69917	295	81175	362
55340	229	60155	272	61077	351	61221	318	69918	294	81178	362
55341	229	60157	272	61079	351	61221	318	69919	294	81180	362
55342	229	60201	347	61079	351	61221	318	69920	295	81185	362
55350	229	60206	347	61085	319	61221	318	69923	295	81186	362
55351	229	60208	347	61088	342	61222	345	69928	295	81188	362
55352	229	60212	347	61089	342	61223	344	69930	296	81189	362
55353	229	61000	342	61090	343	61224	346	69931	296	81190	362
55354	229	61001	342	61097	344	61224	346	70020	44	81191	362
55355	229	61002	343	61097	351	61230	351	70021	44	81195	361

Арт. номер	Стр.	Арт. номер	Стр.	Арт. номер	Стр.	Арт. номер	Стр.	Арт. номер	Стр.	Арт. номер	Стр.
81196	361	81267	363	81337	363	81408	363	82103	307		
81197	361	81268	363	81338	363	81409	363	82104	307		
81200	363	81269	363	81339	363	81410	363	89775	51		
81201	363	81270	363	81340	363	81411	363	89970	51		
81202	363	81271	363	81341	363	81412	363	89973	51		
81203	363	81272	363	81342	363	81413	363	89975	51		
81204	363	81273	363	81343	363	81414	363	89980	51		
81205	363	81274	363	81344	363	81415	363	89985	51		
81206	363	81275	363	81345	363	81416	363	89987	51		
81207	363	81276	363	81346	363	81417	363	89988	51		
81208	363	81277	363	81347	363	81418	363	89989	51		
81209	363	81278	363	81348	363	81419	363	89990	51		
81210	363	81279	363	81349	363	81420	363	90070	278		
81211	363	81280	363	81350	363	81421	363	90071	278		
81212	363	81281	363	81351	363	81422	363	90072	278		
81213	363	81282	363	81352	363	81423	363	90191	56		
81214	363	81284	363	81353	363	81424	363	90192	57		
81215	363	81285	363	81354	363	81425	363	18610A	150		
81216	363	81286	363	81355	363	81426	363	18611A	150		
81217	363	81287	363	81356	363	81427	363	18612A	150		
81218	363	81288	363	81357	363	81428	363	18613A	150		
81219	363	81289	363	81358	363	81429	363	18614A	150		
81220	363	81290	363	81359	363	81430	363	18615A	150		
81221	363	81291	363	81360	363	81431	363	18632A	147		
81222	363	81292	363	81361	363	81432	363	18633A	147		
81223	363	81293	363	81362	363	81433	363	18636A	147		
81224	363	81294	363	81363	363	81434	363	18637A	147		
81225	363	81295	363	81364	363	81435	363	18638A	147		
81226	363	81296	363	81365	363	81436	363	18827A	147		
81227	363	81297	363	81366	363	81437	363	18828A	147		
81228	363	81298	363	81367	363	81438	363	18830A	147		
81229	363	81299	363	81370	363	81439	363	18831A	147		
81230	363	81300	363	81371	363	81440	363	81011A	361		
81231	363	81301	363	81372	363	81441	363	81011F	361		
81232	363	81302	363	81373	363	81442	363	81011G	361		
81233	363	81303	363	81374	363	81443	363	81011H	361		
81234	363	81304	363	81375	363	81444	363	81011R	361		
81235	363	81305	363	81376	363	81445	363	M90203	365		
81236	363	81306	363	81377	363	81447	363	M90204	365		
81237	363	81307	363	81378	363	81448	363	M90205	365		
81238	363	81308	363	81379	363	81449	363	M90206	365		
81239	363	81309	363	81380	363	81450	363	M90207	365		
81240	363	81310	363	81381	363	81451	363	M90210	365		
81241	363	81311	363	81382	363	81452	363	M90220	365		
81242	363	81312	363	81383	363	81453	363	M90221	365		
81243	363	81313	363	81384	363	81454	363	M90222	365		
81244	363	81314	363	81385	363	81455	363	M90400	365		
81245	363	81315	363	81386	363	81456	363	M90403	365		
81246	363	81316	363	81387	363	81457	363	M90519	365		
81247	363	81317	363	81388	363	81458	363				
81248	363	81318	363	81389	363	81459	363				
81249	363	81319	363	81390	363	81460	363				
81250	363	81320	363	81391	363	81461	363				
81251	363	81321	363	81392	363	81462	363				
81252	363	81322	363	81393	363	81463	363				
81253	363	81323	363	81394	363	81466	363				
81254	363	81324	363	81395	363	81467	363				
81255	363	81325	363	81396	363	81468	363				
81256	363	81326	363	81397	363	81469	363				
81257	363	81327	363	81398	363	81470	363				
81258	363	81328	363	81399	363	81471	363				
81259	363	81329	363	81400	363	81472	363				
81260	363	81330	363	81401	363	81473	363				
81261	363	81331	363	81402	363	81486	363				
81262	363	81332	363	81403	363	81600	364				
81263	363	81333	363	81404	363	81603	364				
81264	363	81334	363	81405	363	82100	307				
81265	363	81335	363	81406	363	82101	307				
81266	363	81336	363	81407	363	82102	307				

ЛЕГЕНДА НА ИЗПОЛЗВАНИТЕ СИМВОЛИ

· СПЕЦИФИКАЦИИ НА ПРОДУКТА



СПЕЦИФИКАЦИИ НА ПРИЛОЖЕНИЕТО

- дърво
- керамика
- пластмаса
- алуминий
- мед
- камък
- стъкло
- зидария
- хартия
- метал
- комбиниран
- плочки
- неръждаема стомана
- измазване
- дърво с винт, пирони
- гипсокартон
- за пробиване на материали с якост на опън до ...

- S2** · състав на продукта - стомана S2
- HSS** · състав на продукта - високоскоростна стомана
- Cr-Mo** · състав на продукта - хром-молибденова стомана
- CrV** · състав на продукта - хром-ванадиева стомана
- INOX** · състав на продукта - неръждаема стомана
- NYLON** · найлонова дръжка
- TEFLON** · тефлоново покритие
- Zn** · Zn покритие
- TiN** · TiN покритие
- HRC 58-61** · HRC -твърдост на материала
- 40% PES** · съдържание на материала в проценти - 40% полиестер
- PES** · съдържание на материала - полиестер
- DIAMANT** · диамантено покритие
- MAGNETIC** · продуктът или част от него има магнитни свойства

- SDS+** **SDS MAX** **M14** · система за затягане
- 72T** **36T** · брой зъби на тресчотка
- 1/2"** **3/4"** **1/4"** · размер на монтаж
- 27 dB** · информация относно нивото на шум
- DIN 3113** **IP 54** · стандарт
- 32x** · брой артикули в комплект
- II. class** **III. class** · клас на точност
- MINUS** · подходящо за ниски температури
- ERGO HANDLE** · ергономичен дизайн
- HOBBY** · хоби
- 2x AAA** · тип и брой на батериите
- UV STABLE** · UV защита
- RUBBER ENDS** · удароустойчиви гумени накрайници

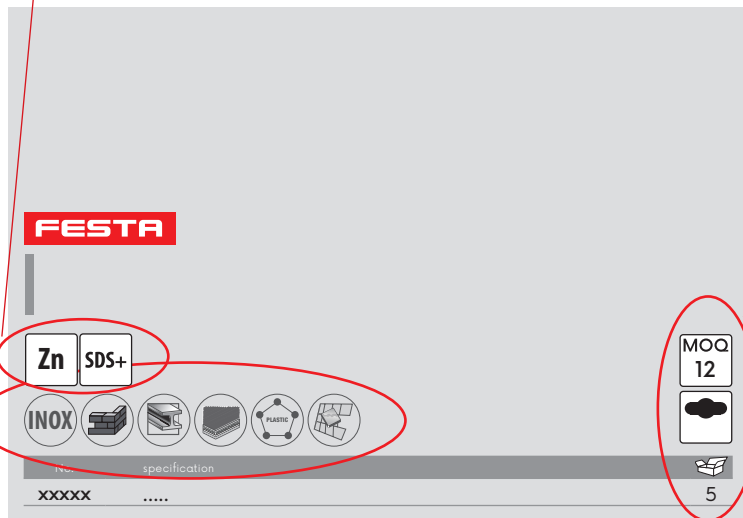

· ОПАКОВКА И СКЛАД

- BOX** · опаковани в кутия
- EVROSLLOT** · еврослот
- MOQ 12** · минимално количество за поръчка
- 5** · брой парчета в опаковката

AQUATIC FESTA A ROSA СПЕЦИФИКАЦИЈЕ

регулируеми модели на спрей ·

- минимално и максимално налягане · **2bar min** **4bar max**
- максимален дебит на водата · **Max** **27L/min**
- поливна площ · **318 m²**
- размер на резбата на адаптера · **1/2"**
- диаметър на маркуча · **1/2"**



20

25

26



ПРОФЕСИОНАЛНИ  ИНСТРУМЕНТИ



festatools



#festatools



festatools



www.festa.tools

HORIZONT.

FESTA
POWER X TOOLS

FESTA
AQUATIC

ROSA KOMELON.

KDS

Stahlberg

SUPER PRO

Lescha

