



# FESTA

PROFESIONÁLNÍ X NÁŘADÍ



20  
25  
26

**FESTA**  
POWER X TOOLS

Elektronářadí a AKU nářadí s využitím kvalitních komponentů, nejnovějších technologií a současných trendů v tomto sortimentu

**FESTA**

Značka profesionálního ručního nářadí pro stavbu dílny i zahradu

**FESTA**  
INDUSTRY

Prémiová řada vybraných nástrojů a ručního nářadí nejvyšší kvality navržené pro náročné pracovní podmínky, kde je kladen důraz na výkon.

**FESTA**  
AQUATIC

Profesionální zavlažovací sortiment s moderním designem, kompatibilní s řadou produktů Rosa

**HORIZONT**  
MASTER

Značka profesionálních vodováh

**HORIZONT**

Značka profesionálních vodováh a kvalitních stahovacích latí

**ROSA**

Kvalitního zavlažovací systémy a zahradní nářadí

**KDS**<sup>®</sup>

Japonské nože s dlouholetou tradicí

**KOMELON**<sup>®</sup>

Profesionální měřidla



Profesionální řezačky obkladů



Výrobce kvalitních zahradních nůžek

**Lescha**

Profesionální stavební míchačky

**Stahlberg**

Profesionální šroubovací nástavce



Značka profesionálních pil

## AKU A ELEKTRICKÉ NÁŘADÍ

2 - 53

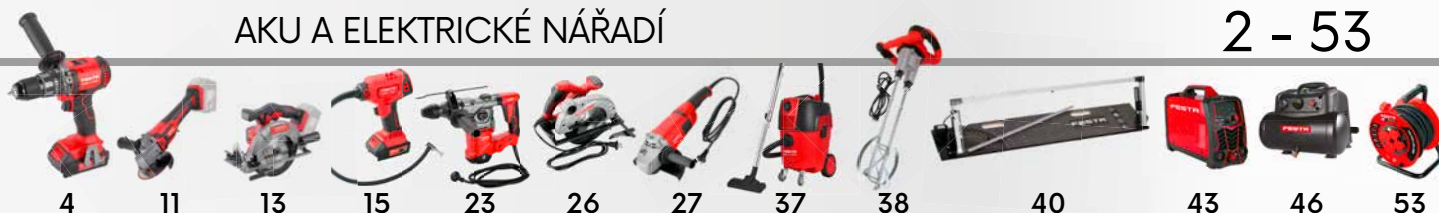

## ŘEZNÉ A BRUSNÉ NÁSTROJE

54 - 93



## DÍLENSKÉ NÁŘADÍ

94 - 205



## DÍLNA

206 - 241



## STAVEBNÍ NÁŘADÍ

242 - 307

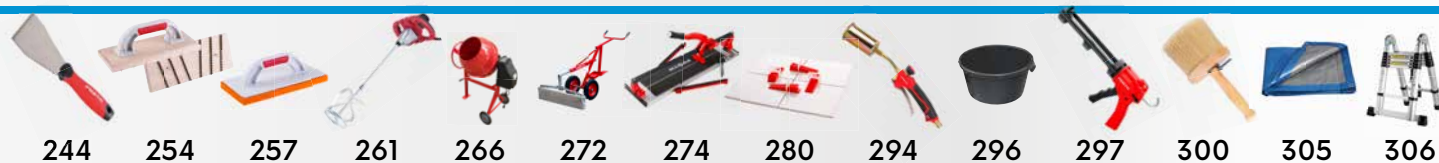

## ZAHRADNÍ NÁŘADÍ

308 - 359



## FESTA

360 - 365



## REJSTŘÍK

366 - 380



VRTAČKY

4



PŘÍKLEPOVÉ VRTAČKY

9



SPONKOVAČKA

10



ÚHLOVÉ BRUSKY

11



BRUSKY

12



KOTOUČOVÁ PILA

13



PNEU KOMPRESOR

15

VIBRÁTOR  
S PŘÍSAVKOU NA DLAŽBU

16



VYTLAČOVACÍ PISTOLE

17



LED SVĚTLO

17



RÁDIO DAB+ / FM / BT

18



VRTACÍ A SEKACÍ KLADIVA

23



KOTOUČOVÁ PILA

26



ÚHLOVÉ BRUSKY

27



BRUSKA NA SÁDROKARTON

36



VYSAVAČE

37



STAVEBNÍ MÍCHADLA

38



VYSOKOTLAKÉ ČISTIČE

39



ŘEZAČKY POLYSTYRENU

40

SVÁŘECÍ INVERTOR  
A PŘÍSLUŠENSTVÍ

43



POLYFUZNÍ SVÁŘEČKY

45

KOMPRESORY  
A PŘÍSLUŠENSTVÍ

46



HORKOVZDUŠNÉ PISTOLE

50



TOPIDLA

52



PRODLUŽOVACÍ KABELY

53



ELEKTRICKÉ  
A AKU NÁŘADÍ

2 - 53



**FESTA**  
POWER X TOOLS

**BRUSHLESS** **SHARE** **Li-ion**  
**20V** *technology*

otáčky  
0-550 min<sup>-1</sup>  
0-2000 min<sup>-1</sup>

hmotnost  
s baterií 2,0 Ah **1,8 kg**  
s baterií 4,0 Ah **2,1 kg**

kroučící moment  
**80 Nm**

skličidlo  
**2 - 13 mm**



Sada obsahuje:  
- vrtačku  
- baterii 2,0 Ah  
- baterii 4,0 Ah  
- nabíječku 2,4 A  
- přídatnou rukojeť  
- kufr



**FESTA**  
POWER X TOOLS

## VRTAČKA AKU PŘÍKLEPOVÁ



Č.p.  
28000

specifikace

2

**BRUSHLESS SHARE 20V** *Li-ion technology*



volba režimu  
volba síly kroučícího momentu

otáčky  
0-550 min<sup>-1</sup>  
0-2000 min<sup>-1</sup>

hmotnost  
s baterií 2,0 Ah **1,8 kg**  
s baterií 4,0 Ah **2,1 kg**

kroučící moment  
**80 Nm**

sklíčidlo  
**2 – 13 mm**

Sada obsahuje:  
- vrtačku  
- baterii 2,0 Ah  
- nabíječku 2,4 A  
- přídatnou rukojeť  
- kufr



přídatná rukojeť

rychloupínací  
sklíčidlová  
hlava

ergonomická pogumovaná  
rukojeť pro pohodlný  
a bezpečný úchop

LED osvětlení

aretače baterie



přepínač rychlosti

přepínač  
směru otáčení

háček pro  
zavěšení



**VRTAČKA AKU PŘÍKLEPOVÁ**



Č.p.  
28001

specifikace

2

**BRUSHLESS SHARE 20V**



volba režimu  
volba síly kroučícího momentu

otáčky  
0-550 min<sup>-1</sup>  
0-2000 min<sup>-1</sup>

hmotnost  
bez baterie  
**1,4 kg**

kroučící moment  
**80 Nm**

sklíčidlo  
**2 – 13 mm**

**Doporučené příslušenství**

**SHARE 20V** *Li-ion technology*

baterie\* 2 Ah - 28080  
4 Ah - 28081  
8 Ah - 28083

nabíječka\* 2,4 A - 28085  
4,0 A - 28086



přídatná rukojeť

rychloupínací  
sklíčidlová  
hlava

ergonomická pogumovaná  
rukojeť pro pohodlný  
a bezpečný úchop

LED osvětlení



přepínač rychlosti

přepínač  
směru otáčení

háček pro zavěšení



**VRTAČKA AKU PŘÍKLEPOVÁ**



\*baterie a nabíječka není součástí balení

Č.p.  
28002

specifikace

5

SHARE  
20VLi-ion  
technology

otáčky  
0-500 min<sup>-1</sup>  
0-1800 min<sup>-1</sup>

hmotnost  
s baterií 2,0 Ah  
1,7 kg

kroučící moment  
45 Nm

sklíčidlo  
2 - 13 mm

Sada obsahuje:

- vrtačku
- 2x baterii 2,0 Ah
- nabíječku 2,4 A
- kufr
- unášec a bity:
- ⊖ S5, S6 x 25 mm
- ⊕ PH1, PH2 x 25 mm
- ✦ PZ1, PZ2 x 25 mm
- vrtáky HSS  
2-2,5-3-4-5-6 mm

volba režimu  
volba síly kroučícího momenturychloupínací  
sklíčidlová  
hlava

přepínač rychlosti

přepínač  
směru otáčeníergonomická pogumovaná  
rukojeť pro pohodlný  
a bezpečný úchop

LED osvětlení

aretace baterie

háček  
pro zavěšeníFESTA  
POWER X TOOLS

## VRTAČKA AKU PŘÍKLEPOVÁ



Č.p. specifikace

28003

3

SHARE  
20V

otáčky  
0-550 min<sup>-1</sup>  
0-2000 min<sup>-1</sup>

hmotnost  
bez baterie  
1,4 kg

kroučící moment  
45 Nm

sklíčidlo  
2 - 13 mm

Doporučené příslušenství

SHARE 20V Li-ion technologie

baterie\* 2 Ah - 28080  
4 Ah - 28081  
8 Ah - 28083

nabíječka\* 2,4 A - 28085  
4,0 A - 28086

volba režimu  
volba síly kroučícího momenturychloupínací  
sklíčidlová  
hlava

přepínač rychlosti

ergonomická pogumovaná  
rukojeť pro pohodlný  
a bezpečný úchop

LED osvětlení

háček  
pro zavěšeníFESTA  
POWER X TOOLS

## VRTAČKA AKU PŘÍKLEPOVÁ



\*baterie a nabíječka není součástí balení

Č.p. specifikace

28004

5

**SHARE**  
**20V** *Li-ion*  
*technology*

otáčky  
0-350 min<sup>-1</sup>  
0-1300 min<sup>-1</sup>

hmotnost  
s baterií 2,0 Ah  
1,3 kg

kroučící moment  
28 Nm

sklíčidlo  
1 – 10 mm

Sada obsahuje:

- vrtačku
- 2x baterii 2,0 Ah
- nabíječku 2,4 A
- kufr
- unášec a bity:
- ⊖ S5, S6 x 25 mm
- ⊕ PH1, PH2 x 25 mm
- ✦ PZ1, PZ2 x 25 mm
- vrtáky HSS  
1,5-2,5-3-4-5-6 mm



volba režimu  
nastavení kroučícího momentu

rychloupínací  
sklíčidlová hlava

přepínač rychlosti

přepínač  
směru otáčení

ergonomická pogumovaná  
rukojeť pro pohodlný  
a bezpečný úchop

LED osvětlení

aretače baterie

háček  
pro zavěšení



**FESTA**  
POWER X TOOLS

**VRTAČKA AKU**



Č.p. specifikace

28005

3

**SHARE**  
**20V**

otáčky  
0-350 min<sup>-1</sup>  
0-1300 min<sup>-1</sup>

hmotnost  
bez baterie  
0,9 kg

kroučící moment  
28 Nm

sklíčidlo  
1 – 10 mm

Doporučené příslušenství

- SHARE**  
**20V** *Li-ion*  
*technology*
- baterie\* 2 Ah - 28080
- baterie\* 4 Ah - 28081
- baterie\* 8 Ah - 28083
- nabíječka\* 2,4 A - 28085
- nabíječka\* 4,0 A - 28086



volba režimu  
nastavení kroučícího momentu

rychloupínací  
sklíčidlová hlava

přepínač rychlosti

přepínač  
směru otáčení

ergonomická pogumovaná  
rukojeť pro pohodlný  
a bezpečný úchop

LED osvětlení

háček  
pro zavěšení



**FESTA**  
POWER X TOOLS

**VRTAČKA AKU**



\*baterie a nabíječka není součástí balení

Č.p. specifikace

28006



5

**Li-ion**  
technology

otáčky  
**0-350 min<sup>-1</sup>**  
**0-1300 min<sup>-1</sup>**

hmotnost  
s baterií 1,5 Ah  
**1 kg**

kroučící moment  
**20 Nm**

sklíčidlo  
**1 – 10 mm**

Sada obsahuje:

- vrtačku
- 2x baterii 12 V | 1,5 Ah
- nabíječku 12 V | 2,4 A
- kufr
- unášec a bity:
- ⊖ S5, S6 x 25 mm
- ⊕ PH1, PH2 x 25 mm
- ⊕ PZ1, PZ2 x 25 mm
- vrtáky HSS  
1,5-2,5-3-4-5-6 mm

volba režimu  
nastavení kroučícího momenturychloupínací  
sklíčidlová hlava

přepínač rychlosti

LED osvětlení

indikátor nabití baterie

ergonomická pogumovaná  
rukojeť pro pohodlný  
a bezpečný úchoppřepínač  
směru otáčení

baterie

**FESTA**  
POWER X TOOLS**VRTAČKA AKU**

Č.p. specifikace

28007

5

**Li-ion**  
technology

otáčky  
bez zatížení  
**200 min<sup>-1</sup>**

hmotnost  
s baterií 1,5 Ah  
**0,4 kg**

maximální kroučící  
moment  
**3 Nm**

unášec  
nástroje  
**1/4" šestihran**

Sada obsahuje:

- šroubovák
- nabíječku 5 V | 0,5 A
- unášec a bity:
- ⊖ S5 x 50 mm
- ⊕ PH1 x 50 mm
- ⊕ PH2 x 50 mm
- ⊕ H5 x 50 mm
- ⊕ T20 x 50 mm

rychloupínací hlava  
1/4" s pojistkounastavení  
kroučícího momentu

indikátor nabití baterie

aretace nastavení  
polohy rukojeti

LED osvětlení

přepínač směru  
otáčeníergonomická pogumovaná  
rukojeť pro pohodlný  
a bezpečný úchop

LED svítlna

**FESTA**  
POWER X TOOLS**ŠROUBOVÁK AKU**

Č.p. specifikace

28008

10

**SHARE  
20V**

otáčky  
bez zatížení  
**0-2000 min<sup>-1</sup>**

hmotnost  
bez baterie  
**1,2 kg**

kroučící moment  
**150 Nm**

počet rázů  
**0-3000 bpm**

rychloupínací hlava  
1/4" s pojistkou



volitelný směr otáčení

ergonomická pogumovaná  
rukojeť pro pohodlný  
a bezpečný úchop

LED osvětlení

háček pro zavěšení

**Doporučené příslušenství**

**SHARE  
20V**  
*Li-ion  
technology*

baterie\* 2 Ah - 28080  
4 Ah - 28081  
8 Ah - 28083  
nabíječka\* 2,4 A - 28085  
4,0 A - 28086



**FESTA**  
POWER X TOOLS

**UTAHOVÁK AKU RÁZOVÝ**

max 150 Nm | 0-2000min<sup>-1</sup> | 0-3000bpm | 1/4" | LED | 1,2 kg

\*baterie a nabíječka není součástí balení



Č.p. 28021

specifikace

5

**SHARE  
20V**

otáčky  
bez zatížení  
**I.0-300 min<sup>-1</sup>**  
**II.0-1000 min<sup>-1</sup>**

hmotnost  
bez baterie  
**1,7 kg**

BMP / příklep  
**0-5000 / 1,2 J**

úchyt  
**SDS+**

přepínání režimu vrtání  
(s/bez příklepu)

hloubkový doraz

přepínač rychlosti

přepínač  
směru otáčení



SDS upínací  
hlava nástroje

**Doporučené příslušenství**

**SHARE  
20V**  
*Li-ion  
technology*

baterie\* 2 Ah - 28080  
4 Ah - 28081  
8 Ah - 28083  
nabíječka\* 2,4 A - 28085  
4,0 A - 28086



**FESTA**  
POWER X TOOLS

**KLADIVO VRTACÍ AKU**

1.0-300 min<sup>-1</sup> / II.0-1000 min<sup>-1</sup> | 0-5000 bpm | 1,2J | SDS+ | 1,7 kg

\*baterie a nabíječka není součástí balení



MAX Ø

beton - Ø 20 mm  
kov - Ø 10 mm  
dřevo - Ø 20 mm

Č.p. 28025

specifikace

2

## SHARE 20V

frekvence nastřelování  
**60-100 min<sup>-1</sup>**

max. délka hřebíků/spon  
**30 mm**  
**tvrdé materiály**

max. délka hřebíků/spon  
**50 mm**  
**měkké materiály**

hmotnost bez baterie  
**2,7 kg**

pojistka

LED signalizace poruch



ergonomická pogumovaná rukojeť pro pohodlný a bezpečný úchop

pojistka provozního spínače

háček pro zavěšení

přepínač režimu nastřelování

Doporučené příslušenství

**SHARE 20V Li-ion technology**

baterie\* 2 Ah - 28080  
4 Ah - 28081  
8 Ah - 28083

nabíječka\* 2,4 A - 28085  
4,0 A - 28086



**Hřebíky**

**23930** Hřebík nastřelovací 30 mm, 2000 ks  
**23931** Hřebík nastřelovací 40 mm, 2000 ks  
**23932** Hřebík nastřelovací 50 mm, 2000 ks

**Spony**

**23935** Spona nastřelovací 30 mm, 2000 ks  
**23936** Spona nastřelovací 40 mm, 2000 ks

Vhodné typy hřebíků a spon:

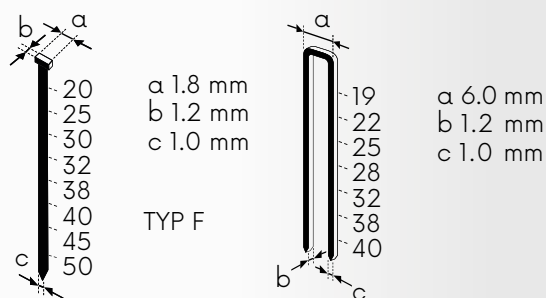

LED osvětlení

ukazatel prázdného zásobníku



pojistka

regulace síly úderu



pojízdňý kryt zásobníku

pojistka krytu zásobníku

**FESTA**  
POWER X TOOLS

## HŘEBÍKOVAČKA – SPONKOVAČKA AKU



\*baterie a nabíječka není součástí balení



**BRUSHLESS SHARE 20V**



otáčky bez zatížení  
**8500 min<sup>-1</sup>**



hmotnost bez baterie  
**1,6 kg**

maximální tloušťka řezaného materiálu  
**15 mm**

maximální průměr kotouče  
**125 mm**

**SHARE 20V**  
*Li-ion technology*

Doporučené příslušenství

baterie*	2 Ah - 28080	
	4 Ah - 28081	
	8 Ah - 28083	
nabíječka*	2,4 A - 28085	
	4,0 A - 28086	



**BRUSKA AKU**

 8500 min <sup>-1</sup>	 max 125mm	 M14	 L R	 1,6
---	---	--	--	--

\*baterie a kotouč není součástí balení

Č.p. 28030

specifikace



4

větrací otvory motoru

ergonomická pogumovaná rukojeť pro pohodlný a bezpečný úchop

aretace otáčení

pojistka provozního spínače

rychloupínací mechanismus ochranného krytu

upínací matice kotouče



**SHARE 20V**



otáčky bez zatížení  
**8000 min<sup>-1</sup>**



hmotnost bez baterie  
**1,6 kg**

maximální tloušťka řezaného materiálu  
**15 mm**

maximální průměr kotouče  
**115 mm**

**SHARE 20V**  
*Li-ion technology*

Doporučené příslušenství

baterie*	2 Ah - 28080	
	4 Ah - 28081	
	8 Ah - 28083	
nabíječka*	2,4 A - 28085	
	4,0 A - 28086	



**BRUSKA AKU**

 8000 min <sup>-1</sup>	 max 115mm	 M14	 L R	 1,6
--	--	---	---	---

\*baterie a kotouč není součástí balení

Č.p. 28032

specifikace



4

ergonomická pogumovaná rukojeť pro pohodlný a bezpečný úchop

aretace otáčení

pojistka provozního spínače

rychloupínací mechanismus ochranného krytu

upínací matice kotouče



## SHARE 20V

otáčky  
bez zatížení  
**10000 min<sup>-1</sup>**

hmotnost  
bez baterie  
**1 kg**

excentricita  
kotouče  
**5 mm**

průměr  
kotouče  
**125 mm**

## SHARE 20V Li-ion technology

Doporučené příslušenství

2 Ah - 28080

baterie\* 4 Ah - 28081

8 Ah - 28083

nabíječka\* 2,4 A - 28085

4,0 A - 28086



**FESTA**  
POWER X TOOLS

### BRUSKA AKU EXCENTRICKÁ



\*baterie a nabíječka není součástí balení



Č.p. specifikace  
28040



4



## SHARE 20V

počet kmitů  
bez zatížení  
**5000-15000 min<sup>-1</sup>**

hmotnost  
bez baterie  
**1 kg**

regulace otáček



## SHARE 20V Li-ion technology

Doporučené příslušenství

2 Ah - 28080

baterie\* 4 Ah - 28081

8 Ah - 28083

nabíječka\* 2,4 A - 28085

4,0 A - 28086



**FESTA**  
POWER X TOOLS

### BRUSKA AKU MULTIFUNKČNÍ



\*baterie a nabíječka není součástí balení

Č.p. specifikace  
28045



4

SHARE  
20Vergonomická pogumovaná rukojeť  
pro pohodlný a bezpečný úchop

pojistka provozního spínače

kryt kotouče

nastavení úhlu  
sklonu řezu  
45-90 stupňůpřipojení  
externího  
odsávání

základna

hřídel 16 mm

otáčky  
bez zatížení  
**3650 min<sup>-1</sup>**nastavitelný  
úhel sklonu řezu  
**45-90 stupňů**max. průměr  
kotouče  
**165 mm**  
(ø16 mm)max. prořez  
**50 mm**\* při úhlu 90 stupňů  
s kotoučem ø165 mmstupnice  
hloubky řezu

aretace otáčení

nastavení hloubky řezu

SHARE  
20V  
Li-ion  
technology

Doporučené příslušenství

baterie\* 2 Ah - 28080

4 Ah - 28081

8 Ah - 28083

nabíječka\* 2,4 A - 28085

4,0 A - 28086

FESTA  
POWER X TOOLS

## PILA AKU KOTOUČOVÁ

Sada obsahuje:

- kotoučovou pilu
- doraz bočního vedení
- montážní inbus
- kotouč ø 165 x 2,8/2,0 x 20 mm 24T (22314)



vodící lišta



22314

Č.p. specifikace

28035



2

**SHARE**  
**20V**

počet zdvihů plátku  
**0-2400 min<sup>-1</sup>**

hmotnost bez baterie  
**1,8 kg**

max. úhel zkosení řezu  
**45 stupňů**

max. řezaný profil  
**ocel: 6 mm**  
**dřevo: 80 mm**

**Doporučené příslušenství**

**SHARE**  
**20V**

**Li-ion**  
technology

baterie\* 2 Ah - 28080  
4 Ah - 28081  
8 Ah - 28083  
nabíječka\* 2,4 A - 28085  
4,0 A - 28086



**FESTA**  
POWER X TOOLS

**PILA AKU PŘÍMOČARÁ**



\*baterie a nabíječka není součástí balení

ergonomická pogumovaná rukojeť pro pohodlný a bezpečný úchop

pojistka provozního spínače

nastavení předkmitu

osvětlení

páčka aretace sklonu

aretace lišty

základna

vodící lišta



zkosení řezu  
0°  
45° 45°



28050

specifikace

4

**SHARE**  
**20V**



počet kmitů bez zatížení  
**0-3000 min<sup>-1</sup>**

hmotnost bez baterie  
**1,7 kg**

max. řezná tloušťka  
**dřevo: 100 mm**  
**ocel: 5 mm**  
**hliník/měď: 20 mm**

**Doporučené příslušenství**

**SHARE**  
**20V**

**Li-ion**  
technology

baterie\* 2 Ah - 28080  
4 Ah - 28081  
8 Ah - 28083  
nabíječka\* 2,4 A - 28085  
4,0 A - 28086



**FESTA**  
POWER X TOOLS

**PILA AKU OCASKA**



\*baterie a nabíječka není součástí balení

pojistka provozního spínače



ergonomická pogumovaná rukojeť pro pohodlný a bezpečný úchop

rychloupínání pilového plátku



28055

specifikace

4

**SHARE  
20V**

max. tlak  
**8,2 bar**

manometr  
psi, bar,  
kgf/cm<sup>2</sup>, kPa

hadice  
Ø 10,5 x 600 mm

napětí  
**20 V**

podsvícený display  
manometru



ergonomická  
pogumovaná  
rukojeť pro  
pohodlný a  
bezpečný úchop

rychloupínací  
spona na huštění  
pneumatik

napájecí adaptér  
do autozásuvky 3 m



Sada obsahuje:  
- kompresor  
- adaptér do autozásuvky  
- 3x adaptéry pro nafukování

hadice  
Ø 10,5 x 600 mm



LED osvětlení



**Doporučené příslušenství**

**SHARE  
20V**  
*Li-ion  
technology*

baterie\* 2 Ah - 28080  
4 Ah - 28081  
8 Ah - 28083  
nabíječka\* 2,4 A - 28085  
4,0 A - 28086



**FESTA**  
POWER X TOOLS

**KOMPRESOR AKU**

\*baterie a nabíječka není součástí balení

Č.p. Specifikace

28075

48013 **NEW** adaptéry ke kompresoru



1

1

**NEW**

horizontální poloha  
110 kg

vertikální poloha  
80 kg

Ø 220 mm

USB-C

**FESTA**  
POWER X TOOLS

**PŘÍSAVKA AKU**

220 mm

80 kg

110 kg

ROUGH SURFACE

USB-C

Li-ion 3.6V  
2Ah

Č.p. Specifikace

36326

USB - C

Li-ion technology

1

## SHARE 20V

max. nosnost  
60 kg

vibrace  
12 stupňů,  
3500 - 8500 r/min

hmotnost  
3 kg

napětí  
20 V



ergonomická  
pogumovaná  
rukojeť pro  
pohodlný a  
bezpečný úchop



display



aretace



přísavek Ø 125 mm



Doporučené příslušenství

**SHARE**  
**20V**  
Li-ion  
technology

baterie\*  
2 Ah - 28080  
4 Ah - 28081  
8 Ah - 28083

nabíječka\*  
2,4 A - 28085  
4,0 A - 28086



Sada obsahuje:  
- vibrační přísavek  
- baterii 2,0 Ah (pouze 36328)  
- nabíječku (pouze 36328)  
- kufr



**FESTA**  
POWER X TOOLS

**VIBRÁTOR  
S PŘÍSAVKOU NA DLAŽBU AKU**

Č.p.	Specifikace	
36328	s baterií 2Ah a nabíječkou	1
36329	bez baterie a nabíječky	1

**SHARE  
20V**

rychlost  
vytlačování  
0-8,7 mm/s

hmotnost  
1,7 kg

vytlačovací  
síla  
6500 N

napětí  
20 V

velikost kartuše 310 ml



ergonomická  
pogumovaná  
rukojeť pro  
pohodlný a  
bezpečný úchop

plynulá regulace  
rychlosti vytlačování

LED osvětlení



Doporučené příslušenství

**SHARE  
20V  
Li-ion  
technology**

baterie\* 2 Ah - 28080  
4 Ah - 28081  
8 Ah - 28083

nabíječka\* 2,4 A - 28085  
4,0 A - 28086



**PISTOLE VYTLAČOVACÍ AKU**

\*baterie a nabíječka není součástí balení

Č.p.	Specifikace
28060	



1



**KARTUŠE NÁHRADNÍ NA TMELY**

pro 28060

Č.p.	Specifikace
28061	600 ml



1

**SHARE  
20V**



barevná teplota  
5000 K

hmotnost  
bez baterie  
0,9 kg

světelný tok  
2000 lm (100%)

výkon LED  
20W

**SHARE  
20V  
Li-ion  
technology**

Doporučené příslušenství

baterie\* 2 Ah - 28080  
4 Ah - 28081  
8 Ah - 28083

nabíječka\* 2,4 A - 28085  
4,0 A - 28086



nastavení intenzity svícení  
50%, 100%



**LED SVĚTLA AKU STAVEBNÍ**



\*baterie a nabíječka není součástí balení

Č.p.	specifikace
28065	



nastavení otočné hlavy 360°



2

## SHARE 20V

příjem  
DAB+ / FM / BT

výkon  
2x 15 W

voděodolnost  
IP54

napětí  
20 V



USB pro nabíjení 5V

napájení **SHARE 20V**

FM anténa



barevný display

### Doporučené příslušenství

**SHARE**  
**20V**

Li-ion  
technology

baterie\*

2 Ah - 28080

4 Ah - 28081

8 Ah - 28083



nabíječka\*

2,4 A - 28085

4,0 A - 28086



vstup jack 3,5 mm

stereo reproduktory



napájení - adaptér 230V



**FESTA**  
POWER X TOOLS

## RÁDIO AKU DAB+ / FM / BT

- stereo
- příjem DAB+ / FM
- externí vstup Bluetooth V5.0 / AUX IN 3,5 mm jack
- voděodolnost IP54
- 30 paměťových míst (30 pro DAB / 30 pro FM)
- USB pro nabíjení
- barevný display 2,4"
- výkon 2x 15 W
- 20 V / 1,3 A
- napájecí adaptér

\*baterie a nabíječka není součástí balení

Č.p. Specifikace

28076



**SHARE**  
**20V**



NABÍJEČKA 20 V | 2,4 A

Č.p. specifikace  
28085 220 – 240 V, 50 – 60 Hz, 70 W



20

**SHARE**  
**20V**



NABÍJEČKA 20 V | 4,0 A

Č.p. specifikace  
28086 \*220 – 240 V, 50 – 60 Hz, 105 W



20

**SHARE** *Li-ion technology*  
**20V**



indikátor nabití baterie

BATERIE 20 V | 2,0 Ah

20V	2,0 Ah	Li-ion	KG 0,4
-----	--------	--------	--------

Č.p. specifikace  
28080



20

**SHARE** *Li-ion technology*  
**20V**



indikátor nabití baterie

BATERIE 20 V | 4,0 Ah

20V	4,0 Ah	Li-ion	KG 0,7
-----	--------	--------	--------

Č.p. specifikace  
28081



20

**SHARE** *Li-ion technology*  
**20V**



indikátor nabití baterie

BATERIE 20 V | 8,0 Ah

20V	8,0 Ah	Li-ion	KG 1,0
-----	--------	--------	--------

Č.p. specifikace  
28083



20

**NEW**

**SHARE**  
**20V** *Li-ion*  
*technology*

28080



28085



ZVÝHODNĚNÁ  
**CENA**

**FESTA**  
POWER X TOOLS

### SADA BATERIE + NABÍJEČKA

28080 - Baterie do AKU nářadí FESTA SHARE20V 2,0 Ah  
28085 - Nabíječka FESTA SHARE20V 2,4 A

Č.p. specifikace

28090

1

**SHARE**  
**20V** *Li-ion*  
*technology*

28004

str. 6

28025  
str. 9

37330

28030  
str. 12**BRUSHLESS**

ZVÝHODNĚNÁ  
**CENA**  
+ TAŠKA ZDARMA

**FESTA**  
POWER X TOOLS

### AKU SET S TAŠKOU SADA 3+3

28004 - Vrtačka AKU s příklepem FESTA SHARE20V  
28025 - Kladivo vrtací AKU FESTA SDS+ SHARE20V  
28030 - Bruska úhlová AKU FESTA "BRUSHLESS" SHARE20V 125 mm  
28080 - Baterie do AKU nářadí FESTA SHARE20V 2,0 Ah  
28081 - Baterie do AKU nářadí FESTA SHARE20V 4,0 Ah  
28086 - Nabíječka FESTA SHARE20V 4,0 A

28080  
str. 1828081  
str. 1828086  
str. 18

Č.p. specifikace

28102

1

**BRUSHLESS** **SHARE**  
**20V** *Li-ion*  
*technology*

28002  
str. 5

37330

28030  
str. 12

ZVÝHODNĚNÁ  
**CENA**  
+ TAŠKA ZDARMA

**FESTA**  
POWER X TOOLS

### AKU SET S TAŠKOU SADA 2+3

28002 - Vrtačka AKU s příklepem FESTA SHARE20V  
28030 - Bruska úhlová AKU FESTA "BRUSHLESS" SHARE20V 125 mm  
28080 - Baterie do AKU nářadí FESTA SHARE20V 2,0 Ah  
28081 - Baterie do AKU nářadí FESTA SHARE20V 4,0 Ah  
28086 - Nabíječka FESTA SHARE20V 4,0 A

28080  
str. 1828081  
str. 1828086  
str. 18

Č.p. specifikace

28103

1

**SHARE**  
**20V** *Li-ion*  
*technology*

28004  
str. 6



28032  
str. 12



28055  
str. 15



ZVÝHODNĚNÁ  
**CENA**  
+TAŠKA ZDARMA

28035  
str. 14



37330



28040  
str. 13



**FESTA**  
POWER X TOOLS

**AKU SET S TAŠKOU SADA 5+3**

- 28004 - Vrtačka AKU s příklepem FESTA SHARE20V
- 28032 - Bruska úhlová AKU FESTA SHARE20V 115 mm
- 28035 - Pila kotoučová AKU FESTA SHARE20V 165 mm/d 16 mm
- 28040 - Bruska excentrická AKU FESTA SHARE20V 125 mm 8 otv.
- 28055 - Pila ocaska AKU FESTA SHARE20V
- 28080 - Baterie do AKU nářadí FESTA SHARE20V 2,0 Ah
- 28081 - Baterie do AKU nářadí FESTA SHARE20V 4,0 Ah
- 28086 - Nabíječka FESTA SHARE20V 4,0 A



28080  
str. 18



28081  
str. 18



28086  
str. 18



Č.p. specifikace

28101



1

**SHARE**  
**20V** *Li-ion*  
*technology*

**BRUSHLESS**

28002  
str. 5



28030  
str. 12



**BRUSHLESS**

28040  
str. 13



37330



28055  
str. 15



28035  
str. 14



ZVÝHODNĚNÁ  
**CENA**  
+TAŠKA ZDARMA

**FESTA**  
POWER X TOOLS

**AKU SET S TAŠKOU SADA 5+3**

- 28002 - Vrtačka AKU s příklepem FESTA SHARE20V
- 28030 - Bruska úhlová AKU FESTA "BRUSHLESS" SHARE20V 125 mm
- 28035 - Pila kotoučová AKU FESTA SHARE20V 165 mm/d 16 mm
- 28040 - Bruska excentrická AKU FESTA SHARE20V 125 mm 8 otv.
- 28055 - Pila ocaska AKU FESTA SHARE20V
- 28080 - Baterie do AKU nářadí FESTA SHARE20V 2,0 Ah
- 28081 - Baterie do AKU nářadí FESTA SHARE20V 4,0 Ah
- 28086 - Nabíječka FESTA SHARE20V 4,0 A

28080  
str. 18



28081  
str. 18



28086  
str. 18



Č.p. specifikace

28104



1

**BRUSHLESS**

nářadí je poháněno  
bezkartáčovým  
stejnoseměrným motorem

kroučící moment	
otáčky	
volitelný směr otáčení	
sklíčidlo	
vrtání, vrtání s příklepem, šroubování	
počet úderů za minutu	
vrtání, šroubování	
hmotnost s/bez baterie	
způsob uchycení	
způsob uchycení	
způsob uchycení	
excentricita kotouče	
ovládání přístroje pro pravou i levou ruku	
splňuje uvedenou normu	
světelný tok	
směrový úhel světla	
maximální frekvence nastřelování	

**SHARE  
20V**

nářadí je kompatibilní  
s oběma bateriemi

	vhodné typy hřebíků
	vhodné typy spon
	brusný kotouč s otvory
	maximální průměr kotouče
	průměr kotouče
	maximální řezná tloušťka materiál: dřevo
	maximální řezná tloušťka materiál: ocel
	rychloupínání pilky
	uchycení pilky
	počet zdvihů pilky
	nastavení předkmitu
	rychloupínání pilové pilky
	počet kmitů pily
	LED osvětlení
	kapacita baterie
	baterie
	doba nabíjení baterie

**NEW**

otáčky  
520 min<sup>-1</sup>

BPM / přiklep  
0 - 4100 / 12 J

výkon  
1500 W

upínání  
SDS MAX



MAX ø beton - ø 40 mm



hloubkový doraz

system pro omezení vibrací



prachová manžeta

SDS MAX upínací  
hlava nástroje

ergonomická  
pogumovaná  
rukojeť pro  
pohodlný a  
bezpečný úchop



přídavná rukojeť



3.0m

**FESTA**  
POWER X TOOLS

## KLADIVO VRTACÍ A SEKACÍ SDS MAX

Sada obsahuje:

- sekací kladivo
- přídavnou rukojeť
- hloubkový doraz
- montážní klíč
- kufr
- náhradní uhlíky
- prachová manžeta
- nástroje SDS MAX:

ø 16 x 280 mm  
| 18 x 320 mm

náhradní  
uhlíky 2 ks - 28229



230V ~ 50Hz	1500W	4100 bpm	520min <sup>-1</sup>	12J	SDS MAX	3m RUBBER	6.8 kg	MAX ø 40mm Concrete
----------------	-------	-------------	----------------------	-----	------------	--------------	-----------	------------------------

**FESTA**  
POWER X TOOLS

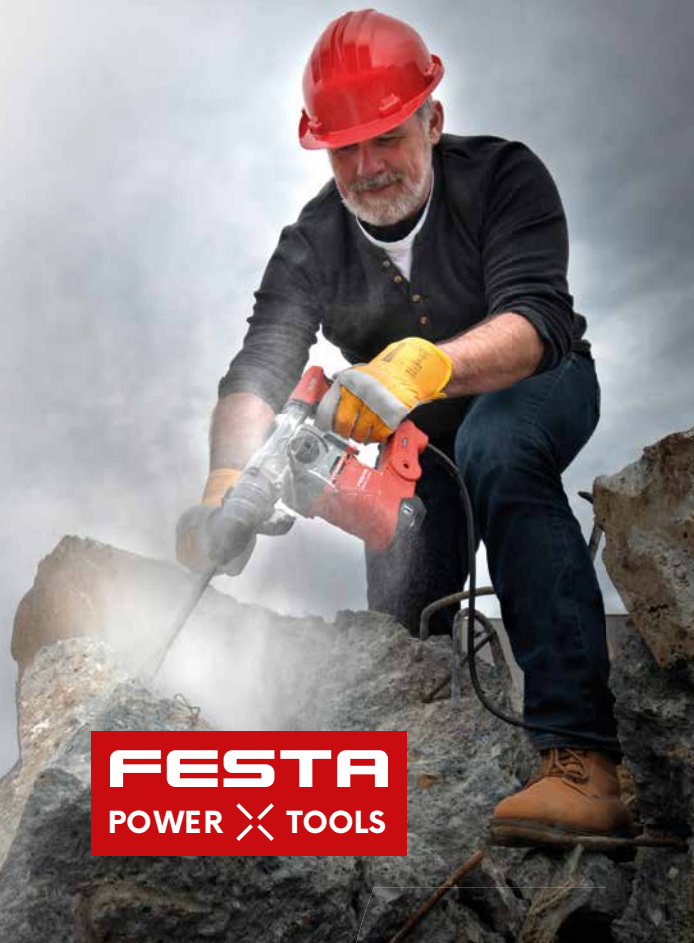

otáčky  
0 - 850 min<sup>-1</sup>

BPM / přiklep  
0 - 4500 / 6 J

výkon  
1500 W

upínání  
SDS+



MAX Ø

beton - ø 32 mm  
kov - ø 13 mm  
dřevo - ø 40 mm



2.0m

**FESTA**  
POWER X TOOLS

## SEKACÍ A VRTACÍ KLADIVO

Sada obsahuje:

- sekací kladivo
- přídavnou rukojeť
- hloubkový doraz
- montážní klíč
- kufr
- náhradní uhlíky
- nástroje SDS+:

⚡ ø 8, 10, 12 x 160 mm

🔧 20 x 250 mm

| 14 x 250 mm



náhradní uhlíky 2 ks - 28228



otáčky  
0 - 1350 min<sup>-1</sup>

BPM / příklep  
0 - 5500 / 2,8 J

výkon  
800 W

upínání  
SDS+  
ø 2 - 13 mm



MAX ø  
beton - ø 26 mm  
kov - ø 13 mm  
dřevo - ø 30 mm



**FESTA**  
POWER X TOOLS

## VRTACÍ A SEKACÍ KLADIVO

Sada obsahuje:

- vrtací kladivo
- přídavnou rukojeť
- hloubkový doraz
- sklíčidlo ø 2 - 13 mm
- kufr
- vazelína
- náhradní uhlíky
- nástroje SDS+:

ø 6, 8, 10 x 160 mm

20 x 250 mm

14 x 250 mm



náhradní uhlíky 2 ks - 28223



Č.p.  
28220

Specifikace



otáčky  
0 - 4500 min<sup>-1</sup>

hmotnost  
4,3 kg

výkon  
1400 W

kotouč / upínání  
max ø 185 mm / ø 20 mm



max. 63 mm



ergonomická  
pogumovaná  
rukojeť pro  
pohodlný a  
bezpečný úchop



max. 45°



boční vedení  
- doraz 6 - 120 mm

odsávání prachu  
ø 35 mm

2.0m



**FESTA**  
POWER X TOOLS

**KOTOUČOVÁ PILA**

- Sada obsahuje:
- kotoučovou pilu
  - doraz bočního vedení
  - montážní inbus
  - náhradní uhlíky
  - kotouč ø 185 x 2,3/1,3 x 20 mm 24T (22316)



22316

1400W	230V ~ 50Hz	4500 min <sup>-1</sup>	ø 20 1 mm MAX 185mm	90° 63mm	45° 42mm	KG 4.3
-------	----------------	------------------------	---------------------------	-------------	-------------	-----------

náhradní  
uhlíky 2 ks - 28233



Č. p. Specifikace  
28230

otáčky  
6600 min<sup>-1</sup>

hmotnost  
5,8 kg

výkon  
2400 W

upínání  
M14  
max ø 230 mm



ergonomická  
pogumovaná  
rukojeť pro  
pohodlný a  
bezpečný úchop

## SOFT START

plynulý rozběh motoru



kryt kotouče



**FESTA**  
POWER X TOOLS

## ÚHLOVÁ BRUSKA

Sada obsahuje:

- úhlovou brusku
- kryt kotouče
- přídavnou rukojeť
- montážní klíč
- náhradní uhlíky



náhradní  
uhlíky 2 ks - 28218



Č.p. Specifikace

28215

2

otáčky  
11000 min<sup>-1</sup>

hmotnost  
2 kg

výkon  
900 W

upínání  
M14  
max ø 125 mm

přídavná rukojeť



spínač s pojistkou

**SOFT START**  
plynulý rozběh motoru



kryt kotouče

3,0m

**FESTA**  
POWER X TOOLS

## ÚHLOVÁ BRUSKA

Sada obsahuje:

- úhlovou brusku
- kryt kotouče
- přídavnou rukojeť
- montážní klíč
- náhradní uhlíky



náhradní uhlíky 2 ks - 28213



Č.p. Specifikace

28210

8

**FESTA**  
POWER X TOOLS

## NÁHRADNÍ UHLÍKY

2x



Č.p.	specifikace	
28229	pro 28221 - sekačí a vrtací kladivo	1
28228	pro 28225 - sekačí a vrtací kladivo	1
28223	pro 28220 - vrtací a sekačí kladivo	1
28233	pro 28230 - kotoučová pila	1
28213	pro 28210 - úhlová bruska	1
28218	pro 28215 - úhlová bruska	1



**ADAPTÉR SDS MAX NA SDS +**

	→		
Č.p.	specifikace		
20744		1	



**ADAPTÉR SDS +**

Č.p.	specifikace		
20745		1	



**FESTA**

**ADAPTÉR SDS + NA BIT 1/4"**

	→			
Č.p.	specifikace			
20743	75 mm		20	



**FESTA**

**SKLÍČIDLO**

Č.p.	specifikace		
20960	1-13 mm + 2 klíče, 1/2 - 20 UNF	3	
20966	náhradní klíček	25	



**FESTA**

**SKLÍČIDLO RYCHLOUPÍNACÍ**

Č.p.	specifikace		
20965	1,5 - 13 mm 1/2' - 20 UNF	1	



**SKLÍČIDLO RYCHLOUPÍNACÍ**

Č.p.	specifikace		
20961	1,5 - 13 mm 1/2' - 20 UNF	1	



**NÁSTAVEC NA VRTÁNÍ 90°**

Č.p.	specifikace		
20365	Ø 1 - 10 mm	10	



**SKLÍČIDLO RYCHLOUPÍNACÍ DO AKU**

Č.p.	specifikace		
20963	Ø 1 - 6 mm	10	



**FESTA**

**NÁSTAVEC NA ODSÁVÁNÍ PRACHU**

Č.p.	specifikace		
28267	max. 70 mm	1	

**VODIČ NA VRTÁKY A VRTACÍ KORUNKY**

Č.p.	specifikace		
20379	Ø 4, 5, 6, 7, 8, 10, 12 mm	10	

TECHNICKÁ  
SPECIFIKACE

KATALOGOVÉ ČÍSLO PRODUKTU	28000	28001	28002	28003	28004
Název	Vrtačka AKU s příklepem	Vrtačka AKU s příklepem	Vrtačka AKU s příklepem	Vrtačka AKU s příklepem	Vrtačka AKU s příklepem
Otáčky bez zatížení	I.0-550 min <sup>-1</sup> II.0-2000 min <sup>-1</sup>	I.0-550 min <sup>-1</sup> II.0-2000 min <sup>-1</sup>	I.0-550 min <sup>-1</sup> II.0-2000 min <sup>-1</sup>	I.0-500 min <sup>-1</sup> II.0-1800 min <sup>-1</sup>	I.0-500 min <sup>-1</sup> II.0-1800 min <sup>-1</sup>
Počet příklepů	I.0-8800min <sup>-1</sup> II.0-32000min <sup>-1</sup>	I.0-8800min <sup>-1</sup> II.0-32000min <sup>-1</sup>	I.0-8800min <sup>-1</sup> II.0-32000min <sup>-1</sup>	0-19200 min <sup>-1</sup>	0-19200 min <sup>-1</sup>
Počet rázů					
Kroutící moment	80 Nm	80 Nm	80 Nm	45 Nm	45 Nm
Max. napětí akumulátoru	20V	20V	20V	20V	20V
Počet stupňů kroutícího momentu	20+1+1	20+1+1	20+1+1	19+1+1	19+1+1
Upínací hlava	2-13 mm	2-13 mm	2-13 mm	2-13 mm	2-13 mm
Hmotnost bez baterie	1,4kg	1,4kg	1,4kg	1,3kg	1,3kg
Krytí	IPX0	IPX0	IPX0	IPX0	IPX0
Hladina akustického tlaku nejistota K	LpA=97,04dB(A) K=5dB(A)	LpA=97,04dB(A) K=5dB(A)	LpA=97,04dB(A) K=5dB(A)	LpA=79dB(A) K=5dB(A)	LpA=79dB(A) K=5dB(A)
Hladina akustického výkonu nejistota K	LwA=86,04dB(A) K=5dB(A)	LwA=86,04dB(A) K=5dB(A)	LwA=86,04dB(A) K=5dB(A)	LwA=90dB(A) K=5dB(A)	LwA=90dB(A) K=5dB(A)
Vibrace bez příklepu do kovu	$a_{h,D}=3,9m/s^2$ K=1,5m/s <sup>2</sup>	$a_{h,D}=3,9m/s^2$ K=1,5m/s <sup>2</sup>	$a_{h,D}=3,9m/s^2$ K=1,5m/s <sup>2</sup>	$a_{h,D}=2,4m/s^2$ K=1,5m/s <sup>2</sup>	$a_{h,D}=2,4m/s^2$ K=1,5m/s <sup>2</sup>
Vibrace bez příklepu do betonu	$a_{h,D}=11,4m/s^2$ K=1,5m/s <sup>2</sup>	$a_{h,D}=11,4m/s^2$ K=1,5m/s <sup>2</sup>	$a_{h,D}=11,4m/s^2$ K=1,5m/s <sup>2</sup>	$a_{h,D}=7,5m/s^2$ K=1,5m/s <sup>2</sup>	$a_{h,D}=7,5m/s^2$ K=1,5m/s <sup>2</sup>
Maximální vibrace, nejistota K					
Síla úderu					
Průměr vrtání					
Vibrace do betonu-hlavní rukojeť					
Vibrace do betonu-přídavná rukojeť					
Obsah balení	vrtačka, nabíječka 2,4 A, baterie 2,0 Ah, baterie 4,0 Ah, přídavná rukojeť, kufr	vrtačka, nabíječka 2,4 A, baterie 2,0 Ah, přídavná rukojeť, kufr	vrtačka	vrtačka, nabíječka 2,4 A, 2x baterie 2,0 Ah, 6x bit, unášec, 6x vrták, kufr	vrtačka



28005	28006	28007	28008	28021	28025
Vrtačka AKU	Vrtačka AKU	Vrtačka AKU	Šroubovák AKU	Utahovák AKU rázový	Kladivo vrtací AKU
I.0-350 min <sup>-1</sup> II.0-1300 min <sup>-1</sup>	I.0-350 min <sup>-1</sup> II.0-1300 min <sup>-1</sup>	I.0-350 min <sup>-1</sup> II.0-1300 min <sup>-1</sup>	200 min <sup>-1</sup>	0-2000 min <sup>-1</sup>	I.0-300 min <sup>-1</sup> II.0-1000 min <sup>-1</sup>
					0-5000bpm
					0-3000bpm
28 Nm	28 Nm	20 Nm	3 Nm	150 Nm	
20V	20V	12V	3,6V	20V	20V
19+1	19+1	19+1	6+1		
1-10mm	1-10mm	1-10mm	1/4" šestihran	1/4" šestihran	SDS+
0,9kg	0,9kg	*1kg	*0,4kg	1,2kg	1,7kg
IPX0	IPX0	IPX0	IPX0	IPX0	IPX0
LpA=69dB(A) K=5dB(A)	LpA=69dB(A) K=5dB(A)	LpA=78dB(A) K=5dB(A)	LpA=58dB(A) K=3dB(A)	LpA=92dB(A) K=3dB(A)	LpA=82,98dB(A) K=3dB(A)
LwA=80dB(A) K=5dB(A)	LwA=80dB(A) K=5dB(A)	LwA=67dB(A) K=5dB(A)	LwA=69dB(A) K=3dB(A)	LwA=103dB(A) K=3dB(A)	LwA=93,98dB(A) K=3dB(A)
$\alpha_{h,D} < 1,9m/s^2$ K=1,5m/s <sup>2</sup>	$\alpha_{h,D} < 1,9m/s^2$ K=1,5m/s <sup>2</sup>	$\alpha_{h,D} = 2,1m/s^2$ K=1,5m/s <sup>2</sup>			
$\alpha_{h,D} = 10,1m/s^2$ K=1,5m/s <sup>2</sup>	$\alpha_{h,D} = 10,1m/s^2$ K=1,5m/s <sup>2</sup>	$\alpha_{h,D} = 7,5m/s^2$ K=1,5m/s <sup>2</sup>			
			$\alpha_h < 2,5m/s^2$ K=1,5m/s <sup>2</sup>	$\alpha_{h,D} = 15,9m/s^2$ K=1,5m/s <sup>2</sup>	
					1,2J
					ocel:10mm beton: 20mm dřevo: 20mm
					$\alpha_{h,(HD)} = 5,582m/s^2$ K=1,5m/s <sup>2</sup>
					$\alpha_{h,(HD)} = 5,523m/s^2$ K=1,5m/s <sup>2</sup>
vrtačka, nabíječka 2,4 A, 2x baterie 2,0 Ah, 6x bit, unašeč, 6x vrták, kufr	vrtačka	vrtačka, nabíječka 2,4 A, 2x baterie 1,5 Ah, 6x bity, unašeč, 6x vrták, kufr	šroubovák, nabíječka 0,5 A, baterie 1,5 Ah, 5x bit	utahovák	vrtací kladivo, přídavná rukojeť, hlubkový doraz

\*hmotnost je uvedena včetně baterie

TECHNICKÁ  
SPECIFIKACE

KATALOGOVÉ ČÍSLO PRODUKTU	28030	28032	28035	28040
Název	Bruska AKU	Bruska AKU	Pila AKU kotoučová	Bruska AKU excentrická
Otáčky bez zatížení	8500 min <sup>-1</sup>	8000 min <sup>-1</sup>	3650 min <sup>-1</sup>	10000 min <sup>-1</sup>
Počet kmitů bez zatížení				
Předkmit				
Počet stupňů předkmitu				
Počet zdvihů pilového plátku				
Maximální řezaný profil				
Maximální průměr kotouče	125 mm	115 mm		
Nosný kotouč				125 mm
8 odsávacích otvorů na kružnici				65 mm
Excentricita kotouče				5 mm
Velikost závitů vřetena	M14	M14		
Maximální tloušťka řezaného materiálu	15 mm	15 mm		
Max. napětí akumulátoru	20V	20V	20V	20V
Nastavitelný úhel sklonu řezu			0-45°	
Prořez při úhlu 45°			35 mm	
Prořez při úhlu 90°			50 mm	
Úhel oscilace				
Rozměr delta brusné základny				
Regulace rychlosti kmitání				
Uchycení pilového plátku				
Zdvih pilového plátku				
Rozměr základové desky			28 cm x 13,3 cm	
Hmotnost bez baterie	1,6kg	1,6kg	2,7kg	1kg
Průměr kotouče			165 mm	
Tloušťka těla kotouče			1,4 mm ± 5% mm	
Tloušťka SK plátku kotouče			2,0 ± 5% mm	
Šířka řezu			2,3 ± 5% mm	
Průměr otvoru kotouče po upnutí			16 mm	
Počet zubů kotouče			24	
Krytí	IPX0	IPX0	IPX0	IPX0
Hřebíky-typ, výška x šířka x tloušťka				
Spony-rozpětí x výška x šířka x tloušťka				
Max. délka hřebíků/spon do měkkých mat.				
Max. délka hřebíků/spon do tvrdých mat.				
Průměrná/max. frekvence nastřelování				
Doba provozu (baterie 4 AH, plně nabitá)				
Kapacita zásobníku hřebíků/spon				
Hladina akustického tlaku nejistota K	LpA=87,1dB(A) K=3dB(A)	LpA=76,67dB(A) K=3dB(A)	LpA=84dB(A) K=3dB(A)	LpA=76dB(A) K=3dB(A)
Hladina akustického výkonu nejistota K	LwA=98,1dB(A) K=3dB(A)	LwA=87,67dB(A) K=3dB(A)	LwA=95dB(A) K=3dB(A)	LwA=87dB(A) K=3dB(A)
Vibrace při broušení povrchu	$a_{h,AG}=8,363m/s^2$ K=1,5m/s <sup>2</sup>	$a_{h,AG}=5,324m/s^2$ K=1,5m/s <sup>2</sup>		
Vibrace pro řezání desky				
Vibrace pro řezání plechu				
Vibrace pro řezání dřevěných ráků				
Maximální vibrace, nejistota K			$a_h < 2,5m/s^2$ K=1,5m/s <sup>2</sup>	$a_h = 9,5m/s^2$ K=1,5m/s <sup>2</sup>
Obsah balení	bruska, kryt kotouče, přídatná rukojeť, klíč	bruska, kryt kotouče, přídatná rukojeť, klíč	pila, hloubkový doraz, pilový kotouč	bruska, sběrný vak na prach



28045	28050	28055	28070
Bruska AKU multifunkční	Pila AKU přímočará	Pila AKU ocaska	Hřebíkovačka/sponkovačka AKU
5000-15000 min <sup>-1</sup>		0-3000 min <sup>-1</sup>	
		1°	
	3+0		
	0-2400 min <sup>-1</sup>		
	ocel: 6mm, dřevo: 80mm	dřevo: 100 mm, ocel: 5 mm, hliník/měď: 20 mm	
20V		20V	20V
	zkosení řezu max. 45°		
3°			
90 mm			
ANO			
univerzální		univerzální	
		20 mm	
1kg	1,8kg	1,7kg	2,7kg
IPX0	IPX0	IPX0	IPX0
			F, 20-50mm x 1,2mm x 1,0 mm
			6,0mm x 19-40mm x 1,2mm x 1,0mm
			50 mm
			30 mm
			60/100 min <sup>-1</sup>
			1 hodina
			100 kusů
LpA=78dB(A) K=3dB(A)	LpA=88,1dB(A) K=5dB(A)	LpA=87,33dB(A) K=5dB(A)	LpA=79,9dB(A) K=3dB(A)
LwA=89dB(A) K=3dB(A)	LwA=99,1dB(A) K=5dB(A)	LwA=98,33dB(A) K=5dB(A)	LwA=90,9dB(A) K=3dB(A)
	$\alpha_{h,B}=3,3m/s^2$ $K=1,5m/s^2$ $\alpha_{h,M}=4m/s^2$ $K=1,5m/s^2$	$\alpha_{h,B}=21,10m/s^2$ $K=1,5m/s^2$	
		$\alpha_{h,WB}=21,98m/s^2$ $K=1,5m/s^2$	
$\alpha_h=2,8m/s^2$ $K=1,5m/s^2$			$\alpha_h=1,39m/s^2$ $K=1,5m/s^2$
bruska, nástavce (pilka, škrabka, unašeč), 3x brusný papír P80	pilka, vodící lišta, nástavec pro odsávání, 2x pilový list	pila, 2x pilový plátek	hřebíkovačka/ sponkovačka, 200x hřebíky, 200x spony

TECHNICKÁ  
SPECIFIKACE

KATALOGOVÉ ČÍSLO PRODUKTU	28075	36328	36329	28060	28076
Název	Kompresor AKU	Vybrátor s přísavkou na dlažbu AKU	Vybrátor s přísavkou na dlažbu AKU	Pistole vytlačovací AKU	Rádio AKU DAB+ / FM / BT
Jednotky manometru	psi; bar; kgf/cm <sup>2</sup> ; kPa				
Max. tlak	120 psi / 8,2 bar				
Hadice	Ø 10,5 x 600 mm				
Průměr přísavky		Ø 123 mm	Ø 123 mm		
Max. nosnost		60 kg	60 kg		
Vibrace		12 stupňů 3500 - 8500 r/min	12 stupňů 3500 - 8500 r/min		
Vytlačovací síla				6500 N	
Rychlost vytlačování				0 - 8,7 mm/s	
Max. velikost kartuše				310 ml	
Příjem					DAB+ / FM
Externí vstupy					Bluetooth 5.0, aux IN jack 3,5 mm
Výkon					2 x 15 W
Display					color 2,4"
Napájení					adaptér 230 V, baterie Li-ion FESTA share 20 V
Počet paměťových míst					30 (DAB+), 30 (FM)
Voděodolnost					IPX54
Hmotnost bez baterie		3 kg	3 kg	1,7 kg	1,3kg
Max. napětí akumulátoru	20 V	20 V	20 V	20 V	20 V
Obsah balení	kompresor, adaptér do autozásuvky, 3x adaptéry pro nafukování	vibrační přísavka, baterie 2,0 Ah, nabíječka, kufr	vibrační přísavka, kufr	vytlačovací pistole	rádio, adaptér 230 V



KATALOGOVÉ ČÍSLO PRODUKTU	28221	28225	28220	28230	28210	28215
Název	Sekací kladivo SDS MAX	Sekací kladivo SDS +	Vrtací kladivo	Kotoučová pila	Úhlová bruska	Úhlová bruska
Výkon	1 500 W	1 500 W	800 W	1 400 W	900 W	2 400 W
Otáčky bez zatížení	0 - 520 min-1	0 - 850 min-1	0 - 1 350 min-1	0 - 4 500 min-1	0 - 11 000 min-1	0 - 6 600 min-1
Počet přiklepů	0 - 4 100	0 - 4 500	0 - 5 500			
Síla úderu	12 J	6 J	2,8 J			
Upínací hlava / hřídel	SDS MAX	SDS+	SDS+ sklíčidlo 2 - 13 mm	20 mm	M14 / 22,2 mm	M14 / 22,2 mm
Nastavitelný úhel sklonu řezu				0 - 45°		
Prořez při úhlu 45°				42 mm		
Prořez při úhlu 90°				63 mm		
Max. průměr kotouče				185 mm	125 mm	230 mm
Hmotnost	6,8 kg	5 kg	3,2 kg	4,3 kg	2 kg	5,8 kg
Délka napájecího kabelu l materiál	3 m l guma	2 m l guma	2 m l guma	2 m l plast	2 m l guma	2 m l guma
Obsah balení	sekací kladivo, přídavná rukojeť, hloubkový doraz, montážní klíč, kufr, náhradní uhlíky, nástroje SDS MAX: ∅ 16 x 280 mm   18 x 320 mm	sekací kladivo, přídavná rukojeť, hloubkový doraz, montážní klíč, kufr, náhradní uhlíky, nástroje SDS+: ∅ 8, 10, 12 x 160 mm ∅ 20 x 250 mm   14 x 250 mm	vrtací kladivo, přídavná rukojeť, hloubkový doraz, kufr, sklíčidlo ∅ 2 - 13 mm, náhradní uhlíky, nástroje SDS+: ∅ 6, 8, 10 x 160 mm ∅ 20 x 250 mm   14 x 250 mm	kotoučová pila, doraz bočního vedení, montážní inbus, náhradní uhlíky, kotouč ∅ 185 x 2,3/1,3 x 20 mm 24T	úhlová bruska, kryt kotouče, přídavná rukojeť, montážní klíč, náhradní uhlíky	úhlová bruska, kryt kotouče, přídavná rukojeť, montážní klíč, náhradní uhlíky

NEW

otáčky  
1000 - 1850 min<sup>-1</sup>

délka  
110 - 180 cm

výkon  
750 W

brusný kotouč  
Ø 225 mm



ergonomická  
pogumovaná  
rukojeť pro  
pohodlný a  
bezpečný úchop



**FESTA**  
POWER X TOOLS

BRUSKA NA SÁDROKARTON

230V ~ 50Hz	750W	1000-1850min <sup>-1</sup>	Ø 225mm	110-180 cm
LED	4m	DRYWALL		



Č.p. 28240 Specifikace

1

**NEW**



**FESTA**  
POWER X TOOLS

VYSAVAČ 30L

230 V ~50 Hz 1600 W MAX 2000W 82dB IPX4 3m 5m

30L WET DRY AUTO ON-OFF AUTOMATIC FILTER CLEANING HEPA

Č.p.	Specifikace	
28345		1
28346	HEPA filtr	1

**NEW**



**WEST BERG**

VYSAVAČ 30L

230 V ~50 Hz 1200 W 3m 5m

30L WET DRY AUTO ON-OFF SEMI-AUTOMATIC FILTER CLEANING HEPA

Č.p.	Specifikace	
28340		1
28342	HEPA filtr	1

**FESTA**  
 POWER X TOOLS

**ELEKTRICKÉ MÍCHADLO STAVEBNÍCH SMĚSÍ DVOUMETLOVÉ**

příkon	1800 W
napětí/frekvence	230 V / 50 Hz
rychlostní stupně	2
1. stupeň (volnoběžné otáčky)	0 - 450 ot./min.
2. stupeň (volnoběžné otáčky)	0 - 790 ot./min.
ochrana proti přetížení	Ano
průměr míchacího koše	100 mm
délka míchací metly	570 mm
hmotnost	5,6 kg

**Zn** **CE**

Č.p.	specifikace	
35311	míchadlo	1
35318	náhradní uhlíky	1
35319	míchadla náhradní - pár (L+P)	1

**FESTA**  
 POWER X TOOLS

**ELEKTRICKÉ MÍCHADLO STAVEBNÍCH SMĚSÍ 1600 W**

příkon	1600 W
napětí/frekvence	230 V / 50 Hz
rychlostní stupně	2
1. stupeň (volnoběžné otáčky)	0 - 480 ot./min.
2. stupeň (volnoběžné otáčky)	0 - 800 ot./min.
ochrana proti přetížení	Ano
závit míchací metly	M 14
průměr míchacího koše	140 mm
délka míchací metly	600 mm
hmotnost	4,7 kg

**M14** **Zn** **CE**

Č.p.	specifikace	
35310		1
35317	náhradní uhlíky	1

**FESTA**  
 POWER X TOOLS

**ELEKTRICKÉ MÍCHADLO STAVEBNÍCH SMĚSÍ 850 W**

příkon	850 W
napětí/frekvence	230 V / 50 Hz
rychlostní stupně	1
1. stupeň (volnoběžné otáčky)	0 - 500 ot./min.
2. stupeň (volnoběžné otáčky)	-
ochrana proti přetížení	Ano
závit míchací metly	M 14
průměr míchacího koše	120 mm
délka míchací metly	600 mm
hmotnost	3,7 kg

**M14** **Zn** **CE**

Č.p.	specifikace	
35300		1
35316	náhradní uhlíky	1



NEW

**WEST  
BERG****ELEKTRICKÉ MÍCHADLO STAVEBNÍCH SMĚSÍ 1600 W**

příkon	1600 W
napětí/frekvence	230 V / 50 Hz
rychlostní stupně	2
1. stupeň (volnoběžné otáčky)	180 - 400 ot./min.
2. stupeň (volnoběžné otáčky)	300 - 700 ot./min.
ochrana proti přetížení	Ano
závit míchací metly	M 14
průměr míchacího koše	140 mm
délka míchací metly	600 mm
hmotnost	5,4 kg

M14 Zn CE



Č.p. specifikace

35305



1

35315 náhradní uhlíky

1



NEW

**FESTA**  
POWER X TOOLS**ČISTIČ  
VYSOKOTLAKÝ**

230 V ~50 Hz	1800 W	IPX5	MAX 7 l/min	MAX 140 bar	MAX 50°C	5m	AUTO STOP	7,8 kg
-----------------	-----------	------	-------------------	-------------------	-------------	----	--------------	-----------

Č.p. specifikace

45271



1

**FESTA****ČISTIČ  
VYSOKOTLAKÝ**

230 V ~50 Hz	1500 W	MAX 120 bar	MAX 6 l/min	IPX5	5m	AUTO STOP
-----------------	-----------	-------------------	-------------------	------	----	--------------

Č.p. specifikace

45270 čistič vysokotlaký



1

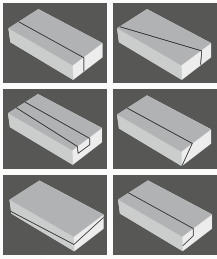

**FESTA**  
POWER X TOOLS

## ŘEZAČKA POLYSTYRENU STRUNOVÁ

- napětí/frekvence: 230 V/50 Hz
  - příkon: 200 W
  - délka řezu: 137 cm
  - výška řezu: 35 cm
  - krytí: IP44
  - úhel řezu: 0° - 90°
- vybavení: stojan, nožní spínač, držák na lešení, 2x Ni-Cr řezací drát, čistící mosazný kartáč, nářadí a spojovací materiál, plastový box s kolečky



Č.p. Specifikace

35348



1

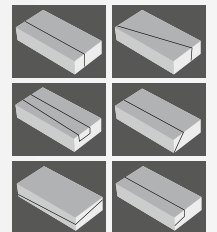
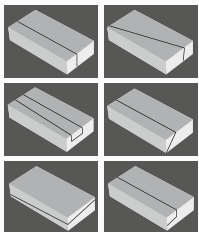

137 cm

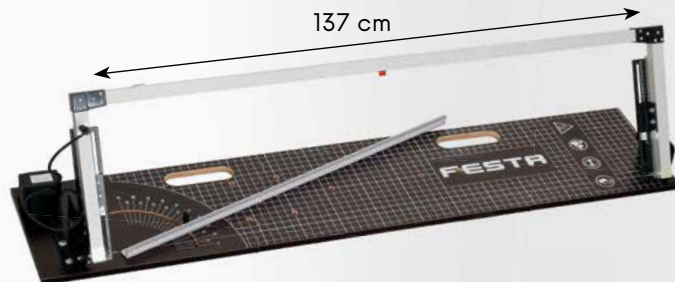

117 cm



**FESTA**  
POWER X TOOLS

## ŘEZAČKA POLYSTYRENU STRUNOVÁ

- napětí/frekvence: 230 V / 50 Hz
- příkon: 200 W
- délka řezu: 137 cm
- výška řezu: 35 cm
- krytí: IP44
- úhel řezu: 0° - 90°



· vybavení: Ni-Cr řezací drát, čistící mosazný kartáč, inbus

Č.p. specifikace

35345



1

**FESTA**  
POWER X TOOLS

## ŘEZAČKA POLYSTYRENU STRUNOVÁ

- napětí/frekvence: 230 V / 50 Hz
- příkon: 160 W
- délka řezu: 117 cm
- výška řezu: 35 cm
- krytí: IP44
- úhel řezu: 0° - 90°



· vybavení: Ni-Cr řezací drát, čistící mosazný kartáč, inbus

Č.p. specifikace

35330



1



**FESTA**

**ŘEZAČKA POLYSTYRENU STRUNOVÁ**

- napětí/frekvence: 230 V / 50 Hz
- příkon: 160 W
- délka řezu: 117 cm
- výška řezu: 52 cm
- krytí: IP44
- úhel řezu: 0° - 90°



· vybavení: Ni-Cr řezací drát, čistící mosazný kartáč, inbus

Č.p.	specifikace	
35344		1



**FESTA**

**NOŽNÍ SPÍNAČ PRO ŘEZAČKU POLYSTYRENU**

· pro 35330, 35345, 35348



Č.p.	Specifikace	
35334		1

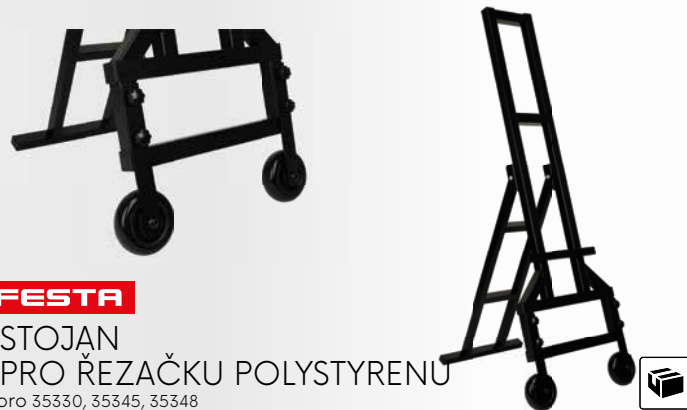

**FESTA**

**STOJAN PRO ŘEZAČKU POLYSTYRENU**

· pro 35330, 35345, 35348



Č.p.	Specifikace	
35336		1



**FESTA**

**NÁHRADNÍ PRUŽINA PRO ŘEZAČKU POLYSTYRENU**

· pro 35330, 35345, 35348



Č.p.	Specifikace	
35332		1



**FESTA**

**DRŽÁK NA LEŠENÍ PRO ŘEZAČKU POLYSTYRENU**

· pro 35330, 35345, 35348



Č.p.	Specifikace	
35333		1



**FESTA**

**ZDROJ NÁHRADNÍ K ŘEZAČCE POLYSTYRENU**

· pro 35330, 35345, 35348



napětí/frekvence:	230 V / 50Hz
output:	36 V / 5 A
výkon:	200 W



Č.p.	specifikace	
35331	pro řezačku 117 cm	1
35346	pro řezačku 137 cm	1

**NÁHRADNÍ STRUNA Cr-Ni PRO ŘEZAČKY POLYSTYRENU**





Li-ion  
technology

**FESTA**  
POWER X TOOLS

### ŘEZAČKA POLYSTYRENU AKUMULÁTOROVÁ

- baterie 36 V, 1,5Ah Li-ion
- výkon 180 W
- teplota max 350 C°
- délka čepel 20 cm
- vybavení: 2 ks baterie, nabíječka, čepel, čistící mosazný kartáč, inbus



Č.p.	specifikace	
35323	elektrická řezačka polystyrenu	1
35328	náhr. nůž do řezačky polystyrenu 14 cm	1
35329	náhr. nůž do řezačky polystyrenu 25 cm	1



**FESTA**  
POWER X TOOLS

### ŘEZAČKA POLYSTYRENU ELEKTRICKÁ

- napětí / frekvence 230 V/50 Hz
- příkon 250 W
- teplota 50-600 C°
- délka čepel 25 cm
- délka přívodního kabelu 3 m



- vybavení: čistící mosazný kartáč, inbus, nůž 25 cm, kufr

Č.p.	specifikace	
35326	elektrická řezačka polystyrenu	1
35328	náhr. nůž do řezačky polystyrenu 14 cm	1
35329	náhr. nůž do řezačky polystyrenu 25 cm	1

### VODÍČÍ LIŠTA PRO ŘEZAČKU POLYSTYRENU

· pro 35323, 35326

Č.p.	specifikace	
35327	vodící lišta	1
35335	náhradní nůž - 30 cm	1

**FESTA**  
POWER X TOOLS

### ŘEZAČKA POLYSTYRENU ELEKTRICKÁ



- regulace teploty

Č.p.	specifikace	
35325	220 W	1



**FESTA**

## SVÁŘECÍ INVERTOR TIG/MMA 160 A



napětí/frekvence:	230 V / 50 Hz
napětí naprázdno:	55 V
regulační rozsah svářecích proudů	10 - 160 A
průměr elektrody:	1,5 - 4,0 mm
pracovní cyklus:	TIG- 160 A / 60%, MMA- 140 A / 60%
třída ochrany:	IP 21
druh svařování:	TIG/MMA
rozměry:	405 x 165 x 270 mm
technologie:	anti-stick, Arc-force, Hot start, Lift TIG
hmotnost:	6 kg



C.p. specifikace

70040 svařovací invertor TIG/MMA 160A



1

**FESTA****FESTA**

## KUKLA SVÁŘEČSKÁ SAMOSTMÍVACÍ

velikost zorného pole:	98 x 80 mm
rychlost zatmavení filtru:	1/25 000 s
zatmavení filtru:	DIN 5-8 / 9-13
UV/IR ochrana:	DIN 16
optická třída:	1   1   1   1   2
počet senzorů:	4
napájení:	solární články + vyměnitelná baterie CR2450
pracovní režim:	sváření, broušení

LCD display

**CE EN  
379**

C.p. specifikace

70064	aktivní	1
70066	náhradní krycí plexisklo	1

**FESTA**

### KUKLA SVÁŘEČSKÁ SAMOSTMÍVACÍ - CARBON



Č.p.	specifikace	
70063	aktivní	4



### KUKLA SVÁŘEČSKÁ SAMOSTMÍVACÍ



Č.p.	specifikace	
70060	aktivní	4



### KUKLA SVÁŘEČSKÁ



Č.p.	specifikace	
70061		4



### SKLÍČKO NÁHRADNÍ KRYCÍ DO SVÁŘEČSKÉ KUKLY

2x

Č.p.	specifikace	
70065	113 x 80 mm	20



### BRÝLE SVÁŘEČSKÉ



Č.p.	specifikace	
70062		1



### ELEKTRODA RUTILOVÁ ER 117

· certifikované

Č.p.	specifikace	množství	
70021	Ø 2,0 x 300 mm	10 ks	1
70020	Ø 2,0 x 300 mm	2,5 kg	8
70026	Ø 2,5 x 300 mm	10 ks	1
70025	Ø 2,5 x 300 mm	2,5 kg	8
70033	Ø 3,2 x 350 mm	10 ks	1
70032	Ø 3,2 x 350 mm	5 kg	4



### ELEKTRODA BAZICKÁ

· certifikované

Č.p.	specifikace	množství	
70030	Ø 2,0 x 300 mm	2,5 kg	1
70031	Ø 2,0 x 300 mm	5 kg	1
70035	Ø 2,5 x 300 mm	2,5 kg	8
70036	Ø 2,5 x 300 mm	10 ks	1
70037	Ø 3,2 x 350 mm	5 kg	5



### KLADIVO SVÁŘEČSKÉ



Č.p.	specifikace	
19115	320 g	1



### DRŽÁK ELEKTRODY



Č.p.	specifikace	
70070	300 A	1



### KLEŠŤ ZEMNÍCÍ



Č.p.	specifikace	
70075	300 A	1

**FESTA****MAGNET ÚHLOVÝ**

Č.p.	specifikace	nosnost	
70096	150 x 130 x 30 mm · 45°, 90°, 135°	25 kg	10

**MAGNET ÚHLOVÝ**

Č.p.	specifikace	nosnost	
70090	85 x 85 mm · 45°, 90°	9 kg	10

**MAGNET ÚHLOVÝ**

Č.p.	specifikace	nosnost	
70093	95 x 64 mm · 30°, 45°, 60°, 75°, 90°	9 kg	10
70094	120 x 90 mm · 30°, 45°, 60°, 75°, 90°	18 kg	10
70095	137 x 110 mm · 30°, 45°, 60°, 75°, 90°	27 kg	10

**MAGNET ÚHLOVÝ**

Č.p.	specifikace	nosnost	
70091	95 x 109 x 25 mm · 45°, 90°, 135°	13 kg	10
70092	130 x 150 x 32 mm · 45°, 90°, 135°	22 kg	5

**FESTA**  
POWER X TOOLS**POLYFÚZNÍ SVÁŘEČKA  
PLASTOVÝCH TRUBEK**

- napětí / frekvence 230 V / 50 Hz
- příkon 750 / 1500 W
- teplota 0-300 °C
- nástavce Ø 20,25,32,40,50,63 mm
- váha 1,6 kg



· součást balení: metr, vodováha, šroubovák, inbus klíč, nůžky na trubky, 6x svařovací nástavec, stojánek, plechový kufr

Č.p.	
17182	1

**FESTA**  
POWER X TOOLS**HROTOVÁ POLYFÚZNÍ SVÁŘEČKA  
PLASTOVÝCH TRUBEK**

- napětí / frekvence 230 V / 50 Hz
- příkon 800 / 1000 W
- teplota 0-300 °C
- nástavce Ø 16, 20, 25, 32 mm
- váha 1 kg



· součást balení: inbus, 4x svařovací nástavec, stojánek, plechový kufr

Č.p.	
17183	1

**FESTA****KOMPRESOR 6 L - BEZOLEJOVÝ**

napětí/frekvence:	230 V / 50Hz
příkon:	1,2 kW (1,5HP)
objem nádrže:	6 l
max. tlak:	8 Bar
otáčky:	3900 min.
sací výkon:	180 l/min.
plnicí výkon:	116 l/min.
hmotnost:	10 kg



Č.p.

35360



1

**KOMPRESOR 24 L  
BEZOLEJOVÝ**

výkon:	1100 W
napájení:	230 V / 50Hz
běh bez zátěže:	2850 min-1
pracovní tlak:	8 bar
volný přívod vzduchu:	160 l / min
typ:	bezolejový / without oil
kapacita zásobníka:	24 L
hmotnost:	23 kg



Č.p.

specifikace

35361 1,1 kW, 24 l



1

**KOMPRESOR 24 L**

výkon:	1500 W
napájení:	230 V / 50Hz
běh bez zátěže:	2850 min-1
pracovní tlak:	8 bar
volný přívod vzduchu:	200 l / min
typ:	olejový / oleic
kapacita zásobníka:	24 L
hmotnost:	24 kg



Č.p.

specifikace

35362 1,5 kW, 24 l



1

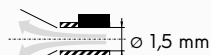

500 ml

**FESTA****PIŠTOLE  
STRÍKACÍ**

Ø 1,5 mm



Č.p.

specifikace

48020 horní



1



600 ml

**FESTA****PIŠTOLE  
STRÍKACÍ**

Ø 1,4 mm



Č.p.

specifikace

48021 horní

1

48047 náhradní tryska Ø 1,7 mm

1

**FESTA****PIŠTOLE  
STRÍKACÍ**

Ø 1,4 mm



Č.p.

specifikace

48022 horní

1

48046 náhradní tryska Ø 1,5 mm

1

## FESTA

### PISTOLE STRÍKACÍ



Č.p. specifikace  
48030 dolní 1



### PISTOLE STRÍKACÍ NA BARVY A OMÍTKY

- doporučený tlak 4 - 6 Bar
- objem nádoby 5 l
- průměr trysky 4; 6; 8 mm

Č.p. specifikace  
48037 1



## FESTA

### PISTOLE OFUKOVACÍ S NÁSTAVCI

- 25 mm
- 90 mm
- 190 mm

Č.p. specifikace  
48004 10



· 190 mm

· 90 mm

Ø 8,5 mm

## FESTA

### PISTOLE OFUKOVACÍ

Č.p. specifikace  
48005 krátká 25



## FESTA

### PISTOLE OFUKOVACÍ

Č.p. specifikace  
48006 střední 25



## FESTA

### PISTOLE OFUKOVACÍ

Č.p. specifikace  
48007 dlouhá 25



## FESTA

### PISTOLE STRÍKACÍ

Č.p. specifikace  
48015 spodní 1



## FESTA

### PISTOLE NA SPODKY A DUTINY

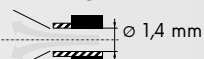

Č.p. specifikace  
48036 spodní 1





**FESTA**

**PISTOLE FOUKACÍ S DIGITÁLNÍM MANOMETREM**

- 0 - 10 bar
- LCD display
- bar, kPa, Psi, kgf/cm<sup>2</sup>

2x AAA

Č.p.	specifikace	
48011	0 - 10 bar	10



**FESTA**

**PISTOLE FOUKACÍ S MANOMETREM**

Č.p.	specifikace	
48010		1



**FESTA**

**KOMPRESOROVÁ SADA**

5x

- 1. postřikovací pistole se spodním nádržkou
- 2. foukací pistole s nanometrem
- 3. postřikovací pistole s horní nádržkou
- 4. ofukovací pistole
- 5. hadice s rychlospojkami

Č.p.	specifikace	
48001		1



**FESTA**

**KOMPRESOROVÁ SADA**

3x

- 1. foukací pistole s nanometrem
- 2. ofukovací pistole
- 3. hadice s rychlospojkami

Č.p.	specifikace	
48002		1

**NEW**

**ADAPTÉRY KE KOMPRESORU**

8x

Č.p.	specifikace	
48013		1



**FESTA**

**HADICE S RYCHLOSPOJKAMI**

Č.p.	specifikace	světlost	
48043	5 m 8 atm	ø 10 mm	1



**FESTA**

**HADICE S RYCHLOSPOJKAMI**

Č.p.	specifikace	světlost	
48040	5 m 8 atm	ø 8 mm	1
48041	10 m 8 atm	ø 8 mm	1
48042	15 m 8 atm	ø 8 mm	1



**FESTA**

**HADICE TLAKOVÁ S RYCHLOSPOJKAMI**

Č.p.	specifikace	
48031	5 m ø 9/15 mm	1
48032	10 m ø 9/15 mm	1
48033	15 m ø 9/15 mm	1
48034	20 m ø 9/15 mm	1

## FESTA

### FILTR

· maximální tlak 10 bar



Č.p.	specifikace	
48008	G 1/4'	1

## FESTA

### REGULÁTOR TLAKU S MANOMETREM

· pracovní tlak 0 - 10 bar



Č.p.	specifikace	
48009	G 1/4'	1

## FESTA

### TRYSKA NÁHRADNÍ

· vhodné pro 48021



Č.p.	specifikace	
48047	tryska Ø 1,7 mm	1

## FESTA

### TRYSKA NÁHRADNÍ

· vhodné pro 48022



Č.p.	specifikace	
48046	tryska Ø 1,5 mm	1

## TABULKA ROZMĚRŮ TRUBKOVÝCH ZÁVITŮ WHITWORTH

VELIKOST ZÁVITU G V PALCÍCH	MAXIMÁLNÍ VNĚJŠÍ Ø ZÁVITU V MM
1/8	9,728
1/4	13,157
3/8	16,662
1/2	20,955
3/4	26,441
1	33,249

### RYCHLOSPOJKA

Č.p.	specifikace	
48075	1/4' vnější	10
48076	3/8' vnější	10
48077	1/2' vnější	10
48095	1/4' vnitřní	10
48096	3/8' vnitřní	10
48097	1/2' vnitřní	10

### ŠROUBENÍ S VNĚJŠÍMI ZÁVITY

Č.p.	specifikace	
48050	spojka 1/4' vnější x 1/4' vnější	10
48051	redukce 1/4' vnější x 3/8' vnější	10

### REDUKCE

Č.p.	specifikace	
48054	3/8' vnější x 1/4' vnitřní	10
48055	1/2' vnější x 3/8' vnitřní	10
48056	redukce 3/8' vnější x 1/2' vnitřní	10
48057	redukce 1/4' vnější x 3/8' vnitřní	10

### ADAPTÉR RYCHLOSPOJKY

Č.p.	specifikace	
48080	1/4' vnější	10
48081	3/8' vnější	10
48090	3/8' vnitřní	10
48091	1/4' vnitřní	10

### ADAPTÉR RYCHLOSPOJKY / HADICOVÁ VSUVKA

Č.p.	specifikace	
48085	1/4' - 6 mm	10
48086	3/8' - 9 mm	10
48087	1/2' - 13 mm	10

### HADICOVÁ VSUVKA

Č.p.	specifikace	
48060	Ø 6 mm - 1/8' vnější	10
48061	Ø 6 mm - 1/4' vnější	10
48062	Ø 6 mm - 3/8' vnější	10
48063	Ø 9 mm - 1/4' vnější	10
48064	Ø 9 mm - 3/8' vnější	10
48065	Ø 13 mm - 1/4' vnější	10
48066	Ø 13 mm - 3/8' vnější	10
48067	Ø 6 mm - 3/8' vnitřní	10
48068	Ø 9 mm - 3/8' vnitřní	10
48093	Ø 6 mm - 1/4' vnitřní	10
48094	Ø 9 mm - 1/4' vnitřní	10

### RYCHLOSPOJKA / HADICOVÁ VSUVKA

Č.p.	specifikace	
48070	1/4' - 6 mm	10
48071	3/8' - 9 mm	10
48072	1/2' - 13 mm	10



**FESTA**  
POWER X TOOLS

### PISTOLE HORKOVZDUŠNÁ S REGULACÍ TEPLoty

napětí / frekvence	230V / 50Hz
příkon	2000W
poloha spínače	0 - I (350°C) - II (550°C)
příslušenství	nerezové nástavce - 4 ks



Č.p. specifikace  
35320 2000 W

1



· digitální display

**FESTA**  
POWER X TOOLS

### PISTOLE HORKOVZDUŠNÁ S REGULACÍ TEPLoty A PROUDU VZDUCHU

napětí / frekvence	230V / 50Hz
příkon	2000W
poloha spínače	0 - I (50°C) - II (50 - 600°C)
proud vzduchu	120 - 500 l/min.
příslušenství	nerezové nástavce - 4 ks



Č.p. specifikace  
35322 2000 W

1

**NEW**



**WEST  
BERG**

### PÁJEČKA TRANSFORMÁTOROVÁ

**230V**  
~ 50Hz **175W**



Č.p. Specifikace

28275 1  
28278 špičky pájecí 3ks 1



**NEW**



**WEST  
BERG**

### PÁJEČKA HROTOVÁ

**230V**  
~ 50Hz **60W**



Č.p. Specifikace

28280 1  
28282 hroty pájecí 2ks 1

**FESTA**  
 POWER X TOOLS

**PISTOLE TAVNÁ  
 BEZDRÁTOVÁ**

· Ø tavné tyčinky 11,2 mm

**230V**  
 ~ 50Hz

**80W**

Č.p. specifikace

**89975**
**20**

**NEW**

**FESTA**  
 POWER X TOOLS

**PISTOLE  
 TAVNÁ**

· Ø tavné tyčinky 7,2 mm

**230V**  
 ~ 50Hz

**12W**

Č.p. Specifikace

**89775**
**1**

**PISTOLE  
 TAVNÁ**

· Ø tavné tyčinky 7,2 mm

**230V**  
 ~ 50Hz

**15W**

Č.p. specifikace

**89970**
**25**

**PISTOLE  
 TAVNÁ**

· Ø tavné tyčinky 11,2 mm

**230V**  
 ~ 50Hz

**60W**

Č.p. specifikace

**89973**
**20**

**TYČINKY DO TAVNÉ PISTOLE**

Č.p.	Ø tyčinky	délka	ks	kg	box
<b>89980</b>	7,2 mm	100 mm	12 ks	100	
<b>89988</b>	7,2 mm	100 mm	1 kg	25	

**TYČINKY DO TAVNÉ PISTOLE**

Č.p.	Ø tyčinky	délka	ks	kg	box
<b>89985</b>	11,2 mm	200 mm	10 ks	50	
<b>89987</b>	11,2 mm	200 mm	1 kg	25	

**TYČINKY DO TAVNÉ PISTOLE**

Č.p.	Ø tyčinky	délka	ks	kg	box
<b>89989</b>	7,2 mm	100 mm	12 ks	100	
<b>89990</b>	11,2 mm	200 mm	10 ks	50	



## TOPIDLO ELEKTRICKÉ

napětí	230V ~50Hz
výkon	3300W
proudové zatížení	14.5A
nastavení výkonu	30/1650/3300W
teplotní rozsah	5-40°C
krytí	IP24
rozměry	27 x 25.5 x 40cm
hmotnost	4.8 kg



- rychlé a efektivní vytápění sklepů, dílen, obchodů, party stanů, skleníků atd.
- nespotebovává kyslík
- bezpečný provoz, plynulá regulace výkonu, prostorový termostat, ventilátor
- topné těleso z nerezavějící oceli
- možnost letního využití pro ventilaci bez ohřevu
- nízká hladina hluku
- kvalitní zpracování, materiály, robustní ocelová konstrukce, snadná a bezpečná manipulace, dlouhá životnost



Č.p.	specifikace
35833	3,3 kW



1

## TOPIDLO PLYNOVÉ

plyn	G30-I3B/P
tlak plynu	0.7bar
jmenovité napětí	230V 50Hz
výkon motoru	25W
maximální spotřeba plynu	1.11 Kg/h
maximální tepelný výkon	15KW
maximální objem horkého vzduchu	300m <sup>3</sup> /h

- rychlé a efektivní vytápění při stavebních pracích, v dílnách atd.
- spotřebovává kyslík!
- přímý ohřev vzduchu s nucenou cirkulací – rychlý nástup tepla
- bezpečný provoz, plynulá regulace výkonu
- termostat a bezpečnostní ventil proti přehřátí a úniku plynu
- včetně příslušenství – regulátor a přívodní plynová hadice
- kvalitní zpracování, materiály, robustní ocelová konstrukce, snadná a bezpečná manipulace, dlouhá životnost



Č.p.	specifikace
35845	15 kW



1

## TOPIDLO PLYNOVÉ

plyn	g30-i3b/p
tlak plynu	1.5bar
jmenovité napětí	230v 50hz
výkon motoru	70w
maximální spotřeba plynu	2.2kg/h
maximální tepelný výkon	30kw
maximální objem horkého vzduchu	750m <sup>3</sup> /h

- rychlé a efektivní vytápění při stavebních pracích, v dílnách atd.
- spotřebovává kyslík!
- přímý ohřev vzduchu s nucenou cirkulací – rychlý nástup tepla
- bezpečný provoz, plynulá regulace výkonu
- termostat a bezpečnostní ventil proti přehřátí a úniku plynu
- včetně příslušenství – regulátor a přívodní plynová hadice
- kvalitní zpracování, materiály, robustní ocelová konstrukce, snadná a bezpečná manipulace, dlouhá životnost



Č.p.	specifikace
35850	30 kW



1



**FESTA**

**SVĚTLO STAVEBNÍ LED**



Č.p.	specifikace	
37611		1



**FESTA**

**SVĚTLO STAVEBNÍ LED**

· maximální výška 180 cm

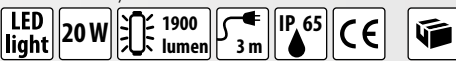

Č.p.	specifikace	
37615	20 W	1
37616	2 x 20 W	1



**NEW**



**FESTA**  
INDUSTRY

**KABEL PRODLUŽOVACÍ S NAVIJÁKEM**

- guma - IP44
- H07RN-F3G - 2,5mm<sup>2</sup>
- vybavený tepelnou pojistkou
- 16 A max. / 3680 W max.
- 4 zásuvky

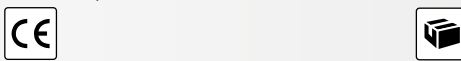

Č.p.	specifikace	
37740	délka 25 m, 2,5 mm <sup>2</sup>	2
37741	délka 50 m, 2,5 mm <sup>2</sup>	2

**NEW**



**FESTA**  
INDUSTRY

**KABEL PRODLUŽOVACÍ S NAVIJÁKEM**

- guma - IP44
- H05RR-F3G - 1,5mm<sup>2</sup>
- vybavený tepelnou pojistkou
- 16 A max. / 3680 W max.
- 4 zásuvky

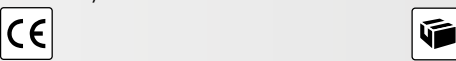

Č.p.	specifikace	
37750	délka 25 m, 1,5 mm <sup>2</sup>	2
37751	délka 50 m, 1,5 mm <sup>2</sup>	2



**FESTA**

**KABEL PRODLUŽOVACÍ S NAVIJÁKEM**

- IP20
- H05VV - F3G - 1,5mm<sup>2</sup>
- vybavený tepelnou pojistkou
- výkon v navinutém stavu : 1000 W max.
- výkon v rozvinutém stavu : 3000 W max.
- 4 zásuvky



Č.p.	specifikace	
37760	délka 25 m, 1,5 mm <sup>2</sup>	2
37761	délka 50 m, 1,5 mm <sup>2</sup>	2

**FESTA**  
INDUSTRY

**KABEL PRODLUŽOVACÍ**

- guma - IP44
- H07RN-F3G - 1,5mm<sup>2</sup>
- 16 A max. / 3680 W max.



Č.p.	specifikace	
37744	délka 5 m, 1,5 mm <sup>2</sup>	8
37745	délka 10 m, 1,5 mm <sup>2</sup>	4
37746	délka 20 m, 1,5 mm <sup>2</sup>	8
37747	délka 30 m, 1,5 mm <sup>2</sup>	8

**NEW**

**FESTA**

**KABEL PRODLUŽOVACÍ**

- IP20
- H05VV-F3G - 1,5mm<sup>2</sup>
- 16 A max. / 3680 W max.



Č.p.	specifikace	
37730	délka 10 m, 1,5 mm <sup>2</sup>	8
37731	délka 20 m, 1,5 mm <sup>2</sup>	4
37732	<b>NEW</b> délka 30 m, 1,5 mm <sup>2</sup>	8
37733	<b>NEW</b> délka 40 m, 1,5 mm <sup>2</sup>	4





VRTÁKY, ŘEZNÉ  
A BRUSNÉ NÁSTROJE 54 - 93



**FESTA**

## VRTÁK VYBRUŠOVANÝ DO KOVU HSS-G COBALT 5 %

Co 5%, W 6%  
Mo 5%, Cr 4%, V 4%**HSS****DIN**  
**338****135°****INOX****1400**  
MPa

Č.p.	specifikace	1	Č.p.	specifikace	1	Č.p.	specifikace	1
22510	Ø 1,00 mm	1	22548	Ø 4,80 mm	1	22590	Ø 9,00 mm	1
22515	Ø 1,50 mm	1	22550	Ø 5,00 mm	1	22595	Ø 9,50 mm	1
22520	Ø 2,00 mm	1	22555	Ø 5,50 mm	1	22600	Ø 10,00 mm	1
22525	Ø 2,50 mm	1	22560	Ø 6,00 mm	1	22602	Ø 10,20 mm	1
22530	Ø 3,00 mm	1	22565	Ø 6,50 mm	1	22605	Ø 10,50 mm	1
22532	Ø 3,20 mm	1	22568	Ø 6,80 mm	1	22610	Ø 11,00 mm	1
22535	Ø 3,50 mm	1	22570	Ø 7,00 mm	1	22615	Ø 11,50 mm	1
22540	Ø 4,00 mm	1	22575	Ø 7,50 mm	1	22620	Ø 12,00 mm	1
22542	Ø 4,20 mm	1	22580	Ø 8,00 mm	1	22625	Ø 12,50 mm	1
22545	Ø 4,50 mm	1	22585	Ø 8,50 mm	1	22630	Ø 13,00 mm	1

**FESTA**

## VRTÁK VYBRUŠOVANÝ DO KOVU HSS-G W 9 %

W 9%, Mo 3%  
Cr 4%, V 1%**HSS****DIN**  
**338****INOX****1100**  
MPa

Č.p.	specifikace	10	Č.p.	specifikace	5	Č.p.	specifikace	5	Č.p.	specifikace	3
19530	Ø 1,00 mm	10	19579	Ø 5,90 mm	5	19612	Ø 9,20 mm	5	19639	Ø 11,90 mm	3
19535	Ø 1,50 mm	10	19580	Ø 6,00 mm	5	19613	Ø 9,30 mm	5	19640	Ø 12,00 mm	3
19536	Ø 1,60 mm	10	19585	Ø 6,50 mm	5	19614	Ø 9,40 mm	5	19641	Ø 12,10 mm	3
19537	Ø 1,70 mm	10	19586	Ø 6,60 mm	5	19615	Ø 9,50 mm	3	19642	Ø 12,20 mm	3
19538	Ø 1,80 mm	10	19587	Ø 6,70 mm	5	19616	Ø 9,60 mm	3	19643	Ø 12,30 mm	3
19539	Ø 1,90 mm	10	19588	Ø 6,80 mm	5	19617	Ø 9,70 mm	3	19644	Ø 12,40 mm	3
19540	Ø 2,00 mm	10	19589	Ø 6,90 mm	5	19618	Ø 9,80 mm	3	19645	Ø 12,50 mm	3
19543	Ø 2,30 mm	10	19590	Ø 7,00 mm	5	19619	Ø 9,90 mm	3	19646	Ø 12,60 mm	1
19544	Ø 2,40 mm	10	19591	Ø 7,10 mm	5	19620	Ø 10,00 mm	3	19647	Ø 12,70 mm	1
19545	Ø 2,50 mm	10	19593	Ø 7,30 mm	5	19621	Ø 10,10 mm	3	19648	Ø 12,80 mm	1
19550	Ø 3,00 mm	10	19594	Ø 7,40 mm	5	19622	Ø 10,20 mm	3	19649	Ø 12,90 mm	1
19552	Ø 3,20 mm	10	19595	Ø 7,50 mm	5	19623	Ø 10,30 mm	3	19650	Ø 13,00 mm	1
19554	Ø 3,40 mm	10	19596	Ø 7,60 mm	5	19624	Ø 10,40 mm	3	19651	Ø 13,20 mm R13	1
19555	Ø 3,50 mm	10	19597	Ø 7,70 mm	5	19625	Ø 10,50 mm	3	19652	Ø 13,50 mm R13	1
19557	Ø 3,70 mm	10	19598	Ø 7,80 mm	5	19626	Ø 10,60 mm	3	19653	Ø 14,00 mm R13	1
19559	Ø 3,90 mm	10	19599	Ø 7,90 mm	5	19627	Ø 10,70 mm	3	19654	Ø 14,50 mm R13	1
19560	Ø 4,00 mm	10	19600	Ø 8,00 mm	5	19628	Ø 10,80 mm	3	19655	Ø 15,00 mm R13	1
19562	Ø 4,20 mm	10	19601	Ø 8,10 mm	5	19629	Ø 10,90 mm	3	19656	Ø 15,50 mm R13	1
19564	Ø 4,40 mm	10	19603	Ø 8,30 mm	5	19630	Ø 11,00 mm	3	19657	Ø 16,00 mm R13	1
19565	Ø 4,50 mm	10	19604	Ø 8,40 mm	5	19631	Ø 11,10 mm	3	19658	Ø 16,50 mm R13	1
19567	Ø 4,70 mm	10	19605	Ø 8,50 mm	5	19632	Ø 11,20 mm	3	19659	Ø 17,00 mm R13	1
19568	Ø 4,80 mm	10	19606	Ø 8,60 mm	5	19633	Ø 11,30 mm	3	19660	Ø 17,50 mm R13	1
19570	Ø 5,00 mm	5	19607	Ø 8,70 mm	5	19634	Ø 11,40 mm	3	19661	Ø 18,00 mm R13	1
19574	Ø 5,40 mm	5	19608	Ø 8,80 mm	5	19635	Ø 11,50 mm	3	19662	Ø 18,50 mm R13	1
19575	Ø 5,50 mm	5	19609	Ø 8,90 mm	5	19636	Ø 11,60 mm	3	19663	Ø 19,00 mm R13	1
19576	Ø 5,60 mm	5	19610	Ø 9,00 mm	5	19637	Ø 11,70 mm	3	19664	Ø 19,50 mm R13	1
19577	Ø 5,70 mm	5	19611	Ø 9,10 mm	5	19638	Ø 11,80 mm	3	19665	Ø 20,00 mm R13	1
19578	Ø 5,80 mm	5									

**FESTA**BOX S VYBRUŠOVANÝMI  
VRTÁKY DO KOVU  
HSS-G W 9 %W 9%, Mo 3%  
Cr 4%, V 1%**HSS****DIN**  
**338****INOX****1100**  
MPa

Č.p.	specifikace	1
19669		1
90191	bez vrtáků	1

Č.p.	obsah sady	Č.p.	obsah sady
19530	Ø 1,00 mm 20x	19585	Ø 6,50 mm 15x
19535	Ø 1,50 mm 20x	19590	Ø 7,00 mm 15x
19540	Ø 2,00 mm 20x	19595	Ø 7,50 mm 15x
19545	Ø 2,50 mm 20x	19600	Ø 8,00 mm 15x
19550	Ø 3,00 mm 20x	19605	Ø 8,50 mm 15x
19552	Ø 3,20 mm 20x	19610	Ø 9,00 mm 15x
19555	Ø 3,50 mm 20x	19615	Ø 9,50 mm 15x
19558	Ø 3,80 mm 20x	19620	Ø 10,00 mm 15x
19560	Ø 4,00 mm 30x	19625	Ø 10,50 mm 6x
19562	Ø 4,20 mm 20x	19630	Ø 11,00 mm 6x
19565	Ø 4,50 mm 20x	19635	Ø 11,50 mm 6x
19568	Ø 4,80 mm 20x	19640	Ø 12,00 mm 6x
19570	Ø 5,00 mm 15x	19645	Ø 12,50 mm 6x
19575	Ø 5,50 mm 15x	19650	Ø 13,00 mm 6x
19580	Ø 6,00 mm 30x		

## FESTA

### VRTÁK VYBRUŠOVANÝ DO KOVU

W 4%, Mo 3%  
Cr 4%, V 1%

HSS

DIN  
338

ALU 900 MPa



MOQ

Č.p.	specifikace		Č.p.	specifikace		Č.p.	specifikace		Č.p.	specifikace	
19670	Ø 0,6 mm	10	19703	Ø 4,0 mm	10	19736	Ø 7,3 mm	10	19769	Ø 10,6 mm	5
19671	Ø 0,8 mm	10	19704	Ø 4,1 mm	10	19737	Ø 7,4 mm	10	19770	Ø 10,7 mm	5
19672	Ø 0,9 mm	10	19705	Ø 4,2 mm	10	19738	Ø 7,5 mm	10	19771	Ø 10,8 mm	5
19673	Ø 1,0 mm	10	19706	Ø 4,3 mm	10	19739	Ø 7,6 mm	10	19772	Ø 11,0 mm	5
19674	Ø 1,1 mm	10	19707	Ø 4,4 mm	10	19740	Ø 7,7 mm	10	19773	Ø 11,2 mm	5
19675	Ø 1,2 mm	10	19708	Ø 4,5 mm	10	19741	Ø 7,8 mm	10	19774	Ø 11,3 mm	5
19676	Ø 1,3 mm	10	19709	Ø 4,6 mm	10	19742	Ø 7,9 mm	10	19775	Ø 11,4 mm	5
19677	Ø 1,4 mm	10	19710	Ø 4,7 mm	10	19743	Ø 8,0 mm	10	19776	Ø 11,5 mm	5
19678	Ø 1,5 mm	10	19711	Ø 4,8 mm	10	19744	Ø 8,1 mm	10	19777	Ø 11,6 mm	5
19679	Ø 1,6 mm	10	19712	Ø 4,9 mm	10	19745	Ø 8,2 mm	10	19778	Ø 11,7 mm	5
19680	Ø 1,7 mm	10	19713	Ø 5,0 mm	10	19746	Ø 8,3 mm	10	19779	Ø 11,8 mm	5
19681	Ø 1,8 mm	10	19714	Ø 5,1 mm	10	19747	Ø 8,4 mm	10	19780	Ø 11,9 mm	5
19682	Ø 1,9 mm	10	19715	Ø 5,2 mm	10	19748	Ø 8,5 mm	10	19781	Ø 12,0 mm	5
19683	Ø 2,0 mm	10	19716	Ø 5,3 mm	10	19749	Ø 8,6 mm	5	19782	Ø 12,2 mm	5
19684	Ø 2,1 mm	10	19717	Ø 5,4 mm	10	19750	Ø 8,7 mm	5	19783	Ø 12,5 mm	5
19685	Ø 2,2 mm	10	19718	Ø 5,5 mm	10	19751	Ø 8,8 mm	5	19784	Ø 12,8 mm	5
19686	Ø 2,3 mm	10	19719	Ø 5,6 mm	10	19752	Ø 8,9 mm	5	19785	Ø 12,9 mm	5
19687	Ø 2,4 mm	10	19720	Ø 5,7 mm	10	19753	Ø 9,0 mm	5	19786	Ø 13,0 mm	5
19688	Ø 2,5 mm	10	19721	Ø 5,8 mm	10	19754	Ø 9,1 mm	5	19787	Ø 13,2 mm R13	5
19689	Ø 2,6 mm	10	19722	Ø 5,9 mm	10	19755	Ø 9,2 mm	5	19788	Ø 13,5 mm R13	5
19690	Ø 2,7 mm	10	19723	Ø 6,0 mm	10	19756	Ø 9,3 mm	5	19789	Ø 14,0 mm R13	5
19691	Ø 2,8 mm	10	19724	Ø 6,1 mm	10	19757	Ø 9,4 mm	5	19790	Ø 14,5 mm R13	5
19692	Ø 2,9 mm	10	19725	Ø 6,2 mm	10	19758	Ø 9,5 mm	5	19791	Ø 15,0 mm R13	5
19693	Ø 3,0 mm	10	19726	Ø 6,3 mm	10	19759	Ø 9,6 mm	5	19792	Ø 15,5 mm R13	5
19694	Ø 3,1 mm	10	19727	Ø 6,4 mm	10	19760	Ø 9,7 mm	5	19793	Ø 16,0 mm R13	5
19695	Ø 3,2 mm	10	19728	Ø 6,5 mm	10	19761	Ø 9,8 mm	5	19794	Ø 16,5 mm R13	5
19696	Ø 3,3 mm	10	19729	Ø 6,6 mm	10	19762	Ø 9,9 mm	5	19795	Ø 17,0 mm R13	5
19697	Ø 3,4 mm	10	19730	Ø 6,7 mm	10	19763	Ø 10,0 mm	5	19796	Ø 17,5 mm R13	5
19698	Ø 3,5 mm	10	19731	Ø 6,8 mm	10	19764	Ø 10,1 mm	5	19797	Ø 18,0 mm R13	5
19699	Ø 3,6 mm	10	19732	Ø 6,9 mm	10	19765	Ø 10,2 mm	5	19798	Ø 18,5 mm R13	5
19700	Ø 3,7 mm	10	19733	Ø 7,0 mm	10	19766	Ø 10,3 mm	5	19799	Ø 19,0 mm R13	5
19701	Ø 3,8 mm	10	19734	Ø 7,1 mm	10	19767	Ø 10,4 mm	5	19800	Ø 19,5 mm R13	5
19702	Ø 3,9 mm	10	19735	Ø 7,2 mm	10	19768	Ø 10,5 mm	5	19801	Ø 20,0 mm R13	5

## FESTA

### BOX S VYBRUŠOVANÝMI VRTÁKY DO KOVU HSS 4341

W 4%, Mo 3%  
Cr 4%, V 1%

HSS

DIN  
338

ALU 900 MPa



Č.p.	obsah sady	Č.p.	obsah sady
19673	Ø 1,00 mm 20x	19728	Ø 6,50 mm 20x
19678	Ø 1,50 mm 20x	19733	Ø 7,00 mm 10x
19683	Ø 2,00 mm 20x	19738	Ø 7,50 mm 10x
19688	Ø 2,50 mm 20x	19743	Ø 8,00 mm 10x
19693	Ø 3,00 mm 30x	19748	Ø 8,50 mm 10x
19695	Ø 3,20 mm 30x	19753	Ø 9,00 mm 10x
19698	Ø 3,50 mm 30x	19758	Ø 9,50 mm 10x
19701	Ø 3,80 mm 30x	19763	Ø 10,00 mm 10x
19703	Ø 4,00 mm 30x	19768	Ø 10,50 mm 10x
19705	Ø 4,20 mm 30x	19772	Ø 11,00 mm 10x
19708	Ø 4,50 mm 30x	19776	Ø 11,50 mm 10x
19711	Ø 4,80 mm 30x	19781	Ø 12,00 mm 10x
19713	Ø 5,00 mm 20x	19783	Ø 12,50 mm 10x
19718	Ø 5,50 mm 20x	19786	Ø 13,00 mm 5x
19723	Ø 6,00 mm 20x		

Č.p.	specifikace	
19802		1
90192	bez vrtáků	1

## FESTA

### VRTÁK DO KOVU PRODLOUŽENÝ

W 4%, Mo 3%  
Cr 4%, V 1%

HSS

DIN  
340

ALU



MOQ

Č.p.	specifikace		Č.p.	specifikace		Č.p.	specifikace	
20220	Ø 2,0 mm x 85 mm	1	20245	Ø 4,5 mm x 126 mm	1	20280	Ø 8,0 mm x 165 mm	5
20225	Ø 2,5 mm x 95 mm	1	20250	Ø 5,0 mm x 132 mm	1	20290	Ø 9,0 mm x 175 mm	5
20230	Ø 3,0 mm x 100 mm	1	20255	Ø 5,5 mm x 139 mm	1	20296	Ø 10,0 mm x 184 mm	5
20235	Ø 3,5 mm x 110 mm	1	20260	Ø 6,0 mm x 139 mm	1			
20240	Ø 4,0 mm x 119 mm	1	20270	Ø 7,0 mm x 156 mm	1			

## VRTÁK DO KOVU TIN

• titanový povrch pro zvýšení výkonu a životnosti

**TiN** **HSS** **DIN 338**



Č.p.	specifikace	
20400	Ø 1,0 mm	1
20401	Ø 1,5 mm	1
20402	Ø 2,0 mm	1
20403	Ø 2,5 mm	1
20404	Ø 3,0 mm	1
20405	Ø 3,2 mm	1
20406	Ø 3,5 mm	1
20407	Ø 3,8 mm	1
20408	Ø 4,0 mm	1
20409	Ø 4,2 mm	1
20410	Ø 4,5 mm	1

Č.p.	specifikace	
20411	Ø 4,8 mm	1
20412	Ø 5,0 mm	1
20413	Ø 5,5 mm	1
20414	Ø 6,0 mm	1
20415	Ø 6,5 mm	1
20416	Ø 6,8 mm	1
20417	Ø 7,0 mm	1
20418	Ø 7,5 mm	1
20419	Ø 8,0 mm	1
20420	Ø 8,5 mm	1
20421	Ø 9,0 mm	1

Č.p.	specifikace	
20422	Ø 9,5 mm	1
20423	Ø 10,0 mm	1
20424	Ø 10,2 mm	1
20425	Ø 10,5 mm	1
20426	Ø 11,0 mm	1
20427	Ø 11,5 mm	1
20428	Ø 12,0 mm	1
20429	Ø 12,5 mm	1
20430	Ø 13,0 mm	1

## VRTÁK DO KOVU

**HSS** **DIN 338**

**ALU**



Č.p.	specifikace	
19841	Ø 4,1 mm 5 ks	10
19842	Ø 4,2 mm 5 ks	10
19845	Ø 4,5 mm 5 ks	10
19885	Ø 8,5 mm 1 ks	10
19895	Ø 9,5 mm 1 ks	10



**FESTA**

## VRTÁKY DO KOVU VYBRUŠOVANÉ

W 9%, Mo 3%  
Cr 4%, V 1% **HSS** **DIN 338**

13x



Č.p.	specifikace	
20333	Ø 1,5 - 6,5 mm	20



**FESTA**

## VRTÁKY DO KOVU VYBRUŠOVANÉ

W 9%, Mo 3%  
Cr 4%, V 1% **HSS** **DIN 338**

19x



Č.p.	specifikace	
20334	Ø 1,0 - 10,0 mm	20



**FESTA**

## VRTÁKY DO KOVU VYBRUŠOVANÉ

W 9%, Mo 3%  
Cr 4%, V 1% **HSS** **DIN 338**

25x



Č.p.	specifikace	
20335	Ø 1,0 - 13,0 mm	5



**FESTA**

## VRTÁKY DO KOVU

W 4%, Mo 3%  
Cr 4%, V 1% **HSS** **DIN 338**

13x



Č.p.	specifikace	
20336	Ø 1,5 - 6,5 mm	1



**FESTA**

## VRTÁKY DO KOVU

W 4%, Mo 3%  
Cr 4%, V 1% **HSS** **DIN 338**

19x



Č.p.	specifikace	
20337	Ø 1,0 - 10,0 mm	20



**FESTA**

## VRTÁKY DO KOVU

W 4%, Mo 3%  
Cr 4%, V 1% **HSS** **DIN 338**

25x



Č.p.	specifikace	
20338	Ø 1,0 - 13,0 mm	10

## FESTA SADA VRTÁKŮ

TiN



9x

Č.p. specifikace  
20317 Ø 5-6-8 mm



20



## FESTA

### VRTÁKY S ŠESTIHRANNOU STOPKOU



1/4"

HSS



ALU

7x

Č.p. specifikace  
20316 Ø 1,5-2-3-4-5-5,5-6 mm



20

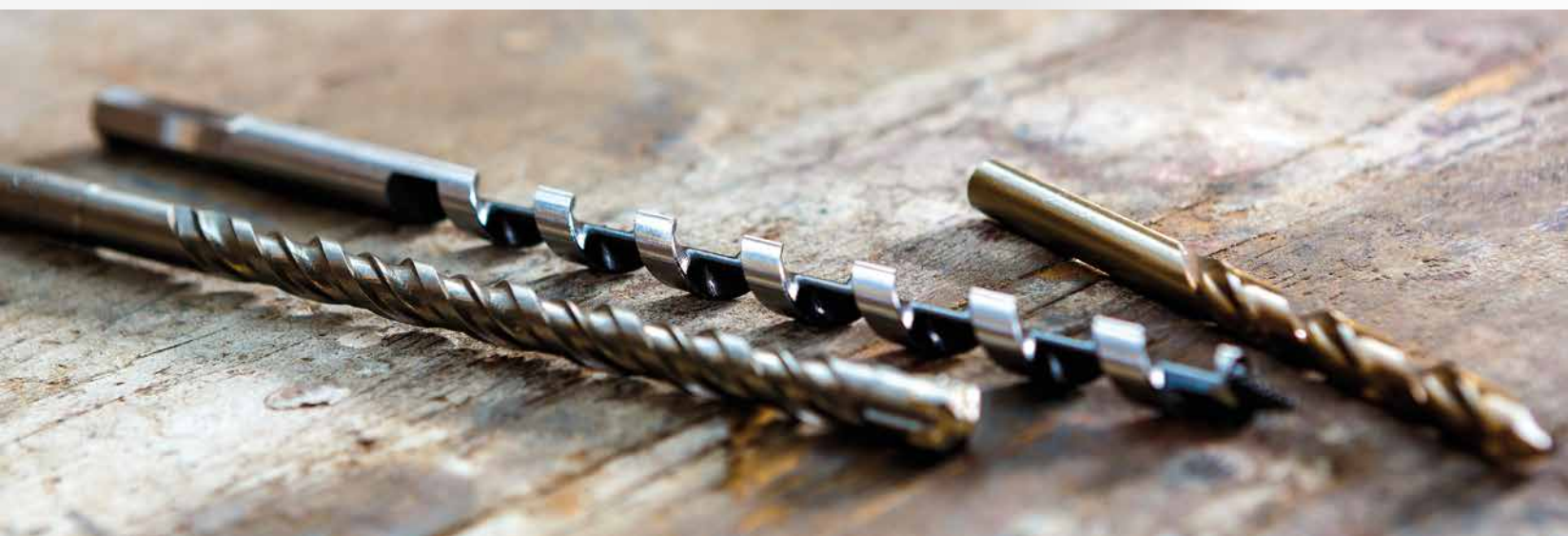

## VRTÁKY DO KOVU

HSS DIN 338



19x

Č.p. specifikace  
20305 Ø 1,0 - 10,0 mm

25



## VRTÁKY DO KOVU

HSS DIN 338



25x

Č.p. specifikace  
20311 Ø 1,0 - 13,0 mm

10



## VRTÁKY DO KOVU

HSS DIN 338



13x

Č.p. specifikace  
20300 Ø 1,5 - 6,5 mm

50



## VRTÁKY DO KOVU

HSS DIN 338



19x

Č.p. specifikace  
20310 Ø 1 - 13 mm

10



**SADA VRTÁKŮ A BITŮ**

vrtáky do dřeva Ø 3 · 4 · 5 · 6 · 8 mm  
 vrtáky do kovu Ø 1 · 1,5 · 2 · 2,5 · 3 · 3,5 · 4 · 4,5 · 5 · 5,5 · 6 · 7 · 8 · 10 mm  
 vrtáky do zdi Ø 4 · 5 · 6 · 8 · 10 mm  
 vrtáky do dřeva ploché Ø 16 · 22 · 25 mm  
 vykrúžovací pily Ø 32 · 38 · 44 · 54 mm  
 hloubkové dorazy Ø 6 · 8 · 10 mm  
 důlčák

měrka na měření průměru vrtáku

bity 25 mm ⊖ S 3 · 4 · 4 · 5 · 5 · 6 · 6 · 7  
 ⊕ PH 0 · 0 · 1 · 1 · 2 · 2 · 2 · 3 · 3  
 ✱ PZ 0 · 0 · 1 · 1 · 2 · 2 · 2 · 3 · 3  
 ● H 2 · 2,5 · 3 · 3,5 · 4 · 5 · 6  
 ✱ T 10 · 15 · 20 · 25 · 27 · 30 · 40

bity 50 mm ⊖ S 4 · 5 · 6 · 6  
 ⊕ PH 1 · 2 · 2 · 3  
 ✱ PZ 1 · 2 · 2 · 3

šroubovací nástavec ○ 4 · 5 · 6 · 7 · 8 · 9 · 10 · 13 mm  
 odjehlovací fréza  
 nástavec na bity

100x



**VRTÁKY DO KOVU**

HSS DIN 338



19x

Č.p.	specifikace	1	Č.p.	specifikace	10
20340			20315	Ø 1 - 10 mm	

**VRTÁKY DO KOVU**

TiN HSS DIN 338



19x



**VRTÁKY DO KOVU**

HSS DIN 338



19x



Č.p.	specifikace	30	Č.p.	specifikace	5	Č.p.	specifikace	20
20320	Ø 1 - 10 x 0,5 mm		20321	Ø 1 - 10 x 0,5 mm		20380	pro Ø 3,5 - 10 mm	



**OSTŘIČ VRTÁKŮ**



**FESTA**

**VYKRÚŽOVACÍ KORUNKA BI-METAL**



Č.p.	Specifikace	
24419	Ø 19 mm	1
24420	Ø 20 mm	1
24422	Ø 22 mm	1
24425	Ø 25 mm	1
24429	Ø 29 mm	1
24432	Ø 32 mm	1
24435	Ø 35 mm	1
24437	Ø 37 mm	1
24444	Ø 44 mm	1
24451	Ø 51 mm	1
24457	Ø 57 mm	1
24464	Ø 64 mm	1
24468	NEW Ø 68 mm	1
24476	Ø 76 mm	1
24483	Ø 83 mm	1



**FESTA**

**UNAŠEČ PRO VYKRÚŽOVACÍ KORUNKY**

Č.p.	specifikace	1
24410	pro korunky 14 - 30 mm	



**FESTA**

**UNAŠEČ PRO VYKRÚŽOVACÍ KORUNKY**

Č.p.	specifikace	1
24411	pro korunky 32 - 152 mm	



**FESTA**

**NÁHRADNÍ VRTÁK PRO UNAŠEČ NA VYKRÚŽOVACÍ KORUNKY**

Č.p.	specifikace	5
24412	pro 24410, 24411	



## FESTA

VYKRUŽOVACÍ  
KORUNKY BI-METAL  
SADA



9x

Č.p.	specifikace
24750	Ø 19, 22, 29, 38, 44, 57 mm



10



## FESTA

VYKRUŽOVACÍ  
KORUNKY BI-METAL  
SADA



13x

Č.p.	specifikace
24751	Ø 19, 22, 29, 35, 38, 44, 51, 57, 64 mm



10



## FESTA

VRTÁK  
STUPŇOVITÝ TIN

TiN HSS



Č.p.	specifikace
20489	Ø 4 - 12 mm 9 stupňů 20
20490	Ø 4 - 20 mm 9 stupňů 10
20491	Ø 5 - 35 mm 13 stupňů 10
20492	Ø 7 - 40,5 mm 13 stupňů 5



## FESTA

SADA  
STUPŇOVITÝCH VRTÁKŮ TIN

TiN HSS



3x

Č.p.	specifikace
20495	Ø 4 - 12, 4 - 20, 4 - 32 mm



1



VRTÁK STUPŇOVITÝ

HSS



Č.p.	specifikace
20487	Ø 4 - 20 mm 9 stupňů 10
20488	Ø 5 - 35 mm 13 stupňů 10
20494	Ø 4 - 32 mm 15 stupňů 10
20493	Ø 7 - 40,5 mm 13 stupňů 1



SADA STUPŇOVITÝCH VRTÁKŮ

HSS



3x

Č.p.	specifikace
20496	Ø 4 - 12, 4 - 20, 4 - 32 mm



1



**FESTA**

### VYTAHOVÁK ZALOMENÝCH ŠROUBŮ - SADA

Ø 4 mm    Ø 11 mm  
 Ø 4,5 mm    Ø 15 mm  
 Ø 6,5 mm    Ø 19 mm  
 Ø 7,5 mm    Ø 24 mm

**8x**

Č.p. specifikace

20387



5

**FESTA**

### VYTAHOVÁK ZALOMENÝCH ŠROUBŮ - SADA

Ø 4 mm  
 Ø 4,5 mm  
 Ø 6 mm  
 Ø 7,5 mm  
 Ø 11 mm

**5x**

Č.p. specifikace

20386



10



### VYTAHOVÁK ZALOMENÝCH ŠROUBŮ - SADA

Ø 4 mm  
 Ø 4,5 mm  
 Ø 6 mm  
 Ø 7,5 mm  
 Ø 11 mm

**5x**

Č.p. specifikace

20385



10

**FESTA**

### DRŽÁK NA ZÁVITOVÁ OČKA

**DIN 225**

Č.p. specifikace

20396 25 x 9 mm



10



### VRATIDLO RÁČNOVÉ NA ZÁVITNÍKY

Č.p. specifikace

20397 M3 - M8



10

**FESTA**

### VRATIDLO STAVITELNÉ

**DIN 1814**

Č.p. specifikace

20394 M5 - M20

20395 1 - 1/2; M3 - M12



10

10

**FESTA**

### ZÁVITNÍKY A ZÁVITOVÁ OČKA SADA

**32x**

Č.p. specifikace

20391 M 3, 4, 5, 6, 8, 10, 12 mm



1

**FESTA**

### ZÁVITNÍKY SADA

**21x**

Č.p. specifikace

20390 M 3, 4, 5, 6, 8, 10, 12 mm



1

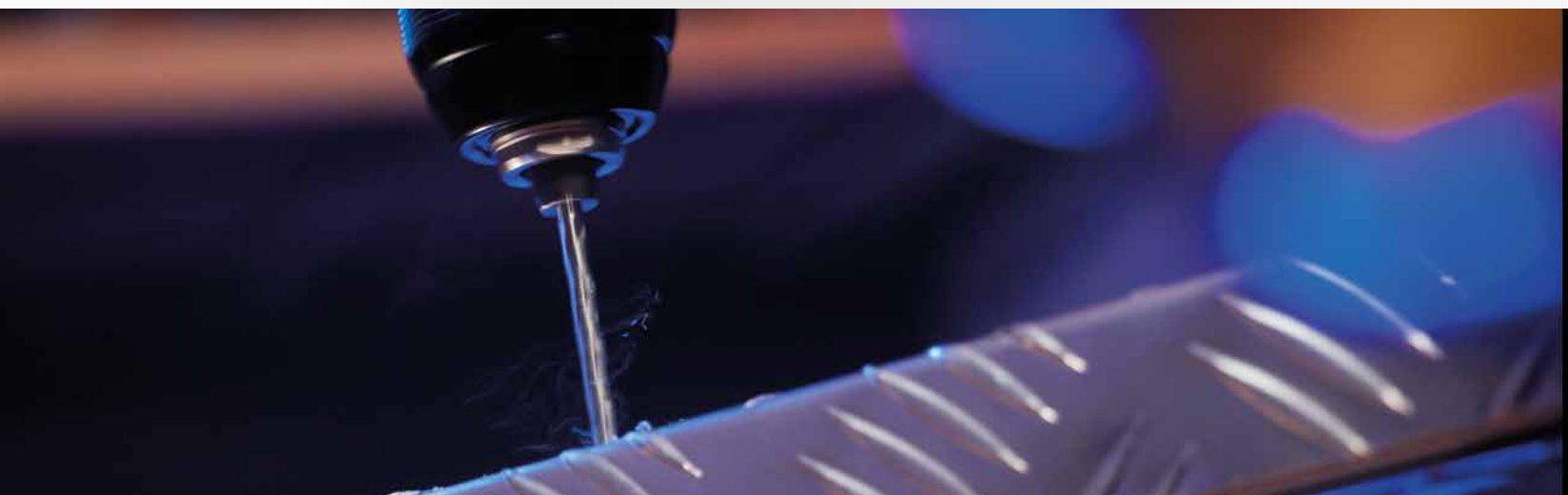

**NEW**

**FESTA**

SUKOVNÍK

TC



Č.p.	Specifikace	
21531	Ø 15 mm	1
21532	Ø 20 mm	1
21533	Ø 25 mm	1
21534	Ø 30 mm	1
21535	Ø 35 mm	1
21536	Ø 40 mm	1



**FESTA**

**FESTA**

VRTÁK HADOVITÝ DO DŘEVA



Č.p.	specifikace	
20980	Ø 6 x 230 mm	1
20957	Ø 6 x 300 mm	1
20981	Ø 8 x 230 mm	1
20958	Ø 8 x 300 mm	1
20982	Ø 10 x 230 mm	1
20896	Ø 10 x 300 mm	1
20913	Ø 10 x 450 mm	1
20983	Ø 12 x 230 mm	1
20897	Ø 12 x 300 mm	1
20915	Ø 12 x 450 mm	1
20920	Ø 12 x 600 mm	1
20898	Ø 14 x 300 mm	1
20916	Ø 14 x 450 mm	1
20921	Ø 14 x 600 mm	1

Č.p.	specifikace	
20984	Ø 16 x 230 mm	1
20899	Ø 16 x 300 mm	1
20917	Ø 16 x 450 mm	1
20922	Ø 16 x 600 mm	1
20918	Ø 18 x 450 mm	1
20923	Ø 18 x 600 mm	1
20919	Ø 20 x 450 mm	1
20924	Ø 20 x 600 mm	1
20724	Ø 22 x 450 mm	1
20725	Ø 24 x 450 mm	1
20726	Ø 26 x 450 mm	1
20727	Ø 28 x 450 mm	1
20728	Ø 30 x 450 mm	1

**FESTA**

VRTÁKY HADOVITÉ DO DŘEVA SADA



5x

Č.p.	specifikace	
20911	Ø 8, 10, 12, 14, 16 x 460 mm	10



**FESTA**

VRTÁKY HADOVITÉ DO DŘEVA - SADA



6x

Č.p.	specifikace	
20912	Ø 6, 8, 10, 12, 16, 20 x 230 mm	10



VRTÁK DO DŘEVA



Č.p.	specifikace	
20729	Ø 6 x 400 mm	1
20731	Ø 8 x 400 mm	1
20736	Ø 8 x 600 mm	1
20730	Ø 10 x 400 mm	1
20737	Ø 10 x 600 mm	1



Č.p.	specifikace	
20732	Ø 12 x 400 mm	1
20738	Ø 12 x 600 mm	1
20733	Ø 14 x 400 mm	1
20739	Ø 14 x 600 mm	1

Č.p.	specifikace	
20734	Ø 16 x 400 mm	1
20740	Ø 16 x 600 mm	1
20735	Ø 18 x 400 mm	1
20741	Ø 18 x 600 mm	1



**FESTA**

**VRTÁK NA KONFIRMÁTY VYBRUŠOVANÝ**

**HSS**

Č.p.	specifikace	
20210	Ø 7,5, 5 mm	1



**VRTÁK DO DŘEVA**



Č.p.	specifikace	
21440	Ø 4 x 75 mm	1
21441	Ø 5 x 85 mm	1
21442	Ø 6 x 90 mm	1
21443	Ø 7 x 105 mm	1
21444	Ø 8 x 115 mm	1
21445	Ø 9 x 120 mm	1
21446	Ø 10 x 120 mm	1



**VRTÁK FRÉZOVACÍ**

**HSS TiN**



Č.p.	specifikace	
20460	Ø 6 mm	50



**VRTÁK DO DŘEVA SADA**



Č.p.	specifikace	
20910	8 ks Ø 3, 4, 5, 6, 7, 8, 9, 10 mm	10
20905	5 ks Ø 4, 5, 6, 8, 10 mm	10



**SUKOVNÍKY - SADA**



**5x**

Č.p.	specifikace	
21530	Ø 15, 20, 25, 30, 35 mm Ø 8 mm	20



**VRTÁKY FRÉZOVACÍ SADA**

**HSS TiN**



**6x**

Č.p.	specifikace	
20450	Ø 3, 4, 5, 6, 6,5, 8 mm	20

**VRTÁKY KOPINATÉ DO DŘEVA - SADA**



**6x**

Č.p.	specifikace	
20901	Ø 10, 12, 16, 18, 20, 25 mm	20



**NEBOZEZY - SADA**

**HOBBY**

**4x**

Č.p.	specifikace	
20381	Ø 2, 3, 4, 5 mm	20





**FESTA**

**PILY VYKRUŽOVACÍ**

- Ø 19 mm
- Ø 22 mm
- Ø 25 mm
- Ø 35 mm
- Ø 44 mm
- Ø 51 mm
- Ø 60 mm
- Ø 67 mm
- Ø 76 mm
- Ø 82 mm
- inbus
- 2x hlavička



**12x**



Č.p.	specifikace	
24712	6 tpi	20



**FESTA**

**PILY VYKRUŽOVACÍ**

- Ø 64 mm
- Ø 76 mm
- Ø 89 mm
- Ø 102 mm
- Ø 127 mm
- inbus
- hlavička



**8x**



Č.p.	specifikace	
24706	6 tpi	20



**FESTA**  
**KORUNKA VYKRUŽOVACÍ NASTAVITELNÁ**

Ø 19 - 127 mm



Č.p.	Specifikace	
24415	Ø 19 - 127 mm max. hloubka 29 mm	6

**FESTA**

**VYKRUŽOVACÍ PILA NA DŘEVO A SÁDROKARTON**



Č.p.	specifikace	
24715	1' Ø 67 mm 6 tpi	5
24713	1' Ø 73 mm 6 tpi	5
24714	1' Ø 102 mm 6 tpi	5
24720	1' Ø 152 mm 6 tpi	5



**VYKRUŽOVACÍ PILY - SADA**



Č.p.	specifikace	
24721	1' Ø 26, 32, 38, 45, 50, 56, 63 mm	10
24722	2' Ø 26, 32, 38, 45, 50, 56, 63 mm	10

**VYKRUŽOVÁK STAVITELNÝ**



Č.p.	specifikace	
24716	Ø 30 - 120 mm	5

**FESTA**

**RAŠPLE VÁLCOVÁ**

**M14**

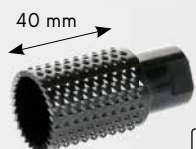

Č.p.	Specifikace	
21807	Ø 30 mm / 60 mm	1

**FESTA**

**RAŠPLE KULOVÁ**

**M14**



Č.p.	Specifikace	
21808	Ø 30 mm / 105 mm	10



ROTAČNÍ RAŠPLE

5x



Č.p. specifikace 21541 25



ROTAČNÍ BRUSKY

5x



Č.p. specifikace 21540 Ø 3 mm, 6 mm 12

NÁSTAVCE NA PŘÍMOU BRUSKOU

190x



Č.p. specifikace 24755 5

NÁSTAVCE NA PŘÍMOU BRUSKOU

150x



Č.p. specifikace 24756 10



TVAROVÉ FRÉZY DO DŘEVA



5x



Č.p. specifikace 21450 Ø 8 mm 10



TVAROVÉ FRÉZY DO DŘEVA



12x



Č.p. specifikace 21451 Ø 8 mm 10



TVAROVÉ FRÉZY DO DŘEVA



24x



Č.p. specifikace 21452 Ø 8 mm 1

TVAROVÉ FRÉZY DO DŘEVA



35x



Č.p. specifikace 21453 Ø 8 mm 1

TVAROVÉ FRÉZY DO DŘEVA



59x



Č.p. specifikace 21454 Ø 8 mm 1

## FESTA

### VRTÁK PŘÍKLEPOVÝ VIDIOVÝ

DIN 8039



· dvoubřítý vrták



Č.p.	specifikace	A mm	B mm	
20673	Ø 3 mm	60	30	100
20674	Ø 4 mm	75	40	100
20675	Ø 5 mm	85	50	100
20676	Ø 6 mm	100	60	100
20677	Ø 6 mm	200	160	50
20685	Ø 6 mm	300	260	50
20678	Ø 8 mm	120	75	50
20686	Ø 8 mm	200	155	50

Č.p.	specifikace	A mm	B mm	
20687	Ø 8 mm	300	255	25
20688	Ø 8 mm	400	340	25
20680	Ø 10 mm	120	70	50
20690	Ø 10 mm	200	150	50
20691	Ø 10 mm	300	250	25
20692	Ø 10 mm	400	340	25
20682	Ø 12 mm	150	100	50
20694	Ø 12 mm	300	250	25

Č.p.	specifikace	A mm	B mm	
20696	Ø 12 mm	400	340	25
20684	Ø 14 mm	150	90	25
	redukce Ø 10 mm			
20697	Ø 14 mm	300	240	5
	redukce Ø 10 mm			
20698	Ø 14 mm	400	340	15
	redukce Ø 10 mm			

## FESTA

### VRTÁK PŘÍKLEPOVÝ VIDIOVÝ SDS+

SDS+



· dvoubřítý vrták



Č.p.	specifikace	A mm	B mm	
20855	Ø 14 mm	160	75	

Č.p.	specifikace	A mm	B mm	
				25

Č.p.	specifikace	A mm	B mm	
				25

## FESTA

### VRTÁK PŘÍKLEPOVÝ VIDIOVÝ SDS+

SDS+

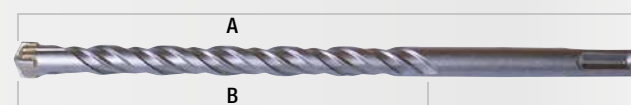

· čtyřbřítý vrták se zvýšenou výkonností a trvanlivostí



Č.p.	specifikace	A mm	B mm	
20748	Ø 6 mm	110	40	50
20749	Ø 6 mm	160	90	50
20750	Ø 6 mm	210	140	50
20751	Ø 6 mm	260	190	50
20861	Ø 6,5 mm	230	160	50
20862	Ø 6,5 mm	300	230	50
20752	Ø 8 mm	110	40	50
20753	Ø 8 mm	160	90	50
20754	Ø 8 mm	210	140	50
20755	Ø 8 mm	260	190	50
20825	Ø 8 mm	350	280	50
20756	Ø 10 mm	160	90	50
20757	Ø 10 mm	210	140	50
20758	Ø 10 mm	260	190	50
20759	Ø 10 mm	350	280	50
20760	Ø 10 mm	450	380	50
20761	Ø 10 mm	600	530	50
20762	Ø 10 mm	1000	930	50
20764	Ø 12 mm	160	80	50
20765	Ø 12 mm	210	130	50
20766	Ø 12 mm	260	180	50
20767	Ø 12 mm	350	270	50

Č.p.	specifikace	A mm	B mm	
20768	Ø 12 mm	460	380	50
20769	Ø 12 mm	600	520	25
20770	Ø 12 mm	1000	920	25
20771	Ø 14 mm	160	80	25
20772	Ø 14 mm	260	180	25
20773	Ø 14 mm	350	270	25
20774	Ø 14 mm	460	380	25
20775	Ø 14 mm	600	520	25
20776	Ø 14 mm	1000	920	30
20777	Ø 16 mm	160	80	25
20778	Ø 16 mm	210	130	25
20779	Ø 16 mm	260	180	25
20780	Ø 16 mm	350	270	25
20781	Ø 16 mm	460	380	25
20782	Ø 16 mm	600	520	30
20783	Ø 16 mm	1000	920	25
20784	Ø 18 mm	260	180	25
20785	Ø 18 mm	450	370	25
20786	Ø 18 mm	600	520	32
20787	Ø 18 mm	1000	920	20
20788	Ø 20 mm	450	370	20
20789	Ø 20 mm	600	520	20

Č.p.	specifikace	A mm	B mm	
20790	Ø 20 mm	800	720	25
20791	Ø 20 mm	1000	920	10
20792	Ø 22 mm	450	365	20
20793	Ø 22 mm	600	520	20
20794	Ø 22 mm	800	715	20
20795	Ø 22 mm	1000	920	10
20796	Ø 24 mm	450	365	10
20797	Ø 24 mm	600	520	20
20798	Ø 24 mm	800	715	10
20799	Ø 24 mm	1000	920	10
20870	Ø 26 mm	450	370	10
20871	Ø 26 mm	650	570	20
20872	Ø 26 mm	800	720	10
20873	Ø 26 mm	1000	920	10
20874	Ø 28 mm	450	365	10
20875	Ø 28 mm	600	565	20
20876	Ø 28 mm	800	715	10
20877	Ø 28 mm	1000	915	10
20878	Ø 30 mm	450	365	10
20879	Ø 30 mm	600	565	20
20880	Ø 30 mm	800	715	10
20881	Ø 30 mm	1000	915	10

## FESTA

### VRTÁK PŘÍKLEPOVÝ VIDIOVÝ SDS MAX

SDS MAX

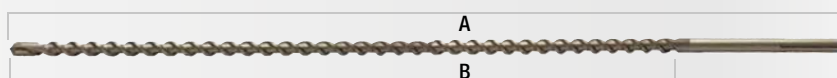

· čtyřbřítý vrták se zvýšenou výkonností a trvanlivostí



Č.p.	specifikace	A mm	B mm	
20508	Ø 16 mm	550	395	5
20510	Ø 18 mm	550	395	5
20520	Ø 18 mm	800	650	5
20511	Ø 20 mm	550	395	5
20521	Ø 20 mm	800	650	5

Č.p.	specifikace	A mm	B mm	
20512	Ø 22 mm	550	395	5
20522	Ø 22 mm	800	650	5
20513	Ø 24 mm	550	395	5
20523	Ø 24 mm	800	650	5
20514	Ø 28 mm	550	395	5

Č.p.	specifikace	A mm	B mm	
20524	Ø 28 mm	800	650	5
20515	Ø 30 mm	550	395	5
20525	Ø 30 mm	800	650	5
20516	Ø 40 mm	550	395	2
20526	Ø 40 mm	800	650	1

SADA VRTÁKŮ  
DO ZDIVA SDS+

5x SDS+



Č.p.	specifikace		
20890	Ø 5, 6, 8, 10, 12 mm	160 mm	25

SADA VRTÁKŮ  
DO ZDIVA SDS+

6x SDS+



Č.p.	specifikace		
20891	Ø 5, 6, 8 mm Ø 8, 10, 12 mm	110 mm 160 mm	25

SADA VRTÁKŮ  
DO ZDIVA6x DIN  
8039

Č.p.	specifikace		
20895	Ø 5, 6, 8, 10, 12 mm		25

SADA VRTÁKŮ  
DO ZDIVA

Č.p.	specifikace		
20805	5 ks Ø 4 - 10 mm		10
20820	8 ks Ø 3 - 10 mm		10

FESTA  
SEKÁČE SADA

SDS+

4x



Č.p.	specifikace		
20954	250 mm		1

STOJAN  
PREZentační

Č.p. specifikace 1

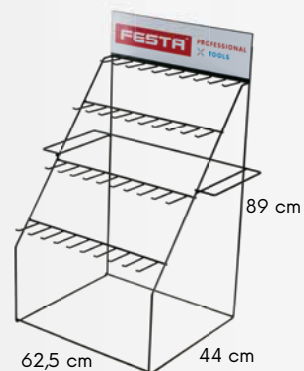

FESTA

SEKÁČE  
A VRTÁKY SDS+

- 2 x špičák
- 3 x sekáč
- 12 x vrták

17x SDS+



Č.p.	specifikace		
20952			1



FESTA

## SEKÁČE A VRTÁKY SDS+

- 1 x špičák 250 mm
- 1 x drážkovač 22 x 250 mm
- 1 x plochý 20 x 250 mm

- Ø 5 x 110 mm
- Ø 6 x 110 mm
- Ø 8 x 160 mm
- Ø 10 x 160 mm
- Ø 12 x 160 mm
- Ø 14 x 210 mm
- Ø 16 x 210 mm
- Ø 18 x 310 mm
- Ø 20 x 450 mm

12x SDS+



Č.p.	specifikace		
20950			5



FESTA

## SEKÁČ SDS +

SDS+



Č.p.	specifikace		
20996	250 x 100 mm		1



**NEW**



**FESTA**  
SEKÁČ SDS +  
SDS+

Č.p.	specifikace	
20997	445 x 130 mm	1

**NEW**

**FESTA**  
SEKÁČ RÝČOVÝ SDS MAX



SDS MAX

Č.p.	specifikace	
20932	450 x 100 mm	1

**FESTA**  
SEKÁČ PLOCHÝ, ZAHNUTÝ 15°

SDS+

Č.p.	specifikace		
20936	40 x 250 mm	5	



**FESTA**  
SEKÁČ

SDS+

Č.p.	specifikace		
20948	20 x 250 mm	25	
20990	20 x 400 mm	25	
20949	40 x 250 mm	25	
20991	40 x 400 mm	25	



**FESTA**  
SEKÁČ

SDS MAX

Č.p.	specifikace		
20940	25 x 280 mm	5	
20941	40 x 280 mm	5	
20942	75 x 280 mm	5	
20943	25 x 400 mm	5	
20944	40 x 400 mm	5	
20945	25 x 600 mm	5	
20946	50 x 600 mm	5	



**FESTA**  
ŠPIČÁK

SDS+

Č.p.	specifikace		
20947	250 mm	25	
20992	400 mm	25	



**FESTA**  
ŠPIČÁK

SDS MAX

Č.p.	specifikace		
20937	Ø 18 x 280 mm	5	
20938	Ø 18 x 400 mm	5	
20939	Ø 18 x 600 mm	2	



**FESTA**  
DRÁŽKOVÁČ

SDS+

Č.p.	specifikace		
20956	22 x 250 mm	25	



**FESTA**  
KORUNKA VYKRUŽOVACÍ S SK PLÁTKY SDS+

• korunka je možné použít se stopkami 24730, 24731 a 24732

SDS+

Č.p.	specifikace		
24719	Ø 67 mm	1	
24717	Ø 73 mm	1	
24723	Ø 80 mm	1	
24718	Ø 100 mm	1	
24757	Ø 115 mm	1	
24758	Ø 125 mm	1	
24759	Ø 150 mm	1	

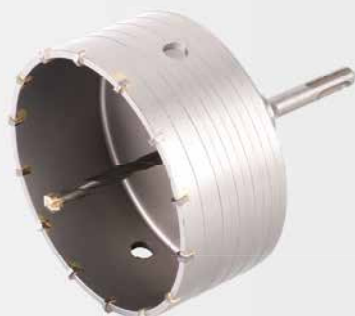

**FESTA**  
STOPKA UPÍNACÍ PRO VYKRUŽOVACÍ KORUNKY

SDS MAX

Č.p.	specifikace		
24730	180 mm	1	



**FESTA**  
STOPKA UPÍNACÍ PRO VYKRUŽOVACÍ KORUNKY

SDS+

Č.p.	specifikace		
24731	300 mm	1	
24732		1	



**FESTA**

## KORUNKY VYKRUŽOVACÍ KARBIDOVÉ - SADA



6x



Č.p.	specifikace	
24745	Ø 33, 53, 67, 73 mm + unašeč, vrták	1

**FESTA**

## VYKRUŽOVACÍ KORUNKY KARBIDOVÉ - SADA



8x

Č.p.	specifikace	
24747	Ø 33, 53, 67, 73, 83 mm unašeč, vrták, pilník	1

**FESTA**

## KORUNKA VYKRUŽOVACÍ KARBIDOVÁ



Č.p.	specifikace	
24735	Ø 33 mm	1
24736	Ø 43 mm	1
24737	Ø 53 mm	1
24738	Ø 67 mm	1
24739	Ø 73 mm	1
24740	Ø 83 mm	1
24741	Ø 103 mm	1

**FESTA**

## KORUNKA VYKRUŽOVACÍ KARBIDOVÁ - SADA

3x



Č.p.	specifikace	
24746	Ø 103 mm + unašeč, vrták	1

**FESTA**

## VRTÁK PRO KORUNKY VYKRUŽOVACÍ



Č.p.	specifikace	
24749		50

**FESTA**

## UNAŠEČ PRO KORUNKY VYKRUŽOVACÍ



Č.p.	specifikace	
24748	Ø 33 - 83 mm	10
24743	Ø 33 - 103 mm	10

**FESTA**

## KORUNKA VRTACÍ KARBIDOVÁ

· pro vrtání do skla a keramiky  
· nutné chlazení



Č.p.	specifikace	
24770	Ø 4 mm	1
24771	Ø 6 mm	1
24772	Ø 8 mm	1
24773	Ø 10 mm	1
24774	Ø 12 mm	1



## VYKRUŽOVÁK STAVITELNÝ S KRYTEM

Č.p.	specifikace	
24726	Ø 20-95mm	1

## VYKRUŽOVÁK STAVITELNÝ

Č.p.	specifikace	
24725	Ø 20-95mm	10

**FESTA**

## PILNÍK NA OBKLADY A DLAŽBU



Č.p.	specifikace	
22200	160 mm	20

**FESTA**

## PILNÍK PLOCHÝ NA OBKLADY, DLAŽBU A ZDIVO

· pro broušení cihel před vložením stěnové kotvy



Č.p.	specifikace	
22201	200 mm dvojí hrubost	20





## SADA VYKRUŽOVACÍCH DIAMANTOVÝCH KORUNEK

- Ø 6 mm
- Ø 8 mm
- Ø 10 mm
- Ø 12 mm
- Ø 20 mm
- Ø 28 mm
- Ø 35 mm
- Ø 45 mm
- Ø 55 mm
- Ø 68 mm

kotouč řezný / brusný Ø 125 mm x 2,0 mm Ø 22,2 mm  
 kotouč řezný Ø 125 mm x 1,2 mm Ø 22,2 mm  
 kuželová korunka brusná Ø 0 - 50 mm  
 diamantová brusná houba 90 x 55 mm P60

**13x M14**

- keramické obklady a dlažba
- mramor
- žula

· použití bez chlazení vodou



Č.p.	Specifikace
24652	

1



## SADA VYKRUŽOVACÍCH DIAMANTOVÝCH KORUNEK

- Ø 6 mm
- Ø 8 mm
- Ø 10 mm
- Ø 20 mm
- Ø 35 mm
- Ø 45 mm
- Ø 55 mm
- Ø 68 mm

**8x M14**

- keramické obklady a dlažba
- mramor
- žula

· použití bez chlazení vodou



Č.p.	Specifikace
24651	

1



## KORUNKA BRUSNÁ DIAMANTOVÁ

**M14**

- keramické obklady a dlažba
- mramor
- žula

· použití bez chlazení vodou



Č.p.	Specifikace
24795	Ø 20 / 50 mm
24797	Ø 6 / 50 mm
24799	Ø 10 / 50 mm

1

1

1



## KORUNKA VYKRUŽOVACÍ DIAMANTOVÁ

**M14**

- keramické obklady a dlažba
- mramor
- žula

· použití bez chlazení vodou



Č.p.	Specifikace	úchyt
24620	Ø 6 mm	M14
24621	Ø 8 mm	M14
24622	Ø 10 mm	M14
24623	Ø 12 mm	M14
24624	Ø 14 mm	M14
24627	Ø 20 mm	M14
24630	Ø 28 mm	M14
24633	Ø 35 mm	M14
24636	Ø 45 mm	M14
24638	Ø 55 mm	M14
24640	Ø 68 mm	M14
24642	NEW Ø 72 mm	M14
24643	Ø 75 mm	M14



## KORUNKA BRUSNÁ DIAMANTOVÁ

**M14**

- keramické obklady a dlažba
- mramor
- žula

· použití bez chlazení vodou



Č.p.	Specifikace
24775	NEW Ø 2 - 35 mm
24777	Ø 2 - 75 mm
24778	Ø 2 - 50 mm

1

1

1



· Ø 2 mm - Ø 75 mm



## KORUNKA BRUSNÁ, DIAMANTOVÁ

M14

- keramické obklady
- mramor
- žula

použití bez chlazení vodou



· Ø 20 mm - Ø 48 mm



Č.p.	Specifikace	
24779	Ø 20 - 48 mm	1



## KORUNKA BRUSNÁ DIAMANTOVÁ

M14

- keramické obklady a dlažba
- mramor
- žula

použití bez chlazení vodou

NEW



Č.p.	Specifikace	
24663	Ø 50 mm	1



## KORUNKA VYKRUŽOVACÍ DIAMANTOVÁ

M14

- keramické obklady
- mramor
- žula

použití bez chlazení vodou



Č.p.	specifikace	úchyt		Č.p.	specifikace	úchyt	
24760	Ø 6 mm	M14	1	24766	Ø 35 mm	M14	1
24761	Ø 8 mm	M14	1	24776	Ø 40 mm	M14	1
24762	Ø 10 mm	M14	1	24767	Ø 45 mm	M14	1
24763	Ø 12 mm	M14	1	24791	Ø 50 mm	M14	1
24764	Ø 14 mm	M14	1	24768	Ø 53 mm	M14	1
24670	Ø 16 mm	M14	1	24792	Ø 60 mm	M14	1
24671	Ø 18 mm	M14	1	24793	Ø 65 mm	M14	1
24790	Ø 20 mm	M14	1	24769	Ø 68 mm	M14	1
24672	Ø 22 mm	M14	1	24794	Ø 75 mm	M14	1
24673	Ø 25 mm	M14	1	24796	Ø 83 mm	M14	1
24765	Ø 28 mm	M14	1	24677	Ø 102 mm	M14	1
24674	Ø 30 mm	M14	1	24676	Ø 110 mm	M14	1
24675	Ø 32 mm	M14	1	24678	Ø 125 mm	M14	1



## KORUNKA BRUSNÁ DIAMANTOVÁ

M14

- keramické obklady a dlažba
- mramor
- žula

použití bez chlazení vodou

NEW



Č.p.	Specifikace	
24661	Ø 50 mm	1



## KORUNKA VYKRUŽOVACÍ DIAMANTOVÁ, SADA

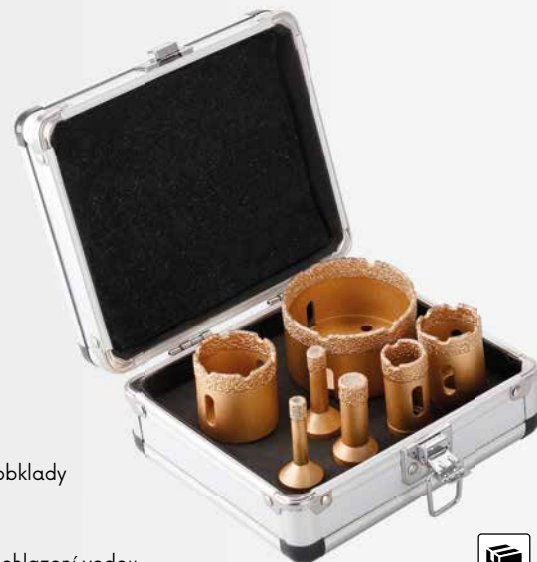

- Ø 8 mm
- Ø 10 mm
- Ø 14 mm
- Ø 22 mm
- Ø 32 mm
- Ø 40 mm
- Ø 68 mm

7x M14

- keramické obklady
- mramor
- žula

použití bez chlazení vodou



Č.p.	Specifikace	
24650		1



## KORUNKA VYKRUŽOVACÍ DIAMANTOVÁ

- keramické obklady
- mramor
- žula



Č.p.	specifikace	
24700	Ø 6 mm	1
24701	Ø 8 mm	1
24702	Ø 10 mm	1
24703	Ø 12 mm	1
24704	Ø 14 mm	1
24705	Ø 20 mm	1



## FESTA

CHLADÍCÍ VOSK  
NA DIAMANTOVÉ  
KORUNKY



Č.p.	Specifikace	
24710	30 ml	1

## FESTA

KORUNKA  
VYKRUŽOVACÍ  
DIAMANTOVÁ  
- SADA

6x

- keramické obklady
- mramor
- žula



Č.p.	specifikace	
24798	Ø 6, 8, 10, 12, 14, 20 mm	1



## FESTA

KOTOUČ  
ŘEZNÝ A BRUSNÝ  
- DIAMANTOVÝ

M14

- keramické obklady
- mramor
- žula

- použití bez chlazení vodou

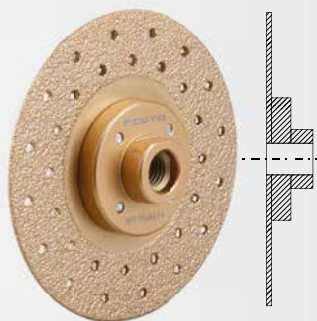

Č.p.	Specifikace	
24655	Ø 115 mm M14	1



## FESTA

KOTOUČ BRUSNÝ  
- DIAMANTOVÝ

- keramické obklady
- mramor
- žula

- použití bez chlazení vodou

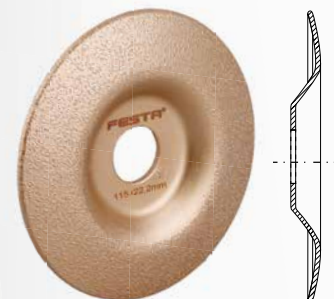

Č.p.	Specifikace	
24658	Ø 115 mm Ø 22,2 mm	1

## FESTA

VRTÁK NA SKLO  
A KERAMIKU

TiN 1/4"

- keramické obklady a dlažba
- mramor
- žula

Č.p.	specifikace	
24780	Ø 4 mm	40
24781	Ø 5 mm	40
24782	Ø 6 mm	40
24783	Ø 8 mm	40
24784	Ø 10 mm	40
24785	Ø 12 mm	40
24786	Ø 14 mm	1
24787	Ø 16 mm	1
24788	Ø 18 mm	1
24789	Ø 20 mm	1



## FESTA

VRTÁKY NA SKLO A  
KERAMIKU, SADA

- Ø 4 mm
- Ø 5 mm
- Ø 6 mm
- Ø 8 mm
- Ø 10 mm

5x

- keramické obklady a dlažba
- mramor
- žula

- použití bez chlazení vodou



Č.p.	Specifikace	
24734		1



**KOTOUČ ŘEZNÝ / BRUSNÝ - DIAMANTOVÝ**

- keramické obklady a dlažba
- mramor
- žula

· použití bez chlazení vodou



Č.p.	Specifikace		
21230	Ø 115 mm x 2,0 mm	Ø 22,2 mm	1
21231	Ø 125 mm x 2,0 mm	Ø 22,2 mm	1



**KOTOUČ ŘEZNÝ - DIAMANTOVÝ - TURBO EXTREME**

- železobeton
- keramické obklady a dlažba
- mramor
- žula

· použití bez chlazení vodou

Č.p.	Specifikace		
21205	Ø 125 mm x 2,0 mm	Ø 22,2 mm	1
21209	Ø 230 mm x 2,6 mm	Ø 22,2 mm	1



**KOTOUČ ŘEZNÝ**

- keramické obklady a dlažba
- mramor
- žula

· použití bez chlazení vodou

Č.p.	Specifikace		
21234 <b>NEW</b>	Ø 115 mm x 1,2 x 8 mm	Ø 22,2 mm	1
21235	Ø 125 mm x 1,2 x 8 mm	Ø 22,2 mm	1
21238 <b>NEW</b>	Ø 200 mm x 1,6 x 11 mm	Ø 25,4 mm	1



**KOTOUČ DIAMANTOVÝ**

- keramické obklady a dlažba
- mramor
- žula

· použití bez chlazení vodou

Č.p.	specifikace		
21200	Ø 115 mm 1,4 mm	Ø 22,2 mm	1
21201	Ø 125 mm 1,4 mm	Ø 22,2 mm	1
21204	Ø 200 mm 1,8 mm	Ø 25,4 mm	1
21203	Ø 230 mm 1,8 mm	Ø 22,2 mm	1

**FESTA**

## KOTOUČ DIAMANTOVÝ SEGMENTOVÝ

Č.p.	specifikace		
21311	Ø 115 mm	Ø 22,2 mm	1
21312	Ø 125 mm	Ø 22,2 mm	1
21315	Ø 150 mm	Ø 22,2 mm	1
21318	Ø 180 mm	Ø 22,2 mm	1
21323	Ø 230 mm	Ø 22,2 mm	1
21324	Ø 300 mm	Ø 25,4 mm	1
21327	Ø 350 mm	Ø 25,4 mm	1
21326	Ø 400 mm	Ø 25,4 mm	1

**FESTA**

## KOTOUČ DIAMANTOVÝ TURBO

Č.p.	specifikace		
21411	Ø 115 mm	Ø 22,2 mm	1
21412	Ø 125 mm	Ø 22,2 mm	1
21415	Ø 150 mm	Ø 22,2 mm	1
21418	Ø 180 mm	Ø 22,2 mm	1
21423	Ø 230 mm	Ø 22,2 mm	1
21424	Ø 300 mm	Ø 25,4 mm	1

**FESTA**

## KOTOUČ DIAMANTOVÝ PLNÝ

Č.p.	specifikace		
21210	Ø 110 mm	Ø 22,2 mm	1
21211	Ø 115 mm	Ø 22,2 mm	1
21212	Ø 125 mm	Ø 22,2 mm	1
21215	Ø 150 mm	Ø 22,2 mm	1
21218	Ø 180 mm	Ø 22,2 mm	1
21219	Ø 180 mm	Ø 25,4 mm	1
21220	Ø 200 mm	Ø 25,4 mm	1
21223	Ø 230 mm	Ø 22,2 mm	1
21224	Ø 300 mm	Ø 25,4 mm	1

**FESTA INDUSTRY**

## KOTOUČ ŘEZNÝ DIAMANTOVÝ UNIVERZÁLNÍ



Č.p.	specifikace		
21301	Ø 125 mm	Ø 22,2 mm	2,5 mm
21303	Ø 230 mm	Ø 22,2 mm	3 mm



**FESTA**

## KOTOUČ DIAMANTOVÝ SEGMENTOVÝ, DVOJITÝ

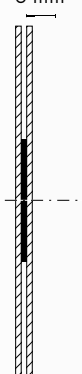

Č.p.	specifikace		
21195	Ø 125 x	Ø 22,2 mm	1

6 mm



## KOTOUČ DIAMANTOVÝ PLNÝ

Č.p.	specifikace		
21010	Ø 110 mm	Ø 22,2 mm	1
21011	Ø 115 mm	Ø 22,2 mm	1
21012	Ø 125 mm	Ø 22,2 mm	1
21015	Ø 150 mm	Ø 22,2 mm	1
21018	Ø 180 mm	Ø 22,2 mm	1
21023	Ø 230 mm	Ø 22,2 mm	1



## KOTOUČ DIAMANTOVÝ SEGMENTOVÝ

Č.p.	specifikace		
21110	Ø 110 mm	Ø 22,2 mm	1
21111	Ø 115 mm	Ø 22,2 mm	1
21112	Ø 125 mm	Ø 22,2 mm	1
21115	Ø 150 mm	Ø 22,2 mm	1
21118	Ø 180 mm	Ø 22,2 mm	1
21123	Ø 230 mm	Ø 22,2 mm	1



## KOTOUČ DIAMANTOVÝ TURBO

Č.p.	specifikace		
21130	Ø 110 mm	Ø 22,2 mm	1
21135	Ø 115 mm	Ø 22,2 mm	1
21140	Ø 125 mm	Ø 22,2 mm	1
21150	Ø 150 mm	Ø 22,2 mm	1
21180	Ø 180 mm	Ø 22,2 mm	1
21190	Ø 230 mm	Ø 22,2 mm	1





**FESTA**

KOTOUČ  
DIAMANTOVÝ  
BRUSNÝ



Č.p.	specifikace		
21435	Ø 115 mm	Ø 22,2 mm	1
21436	Ø 125 mm	Ø 22,2 mm	1
21437	Ø 150 mm	Ø 22,2 mm	1



**FESTA**

KOTOUČ  
DIAMANTOVÝ  
BRUSNÝ DVOURADÝ



Č.p.	specifikace		
21430	Ø 115 mm	Ø 22,2 mm	1
21431	Ø 125 mm	Ø 22,2 mm	1
21432	Ø 150 mm	Ø 22,2 mm	1



**FESTA**

KOTOUČ  
DIAMANTOVÝ  
BRUSNÝ TURBO



Č.p.	specifikace		
21425	Ø 100 mm	Ø 22,2 mm	1
21426	Ø 115 mm	Ø 22,2 mm	1
21427	Ø 125 mm	Ø 22,2 mm	1
21428	Ø 150 mm	Ø 22,2 mm	1



**FESTA**  
INDUSTRY

KOTOUČ  
ŘEZNÝ NA KOV



Č.p.	specifikace		
22258	Ø 115 mm	Ø 22,2 mm x 0,8 mm	25
22260	Ø 115 mm	Ø 22,2 mm x 1 mm	25
22263	Ø 115 mm	Ø 22,2 mm x 1,6 mm	25
22264	Ø 115 mm	Ø 22,2 mm x 2 mm	25
22259	Ø 125 mm	Ø 22,2 mm x 0,8 mm	25
22266	Ø 125 mm	Ø 22,2 mm x 1 mm	25
22269	Ø 125 mm	Ø 22,2 mm x 1,6 mm	25
22270	Ø 125 mm	Ø 22,2 mm x 2 mm	25
22273	Ø 150 mm	Ø 22,2 mm x 1,6 mm	25
22274	Ø 150 mm	Ø 22,2 mm x 2 mm	25
22275	Ø 150 mm	Ø 22,2 mm x 2,5 mm	25
22277	Ø 180 mm	Ø 22,2 mm x 2 mm	25
22280	Ø 230 mm	Ø 22,2 mm x 2 mm	25
22281	Ø 230 mm	Ø 22,2 mm x 2,5 mm	25



**FESTA**  
INDUSTRY

KOTOUČ  
ŘEZNÝ NA HLINÍK



Č.p.	specifikace		
22285	Ø 115 mm	Ø 22,2 mm x 1 mm	1
22286	Ø 125 mm	Ø 22,2 mm x 1 mm	1

**FESTA**  
INDUSTRY

KOTOUČ  
ŘEZNÝ NA KÁMEN



Č.p.	specifikace		
22294	Ø 230 mm	Ø 22,2 mm x 3 mm	1



**FESTA**

**KOTOUČ ŘEZNÝ NA KOV**



Č.p.	specifikace			
22211	Ø 115 mm	Ø 22,2 mm x 1 mm	INOX	50
22212	Ø 115 mm	Ø 22,2 mm x 1,2 mm	INOX	50
22225	Ø 125 mm	Ø 22,2 mm x 1 mm	INOX	50
22217	Ø 125 mm	Ø 22,2 mm x 1,2 mm	INOX	50

**FESTA**

**KOTOUČ ŘEZNÝ NA KOV**

**10x**



Č.p.	specifikace			
22228	Ø 115 mm	Ø 22,2 mm x 1 mm	INOX	1
22229	Ø 125 mm	Ø 22,2 mm x 1,2 mm	INOX	1

**FESTA**

**KOTOUČ ŘEZNÝ NA KOV**

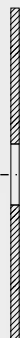

Č.p.	specifikace			
22251	Ø 115 mm	Ø 22,2 mm x 1,6 mm		50
22215	Ø 115 mm	Ø 22,2 mm x 2 mm		50
22216	Ø 115 mm	Ø 22,2 mm x 2,5 mm		50
22252	Ø 125 mm	Ø 22,2 mm x 1,6 mm		25
22218	Ø 125 mm	Ø 22,2 mm x 2,5 mm		25
22219	Ø 150 mm	Ø 22,2 mm x 1,2 mm		25
22253	Ø 150 mm	Ø 22,2 mm x 1,6 mm		50
22220	Ø 150 mm	Ø 22,2 mm x 2,5 mm		50
22254	Ø 180 mm	Ø 22,2 mm x 1,6 mm		50
22222	Ø 180 mm	Ø 22,2 mm x 2,5 mm		25
22255	Ø 230 mm	Ø 22,2 mm x 1,6 mm		25
22224	Ø 230 mm	Ø 22,2 mm x 2,5 mm		25

**FESTA**

**KOTOUČ BRUSNÝ NA KOV**



Č.p.	specifikace			
22240	Ø 115 mm	Ø 22,2 mm x 6,4 mm		25
22242	Ø 125 mm	Ø 22,2 mm x 6,4 mm		25
22244	Ø 150 mm	Ø 22,2 mm x 6,4 mm		25
22246	Ø 180 mm	Ø 22,2 mm x 6,4 mm		25
22248	Ø 230 mm	Ø 22,2 mm x 6,4 mm		25



**FESTA**

**KOTOUČ ŘEZNÝ NA KOV DIAMANTOVÝ**

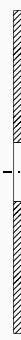

Č.p.	specifikace			
21306	Ø 125 mm	Ø 22,2 mm	1,3 mm	1
21308	Ø 230 mm	Ø 22,2 mm	1,8 mm	1

**FESTA**

**KOTOUČ ŘEZNÝ NA KÁMEN**

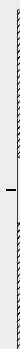

Č.p.	specifikace			
22230	Ø 115 mm	Ø 22,2 mm x 2,5 mm		50
22232	Ø 125 mm	Ø 22,2 mm x 2,5 mm		50
22234	Ø 150 mm	Ø 22,2 mm x 2,5 mm		25
22236	Ø 180 mm	Ø 22,2 mm x 2,5 mm		25
22238	Ø 230 mm	Ø 22,2 mm x 2,5 mm		25

**FESTA**

**KOTOUČ ŘEZNÝ UNIVERZÁLNÍ - KARBIDOVÝ**



Č.p.	specifikace			
21192	Ø 125 mm	Ø 22,2 mm		1
21194	Ø 230 mm	Ø 22,2 mm		1

**FESTA**  
KOTOUČ  
RAŠPLOVÝ



Č.p.	Specifikace			
21806	Ø 125 mm	Ø 22,2 mm		10



**FESTA**  
KOTOUČ  
RAŠPLOVÝ  
STŘEDNĚ HRUBÝ



Č.p.	specifikace			
21802	Ø 125 mm	Ø 22,2 mm	3 mm	10

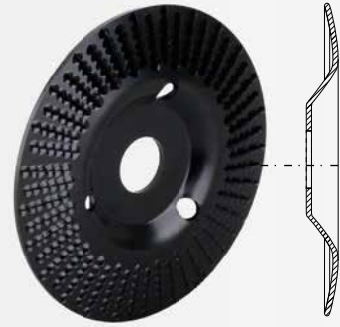

**FESTA**  
KOTOUČ  
RAŠPLOVÝ  
HRUBÝ



Č.p.	specifikace			
21801	Ø 125 mm	Ø 22,2 mm	3 mm	10

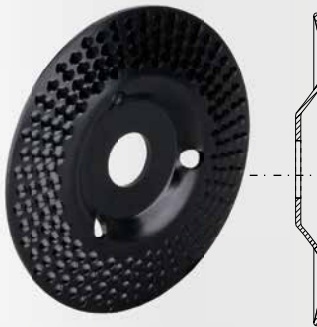

**FESTA**  
KOTOUČ  
RAŠPLOVÝ  
PILOVÝ



Č.p.	Specifikace			
21803	Ø 125 mm	Ø 22,2 mm	5 mm	1



**FESTA**  
KOTOUČ  
RAŠPLOVÝ  
PILOVÝ



Č.p.	Specifikace			
21805	Ø 125 mm	Ø 22,2 mm		1



**FESTA**  
KOTOUČ  
NA DŘEVO  
S OTVORY

· brusný kotouč vhodný pro broušení dřeva



Č.p.	specifikace			
21800	Ø 125 mm	Ø 22,2 mm		1

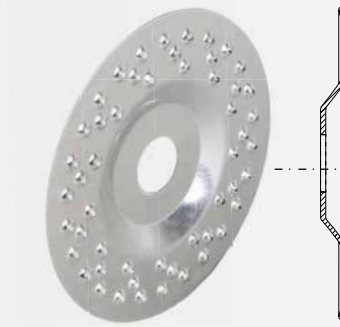

**FESTA**  
RAŠPLE VÁLCOVÁ



Č.p.	Specifikace			
21807	Ø 30 mm / 60 mm			1

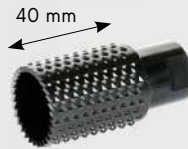

**FESTA**  
RAŠPLE KULOVÁ



Č.p.	Specifikace			
21808	Ø 30 mm / 105 mm			10



**FESTA**  
KOTOUČ  
ŘEZNÝ  
ŘETĚZOVÝ



Č.p.	Specifikace			
21804	Ø 125 mm	Ø 22,2 mm	14T	1

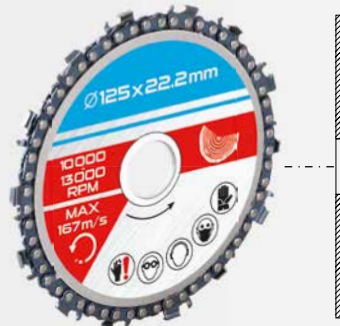

**NEW**

## KOTOUČ REZNÝ NA DŘEVO



Č.p.	Specifikace	1
21809	Ø 125 mm x 4T Ø 22,2 mm	1

**NEW**

**FESTA**

## KOTOUČ LAMELOVÝ OBOUSTRANNÝ



**INOX**



Č.p.	specifikace	hrubost	1
21760	Ø 125 mm Ø 22,2 mm	P40	10
21761	Ø 125 mm Ø 22,2 mm	P60	10
21762	Ø 125 mm Ø 22,2 mm	P80	10
21763	Ø 125 mm Ø 22,2 mm	P100	10
21764	Ø 125 mm Ø 22,2 mm	P120	10

**FESTA**

## KOTOUČ LAMELOVÝ

· brusný kotouč vhodný pro broušení nerez oceli



**INOX**

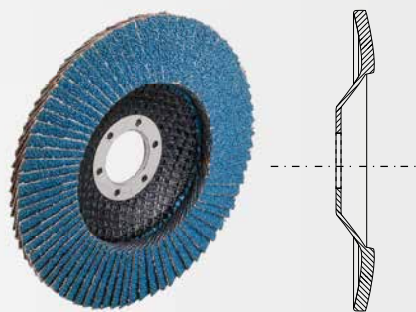

Č.p.	specifikace	hrubost	1
22140	Ø 115 mm Ø 22,2 mm	P40	5
22141	Ø 115 mm Ø 22,2 mm	P60	5
22142	Ø 115 mm Ø 22,2 mm	P80	5
22143	Ø 115 mm Ø 22,2 mm	P100	5
22145	Ø 125 mm Ø 22,2 mm	P40	5
22146	Ø 125 mm Ø 22,2 mm	P60	5
22147	Ø 125 mm Ø 22,2 mm	P80	5
22148	Ø 125 mm Ø 22,2 mm	P100	5
22150	Ø 150 mm Ø 22,2 mm	P40	5
22151	Ø 150 mm Ø 22,2 mm	P60	5
22155	Ø 150 mm Ø 22,2 mm	P80	5
22156	Ø 150 mm Ø 22,2 mm	P100	5

**NEW**

**FESTA INDUSTRY**

## KOTOUČ LAMELOVÝ - DIAMANTOVÝ

- pro zábрус dlažeb
- keramické obklady a dlažba
- mramor
- žula



· použití bez chlazení vodou

Č.p.	Specifikace	1
24647	Ø 115 mm Ø 22,2 mm P60	1
24648	Ø 115 mm Ø 22,2 mm P120	1
24649	Ø 115 mm Ø 22,2 mm P200	1

## KOTOUČ LAMELOVÝ



Č.p.	specifikace	hrubost	1
21780	Ø 115 mm Ø 22,2 mm	P40	10
21781	Ø 115 mm Ø 22,2 mm	P60	10
21782	Ø 115 mm Ø 22,2 m	P80	10
21783	Ø 115 mm Ø 22,2 mm	P100	10
21784	Ø 115 mm Ø 22,2 mm	P120	10
21786	Ø 125 mm Ø 22,2 mm	P40	10
21787	Ø 125 mm Ø 22,2 mm	P60	10
21788	Ø 125 mm Ø 22,2 mm	P80	10
21789	Ø 125 mm Ø 22,2 mm	P100	10
21790	Ø 125 mm Ø 22,2 mm	P120	10
21792	Ø 150 mm Ø 22,2 mm	P40	10
21793	Ø 150 mm Ø 22,2 mm	P60	10
21794	Ø 150 mm Ø 22,2 mm	P80	10
21795	Ø 150 mm Ø 22,2 mm	P100	10
21796	Ø 150 mm Ø 22,2 mm	P120	10

## KOTOUČ BRUSNÝ UNIVERZÁLNÍ



Č.p.	specifikace	1
21798	Ø 125 mm Ø 22,2 mm	1



# FESTA



**FESTA**  
KARTÁČ MISKOVÝ, VLNITÝ

· pomosazený

Č.p.	specifikace	drát	
21900	Ø 100 mm M14	s 0,3	60
21902	Ø 125 mm M14	s 0,3	42



**FESTA**  
KARTÁČ MISKOVÝ, VLNITÝ

· pomosazený

Č.p.	specifikace	drát	
22001	Ø 100 mm M14	s 0,3	60
21901	Ø 125 mm M14	s 0,3	42



**FESTA**  
KARTÁČ MISKOVÝ, VLNITÝ

· mosazný

Č.p.	specifikace	drát	
21920	Ø 100 mm M14	s 0,3	60



**FESTA**  
KARTÁČ HRNKOVÝ, VLNITÝ

· pomosazený

Č.p.	specifikace	drát	
21903	Ø 65 mm M14	s 0,3	60
22002	Ø 75 mm M14	s 0,3	80
21904	Ø 85 mm M14	s 0,3	60
22003	Ø 100 mm M14	s 0,3	36
21905	Ø 125 mm M14	s 0,3	24
21906	Ø 150 mm M14	s 0,3	12



**FESTA**  
KARTÁČ HRNKOVÝ, VLNITÝ

· mosazný

Č.p.	specifikace	drát	
21925	Ø 75 mm M14	0,3 mm	80
21926	Ø 100 mm M14	0,3 mm	36



**FESTA**  
KARTÁČ OKRUŽNÍ, VLNITÝ

· pomosazený  
· redukční kroužky

Č.p.	specifikace	drát	
22007	Ø 100 mm Ø 20 mm	s 0,3	60
22008	Ø 125 mm Ø 20 mm	s 0,3	42
22009	Ø 150 mm Ø 32,2 mm	s 0,3	32
22010	Ø 175 mm Ø 32,2 mm	s 0,3	20
22011	Ø 200 mm Ø 32,2 mm	s 0,3	20



**FESTA**  
KARTÁČ HRNKOVÝ, COPY

· patentované

Č.p.	specifikace	drát	
22037	Ø 65 mm M14	s 0,5	60
22038	Ø 80 mm M14	s 0,5	24



**FESTA**  
KARTÁČ HRNKOVÝ, COPY

· patentované

Č.p.	specifikace	drát	
22004	Ø 65 mm M14	s 0,3	60
22005	Ø 75 mm M14	s 0,3	24
22006	Ø 100 mm M14	s 0,3	24
21907	Ø 125 mm M14	s 0,5	24
21908	Ø 150 mm M14	s 0,3	12



**FESTA**  
KARTÁČ RADIÁLNÍ, COPY

· patentované

Č.p.	specifikace	drát	počet copů	
21911	Ø 100 mm M14	s 0,5	30	60
21912	Ø 115 mm M14	s 0,5	32	42
21913	Ø 125 mm M14	s 0,5	36	42
21914	Ø 150 mm M14	s 0,5	40	32



**FESTA**

**KARTÁČ RADIÁLNÍ, COPY**

· patentované

**M14**



Č.p.	specifikace	drát	
22012	Ø 100 mm M14	s 0,5	60
22013	Ø 115 mm M14	s 0,5	42
22014	Ø 125 mm M14	s 0,5	42
22015	Ø 150 mm M14	s 0,5	32
22016	Ø 178 mm M14	s 0,5	20



**FESTA**

**KARTÁČ RADIÁLNÍ, COPY**

· patentované

**INOX M14**



Č.p.	specifikace	drát	
22039	Ø 100 mm M14	s 0,5	60
22040	Ø 125 mm M14	s 0,5	42



**FESTA**

**KARTÁČ MISKOVÝ, COPY**

· patentované

**M14**



Č.p.	specifikace	drát	
22017	Ø 100 mm M14	s 0,5	60
21909	Ø 115 mm M14	s 0,5	42
21910	Ø 125 mm M14	s 0,5	42



**FESTA**

**KARTÁČ OKRUŽNÍ, COPY, STOPKA**

· patentované



Č.p.	specifikace	drát	
22023	Ø 75 mm	s 0,5	10



**FESTA**

**KARTÁČ HRNKOVÝ, COPY, STOPKA**

· patentované



Č.p.	specifikace	drát	
22024	Ø 75 mm	s 0,5	12



**FESTA**

**KARTÁČ MISKOVÝ, COPY, STOPKA**

· patentované



Č.p.	specifikace	drát	
22025	Ø 75 mm	s 0,5	12

**NEW**



**FESTA**

**KARTÁČ OKRUŽNÍ, COPY**



Č.p.	Specifikace	
21950	Ø 200 mm 25,4 mm	1



**FESTA**

**KARTÁČ HRNKOVÝ, VLNITÝ, POMOSAZENÝ**

· pomosazený



Č.p.	specifikace	drát	
22030	Ø 65 mm	s 0,3	12
22031	Ø 75 mm	s 0,3	12



**FESTA**

**KARTÁČ OKRUŽNÍ, VLNITÝ, POMOSAZENÝ**

· pomosazený



Č.p.	specifikace	drát	
22026	Ø 50 mm	s 0,3	15
22027	Ø 63 mm	s 0,3	15
22028	Ø 75 mm	s 0,3	10
22029	Ø 100 mm	s 0,3	15



**FESTA**

**KARTÁČ KONCOVÝ, VLNITÝ STOPKA**



Č.p.	specifikace	drát	
22058	Ø 12 mm	s 0,3	25
22059	Ø 25 mm	s 0,3	25



**FESTA**

**KARTÁČ KONCOVÝ, VLNITÝ POMOSAZENÝ**

· pomosazený



Č.p.	specifikace	drát	
22018	Ø 12 mm	s 0,3	15
22019	Ø 17 mm	s 0,3	15
22020	Ø 25 mm	s 0,3	25



**FESTA**

**KARTÁČ KONCOVÝ, COPY, STOPKA**

· patentované



Č.p.	specifikace	drát	
22021	Ø 19 mm	s 0,5	30
22022	Ø 22 mm	s 0,5	25



**FESTA**

KARTÁČ HRNKOVÝ, VLNITÝ, NYLONOVÝ



Č.p.	specifikace	drát	
21940	Ø 75 mm M14	1,2 mm	1
21941	Ø 100 mm M14	1,2 mm	1



**FESTA**

KARTÁČ OKRUŽNÍ, NYLONOVÝ



Č.p.	specifikace	drát	
21930	Ø 125 mm M14	1,2 mm	10
21931	Ø 150 mm M14	1,2 mm	15

Ø 6 mm



**FESTA**

KARTÁČ OKRUŽNÍ, NYLONOVÝ, STOPKA



Č.p.	specifikace	drát	
22032	Ø 100 mm	1,2 mm	12

Ø 6 mm

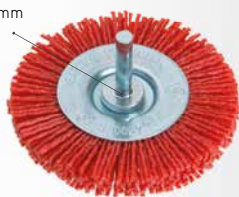

**FESTA**

KARTÁČ OKRUŽNÍ, NYLONOVÝ, STOPKA



Č.p.	specifikace	drát	
21935	Ø 50 mm	1,2 mm	15
21936	Ø 75 mm	1,2 mm	10
21937	Ø 100 mm	1,2 mm	15



Ø 6 mm

KOTOUČ NYLONOVÝ, STOPKA



Č.p.	specifikace	
22088	Ø 65 mm	9
22090	Ø 100 mm	5



KARTÁČ NYLON



Č.p.	specifikace	
22083	Ø 115 mm Ø 22,2 mm	10
22084	Ø 125 mm Ø 22,2 mm	10
22085	Ø 150 mm Ø 22,2 mm	10



KOTOUČ NYLONOVÝ



Č.p.	specifikace	
22095	Ø 178 mm	1

**NEW**

**FESTA**

KOTOUČ BRUSNÝ DIAMANTOVÝ SE SUCHÝM ZIPEM

- keramické obklady
- sklo
- mramor
- žula



• unášec 22043

Č.p.	specifikace	hrubost	
24665	Ø 100 mm	● P60	10
24666	Ø 100 mm	● P120	10
24667	Ø 100 mm	● P200	10

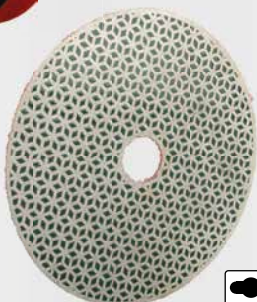

**FESTA**

KOTOUČ DIAMANTOVÝ LEŠTICÍ Ø 100 MM, SE SUCHÝM ZIPEM

- keramické obklady
- sklo
- mramor
- žula



• unášec 22043

Č.p.	hrubost	
22701	50	1
22702	100	1
22703	200	1
22704	400	1
22705	800	1
22706	1500	1
22707	3000	1



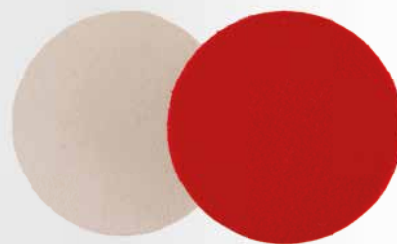

## KOTOUČ LEŠTÍCÍ, BERÁNEK



Č.p.	specifikace	specifikace	
22065	Ø 125 mm	se suchým zipem	20
22066	Ø 150 mm	se suchým zipem	20

## FILC LEŠTÍCÍ SE SUCHÝM ZIPEM



Č.p.	specifikace	
22070	Ø 115 mm	20
22071	Ø 125 mm se suchým zipem	20
22072	Ø 150 mm	20

## FESTA

### UNAŠEČ BRUSNÉHO PAPIŘU SE SUCHÝM ZIPEM

- M14 | Ø 8 mm
- EVA 10 mm

M14



Č.p.	specifikace	
22062	Ø 115 mm	25
22063	Ø 125 mm	25
22064	Ø 150 mm	10

## FESTA

### UNAŠEČ PRO FIBROVÝ KOTOUČ



M14



Č.p.	specifikace	
22073	Ø 125 mm, M14	1
22074	Ø 150 mm, M14	1



## FESTA

### UNAŠEČ DIAMANTOVÝCH LEŠTÍCÍCH KOTOUČŮ

- pro úhlovou brusku
- pro 24665-24667, 22701-22707

M14



Č.p.	specifikace	
22043	Ø 100 mm se suchým zipem	1



### UNAŠEČ BRUSNÉHO PAPIŘU

- pro úhlovou brusku

M14



Č.p.	specifikace	
22044	Ø 125 mm M14 se suchým zipem	15
22060	Ø 150 mm M14 se suchým zipem	6



8 mm



Ø 8 mm

### UNAŠEČ BRUSNÉHO PAPIŘU - KLOUBOVÝ



Č.p.	specifikace	
22061	Ø 125 mm se suchým zipem	6



### UNAŠEČ BRUSNÉHO PAPIŘU



Č.p.	specifikace	
22041	Ø 125 mm upínání šroubem	11
22042	Ø 125 mm se suchým zipem	11

## ADAPTÉR

M14



Č.p.	specifikace	
22087		1



Ø 6 mm

## KOTOUČ NYLONOVÝ, BRUSNÝ



Č.p.	specifikace	
22091	Ø 50 mm P240	1
22092	Ø 75 mm P240	1
22093	Ø 100 mm P240	1

## FESTA

### KOTOUČ FIBROVÝ - Ø 125 MM

3x



Č.p.	hrubost	
22160	P40	1
22161	P60	1
22162	P80	1
22163	P100	1
22164	P120	1



## FESTA

### KOTOUČ FIBROVÝ - Ø 150 MM

3x



Č.p.	hrubost	
22167	P80	1



**FESTA**

PAPÍR BRUSNÝ Ø 125 MM, SE SUCHÝM ZIPEM

3x

Č.p.	hrubost	
22045	P40	1
22046	P60	1
22047	P80	1
22048	P100	1
22049	P120	1
22050	P150	1
22051	P180	1
22052	P220	1

**FESTA**

PAPÍR BRUSNÝ Ø 150 MM, SE SUCHÝM ZIPEM

3x

Č.p.	hrubost	
22053	P40	1
22054	P60	1
22055	P80	1
22056	P100	1
22057	P120	1

**FESTA**VIBRAČNÍ VÝSEK  
94 X 94 X 94 MM

Č.p.	hrubost	
21831	P60	1
21832	P80	1
21834	P120	1

PAPÍR BRUSNÝ SE SUCHÝM  
ZIPEM - 125 MM

3x

Č.p.	hrubost	
22096	P40	20
22097	P60	20
22098	P80	20
22099	P120	20

**FESTA**NEKONEČNÝ BRUSNÝ PÁS  
75 X 533 MM

3x

Č.p.	hrubost	
21810	P40	20
21811	P60	20
21812	P80	20
21813	P100	20
21814	P120	20



PAPÍR BRUSNÝ 93 X 230 MM

5x

Č.p.	hrubost	počet otvorů	
21740	P40	8	20
21741	P60	8	20
21742	P80	8	20
21743	P100	8	20
21744	P120	8	20



PAPÍR BRUSNÝ 115 X 280 MM

5x

Č.p.	hrubost	počet otvorů	
21750	P40	10	20
21751	P60	10	20
21752	P80	10	20
21753	P100	10	20
21754	P120	10	20

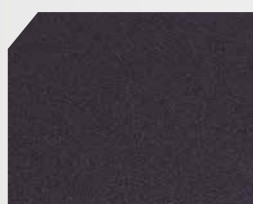
PLÁTNO BRUSNÉ  
230 X 280 MM

10x

Č.p.	hrubost	
21732	P40	1
21734	P60	1
21735	P80	1
21736	P100	1
21737	P120	1

PAPÍR BRUSNÝ VODĚODOLNÝ  
230 X 280 MM

10x

Č.p.	hrubost	
21701	P60	1
21702	P80	1
21703	P100	1
21704	P120	1
21705	P150	1
21706	P180	1
21709	P240	1

PAPÍR BRUSNÝ  
230 X 280 MM

10x

Č.p.	hrubost	
21715	P40	1
21716	P60	1
21717	P80	1
21718	P100	1
21719	P120	1
21720	P150	1
21721	P180	1
21724	P240	1

**NEW**



**FESTA**

## DRŽÁK BRUSNÉHO PAPIŘU

· Ø 150 mm



Č.p.	specifikace	
22119		1

**FESTA**

## DRŽÁK BRUSNÉHO PAPIŘU

· rychloupínací  
· buková rukojeť



Č.p.	specifikace	
22067	170 x 70 mm	10

## DRŽÁK BRUSNÉHO PAPIŘU



Č.p.	specifikace	
22075	210 x 105 mm	100
22076	160 x 85 mm	100

## DRŽÁK BRUSNÉHO PAPIŘU



Č.p.	specifikace	
22077	125 x 68 mm	10

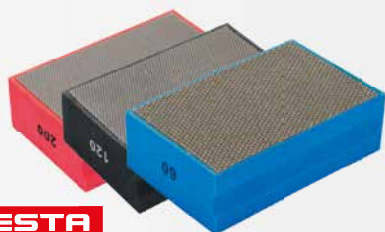

**FESTA**

## HOUBA DIAMANTOVÁ BRUSNÁ

· 90 x 55 x 25 mm  
· keramické obklady  
· sklo  
· mramor  
· žula



Č.p.	hrubost	
22115	P60	10
22116	P120	10
22117	P200	10

## BRUSNÝ LAMELOVÝ KOTOUČ NA STOPCE

Č.p.	hrubost	specifikace	
21850	P40		1
21851	P60		1
21852	P80	20 x 20, Ø 6 mm	1
21853	P100		1
21854	P120		1
21855	P40		1
21856	P60		1
21857	P80	30x30, Ø 6mm	1
21858	P100		1
21859	P120		1
21860	P40		1
21861	P60		1
21862	P80	60x30, Ø 6mm	1
21863	P100		1
21864	P120		1

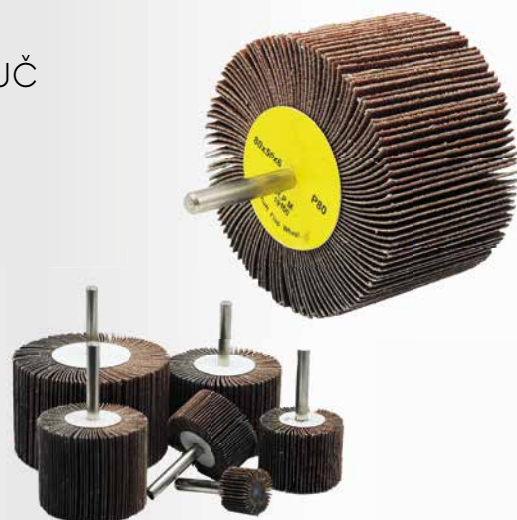

**FESTA**

## HOUBA BRUSNÁ 100 X 70 X 28 MM - ZKOSENÁ



Č.p.	hrubost	
22106	P 60	10
22107	P 80	10
22108	P 100	10
22109	P 120	10



**FESTA**

## HOUBA BRUSNÁ 100 X 70 X 25 MM



Č.p.	hrubost	
22100	P60	20
22101	P80	20
22102	P100	20
22103	P120	20
22104	P180	20
22105	P220	20



**FESTA**

## HOUBA BRUSNÁ 120 X 95 X 10 MM



Č.p.	hrubost	
22110	P80	20
22111	P120	20
22112	P180	20
22113	P220	20



**FESTA**

Č.p.	specifikace	počet zubů	
<b>Ø 115 mm</b>			
22300	Ø 115 x 22 mm	40	1
<b>Ø 125 mm</b>			
22301	Ø 125 x 22 mm	40	1
<b>Ø 140 mm</b>			
22302	Ø 140 x 20 mm	24	1
22303	Ø 140 x 20 mm	30	1
<b>Ø 150 mm</b>			
22305	Ø 150 x 20 mm	24	1
<b>Ø 160 mm</b>			
22307	Ø 160 x 20 mm	18	1
22309	Ø 160 x 20 mm	24	1
22310	Ø 160 x 20 mm	30	1
22311	Ø 160 x 20 mm	36	1
22312	Ø 160 x 20 mm	48	1
22313	Ø 160 x 20 mm	60	1
<b>Ø 165 mm</b>			
22314	Ø 165 x 20 mm	24	1
<b>Ø 180 mm</b>			
22315	Ø 180 x 30 mm	24	1
22317	Ø 180 x 30 mm	50	1
22318	Ø 180 x 20 mm	50	1
<b>Ø 185 mm</b>			
22316	Ø 185 x 20 mm	24	1
<b>Ø 190 mm</b>			
22319	Ø 190 x 20 mm	40	1
22320	Ø 190 x 30 mm	40	1
<b>Ø 200 mm</b>			
22322	Ø 200 x 30 mm	24	1
22324	Ø 200 x 30 mm	40	1
22326	Ø 200 x 30 mm	60	1
<b>Ø 205 mm</b>			
22328	Ø 205 x 30 mm	40	1
22329	Ø 205 x 30 mm	60	1
<b>Ø 210 mm</b>			
22332	Ø 210 x 30 mm	40	1
22333	Ø 210 x 30 mm	60	1
<b>Ø 250 mm</b>			
22335	Ø 250 x 30 mm	40	1
22337	Ø 250 x 30 mm	60	1
<b>Ø 300 mm</b>			
22340	Ø 300 x 30 mm	40	1
22343	Ø 300 x 30 mm	60	1
22345	Ø 300 x 30 mm	96	1
<b>Ø 350 mm</b>			
22350	Ø 350 x 30 mm	40	1
22351	Ø 350 x 30 mm	54	1
<b>Ø 400 mm</b>			
22355	Ø 400 x 30 mm	40	1
22357	Ø 400 x 30 mm	60	1
<b>Ø 500 mm</b>			
22365	Ø 500 x 30 mm	60	1
<b>Ø 600 mm</b>			
22370	Ø 600 x 30 mm	60	1

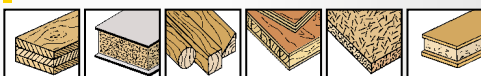
**FESTA****KOTOUČ PILOVÝ DO DŘEVA S SK PLÁTKY****REDUKČNÍ KROUŽEK**

Č.p.	specifikace	
22399	Ø 20   16 mm	1
22398	Ø 30   25 mm	1

**FESTA**

SADA NÁSTROJŮ PRO OSCILAČNÍ BRUSKU

pro 28045

**FESTA**  
POWER X TOOLS



4x

3x BI-METAL



1x SK5

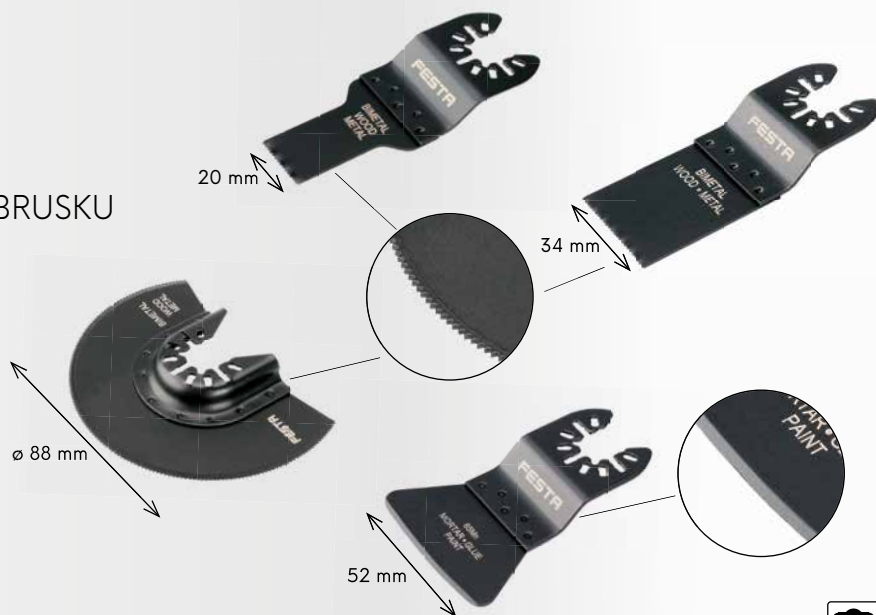

Č.p. Specifikace

24322

6

**FESTA**

SADA NÁSTROJŮ PRO OSCILAČNÍ BRUSKU

pro 28045

**FESTA**  
POWER X TOOLS



4x

3x CARBIDE



1x

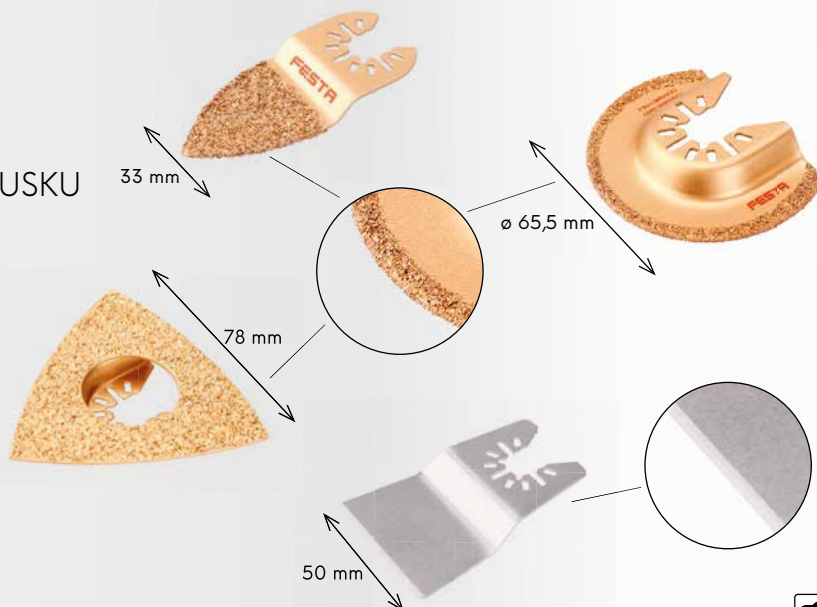

Č.p. Specifikace

24321

6

SADA NÁSTROJŮ PRO OSCILAČNÍ BRUSKU

pro 28045

**FESTA**  
POWER X TOOLS



HCS 3x

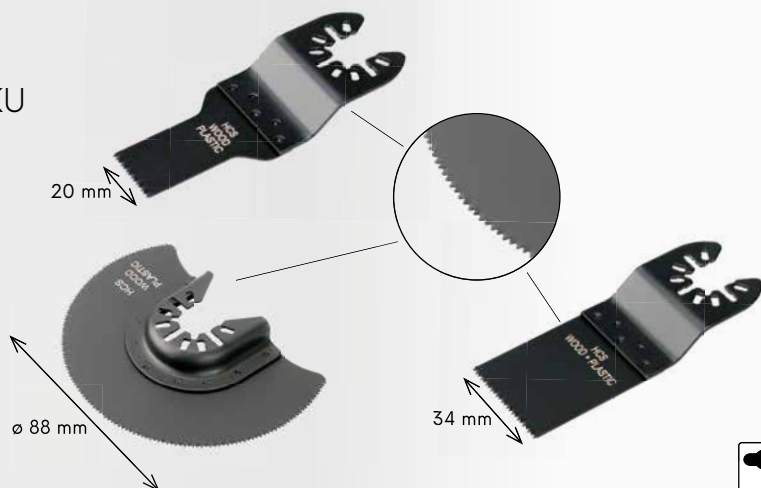

Č.p. Specifikace

24320

6

PROFESIONÁLNÍ PŘÍMOČARÉ PILKY  
VYROBENO V NĚMECKU TECHNOLOGIÍ VYPALOVÁNÍM LASEREM



PILKA PŘÍMOČARÁ HSS - UCHYCENÍ AEG, BOSCH, FESTO, MAKITA, METABO

	24060	50mm/1mm	0,7 mm/ 36TPI	31007	5 ks	10	
	24061	50mm/1mm	1,2 mm/ 21TPI	31012	5 ks	10	
	24062	50mm/1mm	2,0 mm/ 13TPI	31020	5 ks	10	
	24063	75mm/1mm	3,0 mm/ 8TPI	31030	5 ks	10	
	24064	100mm/1mm	1,2 mm/ 21TPI	31112	5 ks	10	
	24065	100mm/1,3mm	2,0 mm/ 13TPI	31112	5 ks	10	
	24066	75mm/1,45mm	2,0 mm/ 13TPI	31220	5 ks	10	
	24067	120mm/1,3mm	1,8 - 2,4 mm/ 10 - 14 TPI	31220	5 ks	10	
	24068	75mm/1,45mm	2,5 mm/ 10 TPI	32225	5 ks	10	
	24069	75mm/1,45mm	4 mm/ 6 TPI	32240	5 ks	10	
	24070	75mm/1,3mm	4 mm/ 6 TPI	32340	5 ks	10	
	24071	75mm/1,3mm	4 mm/ 6 TPI	32440	5 ks	10	
	24072	75mm/1,45mm	2,5 mm/ 10 TPI	32625	5 ks	10	
	24073	85mm/1,45mm	3 mm/ 8 TPI	32730	5 ks	10	
	24074	85mm/1,45mm	4 mm/ 6 TPI	32730	5 ks	10	
	24075	75mm/1,45mm	2,5   1,2 mm/10   21 TPI	32825	5 ks	10	
	24076	75mm/1,7mm	4 mm   6 TPI	32940	5 ks	10	
	24077	120mm/1,3mm	4 mm   6 TPI	32040	5 ks	10	
	24078	105mm/1,45mm	4 mm   6 TPI	34040	5 ks	10	
	24055	55mm	karbidová		5 ks	1	

## PIŁKA PŘÍMOČARÁ HSS - UCHYCENÍ BLACK & DECKER, FERM

	24080	50mm   1,0 mm	1,2   21 TPI	11012	5 ks	10	
	24081	75mm   1,0 mm	3,0   8 TPI	11030	5 ks	10	
	24082	75mm   1,45 mm	2,5   10 TPI	12225	5 ks	10	
	24083	75mm   1,45 mm	4   6 TPI	12240	5 ks	10	
	24084	75mm   1,3 mm	4   6 TPI	12340	5 ks	10	
	24085	50mm   1,0 mm	2,0   13 TPI	12420	5 ks	10	
	24086	75mm   1,3 mm	4,0   6 TP	12440	5 ks	10	
	24087	75mm   1,45 mm	2,5   10 TPI	12625	5 ks	10	

	měkká ocel (s malým obsahem uhlíku)		ocelový plech		nerozavějící ocel		laminovaná prkna
	neželezné kovy		tvrdé a měkké dřevo		dřevotříská		plasty
	překlížka		laťová překlížka		dřevo s hřebíky		
	sendvičový materiál		dlažba a obklady		hliník		

## STOJAN PŘÍMOČARÝCH PILEK

- osazení stojanu 24098 - 24060 · 5 ks
- 24080 · 5 ks
- 24061 · 5 ks
- 24062 · 5 ks
- 24081 · 5 ks
- 24063 · 5 ks
- 24066 · 5 ks
- 24067 · 5 ks
- 24082 · 5 ks
- 24068 · 5 ks
- 24083 · 5 ks
- 24069 · 5 ks
- 24084 · 5 ks
- 24070 · 5 ks
- 24086 · 5 ks
- 24071 · 5 ks
- 24087 · 5 ks
- 24072 · 5 ks
- 24073 · 5 ks
- 24074 · 5 ks
- 24075 · 5 ks
- 24076 · 5 ks



## SADA PŘÍMOČARÝCH PILEK



5x

Č.p.	specifikace	
24045	sada	50

Č.p.	specifikace	
24099	64 x 50 cm - prázdný	1
24098	64 x 50 cm - osazený	1

**FESTA**

## PILOVÝ PLÁTEK



Č.p. specifikace  
24301 150 x 19 x 1,3 mm TPI 6



1

**FESTA**

## PILOVÝ PLÁTEK

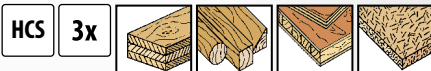

Č.p. specifikace  
24302 225 x 19 x 1,3 mm TPI 3



1

**FESTA**

## PILOVÝ PLÁTEK



Č.p. specifikace  
24303 200 x 19 x 1,3 mm TPI 6 - 10

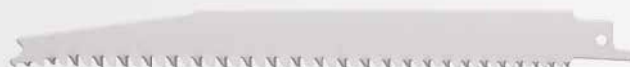

1

**FESTA**

## PILOVÝ PLÁTEK



Č.p. specifikace  
24304 240 x 19 x 1,5 mm TPI 5



1

**FESTA**

## PILOVÝ PLÁTEK

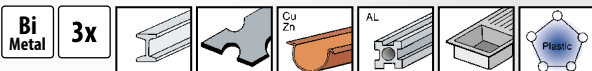

Č.p. specifikace  
24305 150 x 19 x 1 mm TPI 24

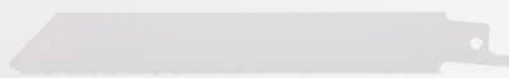

1

**FESTA**

## PILOVÝ PLÁTEK

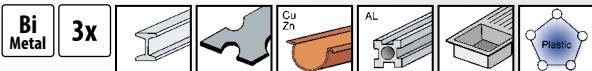

Č.p. specifikace  
24306 150 x 19 x 1 mm TPI 9



1

**FESTA**

## PILOVÝ PLÁTEK



Č.p. specifikace  
24308 225 x 19 x 1 mm TPI 10 - 14

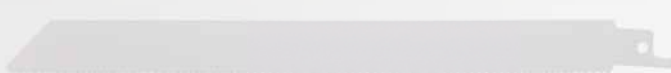

1

**FESTA**

## PILOVÝ PLÁTEK



Č.p. specifikace  
24310 150 x 22 x 1,6 mm TPI 9



1

**FESTA**

## PILOVÝ PLÁTEK



Č.p.	specifikace	
24313	225 x 22 x 1,6 mm TPI 6	1

**FESTA**

## PILA NA KOV HSS

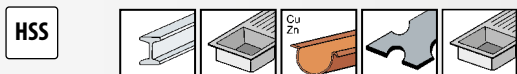

Č.p.	specifikace	
24050	203 x 19 x 1 mm TPI 10 - 14	25

**FESTA**

## PILOVÝ PLÁTEK

· SK zuby, dlouhá životnost

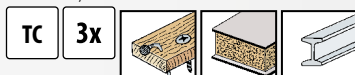

Č.p.	specifikace	
24312	225 x 19 x 1,3 mm TPI 6 - 9	1

**FESTA**

## PILOVÝ PLÁTEK

**SK**

 · porobeton  
 · porotherm  
 · cihly

Č.p.	specifikace	
24315	305 x 50 x 1,5 mm	1
24316	455 x 50 x 1,5 mm	25

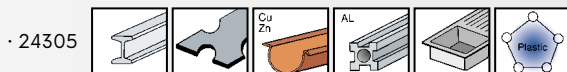
**FESTA**

## SADA PILOVÝCH PLÁTKŮ

**Bi Metal HCS 3x**

Č.p.	specifikace	
24314		1

**FESTA**

## RUKOJEŤ PRO PILOVÉ PLÁTKY

 · rukojeť + 2x pilový plátek  
 · pro pilové plátky do pily ocasky

Č.p.	specifikace	
24325		1





**FESTA**  
**INDUSTRY**



## PILOVÝ PLÁTEK

· kalené zuby



Č.p.	specifikace	
24185	533 mm	1
24186	610 mm	1
24187	760 mm	1
24188	800 mm	1
24189	914 mm	1

## FESTA

### PILOVÝ PLÁTEK

· kalené zuby



Č.p.	specifikace	
24169	350 mm	10
24167	450 mm	10
24166	533 mm	10
24163	610 mm	10
24164	760 mm	10
24168	800 mm	10
24165	914 mm	10



## PILOVÝ PLÁTEK



Č.p.	specifikace	
24195	rozteč 3 mm   300 mm	1
24196	rozteč 4 mm   300 mm šikmý zub	1
24197	rozteč 5 mm   300 mm kalený zub	1
24192	pilový list do řeznické pily 450 mm	1

### PILOVÝ PLÁTEK

Č.p.	specifikace	
24160	rozteč 3 mm   300 mm	20
24161	rozteč 4 mm   300 mm	20
24162	rozteč 5 mm   300 mm	50



## PILOVÝ PLÁTEK

10x



Č.p.	specifikace	
24108	6 mm   150 mm	1

## ŘEZACÍ STRUNA



Č.p.	specifikace	
24120	300 mm	50



## FESTA

### PILOVÝ PLÁTEK BI - METAL

· 8 % COBALT



Č.p.	specifikace	
24180	300 mm	125

## FESTA

### PILOVÝ PLÁTEK



Č.p.	specifikace	
24109	12,5 mm   300 mm na kov	144
24118	25 mm   300 mm na kov oboustranný	72
24119	25 mm   300 mm na kov a dřevo	72

MOQ





96

SVINOVACÍ METRY



101

SKLÁDACÍ METRY



104

PRAVÍTKA A ÚHELNÍKY



106

VODOVÁHY A LATĚ



112

LASEROVÁ MĚŘIDLA



116

TUŽKY A ZNAČKOVAČE



120

SPREJE



122

ODLAMOVCÍ NOŽE



137

SVÁŘEČKY, ŘEZAČE,  
KLEŠTĚ NA PVC TRÚBKY

140

ŠROUBOVÁKY



146

BITY



154

GOLA SADY A RÁČNY



159

HLAVICE, NÁSTAVCE,  
ADAPTÉRY

164

KLÍČE



169

KLEŠTĚ



179

NŮŽKY NA PLECH, NŮŽKY  
TECHNICKÉ

182

KLEŠTĚ NÝTOVACÍ



188

PILNÍKY A RAŠPLE



190

PILY NA DŘEVO, KOV A JINÉ



195

KLADIVA, PALICE



203

SVĚRKY

DÍLENSKÉ NÁŘADÍ

94 - 205



# KOMELON®

· VYSOCE PŘESNÁ A KVALITNÍ MĚŘIDLA

- II. třída přesnosti dle ČSN 251104, EEC 755345
- nylonový povrch pásku DURA NY Coat™ zaručuje desetinasobně vyšší odolnost proti otěru stupnice



· Otěruvzdorná vrstva nylonu DURA NY Coat™

## KOMELON® METR SVINOVACÍ



Č.p.	specifikace	
10002	2 m · 16 mm	10
10003	3 m · 16 mm	10
10005	5 m · 19 mm	10
10008	8 m · 25 mm	10



· Otěruvzdorná vrstva nylonu DURA NY Coat™

## KOMELON® METR SVINOVACÍ



Č.p.	specifikace	
10025	5 m · 25 mm	10



· Otěruvzdorná vrstva nylonu DURA NY Coat™

## KOMELON® METR SVINOVACÍ

- automatická brzda
- protiskluzové pogumování



Č.p.	specifikace	
10033	3 m · 16 mm	6
10035	5 m · 19 mm	6



## KOMELON® METR SVINOVACÍ



Č.p.	specifikace	
10043	3 m · 16 mm	30
10045	5 m · 19 mm	30
10048	8 m · 25 mm	12



## KOMELON® PÁSMO OCELOVÉ

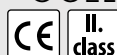

Č.p.	specifikace	
10110	10 m · 10 mm	6
10120	20 m · 10 mm	6
10130	30 m · 10 mm	6



## KOMELON® PÁSMO SKLOLAMINÁTOVÉ



Č.p.	specifikace	
10330	10 m · 13 mm	6
10332	20 m · 13 mm	6
10334	30 m · 13 mm	6
10336	50 m · 13 mm	6



**KOMELON®**

**PÁSMO  
SKLOLAMINÁTOVÉ**



Č.p.	specifikace	
10430	30 m · 13 mm	1
10450	50 m · 13 mm	1
10490	100 m · 13 mm	1



· ilustrační foto

## STOJAN NA METRY

Č.p.	specifikace	
10998		1

**KOMELON®**

## STOJAN NA METRY

· osazení stojanu 10996

10003 ·	5 ks
10005 ·	4 ks
10008 ·	1 ks
10033 ·	2 ks
10035 ·	3 ks
10045 ·	2 ks
10025 ·	3 ks
10110 ·	1 ks
10120 ·	1 ks
10130 ·	1 ks
10430 ·	1 ks
10330 ·	1 ks
10332 ·	1 ks
10334 ·	1 ks
10336 ·	1 ks



· ilustrační foto

Č.p.	specifikace	
10999	stojan na metry	1
10996	stojan na metry osazený	1



· Informace o pásce metru



· délka metru



· třída přesnosti



· prohlášení o shodě - CE



· rok výroby



· číslo akreditované zkušební vydávající certifikát



· výrobce



· speciální úprava pásky



· teplota, při které byla zkouška prováděna

FESTA



## FESTA

## METR SVINOVACÍ

- stupnice s velkými číslicemi
- protiskuzové pogumování
- nylonová vrstva



Č.p.	specifikace	
11353	3 m · 19 mm	12
11355	5 m · 19 mm	12
11356	5 m · 25 mm	12
11358	8 m · 25 mm	6
11360	10 m · 25 mm	6



## FESTA

## METR SVINOVACÍ

- nylonová vrstva
- ABS pouzdro
- pochromovaný, kovový klip
- automatická brzda
- protiskuzové pogumování PTE
- poutko



Č.p.	specifikace	
11343	3 m · 16 mm	6
11345	5 m · 19 mm	6
11347	7,5 m · 25 mm	6



## FESTA

## METR SVINOVACÍ - MAGNET

- 3 x brzda
- magnetický háček
- přibrzdování
- protiskuzové pogumování



Č.p.	specifikace	
11323	3 m · 19 mm	10
11325	5 m · 25 mm	10
11327	7,5 m · 25 mm	6



## FESTA

## METR SVINOVACÍ MAGNETIC

- magnetický háček
- protiskuzové pogumování
- fluorescenční páska
- stupnice s velkými číslicemi



Č.p.	specifikace	
11102	2 m · 16 mm	10
11103	3 m · 16 mm	10
11105	5 m · 19 mm	12
11106	5 m · 25 mm	12
11107	7,5 m · 25 mm	10
11110	10 m · 25 mm	6



## FESTA

## METR SVINOVACÍ

- stupnice s velkými číslicemi



Č.p.	specifikace	
11226	2 m · 16 mm	10
11239	3 m · 19 mm	10
11259	5 m · 19 mm	12
11260	7,5 m · 25 mm	6



## FESTA

## METR SVINOVACÍ

- automatická brzda
- protiskuzové pogumování



Č.p.	specifikace	
11333	3 m · 16 mm	12
11335	5 m · 19 mm	12
11337	7,5 m · 25 mm	6
11338	10 m · 25 mm	6



## FESTA

## METR SVINOVACÍ COMPACT

- malý rozměr metru
- nylonová vrstva



Č.p.	specifikace	
11220	3 m · 16 mm	12
11221	5 m · 19 mm	12



**Johnney®**

**METR SVINOVACÍ**

· matná úprava pásky

**II. class**



Č.p.	specifikace	
11002	2 m · 13 mm	12
11003	3 m · 13 mm	12
11005	5 m · 13 mm	12
11006	5 m · 19 mm	12
11007	7,5 m · 19 mm	12
11008	10 m · 25 mm	12



**METR SVINOVACÍ - ERGO**

· přibrzdňování  
· protiskluzové pogumování



Č.p.	specifikace	
11082	2 m · 16 mm	12
11083	3 m · 16 mm	12
11085	5 m · 19 mm	12



**METR SVINOVACÍ**

· metrická a palcová stupnice  
· protiskluzové pogumování



Č.p.	specifikace	
11416	5 m · 19 mm	10



**METR SVINOVACÍ**

· přibrzdňování



Č.p.	specifikace	
11200	2 m · 13 mm	24
11201	2 m · 16 mm	24
11202	2 m · 19 mm	24
11204	3 m · 13 mm	24
11205	3 m · 16 mm	24
11206	3 m · 19 mm	24
11207	5 m · 19 mm	12
11208	5 m · 25 mm	12
11209	7,5 m · 25 mm	12
11210	10 m · 25 mm	12

**METR SVINOVACÍ SE JMÉNEM  
3M · 16 MM**

**CE II. class**

Č.p.	jméno na metru
13500	JIŘÍ
13501	PETR
13502	JOSEF
13503	TOMÁŠ
13504	JAN
13505	MARTIN
13506	JAROSLAV
13507	FRANTIŠEK
13508	PAVEL

Č.p.	jméno na metru
13509	MIROSLAV
13510	BIG BOSS
13511	ZDENĚK
13512	MICHAL
13513	MILAN
13514	KAREL
13515	VLADIMÍR
13516	DĚDEČEK
13517	MŮJ METR



Č.p.	jméno na metru
13518	VÁCLAV
13519	JAKUB
13520	LUKÁŠ
13521	2X MĚŘ
13522	LADISLAV
13523	DAVID
13524	ROMAN
13525	ŠIKULA
13526	RADEK

Č.p.	jméno na metru
13527	MISTR
13528	ONDŘEJ
13529	MAREK
13530	STANISLAV
13531	BOREC
13532	TATÍNEK
13533	ANTONÍN
13534	ALEŠ



**FESTA**

**PÁSMO OCELOVÉ**

· očko

**CE II. class**



Č.p.	specifikace	
12010	10 m · 10 mm	1
12020	20 m · 10 mm	1
12030	30 m · 10 mm	1
12050	50 m · 10 mm	6



**FESTA**

**PÁSMO SKLOLAMINÁTOVÉ**

· očko

**CE II. class**



Č.p.	specifikace	
12110	10 m · 13 mm	6
12120	20 m · 13 mm	1
12130	30 m · 13 mm	1
12150	50 m · 13 mm	1



**FESTA**

**PÁSMO OCELOVÉ**

· očko + háček

**CE II. class**



Č.p.	specifikace	
12220	20 m · 10 mm	6
12230	30 m · 10 mm	6
12250	50 m · 10 mm	6



**FESTA**

**PÁSMO OCELOVÉ**

· očko



Č.p.	specifikace	
12433	30 m · 12,5 mm	20
12435	50 m · 12,5 mm	10



**KOLEČKO MĚŘICÍ**

- odolné, lehké a kompaktní
- počítadlo přičítá při pohybu vpřed a odečítá při pohybu vzad
- vestavěné osvětlení pro noční práci, 2 baterie AAA v rukojeti
- včetně pouzdra



Č.p.	specifikace	
15989	max. 10 km	2

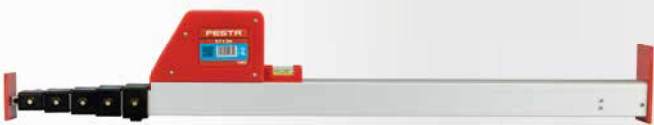

**FESTA**

**TYČ MĚŘICÍ  
TELESKOPICKÁ**

· včetně pouzdra

Č.p.	specifikace	
15983	0,7 - 3 m	10
15985	1,1 - 5 m	10
15988	1,6 - 8 m	5



**PÁSKA KOVOVÁ, MĚŘICÍ  
PLOCHÁ, SAMOLEPICÍ**



Č.p.	specifikace	
11311	1 m · 12,5 mm	30
11312	2 m · 12,5 mm	30
11313	3 m · 16 mm	30
11314	5 m · 19 mm	30



**MĚTR SVINOVACÍ  
PŘÍVĚSEK**

Č.p.	specifikace	
11420	1 m · 6 mm oranžový	24



**FESTA**

**MĚTR SVINOVACÍ  
PŘÍVĚSEK**

- stupnice s velkými číslicemi
- vlastnosti plnohodnotného metru



Č.p.	specifikace	
11410	2 m · 16 mm 6 barev	12



**MĚTR SVINOVACÍ  
PŘÍVĚSEK**

Č.p.	specifikace	
11444	1 m · 6 mm bílý	20



**MĚTR SVINOVACÍ  
PŘÍVĚSEK**

Č.p.	specifikace	
11425	1 m · 6 mm	25



**LIBELA - PŘÍVĚSEK**

Č.p.	specifikace	
11445		100



## METR SKLÁDACÍ



Č.p.	specifikace	
13010	1 m · bílý	20
13020	2 m · bílý	10
13021	1 m · žlutý	20
13022	2 m · žlutý	10
13023	2 m · bílo - žlutý	10

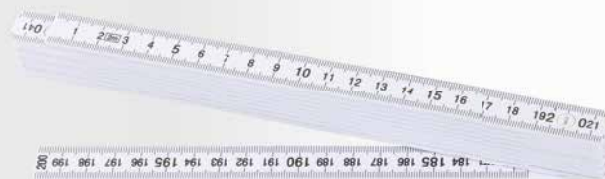
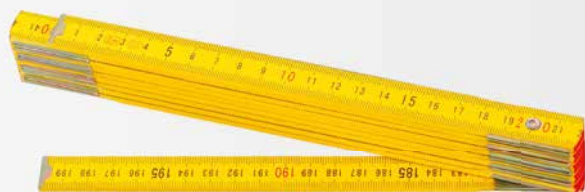
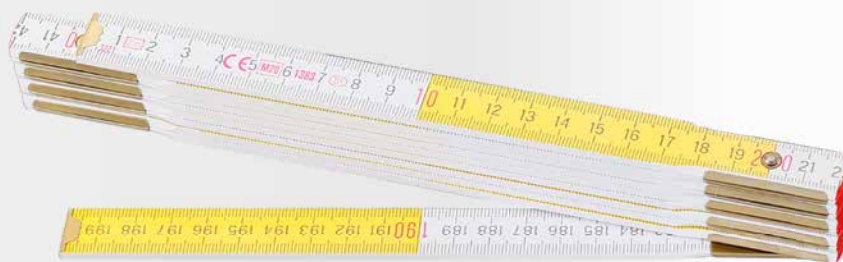

## METR SKLÁDACÍ



Č.p.	specifikace	
13111	1 m · žlutý	10
13120	2 m · žlutý	5

## METR SKLÁDACÍ



Č.p.	specifikace	
13211	1 m	1
13220	2 m	1



## METR SKLÁDACÍ SE JMÉNEM



Č.p.	jméno na metru
13401	JIŘÍ
13402	JAN
13403	PETR
13404	JOSEF
13405	PAVEL
13406	MARTIN
13407	JAROSLAV
13408	TOMÁŠ
13409	MIROSLAV
13410	ZDENĚK
13411	FRANTIŠEK
13412	VÁCLAV
13413	MICHAL
13414	MILAN
13415	KAREL
13416	JAKUB
13417	LUKÁŠ
13418	DAVID
13419	VLADIMÍR
13420	LADISLAV
13421	ONDŘEJ
13422	ROMAN
13423	STANISLAV
13424	MAREK
13425	RADEK

Č.p.	jméno na metru
13426	DANIEL
13427	ANTONÍN
13428	VOJTĚCH
13429	FILIP
13430	ADAM
13431	MILOSLAV
13432	MATĚJ
13433	ALEŠ
13434	JAROMÍR
13435	LIBOR
13436	DOMINIK
13437	PATRIK
13438	VLASTIMIL
13439	JINDŘICH
13440	MILOŠ
13441	JÁN
13442	PETER
13443	ONDŘEJ
13444	JOZEF
13445	PAVOL
13446	L'UBOMÍR
13447	KAROL
13448	RADOSLAV
13449	VOJTĚCH
13450	ZDENKO

Č.p.	jméno na metru
13451	JANA
13452	EVA
13453	PETRA
13454	MAJKA
13455	HANA
13456	ANNA
13457	LENKA
13458	KATKA
13459	LUCIE
13460	ALENA
13461	VERONIKA
13462	MARTINA
13463	JITKA
13464	BIG BOSS
13465	2 x MĚŘ
13466	TATÍNEK
13467	DĚDEČEK
13468	ŠIKULA
13469	MISTR
13470	MACHR
13471	BOREC
13472	UŽ JE MŮJ
13473	MŮJ METR

## STOJAN NA SKLÁDACÍ METRY

· osazení stojanu 13399

- 13401 · 15 ks
- 13402 · 15 ks
- 13403 · 15 ks
- 13404 · 15 ks
- 13405 · 15 ks
- 13406 · 15 ks
- 13412 · 15 ks
- 13413 · 15 ks
- 13414 · 15 ks
- 13415 · 15 ks
- 13416 · 15 ks
- 13417 · 15 ks
- 13418 · 15 ks
- 13419 · 15 ks
- 13420 · 15 ks
- 13421 · 10 ks
- 13422 · 10 ks
- 13423 · 10 ks
- 13424 · 10 ks
- 13425 · 10 ks
- 13426 · 10 ks
- 13427 · 10 ks
- 13428 · 10 ks
- 13429 · 10 ks
- 13430 · 10 ks
- 13431 · 10 ks
- 13432 · 10 ks
- 13433 · 10 ks
- 13434 · 10 ks
- 13435 · 10 ks
- 13436 · 10 ks
- 13437 · 10 ks
- 13438 · 10 ks
- 13439 · 10 ks
- 13440 · 10 ks



Č.p.	specifikace	
13399	Stojan osazený	1
13400	Stojan bez metrů	1

**FESTA****MĚŘIDLO POSUVNÉ DIGITÁLNÍ**

INOX	Č.p.	specifikace	
	14007	150   0,01 mm	10
	14008	200   0,01 mm	10
	14009	300   0,01 mm	10

**MĚŘIDLO POSUVNÉ DIGITÁLNÍ FIBERGLASS**

· přesnost 0,2 mm, rozlišení 0,1 mm

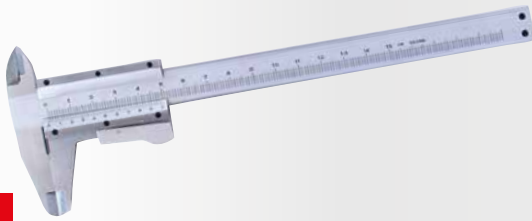

Č.p.	specifikace	
14013	150   0,2 mm	10

**FESTA****MĚŘIDLO POSUVNÉ**

INOX	Č.p.	specifikace	
	14004	150   0,02 mm	10

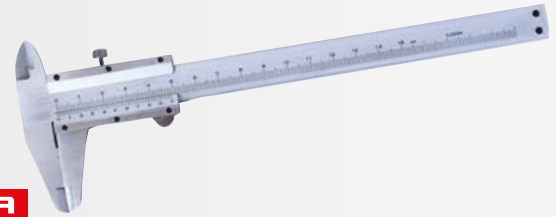
**FESTA****MĚŘIDLO POSUVNÉ**

INOX	Č.p.	specifikace	
	14001	150   0,02 mm	10
	14002	200   0,02 mm	10
	14003	300   0,02 mm	10

**FESTA****MIKROMETR**

Č.p.	specifikace	
14040	0 - 0,25   0,01 mm	10
14045	25 - 50   0,01 mm	10

**MĚŘIDLO POSUVNÉ****HOBBY**

Č.p.	specifikace	
14006	150 mm	50

**FESTA****ÚCHYLKOMĚŘ**

INOX	Č.p.	specifikace	
	14035	0 - 10mm   0,01 mm	10

**MĚŘKY SPÁROVÉ**

· 20 listů



Č.p.	specifikace	
14080	0,05 - 1 mm	10

**KRUŽÍTKO RÝSOVACÍ**

Č.p.	specifikace	
13285	200 mm	10

**FESTA****JEHLA RÝSOVACÍ**

Č.p.	specifikace	
13281	150 mm	50

**FESTA****JEHLA RÝSOVACÍ**

Č.p.	specifikace	
13282	200 mm	50

## FESTA

### MĚŘÍTKO S RUKOJETÍ

ALU



Č.p.	specifikace	
14030	600 mm	6

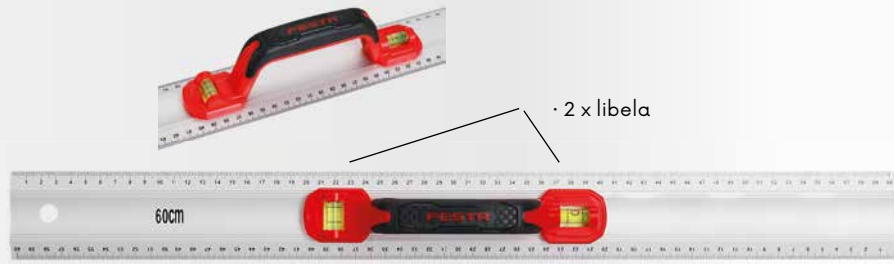

## FESTA

### MĚŘÍTKO HLINÍKOVÉ

ALU



Č.p.	specifikace	
14015	400 mm	48
14017	600 mm	50
14019	1000 mm	40



## FESTA

### MĚŘÍTKO OCELOVÉ

INOX



Č.p.	specifikace	
14010	300 mm	10
14011	600 mm	10
14012	1000 mm	10

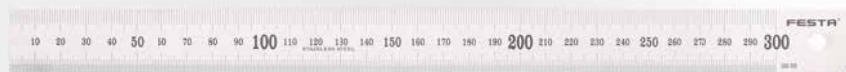

## FESTA

### ÚHLOMĚŘ S OTOČNÝM RAMENEM

· včetně pouzdra

Č.p.	specifikace	
14060	0° - 180° · 150 x 200 mm	10
14070	0° - 180° · 300 x 500 mm	5

### ÚHLOMĚŘ

HOBBY

Č.p.	specifikace	
14075	0° - 180° · 230 x 500 mm	30



### PRAVÍTKO VÍCEÚČELOVÉ SKLÁDACÍ

Č.p.	specifikace
14077	



10



MĚŘÍTKO VÍCEÚČELOVÉ



Č.p.	specifikace	
14480	250 x 120 mm	1



zámek

ŠABLONA NA KOPÍROVÁNÍ TVARŮ



Č.p.	specifikace	
14090	125 x 30 mm	1
14091	250 x 30 mm	1



FESTA

ÚHELNÍK MULTIFUNKČNÍ 3D



Č.p.	Specifikace	
14418		10



FESTA

ÚHELNÍK TRUHLÁŘSKÝ MULTIFUNKČNÍ



Č.p.	specifikace	
14420	180 mm	10
14421	300 mm	10

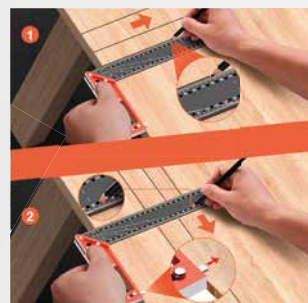
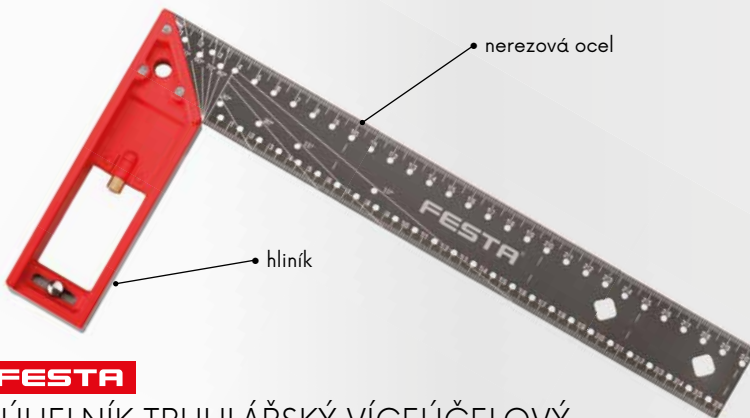

FESTA

ÚHELNÍK TRUHLÁŘSKÝ VÍCEÚČELOVÝ



Č.p.	Specifikace	
14415	300 mm	6
14417	400 mm	6



**FESTA**

## ÚHELNÍK SKLÁDACÍ

**ALU**



Č.p.	specifikace	
14445	600 x 600 mm	1
14446	1200 x 1200 mm	1



**FESTA**

## ÚHELNÍK

**ALU**



Č.p.	specifikace	
14450	190 x 355 mm	6
14451	200 x 405 mm	6

**FESTA**

## ÚHELNÍK TRUHLÁŘSKÝ



Č.p.	specifikace	
14220	200 x 125 mm	10
14225	250 x 135 mm	10
14230	300 x 135 mm	10
14235	350 x 190 mm	10
14240	400 x 190 mm	10
14250	500 x 210 mm	10



**FESTA**

## ÚHELNÍK TESAŘSKÝ



Č.p.	specifikace	
14350	500 x 235 mm	10
14360	600 x 300 mm	10
14370	700 x 300 mm	10
14380	800 x 320 mm	10
14399	1000 x 360 mm	10



## ÚHELNÍK

Č.p.	specifikace	
14410	300 x 200 mm	50
14411	600 x 400 mm	36

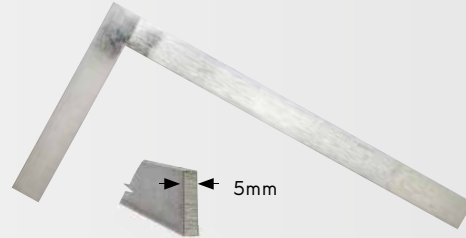

## ÚHELNÍK PLOCHÝ

**Zn**

Č.p.	specifikace	
14471	150 x 100 mm	25
14472	250 x 125 mm	25
14473	400 x 200 mm	30
14474	600 x 300 mm	25

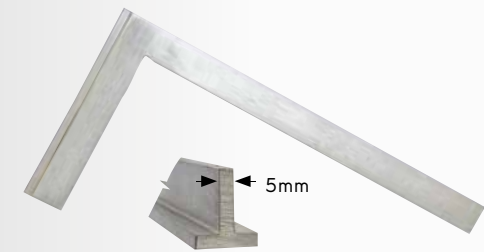

## ÚHELNÍK PŘÍLOŽNÝ

**Zn**

Č.p.	specifikace	
14490	100 x 50 mm	10
14491	150 x 75 mm	10
14492	250 x 125 mm	10
14493	400 x 200 mm	10
14494	600 x 300 mm	10



## ÚHELNÍK ZEDNICKÝ

Č.p.	specifikace	
14455	300 x 200 mm	50
14456	500 x 250 mm	50
14457	700 x 300 mm	40
14458	1000 x 450 mm	30



## ÚHELNÍK TRUHLÁŘSKÝ

**ALU HOBBY**

Č.p.	specifikace	
14425	250 x 130 mm	12
14430	300 x 130 mm	12
14435	350 x 156 mm	12
14440	400 x 156 mm	12



## POKOSNÍK DŘEVĚNÝ



Č.p.	specifikace	
14025	255 x 285 mm	1

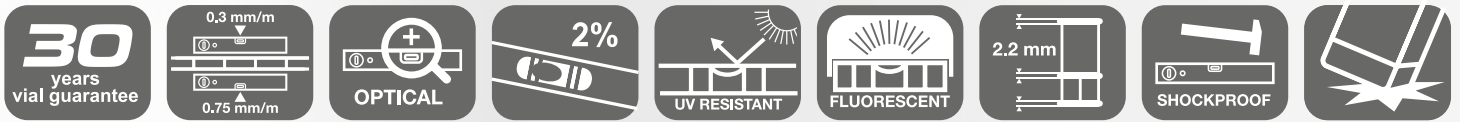

Každý kus je elektronicky testován a má své evidenční číslo, výrobce je držitelem certifikátu ISO 9001



**HORIZONT**  
MASTER



**HORIZONT.**

VODOVÁHA MASTER, 2 LIBELY

<b>ALU</b>			
Č.p.	specifikace		
15033	60 cm		10



**HORIZONT.**

VODOVÁHA MASTER, 3 LIBELY

<b>ALU</b>			
Č.p.	specifikace		
15034	80 cm		10
15035	100 cm		10



**HORIZONT.**

VODOVÁHA MASTER, 3 LIBELY, S MADLY

<b>ALU</b>			
Č.p.	specifikace		
15036	120 cm		10
15037	150 cm		10
15039	200 cm		10

# HORIZONT®

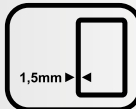
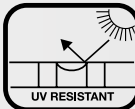
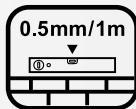

Každý kus je elektronicky testován a má své evidenční číslo, výrobce je držitelem certifikátu ISO 9001

## HORIZONT® VODOVÁHA, 2 LIBELY



Č.p.	specifikace	
15003	30 cm	30
15004	40 cm	30
15005	50 cm	30
15006	60 cm	30
15008	80 cm	30
15010	100 cm	30
15012	120 cm	10
15015	150 cm	10
15018	180 cm	10
15020	200 cm	10



## HORIZONT® VODOVÁHA, 3 LIBELY



Č.p.	specifikace	
15103	30 cm	30
15104	40 cm	30
15105	50 cm	30
15106	60 cm	30
15108	80 cm	30
15110	100 cm	30
15112	120 cm	10
15115	150 cm	10
15118	180 cm	10
15120	200 cm	10



## HORIZONT® VODOVÁHA, 2 LIBELY + MAGNET



Č.p.	specifikace	
15204	40 cm	30
15205	50 cm	30
15206	60 cm	30
15208	80 cm	30
15210	100 cm	30
15212	120 cm	10
15215	150 cm	10
15218	180 cm	10
15220	200 cm	10



## HORIZONT® VODOVÁHA SKLONOVÁ, 4 LIBELY



Č.p.	specifikace	
15230	80 cm	10



**HORIZONT**

VODOVÁHA SKLONOVÁ, 1 LIBELA



Č.p.	specifikace	
15235	60 cm	1

**HORIZONT**

LAŤ STAHOVACÍ - BEZ LIBEL

ALU

Č.p.	specifikace	
15310	100 cm	10
15315	150 cm	10
15318	180 cm	10
15320	200 cm	10
15325	250 cm	10
15330	300 cm	10
15335	350 cm	10
15340	400 cm	10

**HORIZONT**

LAŤ STAHOVACÍ - 1 LIBELA

ALU

Č.p.	specifikace	
15415	150 cm	10
15418	180 cm	10
15420	200 cm	10
15425	250 cm	10
15430	300 cm	10

**HORIZONT**

LAŤ STAHOVACÍ - 2 LIBELY

ALU

Č.p.	specifikace	
15510	100 cm	10
15515	150 cm	10
15518	180 cm	10
15520	200 cm	10
15525	250 cm	10
15530	300 cm	10
15535	350 cm	10
15540	400 cm	5

**HORIZONT**

LAŤ STAHOVACÍ - 2 MADLA, BEZ LIBEL

ALU

Č.p.	specifikace	
15615	150 cm	10
15620	200 cm	10
15625	250 cm	10
15630	300 cm	10



## HORIZONT

### LAŤ STAHOVACÍ - 2 MADLA, 2 LIBELY

ALU

Č.p.	specifikace	
15710	100 cm	10
15715	150 cm	10
15720	200 cm	10
15725	250 cm	10
15730	300 cm	10
15735	350 cm	10
15740	400 cm	5



## HORIZONT

### LAŤ STAHOVACÍ - TRAPÉZOVÝ PROFIL

PROFIL TRAPÉZOVÝ

- trapézový profil slouží k jemnějším úpravám povrchu
- vhodné pro štukatéry a fasádníky
- vhodný pro tenkovrstvé omítky

ALU

Č.p.	specifikace	
15810	100 cm	10
15812	120 cm	10
15815	150 cm	10
15818	180 cm	10
15820	200 cm	10
15825	250 cm	10
15830	300 cm	10



## HORIZONT

### LAŤ STAHOVACÍ - H PROFIL

PROFIL "h"

- "h" profil slouží k jemnějším úpravám povrchu
- vhodné pro štukatéry a fasádníky
- vhodná ke štukování stropních omítek

ALU

Č.p.	specifikace	
15850	100 cm	10
15853	150 cm	10
15855	180 cm	10
15860	200 cm	10
15870	250 cm	10
15880	300 cm	10

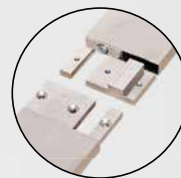

NEW

## HORIZONT

### SPOJKA PRO STAHOVACÍ LAŤE HORIZONT

ALU

Č.p.	Specifikace		
15301		1	



## HORIZONT

### STAHOVACÍ LAŤ NASTAVITELNÁ

ALU

Č.p.	Specifikace	
15893	65 - 100 cm	1
15894	95 - 150 cm	1
15895	145 - 235 cm	1

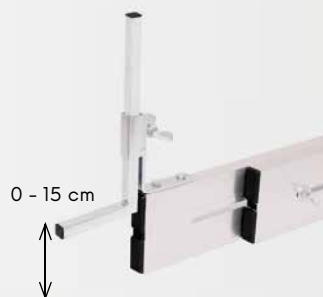

0 - 15 cm

## HORIZONT

### ÚHELNÍK STAVEBNÍ

ALU

Č.p.	specifikace	
14485	800 x 1200 mm	1
14486	1000 x 1500 mm	1



**HORIZONT.**  
STOJAN  
NA VODOVÁHY

· osazení stojanu 15998

- 15003 · 5 ks
- 15004 · 5 ks
- 15005 · 5 ks
- 15006 · 5 ks
- 15008 · 5 ks
- 15010 · 5 ks
- 15012 · 5 ks
- 15015 · 3 ks
- 15018 · 3 ks
- 15020 · 3 ks
- 15108 · 3 ks
- 15206 · 3 ks
- 15210 · 3 ks

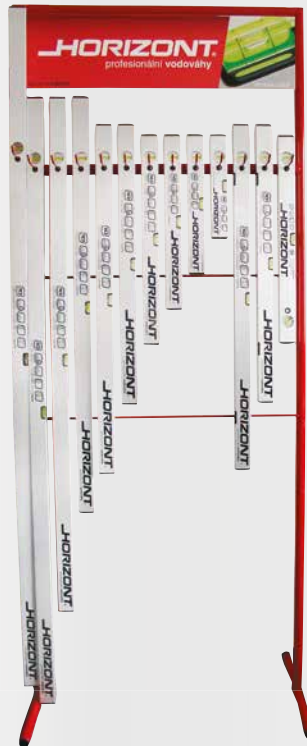

**HORIZONT.**  
STOJAN  
NA VODOVÁHY A LATĚ

· osazení stojanu 15996

- 15004 · 5 ks
- 15005 · 5 ks
- 15006 · 5 ks
- 15008 · 5 ks
- 15010 · 5 ks
- 15012 · 5 ks
- 15015 · 5 ks
- 15018 · 5 ks
- 15020 · 5 ks
- 15315 · 2 ks
- 15320 · 2 ks
- 15325 · 3 ks
- 15515 · 2 ks
- 15520 · 2 ks
- 15525 · 3 ks



Č.p.	specifikace	
15999	85 x 210 x 50 cm	1
15998	85 x 210 x 50 cm osazený	1

Č.p.	specifikace	
15997	55 x 75 x 40 cm	1
15996	55 x 75 x 40 cm osazený	1

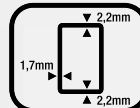
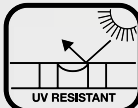

**NEW**

**FESTO**  
VODOVÁHA,  
3 LIBELY



Č.p.	Specifikace	
15754	400 mm	1
15756	600 mm	1
15758	800 mm	1
15760	1000 mm	1
15762	1200 mm	1
15768	1800 mm	1
15770	2000 mm	1



## NIVELA

### VODOVÁHA NIVELA - 2 LIBELY

- Přesnost 0,5 mm | 1 m (v základní poloze)
- UV stabilní kapalina libely
- Nárazuvzdorné gumové koncovky
- Tloušťka profilu základny 2,4 mm



Č.p.	specifikace	
15904	40 cm	30
15906	60 cm	30
15908	80 cm	30
15910	100 cm	30
15912	120 cm	20
15915	150 cm	10
15920	200 cm	20



### VODOVÁHA - 3 LIBELY

**ALU HOBBY**

Č.p.	specifikace	
15954	40 cm	60
15956	60 cm	60
15958	80 cm	60
15960	100 cm	30
15962	120 cm	30
15965	150 cm	30
15970	200 cm	30



### VODOVÁHA NA PROVÁZEK



Č.p.	specifikace	
15981		1



Č.p.	specifikace	
15980	230 mm	1

### VODOVÁHA S MAGNETEM, 3 LIBELY

### VODOVÁHA SLOUPKOVÁ

- 3 libely, magnety, fixační pásek



Č.p.	specifikace	
26028		12



### VODOVÁHA HADICOVÁ



Č.p.	specifikace	
15992	skleněné trubice - hadice 10 m	1
15993	skleněné trubice - hadice 15 m	1
15990	skleněné trubice	50
15991	plastové trubice	50



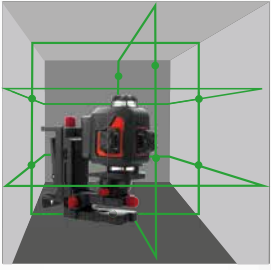

NEW

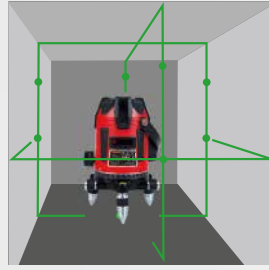

NEW

**FESTA****LASER ALL LINE ZELENÝ 4 x 360 °**

- 2x horizontální rovina + 2x vertikální rovina (zelený paprsek)
- samonivelační rozsah  $\pm 4^\circ$
- přesnost: 0,2 mm/m
- ve vnitřních prostorech 30 m, s laserovým přijímačem až 50 m
- pulzní režim – doporučené příslušenství přijímač 26209
- dodáváno s: přepravní kufr, dálkové ovládání, laserový terč, Li-ion baterie 5200 mAh, profesionální držák, mini stativ, nabíječka

$\pm 4^\circ$	max. 50 m	$\pm 0.2$ mm/m	II. class	515 nm
1/4"	5/8"	IP54	Li-ion 3.7V 5.2Ah	1

Č.p. Specifikace

26205



1

**FESTA****LASER ZELENÝ KŘÍŽOVÝ**

- 1x horizontální rovina + 4x vertikální rovina (zelený paprsek) + 1x bod
- samonivelační rozsah  $\pm 3^\circ$
- přesnost: 0,2 mm/m
- ve vnitřních prostorech 20 m, s laserovým přijímačem až 50 m
- pulzní režim – doporučené příslušenství přijímač 26209
- dodáváno s: přepravní kufr, laserový terč, Li-ion baterie 5200 mAh, profesionální držák, mini stativ, nabíječka

$\pm 3^\circ$	max. 50 m	$\pm 0.2$ mm/m	II. class	515 nm
5/8"	IP54	Li-ion 3.7V 5.2Ah	1	

Č.p. Specifikace

26203



1

**FESTA**



**FESTA**

**LASER ALL LINE ZELENÝ 3 X 360 °**

- 1x horizontální rovina + 2x vertikální rovina (zelený paprsek)
- samonivelační rozsah  $\pm 4^\circ$
- přesnost: 0,2 mm/m
- ve vnitřních prostorech 30 m, s laserovým přijímačem až 50 m
- pulzní režim – doporučené příslušenství přijímač 26209
- dodáváno s: přepravní kufr, 4 x AA alkalické baterie, laserový terč, brýle, Li-ion baterie 2600 mAh, profesionální držák, nabíječka, držák Li-ion baterie

 $\pm 4^\circ$	 INDOOR 30 m OUTDOOR 50 m	 $\pm 0.2$ mm/m	 II. class	 515 nm
 IP 54	 5/8"	 1/4"	 4x AA	 Li-ion 7,4V 2,6Ah



Č.p. Specifikace

26204

1



**FESTA**

**LASER ZELENÝ KRÍŽOVÝ**

- 1x horizontální rovina + 1x vertikální rovina (zelený paprsek) |
- samonivelační rozsah  $\pm 3^\circ$
- přesnost: 0,2 mm/m
- ve vnitřních prostorech 20 m, s laserovým přijímačem až 50 m
- pulzní režim – doporučené příslušenství přijímač 26209
- dodáváno s: přepravní pouzdro, 2 x AA alkalické baterie, držák

 $\pm 3^\circ$	 INDOOR 20 m OUTDOOR 50 m	 $\pm 0.2$ mm/m	 II. class	 515 nm
 IP 54	 1/4"	 2x AA		



Č.p. Specifikace

26201

1

**FESTA**

**DÁLKOMĚR**

- rozsah měření 0,05 - 50 m
- přesnost měření  $\pm 2$  mm, jednotka měření mm/in/ft
- kontinuální měření, měření plochy, měření objemu, výpočet délky třetí strany dle Pythagorovy věty, LCD FSTN, sčítání/odčítání, max./min. měření
- maximální úložisko na 100 hodnot, čtyřřádkový display LCD FSTNS s podsvícením,
- vlnová délka laseru 630 - 670 nm, pracovní teplota 0 - 40°C
- rozměry 112 x 50 x 25 mm, hmotnost 90 g
- dodáváno s: přepravní pouzdro, 2xAAA alkalické baterie

 max 50 m	 $\pm 2$ mm	 m in ft	 630 670 nm
 IP 54	 2x AAA		

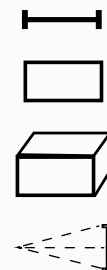

Č.p. Specifikace

26211

1



1/4" + 5/8"



60 - 150 cm

**FESTA**

**LASEROVÝ PŘIJÍMAČ**

- pro lasery s pulsním režimem k prodloužení dosahu až 50 m
- dodáváno s: 9 V baterie, držák
- pro 26201, 26203, 26204, 26205

<b>max</b> 50 m	<b>±1.5 mm</b> 10 m	<b>5 kHz</b>	<b>IP54</b>	<b>1x 9V</b>
--------------------	------------------------	--------------	-------------	--------------



**STATIV**

**ALU**



Č.p.	Specifikace	1
26209	dosah: 50 m	1

Č.p.	Specifikace	1
26219	60 - 150 cm 1/4" + 5/8"	1



**FESTA**

**SKLONOMĚŘ DIGITÁLNÍ**

- 0° - 360°
- přesnost ±0,1°
- rozlišení 0,1°
- funkce automatického vypnutí
- funkce HOLD pro uchování naměřené hodnoty
- podsvícený display
- specifikace 60x60x25 mm
- baterie 1xAAA



· pouzdro

· magnetická spodní strana

<b>0-360°</b>	<b>0,1°</b> LCD DISPLAY	<b>1x AAA</b>	<b>0-50°C</b>	<b>82 g</b>
---------------	----------------------------	---------------	---------------	-------------

Č.p.	specifikace	1
26218		1



**FESTA**

**ÚHLOMĚŘ DIGITÁLNÍ**

<b>200 mm</b>	<b>mm</b> <b>inch</b>	<b>LCD DISPLAY</b>	<b>0°-360°</b>
<b>0.05°</b>	<b>+/- 0.2°</b>	<b>MANUAL LOCKING</b>	<b>1x CR2032 3V</b>



**FESTA**

**VODOVÁHA S DIGITÁLNÍM ÚHLOMĚŘEM**

- LCD display
- rozsah měření 0° - 225°
- rozlišení 0,1°
- přesnost ± 0,3

<b>ALU</b>	<b>0,1°</b> LCD DISPLAY	<b>3V LITHIUM</b>
------------	----------------------------	-------------------



Č.p.	specifikace	1
26217	200 mm	1

Č.p.	specifikace	1
26216	300 mm	1

## FESTA

### MULTIMETR

- měření napětí DC: 200 mV - 300 V
- měření napětí AC: 200 mV - 300 V
- měření proudu DC: 2000  $\mu$ A - 10 A
- měření odporu: 200  $\Omega$  - 2 M $\Omega$
- kontrola baterií: 1,5 V, 9 V
- indikace slabé baterie
- ochrana proti přetížení

- IEC61010
- CATIII 300 V
- certifikát GS
- napájení: 9 V baterie (6F22)
- rozměry: 70x128x28 mm
- hmotnost: 137 g (s baterií)
- příslušenství: testovací kabely



Č.p. Specifikace

18429



1



## FESTA

### ZKOUŠEČKA NAPĚTÍ

- AC / DC - 6 V, 12 V, 24 V, 50 V, 120 V, 230 V, 400 V
- odolnost proti vniknutí vody IP54
- určení polarity
- CAT III 400 V



Č.p. Specifikace

18428



1



## Laserliner®

### LUXTEST-MASTER

Profesionální měřicí přístroj intenzity osvětlení

- měření intenzity osvětlení na pracovištích, kancelářích, veřejných budovách a v průmyslu
- citlivé fotodiody s kosinovou korekcí pro širokouhlé měření světla
- relativní funkce měření pro referenční měření a porovnávání
- špičková funkce pro registraci rychlé změny v úrovni osvětlení.
- funkce automatického zapamatování hodnoty.
- automatické a manuální přepínání rozsahu
- funkce nulování
- měření proměnné: lux (lm /m<sup>2</sup>), nožní svíčky (lm /ft<sup>2</sup>)
- min. | max. displej
- 1 | 4" závit pro umístění na stativ



Č.p. specifikace

Rozsah měření: 20 Lux ... 200000 Lux

26520 Přesnost:  $\pm 3\%$  (referenční hodnota 2854 K)

Kosinus úhlová odchylka:  $\pm 2\%$  (30°),  $\pm 6\%$  (60°)



1

specifikace

Dodáno s: baterie, přepravní kufr

## Laserliner®

### AIRFLOWTEST-MASTER

Profesionální anemometr pro měření průtoku vzduchu, objemového průtoku a rychlosti větru

- integrovaný senzor pro měření okolní teploty, relativní vlhkosti a rosného bodu
- usb rozhraní pro ukládání naměřených dat
- pc software
- velké oběžné kolo: 65 mm.
- min. | max. displej.
- 1 | 4" závit pro připojení na stativ při dlouhodobém měření
- osvětlený, přehledný displej s trvale viditelnými hodnotami okolní teploty a relativní vlhkosti



Č.p. specifikace

Průtok: 0.80...30 m /s |  $\pm 2\%$

26521 Teplota okolního prostředí: -10...60°C |  $\pm 1.5^\circ\text{C}$

Relativní vlhkost vzduchu: 20%...80% |  $\pm 3\%$

Proud vzduchu: 0...99990 CMM



NAHRÁVÁNÍ DAT NA PC

specifikace

Dodáno s: PC software, USB kabel, baterie, přepravní kufr



1

**FESTA**

## TUŽKA TESAŘSKÁ HB

MOQ  
12

Č.p.	specifikace	
13270	HB · 180 mm	96
13271	HB · 180 mm · sada 3 ks	32
13265	HB · 250 mm	96

**FESTA**

## TUŽKA TESAŘSKÁ HB

MOQ  
50

Č.p.	specifikace	
13269	HB · 180 mm	50
13266	HB · 250 mm	50

**FESTA**

## TUŽKA TESAŘSKÁ HB

MOQ  
12

Č.p.	specifikace	
13272	HB · 250 mm	96
13264	HB · 250 mm · bez potisku	96

**FESTA**

## TUŽKA TESAŘSKÁ HB

MOQ  
50

Č.p.	specifikace	
13268	250 mm	50

**FESTA**

## TUŽKA TROJHRANNÁ HB

MOQ  
12

Č.p.	specifikace	
13278	250 mm	96

**FESTA**

## TUŽKA 6H

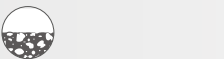
MOQ  
12

Č.p.	specifikace	
13275	6H · 250 mm	96

**FESTA**

## TUŽKA NA SKLO A KERAMIKU

MOQ  
12

Č.p.	specifikace	
13273	175 mm červená tuha - sklo, keramika	144

**FESTA**

## TUŽKA S BAREVNOU TUHOU

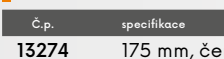
MOQ  
12

Č.p.	specifikace	
13274	175 mm, červeno - modrá	96



## TUŽKA TESAŘSKÁ HB



MOQ  
12

Č.p.	specifikace	
13280	180 mm	96



## TUŽKA S ČERVENOU TUHOU

Č.p.	specifikace	
13276	175 mm	144



smírek

## OŘEZÁVÁTKO NA TUŽKY

Č.p.		
13261		12



**FESTA**

## ZNAČKOVAČ HLOUBKOVÝ HB

· náhradní tuhy 13263, 13267



Č.p.	specifikace	
13288		20



**FESTA**

## ZNAČKOVAČ HLOUBKOVÝ HB

· náhradní tuhy 13263, 13267



Č.p.	specifikace	
13262	150 mm	20



**FESTA**

## TUŽKA S VÝMĚNITELNOU TUHOU HB



Č.p.	specifikace	
13279	tužka + náhradní tuha HB	24
13284	náhradní tuhy 5 ks	20

**FESTA**

## BAREVNÉ TUHY DO HLOUBKOVÉHO ZNAČKOVAČE

· pro 13262, 13288



Č.p.	Specifikace	
13267	● 2x žlutá ● 2x červená ● 2x modrá	1

**FESTA**

## ČERNÉ TUHY HB DO HLOUBKOVÉHO ZNAČKOVAČE

· pro 13262, 13288



Č.p.	Specifikace	
13263	● 6x černá	20





## ZNAČKOVACĚ PERMANENTNÍ



Č.p.	Specifikace	
13200	○ bílý	1
13201	● černý	1
13202	● červený	1



NEW

## ZNAČKOVACĚ PERMANENTNÍ



- extra silný hrot
- pro značení i na mastných a vlhkých površích



Č.p.	specifikace	
13216	červený	12
13217	černý	12
13218	modrý	12
13219	zelený	12



## ZNAČKOVACĚ PERMANENTNÍ



- 2 typy hrotu značkovače
- pro značení i na mastných a vlhkých površích



Č.p.	specifikace	
13227	bílý	ALU pouzdro 40
13222	bílý	PVC pouzdro 12
13228	červený	ALU pouzdro 40
13229	černý	ALU pouzdro 40
13230	modrý	ALU pouzdro 12
13231	zelený	ALU pouzdro 12



## ZNAČKOVACĚ PERMANENTNÍ



Č.p.	specifikace	
13214	bílý	12
13225	červený	12
13226	černý	12
13223	modrý	12
13224	zelený	12



## ZNAČKOVACĚ PERMANENTNÍ



Č.p.	specifikace	
13235	červený	12
13236	černý	12
13237	modrý	12
13238	zelený	12



**FESTA**

ZNAČKOVAČ HLOUBKOVÝ,  
PERMANENTNÍ



Č.p.	Specifikace	
13246	● černý	1
13247	● červený	1
13248	○ bílý	1



ZNAČKOVAČ PERMANENTNÍ,  
OBOUSTRANNÝ



MOQ  
12



Č.p.	Specifikace	
13206	○ bílý	12



ZNAČKOVAČ PERMANENTNÍ,  
OBOUSTRANNÝ



MOQ  
12



Č.p.	specifikace	
13212	● černý	12



ZNAČKOVAČ PERMANENTNÍ,  
OBOUSTRANNÝ



MOQ  
12



Č.p.	Specifikace   Specification	
13207	● červený	12
13208	● modrý	12



ZNAČKOVAČ PERMANENTNÍ MINI



· délka fixu 9 cm



MOQ  
72



Č.p.	specifikace	
13205	● ● ● ● ●	72



**FESTA**

**ZNAČKOVAČ  
UNIVERZÁLNÍ SADA 5 KS**

· Ø 13 x 110 mm

**5x**



Č.p.	specifikace	
13240	5 barev	20
13241	červená	20
13242	černá	20

Č.p.	specifikace	
13243	žlutá	20
13244	zelená	20
13245	obílá	20



**DRŽÁK POJÍZDNÝ  
NA SPREJ SOPPEC**

· pro spreje Trackmarker a Fluo



Č.p.	specifikace	
13296		1



**TUŽKY VOSKOVÉ  
SADA 6 KS**

**6x**



Č.p.	specifikace	
13277		88



**KŘÍDA BÍLÁ**

**12x**



Č.p.	specifikace	
13260	12 x 12 x 80 mm	46



**DRŽÁK PISTOLOVÝ NA SPREJ SOPPEC**

· pro spreje Trackmarker a Fluo



Č.p.	specifikace	
13295		1





## SPREJ FLUORESCENČNÍ TRACKMARKER 500ML

- vysoká viditelnost - fluorescenční pigment
- bezpečnostní víčko
- rychleschnoucí 10 min.
- trvanlivost 3 měsíce
- použití - beton, asfalt, tráva, štěrky, písek, kámen, dřevo



Č.p.	specifikace	
13250	● žlutý	12
13251	● červený	12
13252	● oranžový	12
13253	● zelený	12
13254	● růžový	12
13249	● modrý	12



## SPREJ FLUORESCENČNÍ MARK 6M FLUO 500 ML

- vysoká viditelnost - fluorescenční pigment
- bezpečnostní víčko
- rychleschnoucí 10 min.
- trvanlivost 6 měsíců
- použití - beton, asfalt, tráva, štěrky, písek, kámen, dřevo, sklo



Č.p.	specifikace	
13360	● žlutý	12
13361	● červený	12
13362	● oranžový	12
13363	● zelený	12
13364	● růžový	12
13365	○ bílý	12



## SPREJ FLUORESCENČNÍ FLUO 500 ML

- vysoká viditelnost - fluorescenční pigment
- bezpečnostní víčko
- rychleschnoucí 10 min.
- trvanlivost 12 měsíců
- použití - beton, asfalt, tráva, štěrky, písek, kámen, dřevo, sklo



Č.p.	specifikace	
13350	● žlutý	12
13351	● červený	12
13352	● oranžový	12
13353	● zelený	12
13354	● růžový	12
13355	○ bílý	12



## SPREJ FLUORESCENČNÍ IDEAL 500 ML

- vysoká viditelnost - fluorescenční pigment
- bezpečnostní víčko
- rychleschnoucí 10 min.
- trvanlivost 12 měsíců
- použití - beton, asfalt, tráva, štěrky, písek, kámen, dřevo



Č.p.	specifikace	
13255	● žlutý	12
13256	● červený	12
13257	● oranžový	12
13258	● zelený	12
13259	● růžový	12



**KDS®**

Nože japonské firmy KDS

- vynikající ergonomie rukojetí
- vysoký výkon a životnost břitů
- nejlepší použité materiály břitů
- nízký řezný odpor umožňující lehký řez

**KDS®**  
NŮŽ ODLAMOVCÍ

Č.p.	specifikace		
16002	LC405 18 mm zelený	25	
16011	LB10 náhradní čepele	10	

**KDS®**  
NŮŽ ODLAMOVCÍ

Č.p.	specifikace		
16003	G11 18 mm + 2 čepele	10	
16012	GB10 náhradní čepele	10	

**KDS®**  
NŮŽ ODLAMOVCÍ

Č.p.	specifikace		
16019	L19 18 mm + 2 čepele	10	
16011	LB10 náhradní čepele	10	
16012	GB10 náhradní čepele	10	

**KDS®**  
NŮŽ ODLAMOVCÍ

Č.p.	specifikace		
16004	H11 25 mm	10	
16013	HB10 náhradní čepele	10	

**KDS®**  
NŮŽ ODLAMOVCÍ

Č.p.	specifikace		
16005	S14 9 mm + 2 čepele	10	
16010	SB10 náhradní čepele	10	

**KDS®**  
SKALPEL

Č.p.	specifikace		
16006	D12 + 16 čepelí	10	

**KDS®**  
ČEPEL NÁHRADNÍ KDS

10x

Č.p.	specifikace		
16010	SB10 9   0,38 mm	13 segmentů	20
16011	LB10 18   0,5 mm	15 segmentů	20
16012	GB10 18   0,6 mm	15 segmentů	20
16013	HB10 25   0,7 mm	7 segmentů	10

**KDS®**  
ČEPEL NÁHRADNÍ KDS

- speciální slitina
- dvojitá broušení
- zvýšená životnost
- nízký řezný odpor
- umožňující lehké řezání



Č.p.	specifikace		
16016	LB10B 18   0,5 mm	8 segmentů	20
16017	HB10B 25   0,7 mm	7 segmentů	10

**KDS®**  
STOJAN NA ODLAMOVCÍ NOŽE

Č.p.	specifikace		
16999	reklamní stojan	1	
16998	osazený reklamní stojan	1	



- osazení stojanu 16998 : 16001 · 5 ks
- 16003 · 5 ks
- 16004 · 3 ks
- 16005 · 3 ks
- 16006 · 2 ks
- 16008 · 3 ks
- 16010 · 4 ks
- 16012 · 4 ks
- 16013 · 1 ks
- 16016 · 4 ks
- 16018 · 4 ks
- 16019 · 4 ks
- 16020 · 4 ks

· ilustrační foto



**FESTA**



system pro odlamování čepele



**FESTA**  
INDUSTRY

**NŮŽ ODLAMOVACÍ**

protiskuzové pogumování



Č.p.	specifikace	
16099	18 mm	12

**FESTA**<sup>®</sup>



**FESTA**<sup>®</sup>

**NŮŽ ODLAMOVACÍ S KERAMICKOU ČEPELÍ**

- 3x ostřejší než čepel ocelová
- 10x delší životnost
- žáruvzdorná, nevodivá, nemagnetická



Č.p.	specifikace	
16131	18 mm	10
16066	náhradní čepel 18 mm, 5 ks	10

**FESTA**<sup>®</sup>

**NŮŽ ODLAMOVACÍ**



Č.p.	specifikace	
16110	L11 18 mm + 1 čepel	12

**FESTA**<sup>®</sup>

**NŮŽ ODLAMOVACÍ**



Č.p.	specifikace	
16100	L12 18 mm + 1 čepel	12

**FESTA**<sup>®</sup>

**NŮŽ ODLAMOVACÍ**



Č.p.	specifikace	
16105	L17 18 mm + 1 čepel	12

**FESTA**<sup>®</sup>

**NŮŽ ODLAMOVACÍ**



Č.p.	specifikace	
16125	L4 9 mm	24
16120	L8 18 mm	24

**FESTA**<sup>®</sup>

**NŮŽ ODLAMOVACÍ**



Č.p.	specifikace	
16115	L10 9 mm	24



**FESTA**  
NŮŽ ODLAMOVCÍ

Č.p.	specifikace	
16150	18 mm	24
16151	18 mm bez loga FESTA	20



**FESTA**  
NŮŽ ODLAMOVCÍ

Č.p.	specifikace	
16136	18 mm	12



**FESTA**  
NŮŽ ODLAMOVCÍ

Č.p.	specifikace	
16137	25 mm	12



**FESTA**  
NŮŽ ODLAMOVCÍ  
• protiskluzové pogumování

Č.p.	specifikace	
16090	18 mm	12



**FESTA**  
NŮŽ ODLAMOVCÍ  
• protiskluzové pogumování

Č.p.	specifikace	
16091	25 mm	6



**FESTA**  
NŮŽ ODLAMOVCÍ  
• protiskluzové pogumování

Č.p.	specifikace	
16145	L25 18 mm	12



**FESTA**  
NŮŽ ODLAMOVCÍ  
• protiskluzové pogumování

Č.p.	specifikace	
16144	L24 18 mm	12



NŮŽ ODLAMOVCÍ

Č.p.	specifikace	
16143	18 mm	12



NŮŽ ODLAMOVCÍ

Č.p.	specifikace	
16142	18 mm	12



NŮŽ ODLAMOVCÍ

Č.p.	specifikace	
16025	18 mm	12



**FESTA**  
NŮŽ ODLAMOVCÍ

Č.p.	specifikace	
16029	18 mm	25



**FESTA**  
NŮŽ ODLAMOVCÍ  
• protiskluzové pogumování

Č.p.	specifikace	
16146	18 mm	12



**FESTA**

**NŮŽ ODLAMOVACÍ**  
· protiskluzové pogumování



Č.p.	specifikace	
16147	25 mm	12



**FESTA**

**NŮŽ ODLAMOVACÍ**  
· protiskluzové pogumování



Č.p.	specifikace	
16130	L18 18 mm + 5 čepelek	12



**FESTA**

**NŮŽ ODLAMOVACÍ**  
· protiskluzové pogumování



Č.p.	specifikace	
16135	L20 25 mm + 5 čepelek	6



**FESTA**

**NŮŽ ODLAMOVACÍ**  
· protiskluzové pogumování



Č.p.	specifikace	
16140	L22 18 mm	12



**FESTA**

**NŮŽ ODLAMOVACÍ**  
· protiskluzové pogumování



Č.p.	specifikace	
16034	25 mm	12



**FESTA**

**NŮŽ ODLAMOVACÍ**



Č.p.	specifikace	
16085	9 mm	24



**FESTA**

**NŮŽ ODLAMOVACÍ**



Č.p.	specifikace	
16086	18 mm	24



**NŮŽ BEZPEČNOSTNÍ**

Č.p.	specifikace	
16044		20



**NŮŽ BEZPEČNOSTNÍ**  
· samozatahovací čepel

Č.p.	specifikace	
16057	135 mm	12



**FESTA**

**NŮŽ BEZPEČNOSTNÍ**



Č.p.	specifikace	
16058		6
16074	náhradní čepel 10 ks	1

16074



**NEW**



**FESTO**

NŮŽ ZAVÍRACÍ SE ŠKRABKOU

+2 SK4



Č.p.	specifikace	
16039		6
16087	náhradní čepele	1



**FESTO**

NŮŽ TURBO

+5 ALU



Č.p.	specifikace	
16037	+ 5 čepelek	6

**FESTO**

NŮŽ ZAVÍRACÍ

+5 ALU



Č.p.	specifikace	
16023	nůž zavírací + 5 čepelek	12
16071	náhradní čepel 10 ks	10

**FESTO**

NŮŽ ZAVÍRACÍ, SADA ČEPELÍ

ALU

Č.p.	specifikace	
16095	25 čepelek	1



SADA SKALPELŮ

22x



Č.p.	specifikace	
16282		24



SADA SKALPELŮ

13x



Č.p.	specifikace	
16281		10



**FESTO**

NŮŽ S ARETACÍ

· protiskluzové pogumování

ALU +2



Č.p.	specifikace	
16035	+ 2 čepeleky	12



**FESTO**

NŮŽ S ARETACÍ

ALU +3



Č.p.	specifikace	
16033	NP 110 + 3 čepeleky	5





NŮŽ S ARETACÍ

ALU



Č.p.	specifikace	
16032	NP 109	48



NŮŽ S ARETACÍ

ALU



Č.p.	specifikace	
16031	NS 107 B	24



NŮŽ

ALU

Č.p.	specifikace	
16030	NS 107	24



NŮŽ ODLAMOVCÍ

ALU



Č.p.	specifikace	
16046	18 mm	12



NŮŽ ODLAMOVCÍ

ALU



Č.p.	specifikace	
16028	S 201 18 mm	24



NŮŽ ODLAMOVCÍ

ALU

Č.p.	specifikace	
16026	P 205 18 mm	30



NŮŽ ODLAMOVCÍ

HOBBY



Č.p.	specifikace	
16021	P 201 9 mm	60



NŮŽ ODLAMOVCÍ

HOBBY



Č.p.	specifikace	
16024	P 204 18 mm	60



NŮŽ ODLAMOVCÍ

\* protiskluzové pogumování



Č.p.	specifikace	
16141	18 mm	24



SADA NOŽŮ

HOBBY 12x

Č.p.	specifikace	
16053	9 mm	12
16055	18 mm	12



SADA NOŽŮ

HOBBY 3x

Č.p.	specifikace	
16043		24





## NŮŽ NA PODLAHOVINY

na koberce a podlahové krytiny



Č.p.	specifikace	
16036	45 mm	12



## NŮŽ HÁKOVÝ

na koberce a podlahové krytiny



Č.p.	specifikace	
16041		12



50 mm

## ŠKRABKA

ALU



Č.p.	specifikace	
16059	50 mm	10
16082	břit náhradní	1



100 mm

## ŠKRABKA

pro použití s 18 mm čepelemi k odlamovacím nožům

ALU



Č.p.	specifikace	
16054	100 mm	1



100 mm

## ŠKRABKA



Č.p.	specifikace	
16052	48 cm délka	6
16070	čepel	25



38 mm

**FESTA**

## ŠKRABKA POGUMOVANÁ

protiskuzové pogumování



Č.p.	specifikace	
16049		12
16069	náhradní čepel	1



60 mm

## ŠKRABKA



Č.p.	specifikace	
16051		24



55 mm

## ŠKRABKA



Č.p.	specifikace	
16050		24



## SADA NA APLIKACI A ODSTRANĚNÍ SILIKONU

3x



Č.p.	specifikace	
16042		12





**FESTA**

## ČEPEL NÁHRADNÍ

- 7 segmentů
- 3x delší životnost
- dvojitý broušení
- nízký řezný odpor

**SK2 10x**



Č.p.	specifikace	
16064	25   0,7 mm	20



**FESTA**

## ČEPEL NÁHRADNÍ

- 8 segmentů
- 3x delší životnost
- dvojitý broušení
- nízký řezný odpor

**SK2 10x**



Č.p.	specifikace	
16062	18   0,7 mm	10



**FESTA**

## ČEPEL NÁHRADNÍ

- 15 segmentů
- 3x delší životnost
- dvojitý broušení
- nízký řezný odpor

**SK2 10x**



Č.p.	specifikace	
16063	18   0,7 mm	10



**FESTA**

## ČEPEL NÁHRADNÍ KERAMICKÁ

- 8 segmentů
- 3x ostřejší než čepel ocelová
- 10x delší životnost
- Záruvzdorná, nevodivá, nemagnetická

**5x**



Č.p.	specifikace	
16066	18   0,6 mm	10



## ČEPEL NÁHRADNÍ

- 8 segmentů
- dvojitý broušení

**10x**



Č.p.	specifikace	
16078	18   0,5 mm	25



## ČEPEL NÁHRADNÍ

- 8 segmentů
- dvojitý broušení

**10x**



Č.p.	specifikace	
16077	18   0,6 mm	25



## ČEPEL NÁHRADNÍ

- 7 segmentů

**10x**



Č.p.	specifikace	
16068	25   0,6 mm	20



## ČEPEL NÁHRADNÍ

- 8 segmentů

**10x**



Č.p.	specifikace	
16065	18   0,5 mm	60



## ČEPEL NÁHRADNÍ

- 15 segmentů

**10x**



Č.p.	specifikace	
16081	18   0,5 mm	60



## ČEPEL NÁHRADNÍ

- 4 segmenty

**10x**



Č.p.	specifikace	
16067	18   0,5 mm	10



## ČEPEL NÁHRADNÍ 30°

- 7 segmentů

**10x**



Č.p.	specifikace	
16061	9   0,4 mm	60



## ČEPEL NÁHRADNÍ

- 13 segmentů

**10x**



Č.p.	specifikace	
16060	9   0,45 mm	10



**FESTA**

## ČEPEL NÁHRADNÍ

**10x**



Č.p.	specifikace	
16072	R 004	10



**FESTA**

## ČEPEL NÁHRADNÍ

**10x**



Č.p.	specifikace	
16075	R 003	10



## ČEPEL NÁHRADNÍ

**10x**



Č.p.	specifikace	
16071	R 001	60

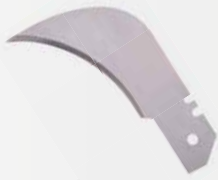

## ČEPEL NÁHRADNÍ

5x

Č.p.	specifikace	
16083	18 mm	50



## ČEPEL NÁHRADNÍ

10x

Č.p.	specifikace	
16073	R 002	60



## ČEPEL NÁHRADNÍ

5x

Č.p.	specifikace	
16084	18 mm	50

**FESTA**

## ČEPEL NÁHRADNÍ

· pro 16058

10x

Č.p.	specifikace	
16074		1



## ČEPEL NÁHRADNÍ

· pro 34315

Č.p.	specifikace	
34316		1



## ČEPEL NÁHRADNÍ NA ŠKRABKU

· pro 16052

Č.p.	specifikace	
16070	100 mm	25

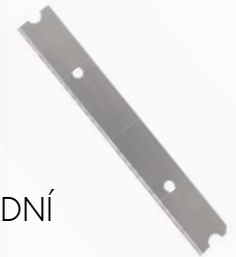

**FESTA**

## NŮŽ NA MINERÁLNÍ VATU

Č.p.	specifikace	
16198	44,5   33 cm	12



**FESTA**

## NŮŽ NA IZOLACE

· na minerální vatu, polystyren

Č.p.	specifikace	
16199	48   35 cm	10



**FESTA**

## MAČETA

Č.p.	specifikace	
45069	490 mm	6

TEFLON



**FESTA**

## MAČETA

Č.p.	specifikace	
44950	490 mm	4

TEFLON



## MAČETA NEREZ

Č.p.	specifikace	
45083	430 mm	12
45084	600 mm	6

INOX



## MAČETA

· rukojeť vyrobená z jasanového dřeva

Č.p.	specifikace	
45081	510 mm	36
45082	710 mm	36



**FESTA**

## NŮŽ LOVECKÝ

- nylonová rukojeť
- čepel s teflonovým povrchem
- pouzdro s pojistkou a klipem



<b>INOX</b>	<b>TEFLON</b>	<b>NYLON</b>	Č.p.	specifikace	
			16234	21   10 cm	10



**FESTA**

## NŮŽ LOVECKÝ



<b>INOX</b>	<b>TEFLON</b>	Č.p.	specifikace	
		16229	23   10 cm	12



**FESTA**

## DLÁTO TRUHLÁŘSKÉ MULTIFUNKČNÍ

- zesílená čepel



<b>INOX</b>	Č.p.	specifikace	
	16231	20   8 cm	12



## NŮŽ TECHNICKÝ

- zesílená čepel

<b>INOX</b>	Č.p.	specifikace	
	16230	21   10 cm	12



**FESTA**

## NŮŽ ZAHNUTÝ NA PODLAHOVINY

Č.p.	specifikace	
16225	20   8,5 cm	12



**FESTA**

## NŮŽ ELEKTRIKÁŘSKÝ

- zesílená čepel

<b>INOX</b>	Č.p.	specifikace	
	16212	15   3,2 cm	12



**FESTA**

## NŮŽ ODIZOLOVACÍ

Č.p.	specifikace	
16201	Ø 8 - 27 mm	10



**FESTA**

## NŮŽ ELEKTRIKÁŘSKÝ

<b>INOX</b>	Č.p.	specifikace	
	16211	20   8,5 cm	10



**FESTA**

## NŮŽ ELEKTRIKÁŘSKÝ

<b>INOX</b>	Č.p.	specifikace	
	16210	20,5   9 cm	10





**FESTA**

NŮŽ OČKOVACÍ



INOX	Č.p.	specifikace	24
	16219	19   11 cm	



**FESTA**

NŮŽ ROUBOVACÍ



INOX	Č.p.	specifikace	24
	16218	18,5   10,5 cm	



**FESTA**

NŮŽ ŠTĚPAŘSKÝ



INOX	Č.p.	specifikace	24
	16220	18,5   11 cm	



**FESTA**

NŮŽ ZAVÍRACÍ



INOX	Č.p.	specifikace	24
	16235	17,5   8,5 cm	



**FESTA**

NŮŽ ZAVÍRACÍ



INOX	Č.p.	specifikace	24
	16221	21   12 cm	



**FESTA**

NŮŽ ZAVÍRACÍ



INOX	Č.p.	specifikace	24
	16236	22,5   10 cm	



**FESTA**

NŮŽ ZAVÍRACÍ



INOX	Č.p.	specifikace	1
	16209	14,5   5,5 cm	



**FESTA**

NŮŽ ZAVÍRACÍ



INOX	Č.p.	specifikace	24
	16222	20   12 cm	



**FESTA**

NŮŽ ZAVÍRACÍ



INOX	ALU	Č.p.	specifikace	24
		16223	18,5   10,5 cm	

**FESTA****NŮŽ ZAVÍRACÍ MULTIFUNKČNÍ**

· 5 funkcí

**INOX**

Č.p.	specifikace
16228	27   10,5 cm



24

**FESTA****NŮŽ ZAVÍRACÍ MULTIFUNKČNÍ**

· 10 funkcí

**INOX**

Č.p.	specifikace
16226	17,5   7 cm



24

**NŮŽ ZAVÍRACÍ MULTIFUNKČNÍ**

· 7 funkcí

**INOX**

Č.p.	specifikace
16224	17,5   7 cm



24

**NŮŽ ZAVÍRACÍ LOVECKÝ**

· 3 funkce

**INOX**

Č.p.	specifikace
16227	20,5   10 cm



24

**FESTA****KLEŠTĚ MULTIFUNKČNÍ**

· 9 funkcí

· pouzdro

**CrV**

Č.p.	specifikace
16232	

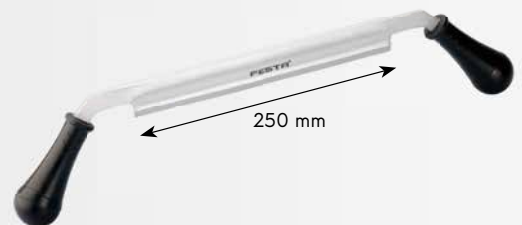

12

**NEW****FESTA****POŘÍZ****CrV**

Č.p.	specifikace
24132	250/490 mm



1

**HOBLÍK KLOPKAŘ**

Č.p.	specifikace
19510	220 x 65 x 130 mm, nůž 48 mm

1

**HOBLÍK HLADÍK**

Č.p.	specifikace
19515	200 x 55 x 130 mm, nůž 39 mm

1

**HOBLÍK ŘÍMSOVNÍK**

Č.p.	specifikace
19520	225 x 27 x 155 mm, nůž 27 mm

1



**FESTA**

DLÁTO

CrV

Č.p.	specifikace	
19490	6 mm   290 mm	6
19491	8 mm   290 mm	6
19492	10 mm   290 mm	6
19493	12 mm   290 mm	6
19494	14 mm   290 mm	6
19495	16 mm   290 mm	6

Č.p.	specifikace	
19496	18 mm   290 mm	6
19497	20 mm   290 mm	6
19498	22 mm   290 mm	6
19499	25 mm   290 mm	6
19501	32 mm   290 mm	6
19502	38 mm   290 mm	6



3 mm

**FESTA**

DLÁTO TRUHLÁŘSKÉ  
MULTIFUNKČNÍ

INOX

Č.p.	specifikace	
16231	20   80 mm	12



**FESTA**

SADA DLÁT S BROUSKEM

CrV

5x

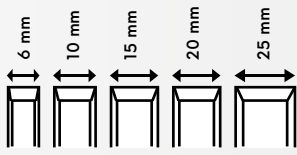

Č.p.	specifikace	
19451		10



**FESTA**

SADA DLÁT

CrV

4x

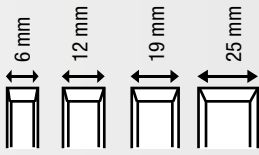

Č.p.	specifikace	
19457		10



SADA DLÁT

4x

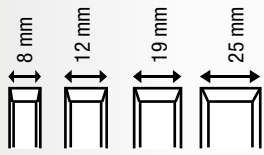

Č.p.	specifikace	
19455		30

**FESTA**



**FESTA**

SADA SOUSTRUŽNICKÝCH  
DLÁT

CrV

8x

Č.p.	specifikace	
19458	365   125mm	1



SADA DLÁT

4x

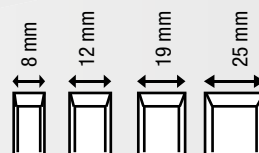

Č.p.	specifikace	
19450		20



SADA ŘEZBÁŘSKÝCH DLÁT

12x CrV

Č.p.	specifikace	
19459		5

**FESTA**

**BROUSEK MULTIFUNKČNÍ 15v1**



	30° Anvil	
	45° Anvil	
	50° Anvil	
	23° Bypass	
	35° Bypass	
	65° Bypass	
	Deburr Tool	



Č.p. Specifikace

45073



**BROUSEK OVÁLNÝ**

Č.p. specifikace 20

45370

250 x 33 x 18 mm

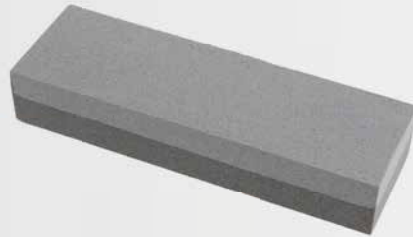

**BROUSEK**

Č.p. specifikace 1

45045

150 x 50 x 30 mm



**BROUSEK NA KOSU**

Č.p. specifikace 100

45046

205 x 15 mm



**BROUSEK NA NOŽE A NŮŽKY**

Č.p. specifikace 20

16991

specifikace



**BROUSEK NA NOŽE A NŮŽKY**

Č.p. specifikace 1

16990

Ø 50 mm



**BROUSEK NA NOŽE A NŮŽKY**

Č.p. specifikace 20

45048

specifikace



**BROUSEK NA NOŽE A NŮŽKY 6 V 1**

Č.p. specifikace 10

45068

specifikace





**FESTA**  
POWER X TOOLS

## POLYFÚZNÍ SVÁŘEČKA PLASTOVÝCH TRUBEK

- napětí / frekvence 230 V / 50 Hz
- příkon 750 / 1500 W
- teplota 0-300 C°
- nástavce Ø 20,25,32,40,50,63 mm
- váha 1,6 kg



• součást balení: metr, vodováha, šroubovák, inbus klíč, nůžky na trubky, 6x svařovací nástavec, stojánek, plechový kufr



Č.p.  
17182

1



**FESTA**  
POWER X TOOLS

## HROTOVÁ POLYFÚZNÍ SVÁŘEČKA PLASTOVÝCH TRUBEK

- napětí / frekvence 230 V / 50 Hz
- příkon 800 / 1000 W
- teplota 0-300 C°
- nástavce Ø 16, 20, 25, 32 mm
- váha 1 kg



• součást balení: inbus, 4x svařovací nástavec, stojánek, plechový kufr



Č.p.  
17183

1

**FESTA**

## KLEŠTĚ NA PVC TRUBKY

Ø max.  
42 mm



Č.p.

specifikace



17027

10

16315

náhradní čepel

1



## ČEPEL NÁHRADNÍ PRO KLEŠTĚ

• pro kleště 17027

Č.p.

specifikace



16315

1



**FESTA**



**FESTA**

## KLEŠTĚ NA PVC TRUBKY

Ø max.  
32 mm



Č.p.

specifikace

17037

12

## KLEŠTĚ NA PVC TRUBKY

Ø max.  
42 mm



Č.p.

specifikace

17026

6





**FESTA**

ŘEZAČ TRUBEK

INOX ALU

ALU Cu PVC



Č.p.	Specifikace	
16305	Ø 22 mm	10
16306	Ø 15 mm	10
16307 <b>NEW</b>	Ø 28 mm	10



**NEW**



**FESTA**

ŘEZAČ TRUBEK - SADA

Ø 15 mm  
Ø 22 mm  
Ø 28 mm

3x INOX ALU

ALU Cu PVC

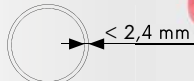

**NEW**

**FESTA**

ŘEZAČ PVC TRUBEK

PLASTIC INOX

PVC

Č.p.	Specifikace	
16308	Ø 20 - 50 mm	10

Č.p.	Specifikace	
16309		1



**FESTA**

ŘEZAČ  
TENKOSTĚNNÝCH  
TRUBEK

3-22  
mm



Č.p.	specifikace	10
16301		10
16311	náhradní kolečko	1

**FESTA**

ŘEZAČ  
TENKOSTĚNNÝCH  
TRUBEK

6-64  
mm



Č.p.	specifikace	6
16304		6
16312	náhradní kolečko	1

ŘEZAČ  
TENKOSTĚNNÝCH  
TRUBEK

3-32  
mm



Č.p.	specifikace	10
16303		10
16311	náhradní kolečko	1

ŘEZAČ  
TENKOSTĚNNÝCH  
TRUBEK

3-32  
mm



Č.p.	specifikace	10
16300		10
16310	náhradní kolečko	1

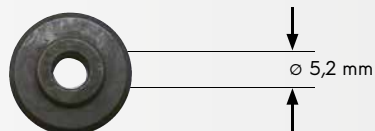

KOLEČKO NÁHRADNÍ  
PRO ŘEZAČE  
PVC TRUBEK



Č.p.	specifikace	1
16310	Ø 17,5 mm x 6 mm pro 16300	1
16311	Ø 18,0 mm x 4,5 mm pro 16303, 16301	1
16312	Ø 27,5 mm x 6 mm pro 16304	1



**FESTA**

NŮŽKY NA PVC LIŠTY  
A TRUBKY

· lišty, trubky, profily

5x Ø 17 mm Ø 20 mm Ø 27 mm

Č.p.	specifikace	8
17050	60   250 mm	8



**NEW**

**FESTA**

ODJEHLOVAČ  
NA TRUBKY

6-38  
mm ALU



Č.p.	specifikace	1
16319	Ø 6 - 38 mm	1



**FESTA**

ODJEHLOVAČ

1/4"



Č.p.	specifikace	5
16321		5

ODJEHLOVAČ  
NA TRUBKY

6-32  
mm



Č.p.	specifikace	1
16320		1

**FESTA**

ZÁHLUBNÍK  
RUČNÍ  
HSS

HSS Ø 25 mm 90°



Č.p.	specifikace	10
20360		10

ODJEHLOVAČ



Č.p.	specifikace	1
20361		1



## ŠROUBOVÁK PLOCHÝ

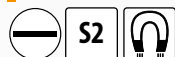

Č.p.	specifikace	
18113	3 x 75 mm	12
18114	4 x 100mm	12
18115	5,5 x 125 mm	12
18116	6,5 x 150 mm	12
18118	8 x 175 mm	6
18120	10 x 200 mm	6



## ŠROUBOVÁK PHILIPS

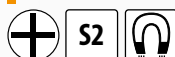

Č.p.	specifikace	
18210	0 x 75 mm	12
18211	1 x 75 mm	12
18212	2 x 100 mm	12



## ŠROUBOVÁK POZIDRIVE



Č.p.	specifikace	
18310	0 x 75 mm	12
18311	1 x 100 mm	12
18312	2 x 100 mm	12
18313	3 x 150 mm	6



## ŠROUBOVÁK TORX



Č.p.	specifikace	
18350	T6	12
18351	T7	12
18352	T8	12
18353	T9	12
18354	T10	12
18355	T15	12
18356	T20	12
18357	T25	12
18358	T27	12
18359	T30	12
18360	T40	6



## ŠROUBOVÁK PLOCHÝ KRÁTKÝ

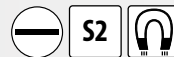

Č.p.	specifikace	
18124	5,5 x 38 mm	12
18125	6,5 x 38 mm	12



## ŠROUBOVÁK PHILIPS KRÁTKÝ

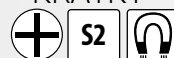

Č.p.	specifikace	
18215	1 x 38 mm	12
18216	2 x 38 mm	12



## ŠROUBOVÁK POZIDRIVE KRÁTKÝ

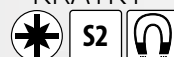

Č.p.	specifikace	
18321	1 x 38 mm	12
18322	2 x 38 mm	12



## ŠROUBOVÁK NA BITY + 7 BITŮ

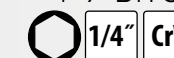

Č.p.	specifikace	
18425		10

- S 5 · 6 mm
- ⊕ PH 1 · 2 · 3
- ⊛ T 15 · 20

**NEW**



## SADA ŠROUBOVÁKŮ A BITŮ

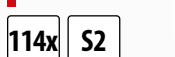

Č.p.	specifikace	
18434		1

- šroubovák na bity
- šroubovák na mini bity
- šroubováky
  - 3x75, 5x75, 5x100, 6x100, 6x150, 8x150
  - ⊕ 0x75, 1x75, 1x100, 2x100, 2x150
  - ⊛ T10x75, T15x75
  - VDE 2.5x75mm, 4.0x100mm
  - zkoušečka napětí
  - 2.5x40, 3.0x40mm
  - ⊕ 00x40mm, 0x40mm,
  - ⊛ T6x40mm, T7x40mm
- inbus
  - 1/16", 5/64", 3/32", 1/8", 5/32", 3/16", 7/32", 1/4"
  - 1.5, 2.0, 2.5, 3.0, 4.0, 5.0, 5.5, 6.0mm
- nástavce
  - 6mm, 7mm, 8mm, 9mm, 10mm, 11mm
- bity
  - SL 3mm, 4mm, 4.5mm, 5mm, 5.5mm, 6mm, 7mm, 8mm
  - ⊕ PH0, PH0, PH1, PH1, PH2, PH2, PH3, PH3
  - ⊛ PZ0, PZ0, PZ1, PZ1, PZ2, PZ2, PZ3, PZ3,
  - ⊛ T6, T8, T10, T15, T20, T25, T27, T30, T35, T40
  - H1.5, H2.5, H3.0, H3.5, H4.0, H4.5, H5.0, H5.5, H6, H8
  - S0, S1, S2, S3
- mini bity
  - SL 1.5mm, 2.0mm, 2.5mm, 3.0mm, 4.0mm
  - ⊕ PH000, PH00, PH0, PH1
  - ⊛ T4, T5, T6, T7, T8, T9, T10, T15, T20
  - H0.7, H0.9



## SADA ŠROUBOVÁKŮ

- ⊖ S 3x75 · 5x100 · 6,5x150 mm
- ⊕ PH 0 · 1 · 2 · 3



7x



Č.p. specifikace

18402

6



## SADA ŠROUBOVÁKŮ

- ⊖ S 3x75 · 5x100 · 6x150 mm
- ⊕ PH 0 · 1 · 2



6x



Č.p. specifikace

18403

6



## SADA ŠROUBOVÁKŮ

- ⊖ S 6,5x38 · 5,5x75 · 6,5x100 · 8x150 mm  
2,5x50 · 3x50 mm
- ⊕ PH 2x38 · 1x75 · 2x100 · 3x150 mm  
0x50 · 00x50 mm
- ⊛ T 5x50 · 6x50 · 7x50 · 8x50 · 9x50 · 10x50 mm



18x



Č.p. specifikace

18424

6



## SADA ŠROUBOVÁKŮ

- ⊖ S 3x75 · 5x100 · 6,5x150 mm
- ⊛ PZ 0 · 1 · 2



6x



Č.p. specifikace

18404

6



## SADA ŠROUBOVÁKŮ TORX

- ⊛ T 10 · 15 · 20 · 25 · 30



5x



Č.p. specifikace

18340

6



## SADA ŠROUBOVÁKŮ A BITŮ

- ⊖ S 3 x 75 · 4x100 · 5,5x125 · 6,5 x 150 mm
- ⊕ PH 1 x 100 · 2 x 100 mm
- ⊖ adapter 1/4"

bity:

- ⊖ S 4 · 5 · 6 · 7

- ⊕ PH 1 · 2 · 3

- ⊛ PZ 1 · 2 · 3

- ⊛ T 10 · 15 · 20 · 25 · 30

- H 2 · 3 · 4 · 5 · 6



27x



Č.p. specifikace

18422

27 ks

6



**FESTA**  
INDUSTRY

## VDE ŠROUBOVÁK ELEKTRO PLOCHÝ



Č.p.	specifikace		
18088	3 x 75 mm	S2	12
18089	4 x 100 mm	CrV	12
18090	5,5 x 125 mm	CrV	12
18091	6,5 x 150 mm	CrV	12
18092	8 x 175 mm	CrV	12



**FESTA**  
INDUSTRY

## VDE ŠROUBOVÁK ELEKTRO PHILIPS



Č.p.	specifikace		
18080	PH 0 x 60 mm	S2	12
18081	PH 1 x 80 mm	CrV	12
18082	PH 2 x 100 mm	CrV	12
18083	PH 3 x 150 mm	CrV	12



**FESTA**  
INDUSTRY

## SADA ELEKTRO ŠROUBOVÁKŮ

⊖ S 4x100 · 5,5x125 mm · elektro zkoušečka 0 - 250 V

⊕ PH 0x60 · 1x80 · 2x100 mm

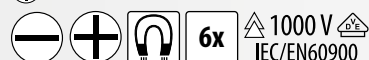

Č.p.	specifikace	
18413		6

**FESTA**  
INDUSTRY

## VDE ŠROUBOVÁK ELEKTRO POZIDRIVE



Č.p.	specifikace		
18084	PZ 0 x 60 mm	S2	12
18085	PZ 1 x 80 mm	CrV	12
18086	PZ 2 x 100 mm	CrV	12
18087	PZ 3 x 150 mm	CrV	12



**FESTA**

## ŠROUBOVÁK ÚDEROVÝ PLOCHÝ



Č.p.	specifikace	
18062	5,5 x 100 mm	12
18063	7 x 125 mm	6
18064	8 x 150 mm	8
18065	10 x 175 mm	6
18066	10 x 200 mm	6
18067	10 x 250 mm	6



**FESTA**

## SADA ELEKTRO ŠROUBOVÁKŮ

⊖ S 4x100 · 5,5x125 · 6,5x150 mm  
elektro zkoušečka 0 - 250 V

⊕ PH 0x75 · 1x100 · 2x100 mm

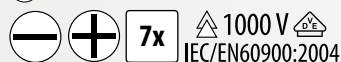

Č.p.	specifikace	
18410		40

**FESTA**

## ŠROUBOVÁK ÚDEROVÝ PHILIPS



Č.p.	specifikace	
18070	PH 1 x 80 mm	8
18071	PH 2 x 100 mm	12
18072	PH 3 x 150 mm	6



**FESTA**

## ŠROUBOVÁK ÚDEROVÝ POZIDRIVE



Č.p.	specifikace	
18075	PZ 1 x 80 mm	12
18076	PZ 2 x 100 mm	12
18077	PZ 3 x 150 mm	6



**FESTA**

## ŠROUBOVÁK ÚDEROVÝ

⊖ S 7 x 35 · 8 x 35 · 8 x 70 mm

⊕ PH 2 x 35 · 3 x 35 · 3 x 70 mm

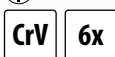

Č.p.	specifikace	
18411		1



**FESTA**

## SADA ÚDEROVÝCH ŠROUBOVÁKŮ

⊖ S 5 · 6 · 8 mm

⊕ PH 1 · 2 · 3



Č.p.	specifikace	
18423		10





## FESTA

### SADA ŠROUBOVÁKŮ A BITŮ

⊖ S 3x75 · 4x75 · 6x100 · 8x150 mm

⊕ PH 1x75 · 2x100 mm

○ adapter 1/4"

bity: ⊖ S 4 · 5 · 6 · 7 mm

⊕ PH 1 · 2 · 3

⊗ PZ 1 · 2 · 3

⊛ T 10 · 15 · 20

○ ↔ ⊠ adapter



Č.p. specifikace

18418



10



## FESTA

### SADA ŠROUBOVÁKŮ

⊖ S 3x60 · 4x75 · 6x100 · 6x125 mm

⊕ PH 0x60 · 1x75 · 2x100 mm



Č.p. specifikace

18400



10



## FESTA

### SADA ŠROUBOVÁKŮ

⊖ S 3x60 · 6x100 · 6x125 mm

⊕ PH 1x75 · 2x100 mm



Č.p. specifikace

18401



1

## FESTA

### ŠROUBOVÁK PLOCHÝ



Č.p.	specifikace	
18101	3 x 75 mm	10
18102	4 x 100 mm	10
18103	5,5 x 100 mm	10
18104	5,5 x 125 mm	10
18105	6,5 x 100 mm	10
18106	6,5 x 125 mm	10
18107	8 x 160 mm	10
18108	10 x 160 mm	10

## FESTA

### ŠROUBOVÁK PHILIPS



Č.p.	specifikace	
18201	0 x 75 mm	10
18202	1 x 75 mm	10
18203	2 x 100 mm	10
18204	3 x 150 mm	10

## FESTA

### ŠROUBOVÁK POZIDRIVE



Č.p.	specifikace	
18301	0 x 75 mm	10
18302	1 x 75 mm	10
18303	2 x 100 mm	10
18304	3 x 150 mm	10

## FESTA

### ŠROUBOVÁK NA BITY



Č.p.	specifikace	
18110		12



## FESTA

### NÁSTRČNÝ ŠROUBOVÁK

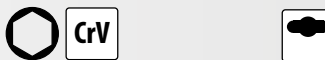

Č.p.	specifikace	
18455	6 mm	12
18456	7 mm	12
18460	13 mm	12



## FESTA

### FLEXI ŠROUBOVÁK NA BITY

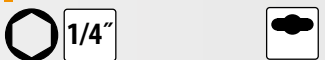

Č.p.	specifikace	
18451		12



## FESTA

### FLEXI ŠROUBOVÁK NA HADICOVÉ SPONY

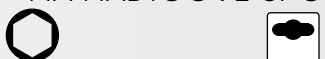

Č.p.	specifikace	
18450	7 mm	6





ŠROUBOVÁK  
NA BITY  
S RÁČNOU

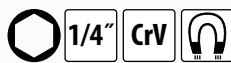

Č.p. specifikace  
18433 6



T ŠROUBOVÁK  
NA BITY  
S RÁČNOU

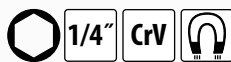

Č.p. specifikace  
18608 6



T ŠROUBOVÁK  
+ 20 NÁSTAVCŮ

- ⊖ S 3 · 4 · 5 · 6 · 8 mm
- ⊕ PH 0 · 1 · 2 · 3
- adapter + 5 · 6 · 7 · 8 · 9 · 10 · 11 · 12 · 13 mm



Č.p. specifikace  
18420 5



ŠROUBOVÁK S MINI BITY

- ⊖ S 1.5 · 2 · 2.5 · 3 · 3.5 mm
- ⊕ PH 000 · 00 · 0 · 1
- ⊗ PZ 0 · 1
- ⊛ T 5 · 6 · 7 · 8 · 9 · 10 · 15 · 20
- H 0.9 · 1.3 · 2.0 · 2.5 · 3.0 · 4.0



Č.p. specifikace  
18431 6



ŠROUBOVÁK RÁČNOVÝ  
S BITY

- 1/4" ⊖ ↔ ⊕ 1/4"
- ⊖ S 3 · 4 · 5 · 6 · 7 · 5 L
  - ⊕ PH 1 · 2 · 3 · 1 L · 2 L
  - ⊗ PZ 1 · 2 · 3 · 1 L · 2 L
  - H 2 · 2.5 · 3 · 4 · 5 · 6
  - ⊛ T 10 · 15 · 20 · 25 · 27 · 30
  - ⊞ SQ 0 · 1 · 2 · 3
  - 1/4" 5 · 6 · 7 · 8 · 9 · 10 · 11 · 12 · 13 mm



Č.p. specifikace  
18419 6



SADA MINI ŠROUBOVÁKŮ

- ⊖ S 1,5x50 · 2x50 · 2,5x50 mm
- ⊕ PH 000x50 · 00x50 · 0x50 mm



Č.p. specifikace  
18416 6



SADA MINI ŠROUBOVÁKŮ  
TORX

- ⊛ T 4 · 5 · 6 · 7 · 8 · 9 · 10x50 mm



Č.p. specifikace  
18417 6



SADA MINI  
ELEKTRO ŠROUBOVÁKŮ

- ⊖ S 2,4 · 3,0 mm
- ⊕ PH 0 · 1
- ⊛ T 6 · 8

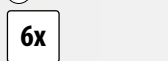

Č.p. specifikace  
18415 10

**FESTA**



**NEW**



**FESTA**

**ELEKTRO ZKOUŠEČKA**

· AC - 110 V, 250 V



Č.p. Specifikace

18427

24

**ELEKTRO ZKOUŠEČKA**

DIN VDE 0680  
73/23 EEC



Č.p. specifikace

18426 0 - 250 V



1

**FESTA**

**OTVÍRÁK**

Č.p. specifikace

18437



5

**ŠROUBOVÁKY HODINÁŘSKÉ**

⊖ S 1,4 · 2,0 · 2,4 · 3,0 mm

⊕ PH 0 · 1



**6x HOBBY**



Č.p. specifikace

18408

10



**ÚHLOVÝ NÁSTAVEC  
NA BITY 90°**



Č.p.

18910



25



**RÁČNA NA BITY**

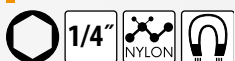

Č.p. specifikace

18435 93 mm



1



**ŠROUBOVÁKY HODINÁŘSKÉ**

⊖ S 1,0 · 1,2 · 1,4 · 1,8 · 2,4 · 3,0 mm

⊕ PH 00 · 0 · 1

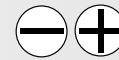

**11x HOBBY**



Č.p. specifikace

18409

48





## BIT TORZNÍ PH - 50 MM

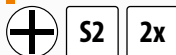

Č.p.	specifikace	
18715	PH1 x 50 mm	1
18716	PH2 x 50 mm	1
18717	PH3 x 50 mm	1



## BIT TORZNÍ PZ - 50 MM



Č.p.	specifikace	
18710	PZ1 x 50 mm	1
18711	PZ2 x 50 mm	1
18712	PZ3 x 50 mm	1



## BIT TORZNÍ T - 50 MM

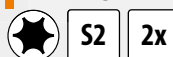

Č.p.	specifikace	
18720	T10 x 50 mm	1
18721	T15 x 50 mm	1
18722	T20 x 50 mm	1
18723	T25 x 50 mm	1
18724	T30 x 50 mm	1
18725	T40 x 50 mm	1



## BIT TORZNÍ - SADA

- ⊕ PH 2 · 2
- ⊕ PZ 2
- ⊕ T 15 · 15 · 20 · 20 · 25 · 30 · 40

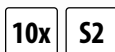

Č.p.	specifikace	
18432		1



bity - profesionální šroubovací nástavce z vysoce legované oceli S2

## Technologie výroby

křížové a ploché šroubovací nástavce jsou vyráběny speciální technologií přesného kování. Ta umožňuje dosažení vysoké přesnosti tvaru a současně zvýšení pevnosti oproti obráběným bitům až o 20 %. Po kování jsou bity kaleny pro získání optimální tvrdosti a houževnatosti.

### TiN vrstva

vrstva nitridu titanu nanášená na povrch šroubovacího hrotu maximálně zvyšuje tvrdost povrchu, otěruvzdornost a třecí vlastnosti zabraňující vysmeknutí ze záběru.

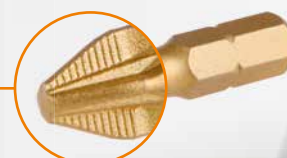

### Diamantová zrna

na povrchu hrotu se doslova „zakousnou“ do hlavy vrtu či šroubu a udrží bit v záběru pro přenos maximálního utahovacího momentu. Jsou nejlepší zárukou setrvání v záběru. Nejčastěji se šroubovací bit totiž poškodí při vysmeknutí ze záběru. Kroučící moment se v tu chvíli přenáší na minimální plochu, která se deformuje.



### Protismykové drážky

na pracovních plochách šroubovacích hrotů vyrobených kováním jsou další velmi účinnou obranou proti vysmeknutí hrotu ze záběru.





## BIT PH

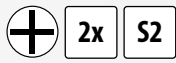

Č.p.	specifikace	
18632A	PH2 x 25 mm	1
18633A	PH3 x 25 mm	1



## BIT PZ

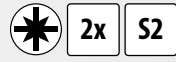

Č.p.	specifikace	
18636A	PZ1 x 25 mm	1
18637A	PZ2 x 25 mm	1
18638A	PZ3 x 25 mm	1



## BIT T

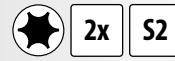

Č.p.	specifikace	
18827A	T20 x 25 mm	1
18828A	T25 x 25 mm	1
18830A	T30 x 25 mm	1
18831A	T40 x 25 mm	1



## BIT PH DIAMANT



Č.p.	specifikace	
18770	PH1 x 25 mm	5
18771	PH2 x 25 mm	5
18772	PH3 x 25 mm	5



## BIT PZ DIAMANT



Č.p.	specifikace	
18775	PZ1 x 25 mm	5
18776	PZ2 x 25 mm	5
18777	PZ3 x 25 mm	5



## BIT S

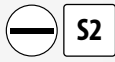

Č.p.	specifikace	
18620	S 3 x 25 mm	5
18621	S 4 x 25 mm	5
18623	S 5 x 25 mm	5
18625	S 6 x 25 mm	5
18627	S 7 x 25 mm	5
18628	S 8 x 25 mm	5



## BIT PH



Č.p.	specifikace	
18630	PH0 x 25 mm	5
18631	PH1 x 25 mm	5
18632	PH2 x 25 mm	5
18633	PH3 x 25 mm	5
18634	PH4 x 25 mm	5



## BIT PZ



Č.p.	specifikace	
18635	PZ0 x 25 mm	5
18636	PZ1 x 25 mm	5
18637	PZ2 x 25 mm	5
18638	PZ3 x 25 mm	5
18639	PZ4 x 25 mm	5



## BIT PH



Č.p.	specifikace	
18685	PH2 x 25 mm	25



## BIT PZ



Č.p.	specifikace	
18680	PZ2 x 25 mm	25



## BIT PH



Č.p.	specifikace	
18640	PH1 x 70 mm	10
18641	PH2 x 70 mm	10



## BIT PZ



Č.p.	specifikace	
18645	PZ1 x 70 mm	10
18646	PZ2 x 70 mm	10



## BIT PH

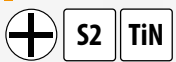

Č.p.	specifikace	
18760	PH0 x 25 mm	5
18761	PH1 x 25 mm	5
18762	PH2 x 25 mm	5
18763	PH3 x 25 mm	5
18764	PH4 x 25 mm	1



## BIT PZ

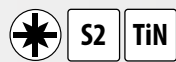

Č.p.	specifikace	
18765	PZ0 x 25 mm	5
18766	PZ1 x 25 mm	5
18767	PZ2 x 25 mm	5
18768	PZ3 x 25 mm	5
18769	PZ4 x 25 mm	5



## BIT S

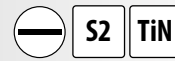

Č.p.	specifikace	
18750	S 3 x 25 mm	5
18751	S 4 x 25 mm	5
18753	S 5 x 25 mm	5
18755	S 6 x 25 mm	5



## BIT H



MOQ 5



Č.p.	specifikace	
18800	H 1,5 x 25 mm	5
18801	H 2,0 x 25 mm	5
18802	H 2,5 x 25 mm	5
18803	H 3,0 x 25 mm	5
18804	H 4,0 x 25 mm	5
18805	H 5,0 x 25 mm	5
18806	H 5,5 x 25 mm	5
18807	H 6,0 x 25 mm	5



## BIT TTA



MOQ 5



Č.p.	specifikace	
18835	TTa 5 x 25 mm	10
18836	TTa 6 x 25 mm	5
18837	TTa 7 x 25 mm	5
18838	TTa 8 x 25 mm	5
18839	TTa 9 x 25 mm	5
18840	TTa 10 x 25 mm	5
18841	TTa 15 x 25 mm	5
18842	TTa 20 x 25 mm	5
18843	TTa 25 x 25 mm	5
18844	TTa 27 x 25 mm	5
18845	TTa 30 x 25 mm	5
18846	TTa 40 x 25 mm	5
18847	TTa 45 x 25 mm	5



## BIT T



MOQ 5



Č.p.	specifikace	
18820	T5 x 25 mm	5
18821	T6 x 25 mm	5
18822	T7 x 25 mm	5
18823	T8 x 25 mm	5
18824	T9 x 25 mm	5
18825	T10 x 25 mm	5
18826	T15 x 25 mm	5
18827	T20 x 25 mm	5
18828	T25 x 25 mm	5
18829	T27 x 25 mm	5
18830	T30 x 25 mm	5
18831	T40 x 25 mm	5
18832	T45 x 25 mm	5



## BIT HTA



MOQ 5



Č.p.	specifikace	
18810	HTa 1,5 x 25 mm	5
18811	HTa 2,0 x 25 mm	5
18812	HTa 2,5 x 25 mm	5
18813	HTa 3,0 x 25 mm	5
18814	HTa 4,0 x 25 mm	5
18815	HTa 5,0 x 25 mm	5
18816	HTa 5,5 x 25 mm	5
18817	HTa 6,0 x 25 mm	5



## BIT SQ



MOQ 5



Č.p.	specifikace	
18850	SQ 0 x 25 mm	5
18851	SQ 1 x 25 mm	5
18852	SQ 2 x 25 mm	5
18853	SQ 3 x 25 mm	5



## BIT T



MOQ 3



Č.p.	specifikace	
17980	T30 x 35 mm	3
17981	T40 x 35 mm	3
17982	T45 x 35 mm	3
17983	T50 x 35 mm	3



## BIT SD



MOQ 5



Č.p.	specifikace	
18855	SD 6 x 25 mm	5
18856	SD 8 x 25 mm	5



## BIT T



MOQ 3



Č.p.	specifikace	
17970	T20 x 75 mm	3
17971	T25 x 75 mm	3
17972	T30 x 75 mm	3
17973	T40 x 75 mm	3

Č.p.	specifikace	
17974	T45 x 75 mm	3
17975	T50 x 75 mm	3
17976	T55 x 75 mm	3



## BIT TS



MOQ 5



Č.p.	specifikace	
18864	TS 4 x 25 mm	5
18865	TS 6 x 25 mm	5



## BIT



MOQ 5



Č.p.	specifikace	
18866	5/32 x 25 mm	5
18867	3/16 x 25 mm	5



## BIT TW



MOQ 5



Č.p.	specifikace	
18860	TW 1 x 25 mm	5
18861	TW 2 x 25 mm	5
18862	TW 3 x 25 mm	5
18863	TW 4 x 25 mm	5



## BIT XZN



MOQ 5



Č.p.	specifikace	
18870	M4 x 25 mm	5
18871	M5 x 25 mm	5
18872	M6 x 25 mm	5
18873	M8 x 25 mm	5
18874	M10 x 25 mm	5



## BIT

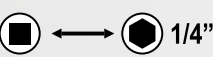

MOQ 5



Č.p.	specifikace	
18868	25 mm	5



## BIT

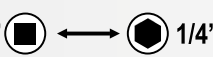
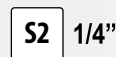

MOQ 5



Č.p.	specifikace	
18869	50 mm	5



**FESTA**

BIT  
NA SÁDROKARTON



Č.p.	specifikace	
18795	PH 2 x 25 mm	24



**FESTA**

BIT  
NA SÁDROKARTON



Č.p.	specifikace	
18796	PH 2 x 55 mm	24



**FESTA**  
INDUSTRY

ADAPTER  
RÁČNA 1/4" - BIT

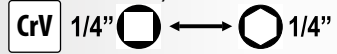

MOQ  
5



Č.p.	specifikace	
18619		5



**FESTA**  
INDUSTRY

NÁSTAVEC  
NA BITY



MOQ  
5



Č.p.	specifikace	
18600	1/4" x 60 mm	5



**FESTA**  
INDUSTRY

NÁSTAVEC  
NA BITY

· rychloupínací

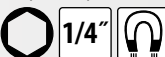

MOQ  
5



Č.p.	specifikace	
18601	1/4" x 60 mm	5



**FESTA**  
INDUSTRY

NÁSTAVEC  
NA BITY

· s dorazem



MOQ  
5



Č.p.	specifikace	
18602	1/4" x 60 mm	5



**FESTA**  
INDUSTRY

NÁSTAVEC  
NA BITY



Č.p.	specifikace	
18797	1/4" x 60 mm	1



**FESTA**  
INDUSTRY

NÁSTAVEC  
NA BITY

· rychloupínací

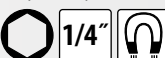

Č.p.	specifikace	
18798	1/4" x 60 mm	1



**FESTA**  
INDUSTRY

NÁSTAVEC  
NA BITY

· s dorazem



Č.p.	specifikace	
18799	1/4" x 60 mm	1



**FESTA**  
INDUSTRY

NÁSTAVEC  
NA BITY



Č.p.	specifikace	
18605	150 mm	25



**FESTA**

ADAPTÉR SDS+ NA BIT 1/4"



Č.p.	specifikace	
20743	75 mm	1



NÁSTAVEC NA BITY  
VODICÍ



Č.p.	specifikace	
18607	80 mm	25

**FESTA**

## NÁSTAVEC KLOUBOVÝ NA BITY



Č.p.	Specifikace	
18609	90mm	25

**NEW**

**WEST BERG**

## ADAPTÉR BIT 1/4" NA SDS +

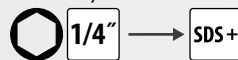

Č.p.	Specifikace	
20742		1

**NEW**

**FESTA INDUSTRY**

## SADA BITŮ A ADAPTÉRŮ

- 10x ⊕ 18630 PH0
- 10x ⊕ 18631 PH1
- 10x ⊕ 18632 PH2
- 10x ⊕ 18633 PH3
- 10x ⊕ 18635 PZ0
- 10x ⊕ 18636 PZ1
- 10x ⊕ 18637 PZ2
- 10x ⊕ 18638 PZ3
- 10x ⊕ 18761 PH1 TiN
- 10x ⊕ 18762 PH2 TiN
- 10x ⊕ 18763 PH3 TiN
- 10x ⊕ 18766 PZ1 TiN
- 10x ⊕ 18767 PZ2 TiN
- 10x ⊕ 18768 PZ3 TiN
- 10x ⊕ 18770 PH1 DIAMANT
- 10x ⊕ 18771 PH2 DIAMANT
- 10x ⊕ 18775 PZ1 DIAMANT
- 10x ⊕ 18776 PZ2 DIAMANT
- 10x ⊙ 18814 4,0HTa
- 10x ⊙ 18815 5,0HTa
- 10x ⊕ 18842 20TTa
- 10x ⊕ 18845 30TTa
- 10x ⊕ 18795 PH2 na sádrokarton
- 5x 18612 adapter 1/4" 8mm
- 5x 18613 adapter 1/4" 10mm
- 5x 18600 nástavec magnetický 1/4" 60mm
- 5x 18601 nástavec magnetický, rychloupínací 1/4" 60mm
- 5x 18602 nástavec magnetický, s dorazem 1/4" 65mm

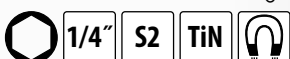

Č.p.	specifikace	
18993		1

**FESTA INDUSTRY**

## SADA BITŮ

- 10x ⊕ 18631 PH1
- 10x ⊕ 18632 PH2
- 10x ⊕ 18633 PH3
- 10x ⊕ 18636 PZ1
- 10x ⊕ 18637 PZ2
- 10x ⊕ 18638 PZ3
- 10x ⊕ 18761 PH1 TiN
- 10x ⊕ 18762 PH2 TiN
- 10x ⊕ 18763 PH3 TiN
- 10x ⊕ 18766 PZ1 TiN
- 10x ⊕ 18767 PZ2 TiN
- 10x ⊕ 18768 PZ3 TiN
- 10x ⊙ 18804 H 4
- 10x ⊙ 18805 H 5
- 10x ⊙ 18825 T 10
- 10x ⊙ 18826 T 15
- 10x ⊙ 18827 T 20
- 10x ⊙ 18828 T 25
- 10x ⊙ 18830 T 30
- 10x ⊙ 18831 T 40

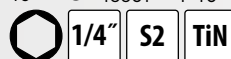

Č.p.	specifikace	
18994		1

**FESTA INDUSTRY**

## ADAPTER

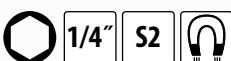

Č.p.	specifikace	
18610	6 mm	5
18611	7 mm	5
18612	8 mm	5



Č.p.	specifikace	
18613	10 mm	5
18614	12 mm	5
18615	13 mm	5

**FESTA INDUSTRY**

## ADAPTER



Č.p.	specifikace	
18610A	6 mm	5
18611A	7 mm	5
18612A	8 mm	5



Č.p.	specifikace	
18613A	10 mm	5
18614A	12 mm	5
18615A	13 mm	5

**FESTA**

## ADAPTER SADA

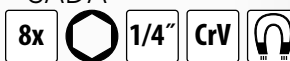

Č.p.	specifikace	
18618	6, 7, 8, 9, 10, 11, 12, 13 mm	12





## FESTA

### SADA BITŮ

- bity 25 mm
- ⊖ S 3 · 4 · 5 · 6
  - ⊕ PH 0 · 1 · 2 · 3
  - ✱ PZ 0 · 1 · 2 · 3
  - H 3 · 4 · 5 · 6
  - ★ T 10 · 15 · 20 · 25 · 27 · 30 · 40
  - ⊗ TTa 10 · 15 · 20 · 25 · 27 · 30 · 40

nástavec na bity



32x CrV



Č.p. specifikace  
18908

1



## FESTA

### SADA BITŮ

- ⊖ S 3 · 4 · 5 · 6
- ⊕ PH 1 · 2 · 3
- ✱ PZ 1 · 2 · 3
- H 3 · 4 · 5 · 6
- ★ T 10 · 15 · 20 · 25 · 27 · 30 · 40
- ⊗ TTa 10 · 15 · 20 · 25 · 27 · 30 · 40

magnetický rychloupínací nástavec na bity

33x 1/4" S2

Č.p. specifikace  
18905



10



## FESTA

### SADA BITŮ

- ⊖ S 4 · 5 · 6
- ⊕ PH 1 · 2 · 3
- ✱ PZ 1 · 2 · 3
- H 3 · 4 · 5 · 6
- ★ T 10 · 15 · 20 · 25 · 27 · 30 · 40
- ⊗ TTa 10 · 15 · 20 · 25 · 27 · 30 · 40

magnetický rychloupínací nástavec na bity

57x 1/4" S2

Č.p. specifikace  
18906



6

## FESTA

### SADA BITŮ

- ⊗ HTa 2 · 2.5 · 3 · 4 · 5 · 6  
5/32" · 9/64" · 1/8"  
7/64" · 3/32" · 5/64"
- ⊖ SD 4 · 6 · 8 · 10
- ✱ TS 6 · 8 · 10
- ⊖ TW 1 · 2 · 3 · 4
- ⊗ TTa 8 · 10 · 15 · 20 · 25 · 27 · 30 · 35 · 40

magnetický nástavec na bity

33x 1/4" S2



Č.p. specifikace  
18900

10

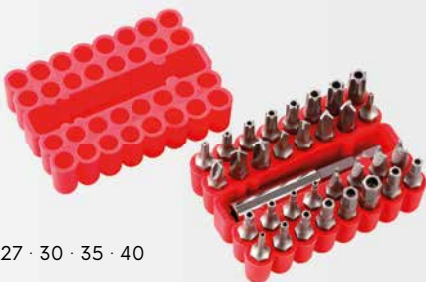

## FESTA

### SADA BITŮ

- ⊖ S 3 · 4 · 4.5 · 5 · 5.5 · 6 · 6.5 · 7 · 8
- ⊕ PH 0 · 1 · 2 · 3
- ✱ PZ 0 · 1 · 2 · 3
- ⊖ SQ 0 · 1 · 2 · 3
- ★ T 8 · 10 · 15 · 20 · 25 · 27 · 30 · 40 · 45
- ⊗ TTa 8 · 10 · 15 · 20 · 25 · 27 · 30 · 35 · 40
- H 1.5 · 2 · 2.5 · 3 · 4 · 5 · 5.5 · 6 · 8 mm  
1/16" · 5/64" · 3/32" · 7/64" · 1/8" · 9/64"  
5/32" · 3/16" · 7/32" · 1/4"
- ⊗ HTa 2 · 2.5 · 3 · 4 · 5 · 6 mm  
5/64" · 3/32" · 7/64" · 1/8" · 9/64" · 5/32"
- ⊖ SD 4 · 6 · 8 · 10
- ✱ TS 6 · 8 · 10
- ⊖ TW 1 · 2 · 3 · 4
- ⊖ 2-wing 1 · 2 · 3
- XZN 5 · 6 · 8

magnetický nástavec na bity nástavec „Y“

1/4" DR nástavec na šroubovák  
1/4" bit adapter: 25mm, 50mm

100x 1/4" S2

Č.p. specifikace  
18909



24



## FESTA

### SADA BITŮ

- ⊖ S 3 · 4 · 5 · 6 · 7
- ⊕ PH 0 · 1 · 2 · 3
- ✱ PZ 1 · 2 · 3
- H 2 · 2.5 · 3 · 4 · 5 · 6
- ★ T 10 · 15 · 20 · 25 · 30 · 40

magnetický nástavec na bity

33x 1/4" S2



Č.p. specifikace  
18901

10



## SADA BITŮ

- ⊖ S 4 · 5 · 6 · 7
- ⊕ PH 1 · 2 · 3
- ✱ PZ 1 · 2 · 3
- H 4 · 5 · 6
- ⊛ T 10 · 15 · 20 · 25
- SQ 1 · 2 · 3

20x S2



## SADA BITŮ

- ⊖ S 4 · 5 · 6 · 7
- ⊕ PH 1 · 2 · 3
- ✱ PZ 1 · 2 · 3

10x CrV TiN



## SADA BITŮ

- ⊖ S 3 · 5 · 7
  - ⊕ PH 1 · 2 · 3
- magnetický nástavec na bity

7x HOBBY



Č.p. specifikace 18907 10

Č.p. specifikace 18440 10

Č.p. specifikace 18430 20



## SADA BITŮ A NÁSTAVCŮ

- ⊖ S 3 · 3,5 · 4 · 5,5
- ⊕ PH 0 · 1 · 2 · 3
- ✱ PZ 0 · 1 · 2 · 3
- H 3 · 4
- ⊛ T 10 · 15 · 20 · 25 · 27 · 30
- 1/4" 4 · 4,5 · 5 · 5,5 · 6 · 7 · 8 · 9 · 10 · 11 · 13

nástavec na šroubovák 1/4"  
magnetický nástavec na bity

CrV 1/4"

40x



Č.p. specifikace 18915 10

## SADA NÁŘADÍ

- ⊖ S 5 · 6 mm
- ⊕ PH 1 · 2
- H 3 · 4 · 5 · 6
- ⊛ T 15 · 20 · 25 · 30
- 1/4" 4 · 5 · 6 · 7 · 8 · 9 · 10 · 12 · 13 mm

75 mm 1/4" 1/4" ↔ 1/4"

1/4" CrV

23x



Č.p. specifikace 18421 10



# FESTA

10 years  
guarantee



CrV  
STEEL



Cr-Mo

## GOLA SADY

- použití v průmyslu a servisech
- vysoce kvalitní Chrom vanadiová ocel
- ráčna se 72 vybrušenými zuby pro tu nejpřesnější práci
- všechny komponenty dle DIN normy
- vroubkované hlavice pro zlepšení úchopu
- odolný kufr s kovovými zámky a kovovými panty



FESTA

## GOLA SADA

- 1/2", 1/4", 3/8"
- 1/4" · 4-5-6-7-8-9-10mm
- 3/8" · 10-11-12-13-14-15mm
- 1/2" · 16-17-18-19-22mm
- 1/4" · 4-4.5-5-5.5-6-7-8-9-10-11-12-13-14mm
- 3/8" · 10-11-12-13-14-15-16-17-18-19mm
- 1/2" · 10-11-12-13-14-15-16-17-18-19-20-21-22-24-27-30-32mm
- 1/4" · E4-E5-E6-E7-E8
- 3/8" · E10-E11-E12-E14-E16-E18
- 1/2" · E20-E24
- 1/2" · 24x
- 1/4" · 20x
- 1/4" · 30x
- 1/4" · 50 mm, 100 mm
- 1/2" · 125 mm, 250 mm
- 3/8" · 150 mm
- 1/2" · 16-21mm
- 3/8" · 18mm
- 1/2", 1/4", 3/8" bit holder
- 1/2", 1/4", 3/8"
- 1/4" · 150mm
- 1/4" · 115mm
- Inbus 7X



10 years  
guarantee



CrV S2 1/4" 1/2" 3/8" 72T 171x ERGO HANDLE

Č.p. 17237 specifikace

2



**FESTA**

## GOLA SADA

- 1/2" · 72T
- 1/2" · 125 mm
- 1/2" · 10-11-12-13-14-15-17-19-22-24 mm

10 years guarantee



Č.p. specifikace  
17245 15



**FESTA**

## GOLA SADA

- 1/2" · 72T
- 1/2" · 125 mm
- 1/2" · 10-11-12-13-14-15-17-19-22-24 mm

10 years guarantee



Č.p. specifikace  
17229 8



**FESTA**

## GOLA SADA

- 1/2" · 72 T
- 1/2" · 75, 125 mm
- 1/2"
- 1/2" · 10-11-12-13-14-15-16-17-18-19-22-24 mm
- 1/2" · 17mm, 19mm
- 3-cestný adaptér
- 16mm, 21mm

10 years guarantee



Č.p. specifikace  
17230 4



**FESTA**

## GOLA SADA

- 1/4" · 72 T
- 1/4" · 50, 100 mm
- 1/4"
- 1/4" · 4-5-5,5-6-7-8-10-11-12-13 mm
- 1/4" · 6-7-8-10-12-13 mm
- 3-cestný adaptér
- 4 x
- 11x
- 1x

10 years guarantee



Č.p. specifikace  
17231 10



**FESTA**

## GOLA SADA

- 1/4"
- 1/4"
- 1/4" · 4-4,5-5-5,5-6-7-8-9-10-11-12-13-14 mm
- 1/4" · 50 mm, 100 mm
- 1/4"
- 1/4"
- 21 x
- 1/4"
- L 1/4"

10 years guarantee



Č.p. specifikace  
17233 10



**FESTA**

## GOLA SADA

- 1/2", 1/4" · 72T
- 1/4"
- 16 mm, 21 mm
- 1/4" · 10-11-12-13-14-15-16-17-18-19-20-21-22-23-24-27 mm
- 1/4" · 100 mm
- 1/2" · 125 mm, 250 mm
- 1/2"
- 1x
- 1/4" · 4-5-5,5-6-7-8-10-11-12-13 mm
- 33 x



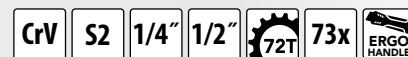







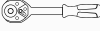





10 years guarantee



Č.p. specifikace  
17234 4

**FESTA**

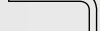
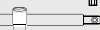
**GOLA SADA**

-  1/2", 1/4" · 72T
-  1/4"
-  16 mm, 21 mm
-  1/4" · 4 -4,5-5-5,5-6-7-8-9-10-11-12-13-14 mm
-  1/2" · 10-11-12-13-14-15-16-17-18-19-20-21-22-23-24-27-30-32 mm
-  1/4" · 6-7-8-9-10-11-12-13 mm
-  1/2" · 14-15-17-19 mm
-  1/4" · 50 mm, 100 mm
-  1/2" · 125 mm, 250 mm
-  1/4"
-  5/16" nástavec na bity
-  17x
-  15x
-  3-cestný adaptér
-  3 x
-  1/4"
-  L 1/4"
-  1/2", 1/4"

CrV S2 1/4" 1/2" 72T 94x ERGO HANDLE













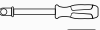





10 years guarantee



Č.p.	specifikace
17235	4

**FESTA**

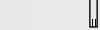
**GOLA SADA**

-  1/2", 1/4" · 72T
-  150 mm
-  16 mm, 21 mm
-  1/4" · 4 -4,5-5-5,5-6-7-8-9-10-11-12-13-14 mm
-  1/2" · 10-11-12-13-14-15-16-17-18-19-20-21-22-24-27-30-32 mm
-  1/4" · 6-7-8-9-10-11-12-13 mm
-  1/2" · 14-15-17-19-22 mm
-  1/4" · 50 mm, 100 mm
-  1/2" · 125 mm, 250 mm
-  E · 4-5-6-7-8-10-11-12-14-16-18-20-24-27-30-32 mm
-  1/2", 1/4"
-  5/16" nástavec na bity
-  18 x
-  17 x
-  3-cestný adaptér
-  4 x
-  1/4"
-  L 1/4"

CrV S2 1/4" 1/2" 72T 110x ERGO HANDLE













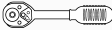





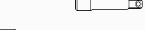

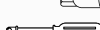





10 years guarantee

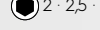

Č.p.	specifikace
17236	4

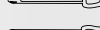
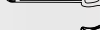
**FESTA**

**SADA NÁŘADÍ**

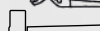
-  1/2", 1/4"
-  1/4" · 4-5-6-7-8-9mm
-  1/2" · 10-12-13-14-17-19mm
-  1/4" · 4-4,5-5-5,5-6-7-8-9-10-11-12-13-14mm
-  1/2" · 12-13-14-15-16-17-18-19-20-21-22-24mm
-  1/2", 1/4"
-  1/4" · 150mm
-  1/2" · 254mm
-  1/2", 1/4"
-  1/2" · 16-21mm
-  1/4" · 150mm
-  1/2" · E10-E12-E14-E16-E18-E20-E22-E24
-  1/4" · S 3 · 4 · 5 · 6
-  1/4" · PH 0 · 1 · 2
-  1/4" · PZ 0 · 1 · 2
-  1/4" · S 4 · 5,5 · 6,5
-  1/4" · PH 1 · 2 · 3
-  1/4" · PZ 2 · 3
-  1/4" · H 3 · 4 · 5 · 6
-  1/4" · T 8 · 10 · 15 · 20 · 25
-  1/4" · TTα 10 · 15 · 20 · 25 · 40
-  2 · 2,5 · 3 · 4 · 5 · 6 · 7 · 8 · 10mm
-  8-9-10-11-12-13-14-15-16-17-18-19mm
-  S 4x100 · 6,5x150
-  PH 2x100 · 3x150
-  180mm
-  160mm
-  160mm
-  250mm
-  300g

CrV S2 1/4" 1/2" 72T 122x ERGO HANDLE



Č.p.	specifikace
17238	122 ks 1



**FESTA**



**FESTA****RÁČNY FESTA**

- ráčny jsou vyrobeny z nejkvalitnější Chrom vanadiové oceli
- ráčny se 72 vybroušenými zuby pro tu nejpřesnější práci
- kvalitní, ergonomické, dvoukomponentní rukojeti z měkčené TPE gumy
- SYSTÉM QUICK RELEASE pro snadnou a rychlou výměnu hlavice

**FESTA****RÁČNA**

Č.p.	specifikace	délka	
17297	1/4"	155 mm	6
17298	3/8"	210 mm	5
17299	1/2"	255 mm	4

**FESTA****RÁČNA**

Č.p.	specifikace	délka	
17240	1/4"	155 mm	10
17241	3/8"	200 mm	10
17242	1/2"	250 mm	5

**FESTA****RÁČNA**

Č.p.	specifikace	délka	
17294	1/4"	155 mm	6
17295	3/8"	205 mm	10
17296	1/2"	255 mm	4

**FESTA****RÁČNA  
OTOČNÁ 1/4"**

Č.p.	specifikace	
17292	1/4"	1

**RÁČNA****HOBBY**

Č.p.	specifikace	
17243	1/4" 43T	25
17244	1/2" 39T	25

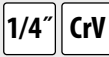
**FESTA****ŠROUBOVÁK  
NA HLAVICE**

Č.p.	specifikace	
18603	1/4" 150 mm	10



## FESTA

### HLAVICE 1/4"



Č.p.	specifikace	
17820	4 mm • 25 mm	10
17821	4,5 mm • 25 mm	10
17822	5 mm • 25 mm	10
17823	5,5 mm • 25 mm	10
17824	6 mm • 25 mm	10
17825	7 mm • 25 mm	10
17826	8 mm • 25 mm	10
17827	9 mm • 25 mm	10
17828	10 mm • 25 mm	10
17829	11 mm • 25 mm	10
17830	12 mm • 25 mm	10
17831	13 mm • 25 mm	10
17832	14 mm • 25 mm	10



## FESTA

### HLAVICE 1/2"



Č.p.	specifikace	
17308	8 mm • 38 mm	10
17309	9 mm • 38 mm	10
17310	10 mm • 38 mm	10
17311	11 mm • 38 mm	10
17312	12 mm • 38 mm	10
17313	13 mm • 38 mm	10
17314	14 mm • 38 mm	10
17315	15 mm • 38 mm	10
17316	16 mm • 38 mm	10
17317	17 mm • 38 mm	10
17318	18 mm • 38 mm	10
17319	19 mm • 38 mm	10
17320	20 mm • 38 mm	10
17321	21 mm • 38 mm	10
17322	22 mm • 38 mm	10
17324	24 mm • 38 mm	10
17327	27 mm • 42 mm	20
17330	30 mm • 42 mm	25
17332	32 mm • 42 mm	20
17333	34 mm • 42 mm	20
17334	36 mm • 42 mm	20



## FESTA

### HLAVICE 3/4"



Č.p.	specifikace	
17835	17 mm • 48 mm	10
17836	18 mm • 48 mm	10
17837	19 mm • 48 mm	10
17838	21 mm • 48 mm	10
17839	22 mm • 48 mm	10
17840	24 mm • 48 mm	10
17841	26 mm • 48 mm	10
17842	27 mm • 52 mm	10
17843	28 mm • 52 mm	10
17844	30 mm • 52 mm	10
17845	32 mm • 52 mm	10
17846	33 mm • 55 mm	10
17847	36 mm • 60 mm	10
17848	38 mm • 60 mm	10
17849	41 mm • 65 mm	10
17850	46 mm • 65 mm	10
17851	50 mm • 70 mm	10
17852	55 mm • 75 mm	10
17853	60 mm • 78 mm	10
17854	65 mm • 82 mm	10
17855	70 mm • 82 mm	10
17856	75 mm • 88 mm	10



## FESTA

### HLAVICE MULTILOCK 1/2"



Č.p.	specifikace	
17910	8 mm • 38 mm	10
17914	12 mm • 38 mm	10
17916	14 mm • 38 mm	10
17922	21 mm • 38 mm	10
17924	24 mm • 38 mm	10
17926	30 mm • 38 mm	10



## FESTA

### HLAVICE PRODLOUŽENÁ 1/4"



Č.p.	specifikace	
17860	4 mm • 50 mm	10
17861	5 mm • 50 mm	10
17862	6 mm • 50 mm	10
17863	7 mm • 50 mm	10
17864	8 mm • 50 mm	10
17865	9 mm • 50 mm	10
17866	10 mm • 50 mm	10
17867	11 mm • 50 mm	10
17868	12 mm • 50 mm	10
17869	13 mm • 50 mm	10
17870	14 mm • 50 mm	10



## FESTA

### HLAVICE PRODLOUŽENÁ 1/2"



Č.p.	specifikace	
17871	10 mm • 70 mm	10
17872	11 mm • 70 mm	10
17873	12 mm • 70 mm	10
17874	13 mm • 70 mm	10
17875	14 mm • 70 mm	10
17876	15 mm • 70 mm	10
17877	16 mm • 70 mm	10
17878	17 mm • 70 mm	10
17879	18 mm • 70 mm	10
17880	19 mm • 70 mm	10
17881	20 mm • 70 mm	10
17882	21 mm • 70 mm	10
17883	22 mm • 70 mm	10
17884	23 mm • 70 mm	10
17885	24 mm • 70 mm	10
17886	25 mm • 70 mm	10
17887	26 mm • 70 mm	10
17888	27 mm • 70 mm	10
17889	28 mm • 70 mm	10
17890	30 mm • 70 mm	10
17891	32 mm • 70 mm	10
17892	34 mm • 70 mm	10



## FESTA

### HLAVICE TORX 1/2"



Č.p.	specifikace	
17943	E22	10
17944	E24	10



## FESTA

### HLAVICE TORX 1/4"



Č.p.	specifikace	
17930	E4	10
17934	E8	10
17935	E10	10



## FESTA

### HLAVICE MULTILOCK 1/4"



Č.p.	specifikace	
17895	4 mm • 25 mm	10
17896	4,5 mm • 25 mm	10
17897	5 mm • 25 mm	10
17898	5,5 mm • 25 mm	10
17904	11 mm • 25 mm	10
17905	12 mm • 25 mm	10
17907	14 mm • 25 mm	10





**FESTA**

NÁSTAVEC ŠROUBOVACÍ 1/4"

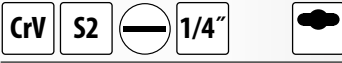

Č.p.	specifikace	
18920	S 4 mm	10
18921	S 5,5 mm	10
18922	S 7 mm	10



**FESTA**

NÁSTAVEC ŠROUBOVACÍ 1/4"



Č.p.	specifikace	
18925	PH 1	10
18926	PH 2	10
18927	PH 3	10



**FESTA**

NÁSTAVEC ŠROUBOVACÍ 1/4"



Č.p.	specifikace	
18928	PZ 0	10
18929	PZ 1	10
18930	PZ 2	10
18931	PZ 3	10



**FESTA**

NÁSTAVEC ŠROUBOVACÍ 1/2"



Č.p.	specifikace	
18954	T 10	10
18955	T 15	10
18956	T 20	10
18960	T 40	10
18961	T 45	10
18963	T 55	10



**FESTA**

NÁSTAVEC ŠROUBOVACÍ 1/4"



Č.p.	specifikace	
18948	T 5	10
18950	T 8	10
18951	T 10	10



**FESTA**

NÁSTAVEC ŠROUBOVACÍ 1/4"



Č.p.	specifikace	
18934	3 mm	10
18939	8 mm	10



**FESTA**

NÁSTAVEC ŠROUBOVACÍ 1/2"



Č.p.	specifikace	
18971	M 16	10



**FESTA**

JEZDEC NA „T“ VRATIDLO

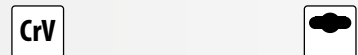

Č.p.	specifikace	
17420	1/4"	1
17421	1/2"	1
17422	3/4"	1



**FESTA**

ADAPTÉR



Č.p.	specifikace	
17410	A - 1/4" B - 3/8"	10
17411	A - 3/8" B - 1/4"	10
17412	A - 3/8" B - 1/2"	10
17413	A - 1/2" B - 3/8"	10
17414	A - 1/2" B - 3/4"	10
17415	A - 3/4" B - 1/2"	10
17416	A - 1/4" B - 1/2"	10



**FESTA**

NÁSTAVEC PRODLUŽOVACÍ

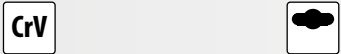

Č.p.	specifikace	
17390	1/4" • 50 mm	1
17391	1/4" • 100 mm	1
17392	1/4" • 150 mm	1
17393	1/2" • 75 mm	1
17394	1/2" • 125 mm	1
17395	1/2" • 250 mm	1
17396	3/4" • 100 mm	1
17397	3/4" • 200 mm	1
17398	3/4" • 400 mm	1



**FESTA**

KARDAN

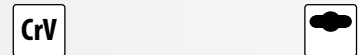

Č.p.	specifikace	
17405	1/4" • 39 mm	10
17406	1/2" • 71 mm	10
17407	3/4" • 105 mm	10

**FESTA**

„T“ VRATIDLO



Č.p.	specifikace	
17382	1/4" • 115 mm	1
17383	3/8" • 190 mm	1
17384	1/2" • 250 mm	1
17385	3/4" • 460 mm	1
17386	1" • 640 mm	1



**FESTA**

„T“ NÁSTAVEC PRODLOUŽENÝ S KLOUBEM

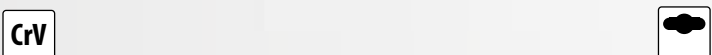

Č.p.	specifikace	
17401	1/4" • 250 mm	1
17402	1/2" • 400 mm	1





**FESTA**

VRATIDLO KLOUBOVÉ  
TRHÁK

CrV

Č.p.	specifikace	
17380	1/2" • 350 mm	1
17381	3/4" • 500 mm	1



**FESTA**

RUKOJEŤ OHNUTÁ

CrV 1/2"

Č.p.	specifikace	
17427	1/2" • 60 x 320 mm	1



**FESTA**

NÁSTAVEC FLEXIBILNÍ

CrV 1/4"

Č.p.	specifikace	
17400	1/4" • 150 mm	1

**Stahlberg**

ADAPTÉR  
RÁČNA 1/4" - BIT

CrV

1/4" ↔ 1/4"

Č.p.	specifikace	
18619		5



MOQ  
5



HLAVICE  
UNIVERZÁLNÍ

CrV 1/2"

Č.p.	Specifikace	
17812	10 - 19 mm	1



HLAVICE UNIVERZÁLNÍ

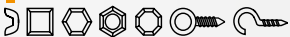

CrV 3/8"

Č.p.	specifikace	
17810	pro šrouby 7 - 19mm • 52mm x ø26mm	1

1/4"



3/8"



HLAVICE UNIVERZÁLNÍ

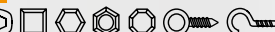

CrV 1/2"

Č.p.	specifikace	
17811	pro šrouby 11 - 32mm • 83mm x ø43mm	5

1/4"



1/2"



SADA NÁSTRČNÝCH HLAVIC DRIVELOCK

4-5-5,5-6-7-8-9-10-11-12-13 mm

CrV 1/4" 12x

Č.p.	specifikace	
17250		10



SADA NÁSTRČNÝCH HLAVIC TORX

1/4" • 5-6-7-8-10  
1/2" • 12-14-16-18

CrV 1/2" 1/4" 9x

Č.p.	specifikace	
17255		4



SADA ADAPTÉRŮ  
DO VRTAČKY

CrV 1/4" 3x

Č.p.	specifikace	
18604	1/4", 3/8", 1/2"	10

**FESTA**

KLÍČ  
NA RADIÁTOROVÉ ŠROUBENÍ

CrV 1/2"

Č.p.	specifikace	
17455	pro ráčnu 1/2"	10



**NEW**



**FESTA**

**SADA T KLÍČŮ INBUS + TORX**

- H 2.5 · 3 · 4 · 5 · 6 · 8 · 10 mm
- ★ T 10 · 15 · 20 · 25 · 30 · 40 · 45

**14x CrV**



Č.p.	Specifikace
18501	

1

**FESTA**

**NÁSTRČNÝ T - KLÍČ INBUS SADA**

- 2 mm
- 2,5 mm
- 3 mm
- 4 mm
- 5 mm
- 6 mm
- 7 mm
- 8 mm
- 10 mm

**9x** **CrV**

Č.p.	specifikace
18494	



6



**FESTA**

**KLÍČ NÁSTRČNÝ T - TORX**

**★ CrV**



Č.p.	specifikace
17350	T 7 10
17351	T 8 10
17352	T 9 10
17353	T 10 10

Č.p.	specifikace
17357	T 27 10
17359	T 40 10
17361	T 50 10

**FESTA**

**NÁSTRČNÝ T - KLÍČ TORX SADA**

- T 10
- T 15
- T 20
- T 25
- T 27
- T 30
- T 40
- T 45
- T 50

**9x** **CrV**

Č.p.	specifikace
18495	



6



**FESTA**

**KLÍČ INBUS - STANDARD**

**DIN 911** **CrV**

Č.p.	specifikace
18567	27 mm 100 x 250 mm 1
18572	32 mm 125 x 315 mm 1



**FESTA**

**KLÍČ INBUS PRODLOUŽENÝ**

**CrV**

Č.p.	specifikace
18510	1,5 mm 14 x 74 mm 1
18511	2 mm 16 x 81 mm 1
18512	2,5 mm 18 x 88 mm 1
18513	3 mm 23 x 108 mm 1
18514	4 mm 24 x 107 mm 1
18515	5 mm 23 x 118 mm 1
18516	6 mm 32 x 135 mm 1
18518	8 mm 36 x 153 mm 1
18519	9 mm 38 x 155 mm 1
18520	10 mm 40 x 168 mm 1
18521	11 mm 40 x 230 mm 1
18522	12 mm 45 x 237 mm 1
18523	13 mm 45 x 260 mm 1
18524	14 mm 55 x 265 mm 1
18527	17 mm 60 x 298 mm 1



**FESTA**

**KLÍČ INBUS S HLAVIČKOU PRODLOUŽENÝ**

**CrV**

Č.p.	specifikace
18575	1,5 mm 15 x 75 mm 1
18576	2 mm 17 x 81 mm 1
18577	2,5 mm 18 x 87 mm 1
18578	3 mm 20 x 96 mm 1
18579	4 mm 24 x 107 mm 1
18580	5 mm 30 x 120 mm 1
18581	6 mm 33 x 136 mm 1
18582	7 mm 34 x 144 mm 1
18583	8 mm 36 x 153 mm 1
18584	9 mm 38 x 155 mm 1
18585	10 mm 40 x 168 mm 1
18587	12 mm 45 x 237 mm 1
18588	13 mm 45 x 210 mm 1
18589	14 mm 55 x 265 mm 1
18593	17 mm 60 x 298 mm 1



**FESTA**

**KLÍČ TORX**

**★ CrV**

Č.p.	specifikace
18476	T45 1



## FESTA

### SADA INBUSŮ

H 1,5 mm  
H 2 mm  
H 2,5 mm  
H 3 mm  
H 4 mm  
H 5 mm  
H 6 mm  
H 8 mm  
H 10 mm



Č.p. specifikace  
18496



## FESTA

### SADA INBUSŮ S HLAVIČKOU

H 1,5 mm  
H 2 mm  
H 2,5 mm  
H 3 mm  
H 4 mm  
H 5 mm  
H 6 mm  
H 8 mm  
H 10 mm



Č.p. specifikace  
18500



## FESTA

### SADA INBUSŮ PRODLOUŽENÉ

H 1,5 mm  
H 2 mm  
H 2,5 mm  
H 3 mm  
H 4 mm  
H 5 mm  
H 6 mm  
H 8 mm  
H 10 mm



Č.p. specifikace  
18490



## FESTA

### SADA INBUSŮ S HLAVIČKOU

H 1,5 mm  
H 2 mm  
H 2,5 mm  
H 3 mm  
H 4 mm  
H 5 mm  
H 6 mm  
H 8 mm  
H 10 mm



Č.p. specifikace  
18498



## FESTA

### SADA INBUSŮ S HLAVIČKOU

1/16"  
5/64"  
3/32"  
1/8"  
5/32"  
3/16"  
1/4"  
5/16"  
3/8"

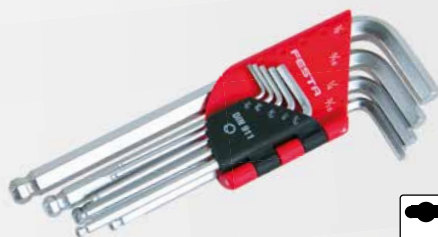

Č.p. specifikace  
18493



## FESTA

### SADA KLÍČŮ TORX

T 10 mm  
T 15 mm  
T 20 mm  
T 25 mm  
T 27 mm  
T 30 mm  
T 40 mm  
T 45 mm  
T 50 mm



Č.p. specifikace  
18497



## FESTA

### SADA INBUSŮ S HLAVIČKOU PRODLOUŽENÉ

H 1,5 mm  
H 2 mm  
H 2,5 mm  
H 3 mm  
H 4 mm  
H 5 mm  
H 6 mm  
H 8 mm  
H 10 mm



Č.p. specifikace  
18492



## FESTA

### SADA KLÍČŮ TORX PRODLOUŽENÉ

T 10 mm  
T 15 mm  
T 20 mm  
T 25 mm  
T 27 mm  
T 30 mm  
T 40 mm  
T 45 mm  
T 50 mm



Č.p. specifikace  
18491



## FESTA

### SADA INBUSŮ



Č.p. specifikace  
18508 1,5 · 2 · 2,5 · 3 · 4 · 5 · 6 mm



### SADA INBUSŮ



Č.p. specifikace  
18499 2 · 2,5 · 3 · 4 · 5 · 6 · 8 · 10 mm



**FESTA**KLÍČ OBOUSTRANNÝ  
OTEVŘENÝ

CrV DIN 3110



Č.p.	specifikace	
17550	6 x 7 mm	10
17551	8 x 9 mm	10
17552	8 x 10 mm	10
17553	10 x 11 mm	10
17590	10 x 13 mm	10
17554	12 x 13 mm	10
17555	14 x 15 mm	10
17556	13 x 16 mm	10
17557	13 x 17 mm	10
17591	14 x 17 mm	10
17558	16 x 17 mm	10
17559	17 x 19 mm	10
17560	18 x 19 mm	10

Č.p.	specifikace	
17592	19 x 22 mm	10
17593	19 x 24 mm	10
17561	20 x 22 mm	10
17569	21 x 23 mm	10
17548	22 x 24 mm	10
17562	24 x 27 mm	10
17549	24 x 30 mm	10
17563	30 x 32 mm	10
17564	30 x 34 mm	10
17565	32 x 36 mm	10
17566	36 x 41 mm	10
17567	46 x 50 mm	10
17568	50 x 55 mm	3

**FESTA**KLÍČ  
OČKOPLOCHÝ

CrV DIN 3113



Č.p.	specifikace	
17487	6 mm	10
17570	7 mm	10
17571	8 mm	10
17572	9 mm	10
17573	10 mm	10
17574	11 mm	10
17575	12 mm	10
17576	13 mm	10
17577	14 mm	10
17578	15 mm	10
17579	16 mm	10
17580	17 mm	10
17581	18 mm	10
17582	19 mm	10
17488	20 mm	10

Č.p.	specifikace	
17489	21 mm	10
17583	22 mm	10
17490	23 mm	10
17584	24 mm	10
17491	25 mm	10
17492	26 mm	10
17585	27 mm	10
17493	28 mm	10
17494	29 mm	10
17586	30 mm	10
17587	32 mm	10
17495	33 mm	10
17496	34 mm	10
17589	36 mm	10

**FESTA**KLÍČ RÁČNOVÝ  
KLOUBOVÝ

CrV 72T



Č.p.	specifikace	
17628	8 mm	10
17622	10 mm	10
17623	13 mm	10
17624	14 mm	10
17629	15 mm	10
17630	16 mm	5

Č.p.	specifikace	
17625	17 mm	10
17631	18 mm	10
17626	19 mm	10
17632	21 mm	5
17633	22 mm	5

**FESTA**KLÍČ  
RÁČNOVÝ

CrV 72T



Č.p.	specifikace	
17660	6 mm	10
17676	7 mm	10
17661	8 mm	10
17662	9 mm	10
17663	10 mm	10
17664	11 mm	10
17665	12 mm	10
17666	13 mm	10
17667	14 mm	10
17668	15 mm	10

Č.p.	specifikace	
17669	16 mm	10
17670	17 mm	10
17671	18 mm	10
17672	19 mm	10
17674	21 mm	5
17675	22 mm	5
17677	24 mm	5
17678	27 mm	5
17679	30 mm	5
17683	32 mm	5

**FESTA**KLÍČ OBOUSTRANNÝ  
OTEVŘENÝ

DIN 895



Č.p.	specifikace	
17460	6 x 7 mm	10
17461	8 x 9 mm	10
17462	8 x 10 mm	10
17463	10 x 11 mm	10
17481	10 x 13 mm	10
17464	12 x 13 mm	10
17465	14 x 15 mm	10
17467	13 x 17 mm	10
17482	14 x 17 mm	10
17468	16 x 17 mm	10

Č.p.	specifikace	
17469	17 x 19 mm	10
17470	18 x 19 mm	10
17483	19 x 22 mm	10
17484	19 x 24 mm	10
17471	20 x 22 mm	10
17472	24 x 27 mm	10
17486	21 x 23 mm	10
17480	28 x 30 mm	10
17473	30 x 32 mm	10
17485	36 x 41 mm	10

**FESTA**KLÍČ OČKOVÝ  
VYHNUTÝ

CrV DIN 838



Č.p.	specifikace	
17605	6 x 7 mm	10
17606	8 x 9 mm	10
17607	8 x 10 mm	10
17608	10 x 11 mm	10
17609	12 x 13 mm	10
17611	13 x 16 mm	10
17612	13 x 17 mm	10

Č.p.	specifikace	
17610	14 x 15 mm	10
17613	16 x 17 mm	10
17614	18 x 19 mm	10
17615	20 x 22 mm	10
17616	24 x 27 mm	10
17617	30 x 32 mm	10

**FESTA**KLÍČ OBOUSTRANNÝ  
OTEVŘENÝ

CrV DIN 3110



Č.p.	specifikace	
17761	14 x 15 mm	10
17769	20 x 22 mm	10

**FESTA**KLÍČ  
OČKOPLOCHÝ

CrV DIN 3113



Č.p.	specifikace	
17788	14 mm	10
17795	21 mm	10
17806	33 mm	10

**FESTA**

**KLÍČ RÁČNOVÝ S VLOŽKAMI**

8-9-10-11-12-13-14-15-16-17-18-19 mm



Č.p. 17619

specifikace

1



**FESTA**

**KLÍČ UNIVERZÁLNÍ**

**Cr-Mo**



12-13-14-15 mm

16-17-18-19 mm

Č.p. 17685

specifikace

12-13-14-15-16-17-18-19 mm

1



**FESTA**

**KLÍČ STAVITELNÝ**

**CrV**



**KLÍČ STAVITELNÝ**

Č.p.	rozsah	délka	
17197	0 - 29 mm	200 mm	1
17198	0 - 33 mm	250 mm	1
17199	0 - 38 mm	300 mm	1

Č.p.	rozsah	délka	
17200	0 - 24 mm	200 mm	6
17201	0 - 30 mm	250 mm	6
17202	0 - 34 mm	300 mm	6



**FESTA**



**FESTA**

**KLÍČ OBOUSTRANNÝ OTEVŘENÝ - SADA**

**CrV**

**DIN 3110**



Č.p.	specifikace	
17506	6 ks · 6 x 7, 8 x 9, 10 x 11, 12 x 13, 14 x 15, 16 x 17	1
17508	8 ks · 6 x 7, 8 x 9, 10 x 11, 12 x 13, 14 x 15, 16 x 17, 18 x 19, 20 x 22	1



**FESTA**

**KLÍČ OČKOPLOCHÝ - SADA**

**CrV**

**DIN 3113**



Č.p.	specifikace	
17526	6 ks · 10 x 10, 11 x 11, 13 x 13, 14 x 14, 16 x 16, 17 x 17	1
17528	8 ks · 8 x 8, 10 x 10, 11 x 11, 13 x 13, 14 x 14, 16 x 16, 17 x 17, 19 x 19	1



**FESTA**

**KLÍČ OČKOVÝ VYHNUTÝ - SADA**

**8x**

**CrV**

**DIN 838**



Č.p.	specifikace	
17539	6 x 7, 8 x 9, 10 x 11, 12 x 13, 14 x 15, 16 x 17, 18 x 19, 20 x 22	1



**FESTA**

**KLÍČ OČKOPLOCHÝ - SADA**

CrV

DIN 3113



Č.p.	specifikace	
17532	12 ks · 8 x 8, 9 x 9, 10 x 10, 11 x 11, 13 x 13, 14 x 14, 16 x 16, 17 x 17, 18 x 18, 19 x 19, 21 x 21, 22 x 22	10
17533	18 ks · 6 x 6, 7 x 7, 8 x 8, 9 x 9, 10 x 10, 11 x 11, 12 x 12, 13 x 13, 14 x 14, 15 x 15, 16 x 16, 17 x 17, 18 x 18, 19 x 19, 20 x 20, 21 x 21, 22 x 22, 24 x 24	1
17534	25 ks · 6 x 6, 7 x 7, 8 x 8, 9 x 9, 10 x 10, 11 x 11, 12 x 12, 13 x 13, 14 x 14, 15 x 15, 16 x 16, 17 x 17, 18 x 18, 19 x 19, 20 x 20, 21 x 21, 22 x 22, 23 x 23, 24 x 24, 25 x 25, 26 x 26, 27 x 27, 28 x 28, 30 x 30, 32 x 32	4

**FESTA**

**KLÍČ RÁČNOVÝ - SADA**

CrV



7x



Č.p.	specifikace	
17620	8, 10, 12, 13, 14, 17, 19	5

**FESTA**

**KLÍČ RÁČNOVÝ, KLOUBOVÝ - SADA**

CrV



7x



Č.p.	specifikace	
17621	10, 12, 13, 14, 15, 17, 19	5

**FESTA**

**KLÍČ OBOUSTRANNÝ OTEVŘENÝ - SADA**

CrV

DIN 3110

12x



Č.p.	specifikace	
17512	6 x 7, 8 x 9, 10 x 11, 12 x 13, 14 x 15, 16 x 17, 18 x 19, 20 x 22, 21 x 23, 24 x 27, 25 x 28, 30 x 32	1

**FESTA**

**KLÍČ TRUBKOVÝ - SADA**

CrV

7x



Č.p.	specifikace	
17501	6 x 7, 8 x 9, 10 x 11, 12 x 13, 14 x 15, 16 x 17, 18 x 19	20
17640	páka na trubkové klíče · 135 mm	50

**FESTA**

**KLÍČ OTEVŘENÝ - SADA DIN 895**

DIN 895



Č.p.	specifikace	
17475	8 ks · 6 x 7, 8 x 9, 10 x 11, 12 x 13, 14 x 15, 16 x 17, 18 x 19, 20 x 22	5
17476	12 ks · 6 x 7, 8 x 9, 10 x 11, 12 x 13, 14 x 15, 16 x 17, 18 x 19, 20 x 22, 21 x 23, 24 x 27, 28 x 30, 30 x 32	3

**FESTA**

**KLÍČ TRUBKOVÝ**

CrV

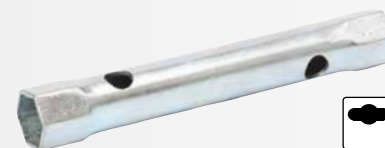

Č.p.	specifikace		Č.p.	specifikace	
17650	6 x 7 mm	10	17655	16 x 17 mm	10
17651	8 x 9 mm	10	17645	16 x 18 mm	10
17642	8 x 10 mm	10	17653	16 x 21 mm	10
17652	10 x 11 mm	10	17656	18 x 19 mm	10
17643	12 x 13 mm	10	17657	19 x 22 mm	10
17654	14 x 15 mm	10	17659	22 x 24 mm	10
17644	14 x 17 mm	10	17658	24 x 27 mm	10

**KLÍČ PRO ÚHLOVÉ BRUSKY, STAVITELNÝ**

Č.p.	specifikace	
20967	200 mm	15



**KLÍČ NA ÚHLOVÉ BRUSKY**

Č.p.	specifikace	
20968	200 mm	1

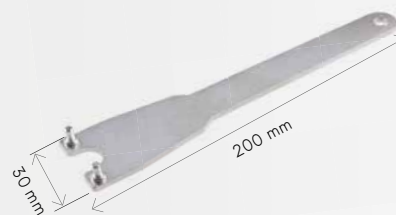

**FESTA**

KLÍČ  
LEŠENÁŘSKÝ, RÁČNOVÝ



Č.p.	specifikace	
17452	19 x 22 mm	2



**FESTA**

RÁČNA  
LEŠENÁŘSKÁ

Č.p.	specifikace	
17451	18 mm	10
17450	19 mm	10



**FESTA**

KLÍČ MOMENTOVÝ

Č.p.	specifikace	
17203	1/4" 5 - 25 Nm	1
17204	1/2" 19 - 110 Nm	1
17205	1/2" 42 - 210 Nm	1
17206	3/4" 140 - 700 Nm	1



**FESTA**

made by **HENITON**

HLAVICE NA KOLA

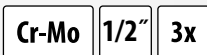

Č.p.	specifikace	
17338	21 mm	5



KLÍČ NA KOLA



Č.p.	specifikace	
17600	17, 19, 22 mm, 13/16"	16

KLÍČ NA KOLA



Č.p.	specifikace	
17601	17, 19, 21 mm	20

KLÍČ  
TELESKOPICKÝ  
NA KOLA



Č.p.	specifikace	
17603	17 x 19 mm, 21 x 23 mm	20

KLÍČ NÁSTRČNÝ  
KLOUBOVÝ



Č.p.	specifikace	
17261	16 mm	1
17262	21 mm	1

**FESTA**

KLÍČ HÁKOVÝ

CrV



Č.p.	specifikace		
17680	19 - 51 mm	165 mm	5
17681	32 - 76 mm	216 mm	5
17682	51 - 121 mm	267 mm	5

STAHOVÁK NA LOŽISKA DVOURAMENNÝ



Č.p.	max. průměr	hloubka	
23734	Ø 100 mm	50-95 mm	1
23735	Ø 150 mm	100-150 mm	1
23736	Ø 200 mm	110-190 mm	1

STAHOVÁK NA LOŽISKA TŘÍRAMENNÝ



Č.p.	max. průměr	hloubka	
23730	Ø 100 mm	50-95 mm	2
23731	Ø 150 mm	100-150 mm	2
23732	Ø 200 mm	110-190 mm	2

**FESTA**

KLÍČ NA RADIÁTOROVÉ ŠROUBENÍ

CrV 1/2"

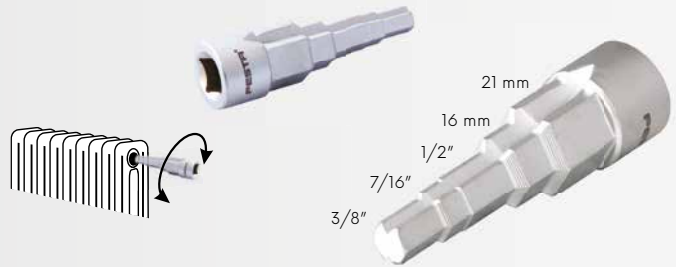

Č.p.	specifikace	
17455	pro ráčnu 1/2"	10



KLÍČ PRO ODVZDUŠNĚNÍ TOPENÍ

2x



Č.p.	specifikace	
17454	5 x 5 mm	1

KLÍČ ODVZDUŠŇOVACÍ PRO TOPNÁ TĚLESA SE ZÁSOBNÍKEM



Č.p.	specifikace	
17459	50 ml	1



**FESTA**

KLÍČ K ROZVODNÝM SKŘÍNÍM

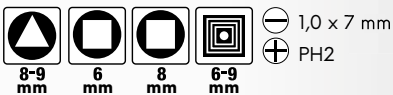

Č.p. / No.	specifikace	
17458		1



**FESTA**

KLÍČ UNIVERZÁLNÍ K ROZVODNÝM SKŘÍNÍM

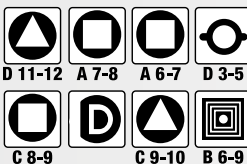

Č.p.	specifikace	
17456		50





**ERGONOMIC handle**

STANDARD +30% FESTA

**CrV** · chrom vanadiová ocel

**HRC 58-62** · tvrdost čelistí

**ERGO HANDLE** · ergonomické rukojeti z kvalitní TPE gumy

· indukčně kalené



**KLEŠTĚ KOMBINOVANÉ**

DIN 5746	TUV GS	Č.p.	specifikace	
CrV	HRC 58-62	17101	160 mm	6
		17102	180 mm	6
		17103	200 mm	6



**KLEŠTĚ BOČNÍ ŠTÍPACÍ**

DIN 5749	TUV GS	CrV	HRC 58-62	ERGO HANDLE	Č.p.	specifikace	
					17148	180 mm	6



**KLEŠTĚ BOČNÍ ŠTÍPACÍ**

DIN 5749	TUV GS	CrV	HRC 58-62	ERGO HANDLE	Č.p.	specifikace	
					17104	160 mm	6
					17105	180 mm	6



**KLEŠTĚ RADIOVÉ**

DIN 5745	TUV GS	CrV	HRC 58-62	ERGO HANDLE	Č.p.	specifikace	
					17140	160 mm	6
					17142	200 mm	6



**KLEŠTĚ RADIOVÉ ZAHNUTÉ**

DIN 5749	TUV GS	CrV	HRC 58-62	ERGO HANDLE	Č.p.	specifikace	
					17145	160 mm	6
					17146	200 mm	6



# FESTA





**FESTA**

**KLEŠTĚ KOMBINOVANÉ**

<b>DIN 5746</b>			<b>HRC 58-64</b>		
Č.p.	specifikace				
17001	160 mm				6
17002	180 mm				6
17003	200 mm				6



**FESTA**

**KLEŠTĚ BOČNÍ ŠTÍPACÍ**

<b>DIN 5749</b>			<b>HRC 58-64</b>		
Č.p.	specifikace				
17004	160 mm				6
17005	180 mm				6



**FESTA**

**KLEŠTĚ BOČNÍ ŠTÍPACÍ**

<b>DIN 5749</b>			<b>HRC 58-64</b>		
Č.p.	specifikace				
17108	180 mm				6



**FESTA**

**KLEŠTĚ ŠTÍPACÍ ČELNÍ**

<b>DIN 5748</b>			<b>HRC 58-64</b>		
Č.p.	specifikace				
17110	160 mm				6



**FESTA**

**KLEŠTĚ RADIOVÉ**

<b>DIN 5745</b>			<b>HRC 58-64</b>		
Č.p.	specifikace				
17006	160 mm				6
17011	200 mm				6



**FESTA**

**KLEŠTĚ RADIOVÉ ZAHNUTÉ**

<b>DIN 5745</b>			<b>HRC 58-64</b>		
Č.p.	specifikace				
17007	160 mm				6
17008	200 mm				6



**FESTA**

**KLEŠTĚ PLOCHÉ**

<b>DIN 5746</b>			<b>HRC 50-55</b>		
Č.p.	specifikace				
17009	160 mm				6



**FESTA**

**KLEŠTĚ OČKOVÉ**

<b>DIN 5745</b>					
Č.p.	specifikace				
17010	160 mm				6



**FESTA**

**KLEŠTĚ ODIZOLOVACÍ**

<b>DIN 5744</b>					
Č.p.	specifikace				
17024	160 mm				6



**KLEŠTĚ KOMBINOVANÉ**

<b>DIN 5746</b>				
Č.p.	specifikace			
17094	160 mm			6
17095	180 mm			6
17096	200 mm			6



**KLEŠTĚ BOČNÍ ŠTÍPACÍ**

<b>DIN 5749</b>				
Č.p.	specifikace			
17097	160 mm			6
17098	180 mm			6



**KLEŠTĚ RADIOVÉ**

<b>DIN 5745</b>				
Č.p.	specifikace			
17099	160 mm			6
17100	200 mm			6



## VDE KLEŠTĚ KOMBINOVANÉ

1000 V IEC/EN60900:2004

DIN 5746

CrV

HRC 58-62



Č.p.	specifikace	
17125	160 mm	6
17126	180 mm	6
17127	200 mm	6



## VDE KLEŠTĚ BOČNÍ ŠTÍPACÍ

1000 V IEC/EN60900:2004

DIN 5749

CrV

HRC 58-62



Č.p.	specifikace	
17128	160 mm	6



## VDE KLEŠTĚ KABELOVÉ ŠTÍPACÍ

1000 V IEC/EN60900:2004

CrV

HRC 58-62



Č.p.	specifikace	
17130	160 mm	6



## VDE KLEŠTĚ RADIOVÉ

1000 V IEC/EN60900:2004

DIN 5745

CrV

HRC 58-62



Č.p.	specifikace	
17133	160 mm	6



## VDE KLEŠTĚ RADIOVÉ ZAHNUTÉ

1000 V IEC/EN60900:2004

DIN 5745

CrV

HRC 58-62



Č.p.	specifikace	
17135	160 mm	6



## VDE KLEŠTĚ OČKOVÉ

1000 V IEC/EN60900:2004

DIN 5745

CrV

HRC 58-62



Č.p.	specifikace	
17137	160 mm	6



## VDE KLEŠTĚ ODIZOLOVACÍ

1000 V IEC/EN60900:2004

CrV

DIN 5744



Č.p.	specifikace	
17138	160 mm	6



## KLEŠTĚ ŠTÍPACÍ NA JEMNÉ KABELY

max Ø 0,2 - 2,1 mm

CrV	Č.p. I No.	Specifikace I Specification	
	17047	140 mm	10



## KLEŠTĚ ŠTÍPACÍ BOČNÍ MINI

odizolování drátu - 0,75; 1,0; 1,5; 2,5; 4,0; 6,0mm<sup>2</sup>

CrV	Č.p.	Specifikace	
	17087	145 mm	1



## KLEŠTĚ ODIZOLOVACÍ

0,5 - 6 mm<sup>2</sup>  
délka 190 mm

Č.p.	Specifikace	
17178		1



## KLEŠTĚ ODIZOLOVACÍ

Č.p.	specifikace	
17180	Ø 0,75 - 2,5 mm	12



## KLEŠTĚ ODIZOLOVACÍ

Č.p.	specifikace	
17181	Ø 0,60 - 2,6 mm	10

**NEW**



**FESTA**  
ODIZOLOVAČ  
KABELŮ  
· Ø 0,2-4 mm

**FESTA**  
ODIZOLOVAČ KABELŮ

AWG	mm <sup>2</sup>
10	6,0
12	4,0
14	2,5
16	1,5
18	1,0
20	0,5

· koaxiální kabel RG6/59  
· nízkonapěťový kabel Ø 8 - 13 mm

Č.p. Specifikace  
16205 125 mm 1

Č.p. Specifikace  
16202 125 mm 10



**FESTA**  
INDUSTRY  
KLEŠŤ  
LISOVACÍ /  
KRIMPOVACÍ

**NEW**

- AWG 22-18/16-14/12-10  
· DIN 0,5-1,0/1,5-2,5/4-6mm<sup>2</sup>
- AWG 20-16/16-14/12-10/8  
· DIN 0,5-1,0/1,5-2,5/4-6/10mm<sup>2</sup>
- AWG 20-18/16-14/12-10  
· DIN 0,5-1,0/1,5-2,5/4-6mm<sup>2</sup>
- AWG 20/18/17/16/14/12  
· DIN 0,5/0,75/1,0/1,5/2,5/4,0mm<sup>2</sup>
- AWG 10/8/6  
· DIN 6/10/16mm<sup>2</sup>

6x  
Č.p. Specifikace  
18445 1



**FESTA**  
INDUSTRY  
KLEŠŤ  
ODIZOLOVACÍ / KRIMPOVACÍ 5V1



Č.p. Specifikace  
16206 1



**FESTA**  
INDUSTRY  
KLEŠŤ  
ODIZOLOVACÍ / KRIMPOVACÍ 5V1

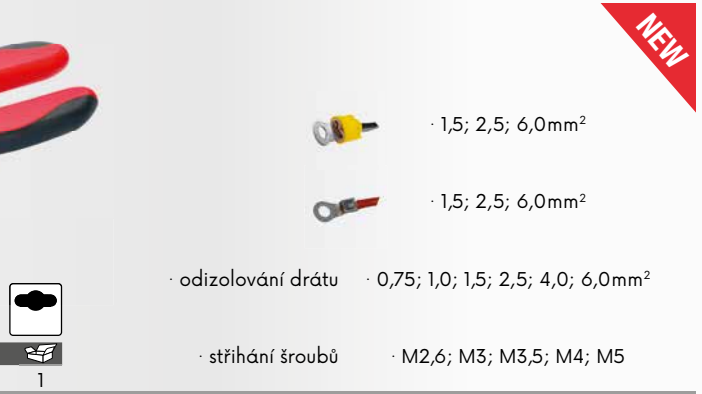

Č.p. Specifikace  
16208 1



**FESTA**

**KLEŠTĚ MULTIFUNKČNÍ**

- 9 funkcí
- pouzdro

**CrV**

Č.p. specifikace  
**16232**



12



**FESTA**

**KLEŠTĚ MINI SADA**

**4x**

Č.p. specifikace  
**17040**



6



**FESTA**

**KLEŠTĚ KOMBINOVANÉ MINI**

Č.p. specifikace  
**17041** 110 mm



12



**FESTA**

**KLEŠTĚ BOČNÍ ŠTÍPACÍ MINI**

Č.p. specifikace  
**17042** 110 mm



12



**FESTA**

**KLEŠTĚ ČELNÍ ŠTÍPACÍ MINI**

Č.p. specifikace  
**17043** 100 mm



12



**FESTA**

**KLEŠTĚ RADIOVÉ MINI**

Č.p. specifikace  
**17044** 120 mm



12



**FESTA**

**KLEŠTĚ OČKOVÉ MINI**

Č.p. specifikace  
**17045** 120 mm



12



**KLEŠTĚ NA SEGEROVY KROUŽKY**

Č.p. specifikace  
**17025** sada



10



17190



17191



17192



17193

**FESTA**

**KLEŠTĚ NA SEGEROVY KROUŽKY**

Č.p. specifikace  
**17190** 180 mm vnitřní  
**17191** 180 mm vnější



6

**FESTA**

**KLEŠTĚ NA SEGEROVY KROUŽKY**

Č.p. specifikace  
**17192** 180 mm vnitřní  
**17193** 180 mm vnější



15

## FESTA

### KLEŠTĚ MULTIFUNKČNÍ

· pro montáž oplacení

CrV



Č.p.	specifikace
17109	270 mm



### KLEŠTĚ RYCHLOUPÍNACÍ

Č.p.	Specifikace
17150	220 mm



### KLEŠTĚ RYCHLOUPÍNACÍ

Č.p.	Specifikace
17151	225 mm



### KLEŠTĚ RYCHLOUPÍNACÍ

Č.p.	specifikace
17034	220 mm



## FESTA

### KLEŠTĚ RYCHLOUPÍNACÍ

Č.p.	specifikace
17036	270 mm



### KLEŠTĚ RYCHLOUPÍNACÍ

Č.p.	specifikace
17035	220 mm



## FESTA

### KLEŠTĚ RYCHLOUPÍNACÍ

Č.p.	specifikace
17023	220 mm



## FESTA

### HASÁK 45°, S

CrV



Č.p.	specifikace
17067	1"   330 mm
17068	1,5"   420 mm
17069	2"   540 mm



## FESTA

### HASÁK SE STAVĚCÍM ŠROUBEM

CrV

Č.p.	specifikace
17063	230 mm
17064	300 mm

## FESTA

### HASÁK 90°

CrV



Č.p.	specifikace
17075	1"   330 mm
17076	1,5"   420 mm
17077	2"   540 mm



## FESTA

### HASÁK 90°

CrV



Č.p.	specifikace
17070	2,5"   355 mm
17071	3"   455 mm
17072	3,5"   610 mm



Č.p.	specifikace
17065	260 mm
17066	300 mm

### HASÁK S VODÍCÍ MATICÍ

## FESTA

### KLEŠTĚ SIKO



CrV



Č.p.	specifikace	rozsah čelistí	1
16500	180 mm	0 - 40 mm	1
16501	250 mm	0 - 52 mm	1
16502	300 mm	0 - 68 mm	1

## FESTA

### KLEŠTĚ SIKO S TLAČÍTKEM



CrV



Č.p.	specifikace	rozsah čelistí	6
17059	180 mm	0 - 30 mm	6
17061	250 mm	0 - 30 mm	6
17062	300 mm	0 - 40 mm	6
17080	400 mm	0 - 84 mm	4



## FESTA

### KLEŠTĚ SIKO S TLAČÍTKEM



CrV



Č.p.	specifikace	rozsah čelistí	6
17084	250 mm	0 - 30 mm	6

## FESTA

### KLEŠTĚ SIKO



CrV



Č.p.	specifikace	rozsah čelistí	6
17086	250 mm	0 - 50 mm	6

## FESTA

### KLEŠTĚ SIKO



CrV



Č.p.	specifikace	rozsah čelistí	6
17081	180 mm	0 - 30 mm	6
17014	250 mm	0 - 30 mm	6
17082	300 mm	0 - 50 mm	6

## FESTA

### KLEŠTĚ SIKO AUTOMATICKY STAVITELNÉ



CrV



Č.p.	specifikace	rozsah čelistí	6
17079	250 mm	0 - 50 mm	6

## FESTA

### KLEŠTĚ SIKO



CrV



Č.p.	specifikace	rozsah čelistí	6
17012	250 mm	0 - 40 mm	6
17060	300 mm	0 - 50 mm	10

## FESTA

### KLEŠTĚ SIKO



CrV



Č.p.	specifikace	rozsah čelistí	6
17013	250 mm	0 - 30 mm	6
17033	300 mm	0 - 50 mm	6

### ČELISTI PĚŠŤOVÉ PRO KLEŠTĚ SIKO

· vhodné pro 17061, 17079, 17086



Č.p.	specifikace	1
17085	1 pár	1

## FESTA

### KLEŠTĚ NA LANKA

- ocelové dráty
- ACSR kabely
- letecké kabely

CrV

max. Ø 6 mm



Č.p.	specifikace	6
17029	200 mm	6

## FESTA

### KLEŠTĚ NA LANKA NA LANA

- ocelové dráty
- ACSR kabely
- letecké kabely

CrV

max. Ø 12 mm



Č.p.	specifikace	8
17039	24'   610 mm	8

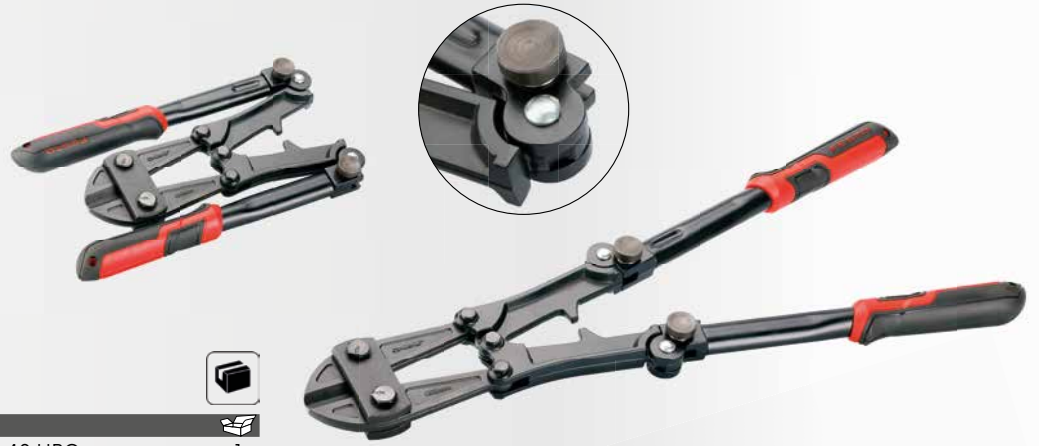

**FESTA**

## KLEŠTĚ PÁKOVÉ SKLÁDACÍ

**Cr-Mo**



Č.p.	specifikace	max. Ø drátu	
17049	18'   450 mm	max. 6 mm < 40 HRC	1

**FESTA**

## KLEŠTĚ PÁKOVÉ PROFESIONÁLNÍ

**Cr-Mo HRC 58-62**



Č.p.	specifikace	max. Ø drátu	
17051	14'   350 mm	max. 5 mm < 45 HRC	1
17052	18'   450 mm	max. 6 mm < 45 HRC	1
17053	24'   610 mm	max. 8 mm < 45 HRC	1
17054	30'   760 mm	max. 10 mm < 45 HRC	1
17048	36'   900 mm	max. 12 mm < 45 HRC	1



**FESTA**

## KLEŠTĚ PÁKOVÉ PROFESIONÁLNÍ

· čelisti na kabely a lanka

**Cr-Mo HRC 58-62**



Č.p.	specifikace	max. Ø drátu	max. Ø lanka	max. Ø kabelu	
17055	14'   360 mm	max. 5 mm < 45 HRC	max. 3,5 mm	max. 8 mm	1
17056	18'   460 mm	max. 6 mm < 45 HRC	max. 5 mm	max. 10 mm	1
17057	24'   610 mm	max. 8 mm < 45 HRC	max. 7 mm	max. 12 mm	1
17058	30'   760 mm	max. 10 mm < 45 HRC	max. 9 mm	max. 14 mm	1
17046	35'   900 mm	max. 12 mm < 45 HRC	max. 10 mm	max. 16 mm	1



**FESTA**

## KLEŠTĚ PÁKOVÉ

**Cr-Mo HRC 57-62 max. Ø 4 mm**



Č.p.	specifikace	max. Ø drátu	
17038	8'   210 mm	max. 4 mm < 30 HRC	10



**FESTA**

## KLEŠTĚ ŠTÍPACÍ

- měkký drát: Ø 6 mm
- středně tvrdý drát: Ø 5 mm
- tvrdý drát: Ø 4 mm

**CrV**



Č.p.	specifikace	
17078	200 mm	12



## KLEŠTĚ PÁKOVÉ



Č.p.	specifikace	max. Ø drátu	
17028	14'   350 mm	max. 5 mm < 30 HRC	30
17020	18'   450 mm	max. 6 mm < 30 HRC	6
17021	24'   610 mm	max. 8 mm < 30 HRC	10
17022	30'   760 mm	max. 10 mm < 30 HRC	5

**NEW**



**FESTA**  
KLEŠTĚ ŠTÍPACÍ ČELNÍ

<b>CrV</b>	<b>HRC 58-62</b>	
Č.p.	Specifikace	
17172	200 mm	1



**FESTA**  
KLEŠTĚ ŠTÍPACÍ ČELNÍ

<b>CrV</b>		
Č.p.	specifikace	
17300	160 mm	1
17301	180 mm	10
17302	200 mm	6
17303	250 mm	1



**FESTA**  
KLEŠTĚ RABITOVÉ

<b>CrV</b>		
Č.p.	specifikace	
17305	220 mm	5
17306	250 mm	1
17304	275 mm	6



KLEŠTĚ ŠTÍPACÍ ČELNÍ

Č.p.	specifikace	
17015	160 mm	6
17016	180 mm	6
17017	200 mm	6



KLEŠTĚ RABITOVÉ

Č.p.	specifikace	
17019	220 mm	6
17083	275 mm	6



**FESTA**  
KLEŠTĚ KLEMPÍŘSKÉ ROVNÉ

Č.p.	specifikace	
17089	150 x 215 mm	2

**NEW**



**FESTA**  
KLEŠTĚ KLEMPÍŘSKÉ PŘEHÝBACÍ

Č.p.	Specifikace	
17341	24 x 180 mm	1

**NEW**



**FESTA**  
KLEŠTĚ KLEMPÍŘSKÉ PŘEHÝBACÍ VYHNUTÉ 45°

Č.p.	Specifikace	
17342	24 x 180 mm	1



**FESTA**  
KLEŠTĚ KLEMPÍŘSKÉ ROVNÉ

Č.p.	specifikace	
17093	95 x 270 mm	6



**FESTA**  
KLEŠTĚ KLEMPÍŘSKÉ VYHNUTÉ 45°

Č.p.	specifikace	
17091	50 x 280 mm	10



**FESTA**  
KLEŠTĚ KLEMPÍŘSKÉ VYHNUTÉ 90°

Č.p.	specifikace	
17092	50 x 260 mm	10



**FESTA**  
KLEŠTĚ KLEMPÍŘSKÉ ROVNÉ

Č.p.	specifikace	
17090	50 x 280 mm	10



**FESTA**

NŮŽKY NA PLECH

**CrV**



Č.p.	specifikace	
17170	50   250 mm	6



NŮŽKY NA PLECH

**CrV**



Č.p.	specifikace	
17167	70   300 mm	5



NŮŽKY NA PLECH

**CrV**



Č.p.	specifikace	
17165	60   250 mm	5



NŮŽKY NA PLECH

**CrV**



Č.p.	specifikace	
17169	35   250 mm	5

**FESTA**

NŮŽKY  
NA PLECH  
PRODLOUŽENÉ



**Cr-Mo** **HRC 58-62**

Č.p.	specifikace	
17113	rovné 80   300 mm	6



**FESTA**

NŮŽKY NA PLECH

**Cr-Mo** **HRC 58-62**

Č.p.	specifikace	
17111	rovné 40   250 mm	6
17116	pravé 40   250 mm	6
17121	levé 40   250 mm	6

**FESTA**

NŮŽKY NA PLECH

**Cr-Mo** **HRC 58-62**

Č.p.	specifikace	
17112	rovné 40   260 mm	6
17117	pravé 40   260 mm	6
17122	levé 40   260 mm	6



NŮŽKY NA PLECH

**CrV**



Č.p.	specifikace	
17169	35   250 mm	5



NÁSTAVEC NA STRÍHÁNÍ PLECHU

 Steel 0.8-1 mm	 Cu 1.5 mm	 ALU 1.5 mm	
Č.p.	specifikace		
20364			1



NŮŽKY PROSTRÍHOVACÍ NA PLECH

max 0,8 mm



Č.p.	specifikace	
17186	265 mm	



NÁSTAVEC NA STRÍHÁNÍ PLECHU



Max. tloušťka plechu

- 1,8 mm - ocel
- 1,2 mm - nerez
- 2 mm - plasty, hliník, měď

Č.p.	specifikace	
20363		



NŮŽKY PÁKOVÉ

	17175 max. 4mm	17177 5mm
	max. ø10mm	ø12mm
	max. 8x8mm	10x10mm

Č.p.	specifikace	
17175	150 mm	1
17177	250 mm	1

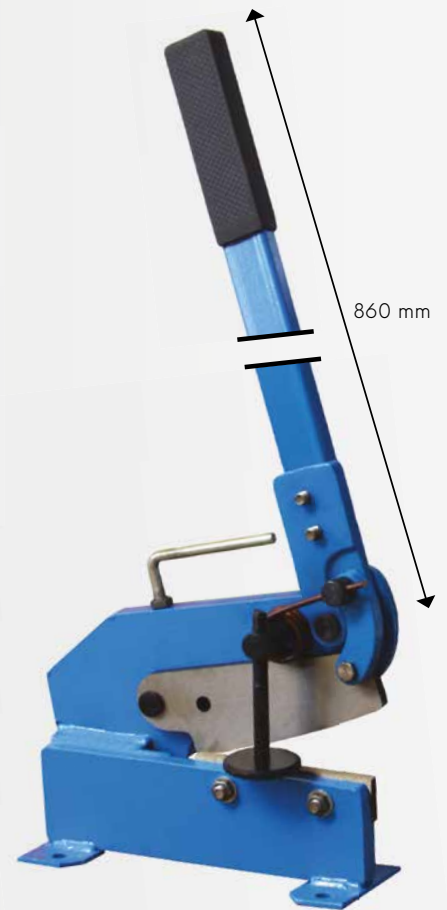



NŮŽKY TECHNICKÉ

INOX



Č.p.	specifikace	
16420	60   200 mm	12



NŮŽKY

INOX



Č.p.	specifikace	
17159	65   220 mm	12



NŮŽKY TECHNICKÉ

INOX



Č.p.	specifikace	
17158	50   150 mm	10



NŮŽKY

INOX



Č.p.	specifikace	
17160	70   210 mm	12



NŮŽKY

INOX

Č.p.	specifikace	
16405	14 cm	24
16406	17 cm	24
16407	19 cm	24
16408	21,5 cm	12



NŮŽKY SADA

3x INOX

Č.p.	specifikace	
16401	3 ks	48



FESTA

KLEŠTĚ DĚROVACÍ



Č.p.	specifikace	
17185	Ø 2; 2,5; 3; 3,5; 4; 4,5 mm	12



FESTA

NŮŽKY NA PVC LIŠTY A TRUBKY

Použití pro: lišty, trubky, profily



Č.p.	specifikace	
17050	60   250 mm    ø 17 mm, ø 20 mm, ø 27 mm	8



KLEŠTĚ SPOJOVACÍ NA PROFILY - PERFORAČNÍ



Č.p.	specifikace	
17187	350 mm	6



KLEŠTĚ SPOJOVACÍ NA PROFILY - PERFORAČNÍ



Č.p.	specifikace	
17188	250 mm	12



KLEŠTĚ NA HMOŽDINKY



Č.p.	specifikace	
17189	255 mm	12



# FESTA

**FESTA**

**KLEŠTĚ  
NÝTOVACÍ**

**Cr-Mo**

- Ø 2,4 mm
- Ø 3,2 mm
- Ø 4,0 mm
- Ø 4,8 mm



Č.p. 24007      specifikace 200 mm

1

**FESTA**

**KLEŠTĚ  
NÝTOVACÍ**

**Cr-Mo**

- Ø 2,4 mm
- Ø 3,2 mm
- Ø 4,0 mm
- Ø 4,8 mm



Č.p. 24010      specifikace 250 mm

12

**FESTA**

**KLEŠTĚ  
NÝTOVACÍ**

**Cr-Mo**

- Ø 2,4 mm
- Ø 3,2 mm
- Ø 4,0 mm
- Ø 4,8 mm
- Ø 6,4 mm



Č.p. 24017      specifikace 280 mm

1

**FESTA**

**KLEŠTĚ NÝTOVACÍ**

**Cr-Mo**

- Ø 2,4 mm
- Ø 3,2 mm
- Ø 4,0 mm
- Ø 4,8 mm
- Ø 6,4 mm



Č.p. 24015      specifikace 530 mm

1

**FESTA**

**KLEŠTĚ  
NÝTOVACÍ**

**Cr-Mo**

- Ø 2,4 mm
- Ø 3,2 mm
- Ø 4,0 mm
- Ø 4,8 mm



Č.p. 24030      specifikace 255 mm

24

**FESTA**

**KLEŠTĚ  
NÝTOVACÍ  
S OTOČNOU  
HLAVOU**

**Cr-Mo**



Č.p. 24020      specifikace 290 mm

8



## KLEŠTĚ NÝTOVACÍ PEVNÉ



Č.p.	specifikace	
24001	260 mm	6

## KLEŠTĚ NÝTOVACÍ + NÝTY

**Cr-Mo**



- Ø 2,4 x 6 mm
- Ø 3,2 x 6 mm
- Ø 4,0 x 6 mm
- Ø 4,8 x 6 mm



Č.p.	specifikace	
24005	260 mm	5



## KLEŠTĚ NÝTOVACÍ



Č.p.	specifikace	
24000	240 mm	24

**FESTA**

## NÁSTAVEC NÝTOVACÍ NA VRTAČKU

- Ø 2,4 mm
- Ø 3,2 mm
- Ø 4,0 mm
- Ø 4,8 mm



**Cr-Mo**

Č.p.	specifikace	
24008		1



## NÝTY HLINÍKOVÉ TRHACÍ

**ALU**

**50x**

Č.p.	specifikace	
23970	3,2 x 6 mm	25
23971	3,2 x 8 mm	25
23972	3,2 x 10 mm	25
23973	3,2 x 12 mm	25
23974	3,2 x 14 mm	25
23975	4,0 x 6 mm	25
23976	4,0 x 8 mm	25
23977	4,0 x 10 mm	25
23978	4,0 x 12 mm	25
23979	4,0 x 14 mm	25
23985	4,8 x 6 mm	25
23986	4,8 x 8 mm	25
23987	4,8 x 10 mm	25
23988	4,8 x 12 mm	25
23989	4,8 x 14 mm	25



**FESTA**

## KLEŠTĚ NÝTOVACÍ PRO NÝTOVACÍ MATICE

**Cr-Mo**

- M3
- M4
- M5
- M6
- M8
- M10



Č.p.	specifikace	
24036	330 mm	1



**FESTA**

## HLAVICE DO NÝTOVACÍCH KLEŠTÍ PRO NÝTOVACÍ MATICE

vhodné pro 24035, 24036

**Cr-Mo**

Č.p.	specifikace	
24038	M3	1
24039	M4	1
24040	M5	1
24041	M6	1
24042	M8	1
24043	M10	1



**FESTA**

## KLEŠTĚ NÝTOVACÍ PRO NÝTOVACÍ MATICE

**Cr-Mo**

- M3
- M4
- M5
- M6



Č.p.	specifikace	
24035	200 mm	1



## MATICE NÝTOVACÍ,

**ALU**





**20x**

Č.p.	specifikace	
23950	M3 x 9 mm	20
23951	M4 x 11 mm	20
23952	M5 x 12 mm	50
23953	M6 x 14 mm	50
23954	M8 x 16,5 mm	25
23955	M10 x 18 mm	20



**FESTA**

**SPONKOVAČKA 5 V 1**





-  | 6 - 14 mm  
23960 - 23964  
23760 - 23764,  
23906 - 23914
-  | 10 - 14 mm  
23965
-  | 15 mm  
23966
-  | 15 mm  
23967



Č.p. specifikace  23927 6

**FESTA**

**SPONKOVAČKA 4 V 1**



-  | 6 - 14 mm  
23960 - 23964
-  | 12 mm  
23965
-  | 14 mm  
23966
-  | 14 mm  
23967



Č.p. specifikace  23924 12

**FESTA**

**SPONKOVAČKA 3 V 1**

-  | 6 - 14 mm  
23960 - 23964
-  | 14 mm  
23966
-  | 14 mm  
23967





Č.p. specifikace  23923 12



**FESTA**

**SPONKOVAČKA**

-  53 | 4 - 14 mm  
23904 - 23914,  
23760 - 23765

Č.p. specifikace  23925 4 - 14 mm s aretací 20

**SPONKOVAČKA**

-  53 | 4 - 14 mm  
23760 - 23765,  
23904 - 23914

Č.p. specifikace  23800 20

**SPONKOVAČKA**

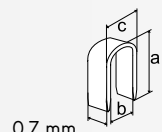

0,7 mm  
a=9-11 mm, b=5,5mm, c=6,4mm

Č.p. specifikace  23920 4

**FESTA**

**KLADIVO SPONKOVACÍ**

-  | 6 - 10 mm  
23960 - 23962

Č.p. specifikace  23922 10



**KLADIVO SPONKOVACÍ**

-  | 6 - 10 mm  
23960 - 23962

Č.p. specifikace  23928 6



**FESTA**

**ODSTRAŇOVAČ SPON**

Č.p. specifikace  23945 25



**FESTA**

SPONY EXTRA



Č.p.	specifikace	
23960	b=6 mm, 1000 ks	50
23961	b=8 mm, 1000 ks	50
23962	b=10 mm, 1000 ks	50
23963	b=12 mm, 1000 ks	50
23964	b=14 mm, 1000 ks	50

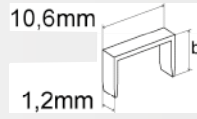

**FESTA**

SPONY



Č.p.	specifikace	
23965	α=12 mm, b=6,5 mm, c=7,5 mm, 1000 TW	50

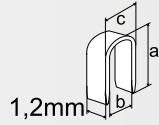

SPONY - TYP 53



Č.p.	specifikace	
23904	b=4 mm 1000 ks	200
23906	b=6 mm 1000 ks	200
23908	b=8 mm 1000 ks	200
23910	b=10 mm 1000 ks	200
23912	b=12 mm 1000 ks	200
23914	b=14 mm 1000 ks	200

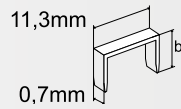

**FESTA**

HŘEBÍKY



Č.p.	specifikace	
23966	hřebíky 4 mm   1000 TW	100



**FESTA**

HŘEBÍKY



Č.p.	specifikace	
23967	hřebíky 14 mm   1000 TW	100



SPONY - TYP 53



Č.p.	specifikace	
23760	b=4 mm 2000 ks	10
23761	b=6 mm 2000 ks	10
23762	b=8 mm 2000 ks	10
23763	b=10 mm 2000 ks	10
23764	b=12 mm 2000 ks	10

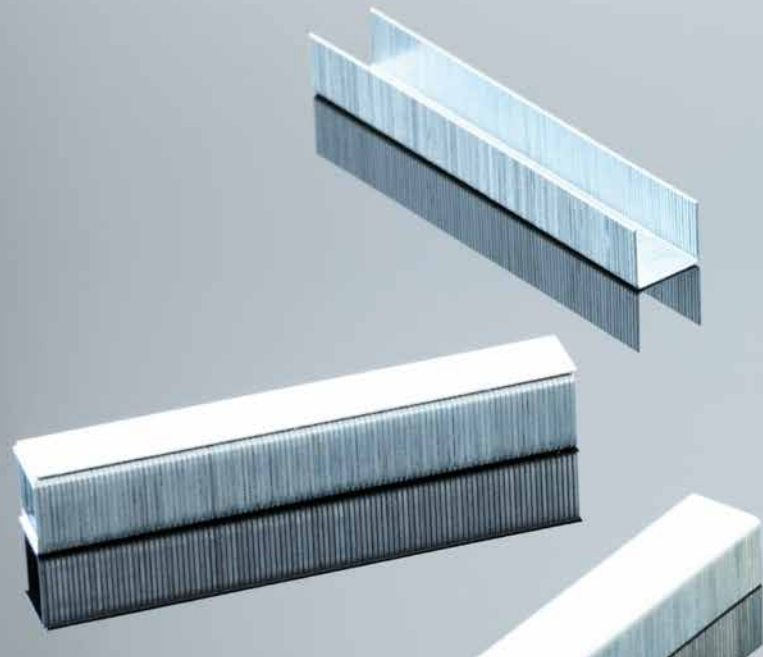
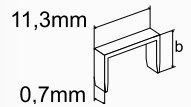

**FESTA**



## FESTA

### KARTÁČ OCELOVÝ



Č.p.	specifikace	řady	
22080	270 mm	5 řad	12

## FESTA

### KARTÁČ MOSAZNÝ



Č.p.	specifikace	řady	
22082	270 mm	5 řad	12

## FESTA

### KARTÁČE SADA



nylon, nerez, mosaz

3x



Č.p.	specifikace	
22086	180 mm	12

### KARTÁČE OCELOVÉ, POMOŠAZENÉ SADA



3x



Č.p.	řady	
22081	3 řady	12



22158



22159

### ŠTĚTEC DRÁTĚNÝ

Č.p.	specifikace	drát	
22158	200 mm	ocel	36
22159	200 mm	mosaz	36



22035



22036

### KARTÁČ VLNITÝ

Č.p.	specifikace	drát	
22035	270 mm	ocel	24
22036	270 mm	nerez	24



### KARTÁČ OCELOVÝ

Č.p.	specifikace	řady	
22033	300 mm	4 řady	12
22034	300 mm	5 řad	12



### KARTÁČ POMOŠAZENÝ

Č.p.	řady	
22078	3 řady	20



### KARTÁČ POMOŠAZENÝ

Č.p.	specifikace	řady	
22079	300 mm	4 řady	6

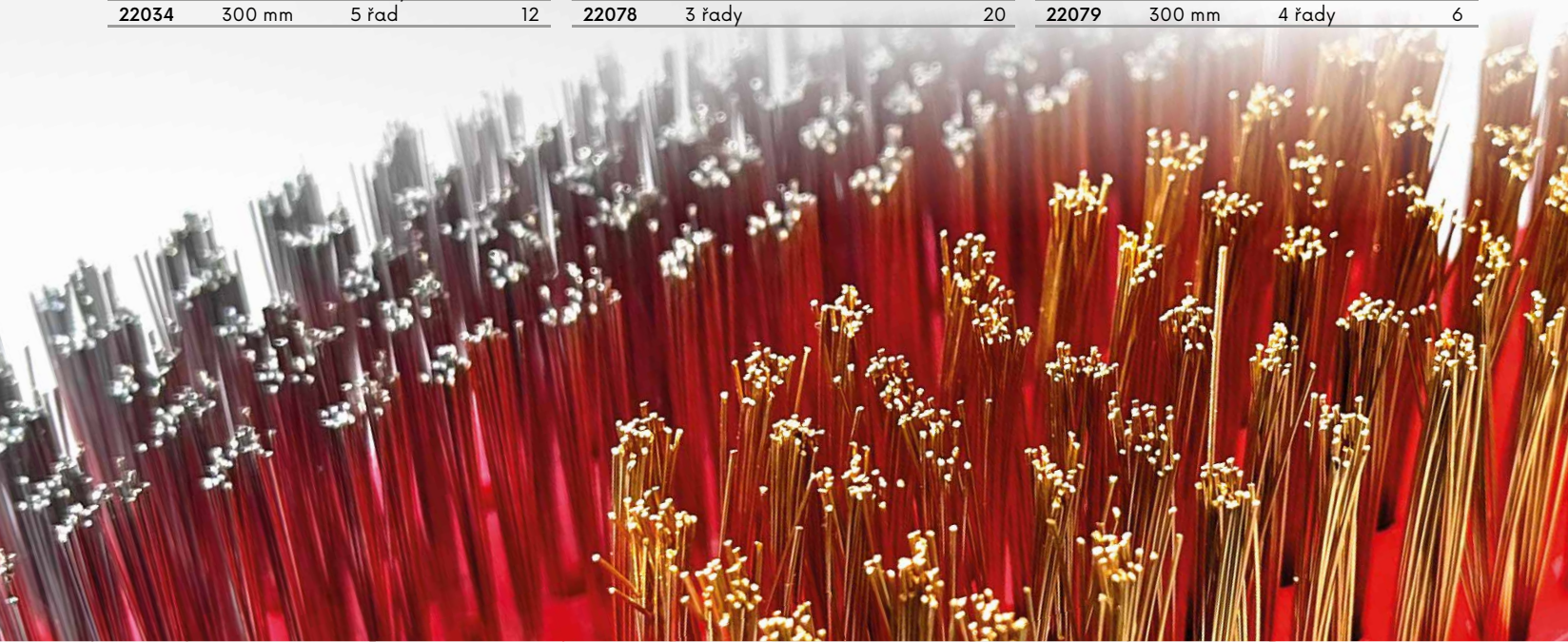

# FESTA

**FESTA**
**PILNÍK PLOCHÝ**

Č.p.	specifikace	hrubost	
22206	150 mm	2	10
22180	250 mm	2	10

**FESTA**
**PILNÍK PŮLKULATÝ**

Č.p.	specifikace	hrubost	
22207	150 mm	2	10
22182	250 mm	2	10

**FESTA**
**PILNÍK ČTYŘHRANNÝ**

Č.p.	specifikace	hrubost	
22184	250 mm	2	10

**FESTA**
**PILNÍK TROJHRANNÝ**



Č.p.	specifikace	hrubost	
22183	250 mm	2	10

**FESTA**
**PILNÍK KULATÝ**

Č.p.	specifikace	hrubost	
22181	250 mm	2	10

**FESTA**
**PILNÍK TROJHRANNÝ NA PILOVÉ ZUBY**

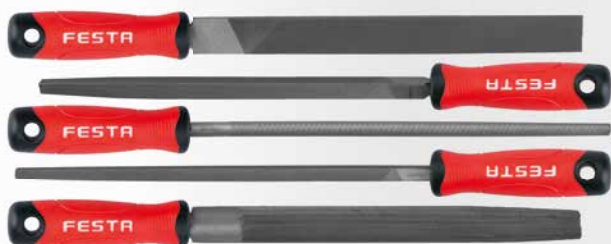
Č.p.	specifikace	hrubost	
22178	150 mm	1	10

**FESTA**
**PILNÍKY - SADA**

Č.p.	specifikace	hrubost	
22209	150 mm	2	10
22186	250 mm	2	5

**FESTA**
**PILNÍKY - SADA**

Č.p.	specifikace	hrubost	
22208	150 mm	2	10
22185	250 mm	2	5



**FESTA**

## PILNÍK NA ŘETĚZOVOU PILU



Č.p.	specifikace		Č.p.	specifikace	
22170	200 mm 3,5 mm	10	22173	200 mm 5 mm	10
22171	200 mm 4 mm	10	22174	200 mm 5,5 mm	10
22172	200 mm 4,5 mm	10			



Ø 4 mm

**FESTA**

## SADA NA BROUŠENÍ ŘETĚŽŮ



Č.p.	specifikace	
22190	300 mm	5



**FESTA**

## PILNÍKY JEHLOVÉ - SADA



10x	Č.p.	specifikace	20
	22188		



**FESTA**

## PILNÍKY DIAMANTOVÉ - SADA



10x	Č.p.	specifikace	25
	22189		



**FESTA**

## RAŠPLE PLOCHÁ



Č.p.	specifikace	
22202	150 mm	10
22197	300 mm	10

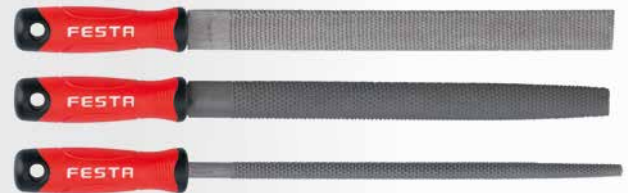

**FESTA**

## RAŠPLE SADA



3x	Č.p.	specifikace	5
	22196	250 mm	



**FESTA**

## RAŠPLE PŮLKULATÁ



Č.p.	specifikace	
22203	150 mm	6
22199	300 mm	6



**FESTA**

## RAŠPLE KULATÁ



Č.p.	specifikace	
22204	150 mm	10
22205	250 mm	10
22198	300 mm	10



**FESTA**

PILA NA KOV



Č.p.	specifikace	
24104	300 mm	6

**FESTA**

PILA NA KOV

· zesílený rám



Č.p.	specifikace	
24102	300 mm	6

PILA NA KOV

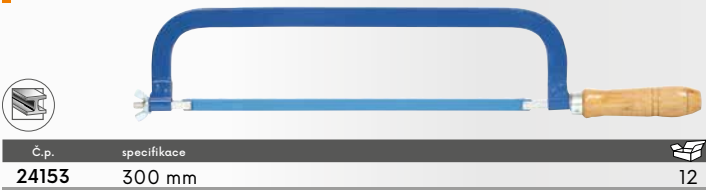

Č.p.	specifikace	
24153	300 mm	12

**FESTA**

PILA NA KOV



Č.p.	specifikace	
24100	300 mm	12

PILA NA KOV

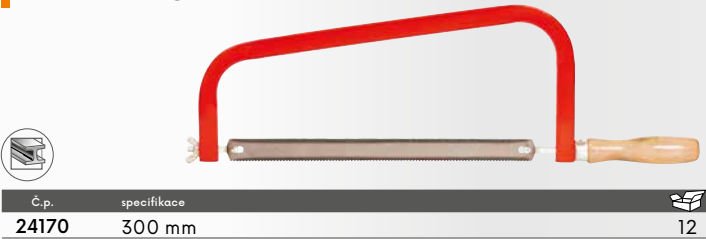

Č.p.	specifikace	
24170	300 mm	12

**FESTA**

PILA NA KOV



Č.p.	specifikace	
24126	300 x 25 x 0,65 mm TPI 24   14	10

**FESTA**

PILA NA KOV

· plátky 24108



Č.p.	specifikace	
24125	150 mm	6

**FESTA**

PILA NA KOV

· plátky 24109



Č.p.	specifikace	
24124	260 mm	12



LUPÉNKOVÁ PILA

Č.p.	specifikace	
24121	pila	12
24110	pilový plátek	30



PILA

· 5x pilový plátek

Č.p.	specifikace	
24122	pila	20
24111	pilový plátek	30

## FESTA

### PILA OCÁSKA

**TEFLON** · 3 x broušené a kalené zuby

Č.p.	specifikace	
24143	300 mm	12
24144	400 mm	12
24145	500 mm	12



## FESTA

### PILA ČEPOVKA

**TEFLON** · 3 x broušené a kalené zuby

Č.p.	specifikace	
24147	300 mm	6



## FESTA

### PILA DĚROVKA

· 3 x broušené a kalené zuby

Č.p.	specifikace	
24149	300 mm	12



## FESTA

### PILA JAPONSKÁ

**SK5** · 3 x broušené a kalené zuby

Č.p.	Specifikace	
24134	250 mm 0,5 mm	10



## FESTA

### PILA JAPONSKÁ

**SK5** · 3 x broušené a kalené zuby

Č.p.	Specifikace	
24115	260 mm 0,6 mm	10



## FESTA

### PILA JAPONSKÁ

**SK5** · 3 x broušené a kalené zuby

Č.p.	Specifikace	
24114	260 mm 0,6 mm	10

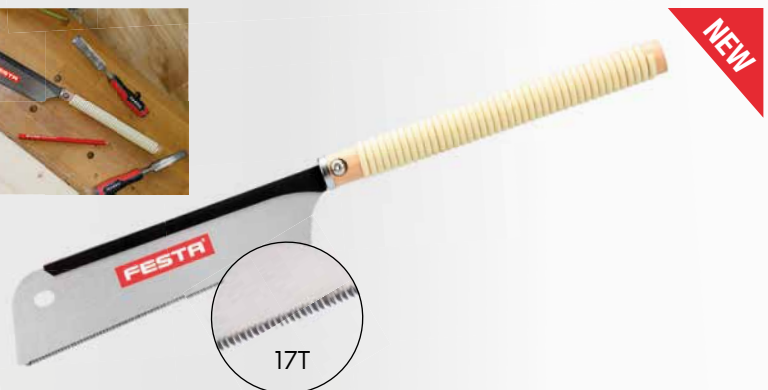

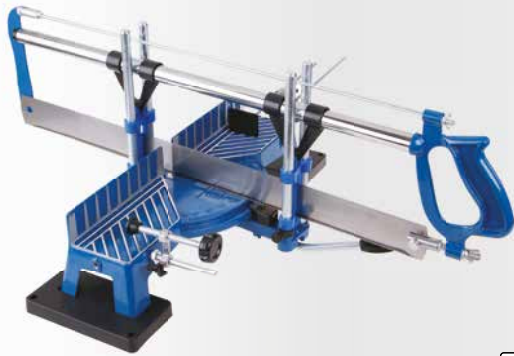

## PILA POKOSOVÁ PROFI



Č.p.	specifikace	
24130	600 mm	1
24131	600 mm, pilový plátek	1



## KOSOŘEZ + PILA



Č.p.	specifikace	
24148	300 mm	25

POKOSNICE  
DŘEVĚNÁ

· buk  
MADE IN  
EU

Č.p.	specifikace	
24171	80 x 300 mm	10

POKOSNICE  
PLASTOVÁ

Č.p.	specifikace	
24133	300 x 140 mm	18

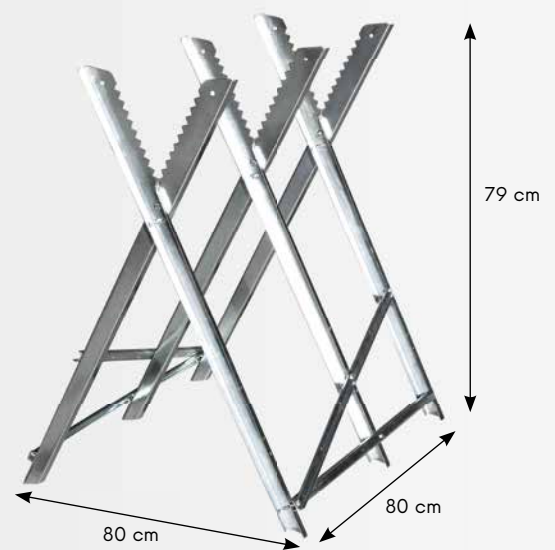

## KOZA NA ŘEZÁNÍ DŘEVA



Č.p.	specifikace	
37570	max. 150 kg	3

## FESTA

PILA  
OBLOUKOVÁ

· kalené zuby



Č.p.	specifikace		Č.p.	specifikace	
24141	450 mm	12	24136	760 mm	12
24140	533 mm	12	24142	800 mm	12
24135	610 mm	12	24137	914 mm	12

## FESTA

PILA  
OBLOUKOVÁ  
OTOČNÁ

· kalené zuby



Č.p.	specifikace	
24173	350 mm	24

PILA  
ZAHRADNÍ

Č.p.	specifikace	
24151	300 mm	10

PILA  
ZAHRADNÍ  
OTOČNÁ

Č.p.	specifikace	
24150	300 mm	5

PILA

Č.p.	specifikace	
24128	450 mm plátky 24192	6



**FESTA**

PILA ZAVÍRACÍ



· 3 x broušené a kalené zuby



Č.p.	specifikace	
45061	150 mm s krytem rukojeti	12



**FESTA**

PILA ZAVÍRACÍ



· 3 x broušené a kalené zuby



Č.p.	specifikace	
45060	180 mm	6



**FESTA**

PILA S POUZDREM



· 3 x broušené a kalené zuby



Č.p.	specifikace	
45062	260 mm s pouzdem	24



PILA PROŘEZÁVACÍ



· 3 x broušené a kalené zuby

Č.p.	specifikace	
24152	350 mm 6 tpi	12

**FESTA**

PILA TELESKOPICKÁ PROŘEZÁVACÍ



· 3 x broušené a kalené zuby

Č.p.	specifikace	
45033	230 - 490 mm	1



HOUSENICE S PILOU



Č.p.	specifikace	
45030	pilka 30 cm teleskopická tyč 260 cm	6
45031	pilka 30 cm	6

HOUSENICE



Č.p.	specifikace	
45032	kovová housenice bez pilky	6

**FESTA**

**PILA NA POLYSTYREN**



Č.p.	specifikace	
24174	380 mm	1

**FESTA**

**PILA NA DUTÉ CIHLY (PORO-THERM)**



Č.p.	specifikace	
24181	550 mm	1

**FESTA**

**PILA NA POROBETON**



Č.p.	specifikace	
24158	22   22 SK zubů - 450 mm	5

**FESTA**

**PILA NA POROBETON**

· kalené zuby



Č.p.	specifikace	
24175	bez SK zubů - 600 mm EU	2
24178	bez SK zubů - 600 mm	6

**FESTA**

**PILKA NA SÁDROKARTON**



· 3 x broušené a kalené zuby

Č.p.	specifikace	
24159	150 mm	12

**PILKA VRTACÍ NA SÁDROKARTON**



Č.p.	specifikace	
24190	270 mm	10

**FESTA**

**PILA NA POROBETON**



Č.p.	specifikace	
24155	34   17 SK zubů - 600 mm	2
24156	34   34 SK zubů - 600 mm	2

**FESTA**

**PILA NA POROBETON**



Č.p.	specifikace	
24176	34   17 SK zubů - 750 mm	6
24177	34   34 SK zubů - 750 mm	6





**FESTA**

**KLADIVO**

· jasanová násada

**DIN 1041**

Č.p.	specifikace	
19081	100 g	1
19082	200 g	1
19083	300 g	1
19084	400 g	1
19085	500 g	1
19086	600 g	1
19088	800 g	1
19090	1000 g	1
19092	1500 g	1
19095	2000 g	1



**FESTA**

**KLADIVO**

· jasanová násada

**DIN 1041**

Č.p.	specifikace	
19096	3000 g	1
19097	4000 g	1
19098	5000 g	1
19106	6000 g	1
19108	8000 g	1
19109	10000 g	1



**FESTA**

**PALICE**

· jasanová násada

**DIN 6475**

Č.p.	specifikace	
19041	1000 g	1
19042	1250 g	1
19043	1500 g	1
19044	2000 g	1



**FESTA**

**PALICE**

· jasanová násada

**DIN 6475**

Č.p.	specifikace	
19045	3000 g	1
19046	4000 g	1
19074	5000 g	1
19075	6000 g	1
19076	8000 g	1
19077	10000 g	1



**FESTA**

**KLADIVO FIBERGLASS**

· násada fiberglass

Č.p.	specifikace	
19021	100 g	12
19022	200 g	12
19023	300 g	12
19024	400 g	12
19025	500 g	12
19026	600 g	6
19028	800 g	6
19030	1000 g	6
19031	1500 g	6
19032	2000 g	1



**FESTA**

**PALICE FIBERGLASS**

· násada fiberglass

**DIN 6475**

Č.p.	specifikace	
19066	1000 g	4
19067	1250 g	4
19068	1500 g	4
19069	2000 g	2

**FESTA**

**PALICE FIBERGLASS**

· násada fiberglass



Č.p.	specifikace	
19034	3000 g	4
19036	4000 g	4



**FESTA**

**PALICE FIBERGLASS**

· násada fiberglass

**DIN 6475**

Č.p.	specifikace	
19070	3000 g	4
19071	4000 g	4
19058	5000 g	4
19059	6000 g	2

**FESTA****KLADIVO  
POKRÝVAČSKÉ  
FIBERGLASS**

· násada fiberglass



Č.p.	specifikace	
19061	600 g	6

**FESTA****KLADIVO  
ŠEVCOVSKÉ  
FIBERGLASS**

· násada fiberglass



Č.p.	specifikace	
19064	450 g	6

**FESTA****KLADIVO  
POKRÝVAČSKÉ  
MONOLIT**

Č.p.	specifikace	
19062	600 g	6

**FESTA****KLADIVO  
ŠEVCOVSKÉ  
MONOLIT**

Č.p.	specifikace	
19063	450 g	6

**KLADIVO  
POKRÝVAČSKÉ**

Č.p.	specifikace	
19100	600 g	6

**FESTA****KLADIVO  
ZEDNICKÉ  
MONOLIT**

Č.p.	specifikace	
19150	600 g	6

**FESTA****KLADIVO  
POKRÝVAČSKÉ**

Č.p.	specifikace	
19060	600 g	6

**FESTA****KLADIVO  
ŠEVCOVSKÉ**

Č.p.	specifikace	
19065	450 g	6

**FESTA****KLADIVO  
ZEDNICKÉ  
FIBERGLASS**

· násada fiberglass



Č.p.	specifikace	
19151	600 g	6

**FESTA****KLADIVO ZEDNICKÉ**

· jasanová násada



Č.p.	specifikace	
19149	44 mm	1

**FESTA****KLADIVO ZEDNICKÉ**

· jasanová násada



Č.p.	specifikace	
19124	24 mm	1
19136	36 mm	1
19148	48 mm	1

**FESTA****KLADIVO - SEKERA**

Č.p.	specifikace	
19303	600 g	6

## FESTA

### PALICE

Č.p.	specifikace	
19051	1000 g	6
19052	1500 g	6



### PALICE

· kruhový klín

**DIN 6475**

Č.p.	specifikace	
19053	1000 g	6
19050	1250 g	6
19054	1500 g	6
19055	2000 g	6



### KLADIVO

· kruhový klín

**DIN 1041**

Č.p.	specifikace	
19001	100 g	12
19002	200 g	12
19003	300 g	6
19004	400 g	6
19005	500 g	6
19006	600 g	6
19008	800 g	6
19010	1000 g	6
19015	1500 g	6
19020	2000 g	6



### PALICE

· kruhový klín

**DIN 6475**

Č.p.	specifikace	
19056	3000 g	6
19057	4000 g	6



### KLADIVO SVÁŘEČSKÉ



Č.p.	specifikace	
19115	320 g	1



## FESTA

### JASANOVÁ NÁSADA NA ZEDNICKÉ KLADIVO

Č.p.	specifikace	
61240	násada	1



### NÁSADA NA KLADIVO JASANOVÁ



Č.p.	specifikace	pro kladivo	
61320	26 cm	19081	10
61321	28 cm	19082	10
61322	30 cm	19083	10
61323	31 cm	19084	10
61324	32 cm	19085	10



### NÁSADA NA PALICI JASANOVÁ



Č.p.	specifikace	pro palice	
61330	80 cm	19074, 19075	10
61331	90 cm	19076, 19077	10



### KLÍNEK KRUHOVÝ KÓNICKÝ

Č.p.	specifikace	
19430	6 mm	10
19431	8 mm	10
19432	10 mm	10
19433	12 mm	10
19434	14 mm	10
19435	16 mm	10



### KLÍNEK KOVANÝ



Č.p.	specifikace	
19440	úzký	10
19441	střední	10
19442	široký	10
19443	široký S	10



## FESTA

### KLÍNEK DO TOPORA



**3x**

Č.p.	specifikace	
19398	20 x 25 x 5 mm	1
19399	30 x 40 x 5 mm	1





# FESTA



**FESTA**

## PALICE DŘEVĚNÁ

· bukové dřevo



Č.p.	specifikace	
19202	Ø 60 x 120 mm	260 g



**FESTA**

## PALICE GUMOVÁ

· jasanová násada



Č.p.	specifikace	
19245	Ø 55 mm	400 g
19246	Ø 60 mm	800 g
19247	Ø 70 mm	1000 g
19248	Ø 95 mm	2000 g
19249	Ø 115 mm	3000 g

## FESTA

### PALICE GUMOVÁ

· násada fiberglass



Č.p.	specifikace	
19270	Ø 55 mm	6
19271	Ø 65 mm	6
19272	Ø 90 mm	6



## FESTA

### PALICE GUMOVÁ



Č.p.	specifikace	
19255	Ø 55 mm	6
19265	Ø 65 mm	6
19290	Ø 90 mm	6



## FESTA

### PALICE GUMOVÁ BÍLÁ

· násada fiberglass

Č.p.	Specifikace	
19281	680g	6



## FESTA

### PALICE GUMOVÁ BÍLÁ



Č.p.	specifikace	
19293	Ø 55 mm	6
19294	Ø 65 mm	6
19295	Ø 90 mm	6



## FESTA

### PALICE MOSAZNÁ

· násada fiberglass

Č.p.	specifikace	
19211	Ø 30 mm 500 g	1



## FESTA

### PALICE NYLONOVÁ

· násada fiberglass



Č.p.	specifikace	
19209	Ø 34 mm	6



### PALICE GUMOVÁ



Č.p.	specifikace	
19251	Ø 55 mm 400 g	12
19252	Ø 65 mm 700 g	6
19253	Ø 90 mm 1300 g	4



### PALICE GUMOVÁ ČERNO-BÍLÁ



Č.p.	specifikace	
19254	Ø 65 mm	6



## FESTA

### PALIČKA S VÝMĚNNÝMI KONCI

- PP - 97 Shore A ·
- TPU - 95 Shore A ·
- TPE - 90 Shore A ·
- TPE - 90 Shore A ·
- TPU - 92 Shore A ·
- TPU - 92 Shore A ·
- TPU - 88 Shore A ·
- TPE - 90 Shore A ·

### PALICE SILIKONOVÁ

Č.p.	specifikace	
19297	Ø 30 mm	12



Č.p.	specifikace	
19208	Ø 38 mm	1

SADA  
KLEMPÍŘSKÁ

7x

Č.p. specifikace  
19110

5



## FESTA

## PÁČIDLO

Č.p. specifikace  
19420 300 mm 1

NEW

## FESTA

## PÁČIDLO

Č.p.	specifikace	
19424	400 mm	6
19425	600 mm	6
19426	800 mm	6
19427	1000 mm	6



## PÁČIDLO

Č.p.	specifikace	
19416	600 mm Ø 16 mm	4
19422	800 mm Ø 16 mm	4
19421	1000 mm Ø 18 mm	4



## PÁČIDLO

Č.p.	specifikace	
19423	380 x 35 x 6 mm	1



FESTA

VYTAHOVÁK  
PÁČIDLO

Č.p.	specifikace	
19415	300 mm Ø 15 mm	6





**FESTA**

SEKÁČ PLOCHÝ

CrV	Č.p.	specifikace	šířka hrotu	
	19406	300 mm	25 mm	5
	19407	400 mm	30 mm	5



**FESTA**

SEKÁČ ŠPIČATÝ

CrV	Č.p.	specifikace	
	19408	250 mm	5
	19409	350 mm	5



**FESTA**

SEKÁČ PLOCHÝ

CrV	Č.p.	specifikace	šířka hrotu	
	19460	300 mm	25 mm	5
	19470	400 mm	30 mm	5



SEKÁČ ŠPIČATÝ

Č.p.	specifikace	
19400	250 mm	5
19403	350 mm	6



SEKÁČ PLOCHÝ

Č.p.	specifikace	šířka hrotu	
19401	250 mm	19 mm	6
19404	350 mm	22 mm	6



SEKÁČ PLOCHÝ

Č.p.	specifikace	šířka hrotu	
19402	250 mm	50 mm	2
19405	350 mm	50 mm	6



**FESTA**

SEKÁČE, DŮLČÍKY, PRŮBOJNÍKY - SADA

12x CrV

- 2, 6, 8 mm
- 10, 12, 16 mm
- Ø 1,5-3-4-5-6-8 mm

Č.p.	specifikace	
19487		4



**FESTA**

SEKÁČE, DŮLČÍKY A PRŮBOJNÍKY - SADA

6x CrV

- 2 x 140, 8 x 115 mm
- 12 x 152, 10 x 142 mm
- Ø 3 x 152, 6 x 152 mm

Č.p.	specifikace	
19486		10



**FESTA**

SEKÁČE - SADA

3x CrV

- 10, 12, 16 mm

Č.p.	specifikace	
19485		10



**FESTA**

SEKÁČ ZÁMEČNICKÝ KŘÍŽOVÝ

CrV

Č.p.	specifikace	
19429	200 mm	1



**FESTA**

SEKÁČ PLOCHÝ

CrV

Č.p.	specifikace	šířka hrotu	
19410	200 mm	20 mm	10
19411	250 mm	25 mm	10
19412	300 mm	25 mm	10
19418	400 mm	25 mm	5
19419	500 mm	25 mm	5



SEKÁČ ZÁMEČNICKÝ PLOCHÝ

CrV

Č.p.	specifikace	šířka hrotu	
19436	200 mm	20 mm	15

**FESTA**PRŮBOJNÍKY  
SADA**CrV** **3x**

Č.p.	specifikace
19480	Ø 0,8, 1,5, 2,5 mm



10

**FESTA**DŮLČÍKY  
SADA**CrV** **3x**

Č.p.	specifikace
19481	Ø 0,8, 1,5, 2,5 mm



10

**FESTA**PRŮBOJNÍKY  
SADA**CrV** **6x**

Č.p.	specifikace
19483	Ø 3, 4, 5, 6, 7, 8 mm



5

**FESTA**

## DŮLČÍK

**CrV**

Č.p.	specifikace
19477	Ø 2,5 mm



20

**FESTA**DŮLČÍK  
AUTOMATICKÝ**CrV**

Č.p.	specifikace
19478	Ø 2,5 mm



12

**FESTA**

## PRŮBOJNÍK

**CrV**

Č.p.	specifikace
19472	Ø 4 mm 150 mm
19473	Ø 5 mm 150 mm
19474	Ø 6 mm 150 mm



1

1

1



## ŘEZAČ SKLA



Č.p.	specifikace
20350	130 mm

12



## DĚROVAČE

24690 - Ø 2,5 mm	24691 - Ø 2 mm
Ø 3 mm	Ø 2,5 mm
Ø 4 mm	Ø 3,2 mm
Ø 5 mm	Ø 4 mm
Ø 6 mm	Ø 4,8 mm
Ø 7 mm	Ø 5 mm
Ø 8 mm	Ø 6,4 mm
Ø 9 mm	Ø 8 mm
Ø 10 mm	Ø 9,5 mm
	Ø 11,1 mm
	Ø 12,7 mm
	Ø 14 mm
	Ø 15,8 mm
	Ø 19 mm
	Ø 22 mm



Č.p.	specifikace
24690	9 ks Ø 2,5 - 10 mm
24691	15 ks Ø 2 - 22 mm



10

5

## DĚROVAČE

**13x**

Č.p.	specifikace
24695	Ø 5, 6, 8, 10, 11, 13, 16, 19, 22, 25, 28, 32, 35 mm



5



## RAZNICE ČÍSLA

Č.p.	specifikace
20972	6 mm
20973	8 mm



5

5

RAZNICE  
ABECEDA

Č.p.	specifikace
20970	6 mm
20971	8 mm



5

5





SVĚRKA RYCHLOUPÍNACÍ

Č.p.	specifikace	
23625	150 mm	6
23626	300 mm	6
23628	450 mm	6
23630	600 mm	6
23632	760 mm	6



NEW



PRODLUŽOVACÍ SPOJKA PRO SVĚRKY

FESTA INDUSTRY 23625, 23626, 23628, 23630

2x



Č.p.	Specifikace	
23635		6



SVĚRKA RYCHLOUPÍNACÍ



Č.p.	specifikace	
23570	100 x 80 mm	1
23571	160 x 80 mm	1
23572	200 x 80 mm	1
23573	250 x 80 mm	1
23574	300 x 80 mm	1

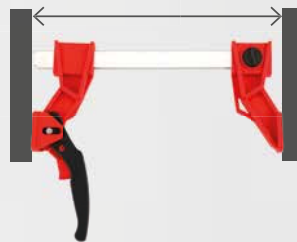

ZTUŽIDLO TRUHLÁŘSKÉ

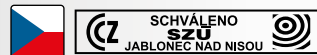

Č.p.	specifikace	
23670	150 x 105 mm	1
23671	200 x 105 mm	1
23672	250 x 105 mm	1
23673	300 x 105 mm	1
23674	350 x 105 mm	1
23675	400 x 175 mm	1
23676	500 x 175 mm	1
23677	600 x 175 mm	1
23678	700 x 175 mm	1
23679	800 x 175 mm	1
23680	1000 x 175 mm	1
23681	1250 x 175 mm	1
23682	1500 x 175 mm	1
23683	1750 x 175 mm	1
23684	2000 x 175 mm	1
23685	2200 x 175 mm	1



SVĚRKA RYCHLOUPÍNACÍ

Č.p.	specifikace	
23585	150 mm	6
23587	300 mm	6
23589	450 mm	6
23591	600 mm	6



**FESTA**

**SVĚRKA RYCHLOUPÍNACÍ**

· kovaná



Č.p.	specifikace	
23560	200 x 80 mm	1
23561	300 x 100 mm	1
23562	400 x 100 mm	1
23563	500 x 120 mm	1
23564	600 x 120 mm	1
23565	800 x 120 mm	1
23566	1000 x 120 mm	1



**SVĚRKA**

**DIN 5117**

Č.p.	specifikace	
23506	300 x 120 mm	10
23507	500 x 120 mm	10
23508	800 x 120 mm	6



**SVĚRKA**

Č.p.	specifikace	
23515	150 x 50 mm	50
23520	200 x 50 mm	50
23525	250 x 50 mm	50
23530	300 x 50 mm	50
23531	300 x 120 mm	20
23551	500 x 120 mm	10



**NEW**



**NEW**



**FESTA**

**SVĚRKA PRO PRACOVNÍ STOLY**



max. 250 mm



**FESTA**

**SVĚRKA PRO PRACOVNÍ STOLY**



Č.p.	Specifikace	
23595	250/ Ø 20 mm 60 kg	1
23598	120/ Ø 20 mm 70 kg	1

**NEW**



**FESTA**

**SVĚRKA NA RÁMY 4x UPÍNACÍ ČELISTI**

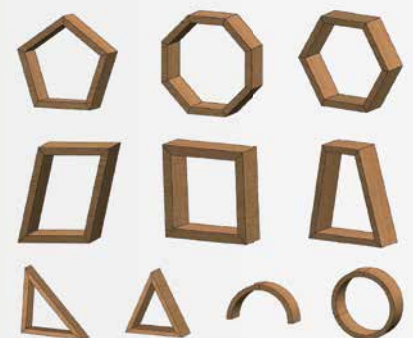

Č.p.	Specifikace	
23637	4m x 25mm	1



## FESTA

### SVĚRKA ROHOVÁ 90°



4x

Č.p.	specifikace
23607	upínací síla - 250 N



1

ALU

rozsah 0 - 65 mm

Č.p.	specifikace
23420	65 mm



20



### SVĚRKA SE ZUBOVOU POJISTKOU

rozteč 80 mm

Č.p.	specifikace
23605	9'   230 mm



### SVĚRKA PLASTOVÁ

Č.p.	specifikace
23600	4', rozteč 40 mm
23601	6', rozteč 70 mm
23602	9', rozteč 100 mm



### G' SVĚRKY SADA

Č.p.	specifikace
23620	25 mm, 50 mm, 75 mm



# FESTA



208

PRACOVNÍ STOLY



212

SVĚŘÁKY



213

HYDRAULICKÉ ZVEDÁKY



218

SVÍTILNY



220

UPÍNACÍ POPRUHY



224

LEPÍCÍ A MASKOVACÍ PÁSKY



227

KARABINY, ŘETĚZY A  
OCELOVÉ LANA

230

OCHRANNÉ POMŮCKY



234

NÁŘAĐOVÉ PÁSKY, BRAŠNY A  
POUZDRA

237

ZÁMKY, VISACÍ A  
ZÁMKY NA KOLA

239

POKLADNY A POŠTOVNÍ  
SCHRÁNKY

DÍLNA

208 - 243



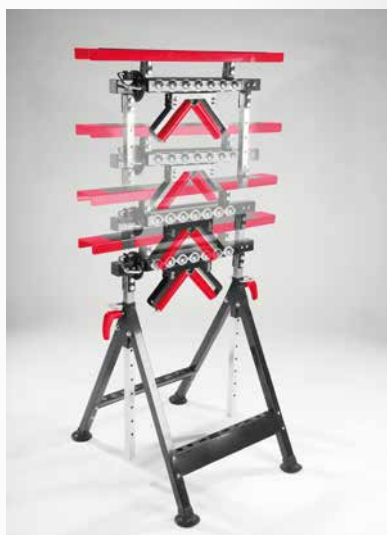

max 200 kg



max 45 kg



max 100 kg



max 100 kg

**FESTA****KOZA SKLÁDACÍ 4V1**

· maximální nosnost: 200 kg

Č.p. Specifikace

36410



1

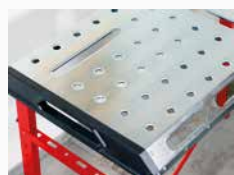

1

**FESTA****STŮL KOVOVÝ SKLÁDACÍ**

· maximální nosnost: 450 kg

Č.p. Specifikace

23652

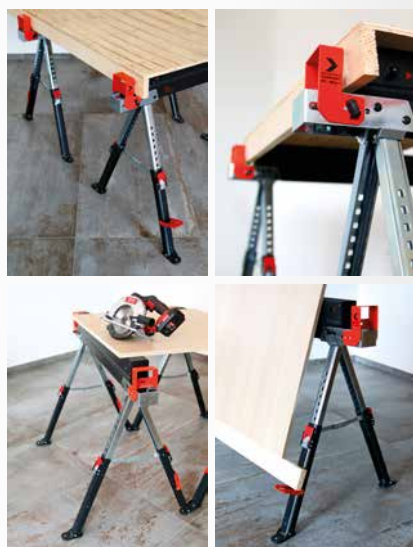

1

**FESTA****KOZA STAVEBNÍ**

· maximální nosnost: 590 kg

Č.p. Specifikace

23657



NEW



2x



4x

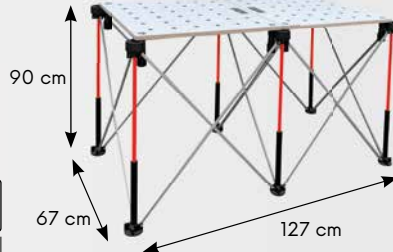
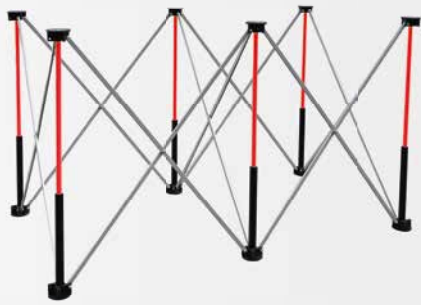

1

FESTA

PRACOVNÍ  
STONOŽKA 3x2

- 1270 x 670 x 900 mm
- maximální nosnost: 1100 kg

Č.p. Specifikace

23661

NEW



8x

FESTA

PRACOVNÍ DESKA  
PRO STONOŽKU 3x2

- 1200 x 600 x 18 mm

Č.p. Specifikace

23664



1



FESTA

## KOZA SKLÁDACÍ

- maximální nosnost: 230 kg

Č.p. Specifikace

23658



1

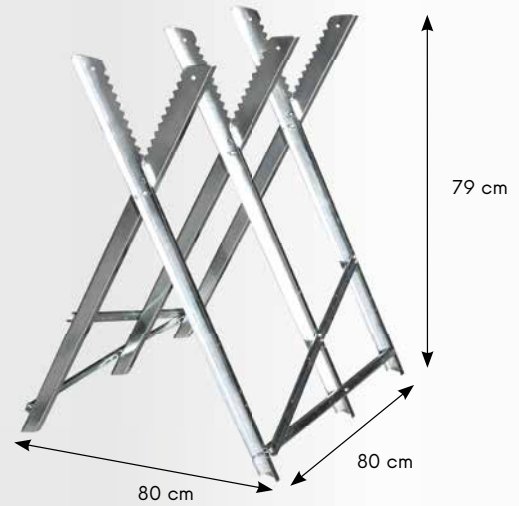

## KOZA NA ŘEZÁNÍ DŘEVA

- maximální nosnost: 150 kg

Č.p. Specifikace

37570



1



## PODPĚRA STAVEBNÍ

- maximální nosnost: 125 kg

Č.p. specifikace

36300



1



## KOZA PLASTOVÁ, SKLÁDACÍ

- max. nosnost 150 kg (300 kg v páru)

2x

Č.p. specifikace

37560



1



### KOZA SKLÁDACÍ

· max. nosnost 125 kg

2x

Č.p. specifikace  
37549 pár



1

### PRACOVNÍ STŮL SKLÁDACÍ

· max. 100 kg

Č.p. Specifikace  
23655 100 x 50 x 84 cm



1



### STŮL PRACOVNÍ

· ideální do sklepních kójí

Č.p. specifikace  
23660



1



### STŮL PRACOVNÍ MULTIFUNKČNÍ

· maximální nosnost: 100 kg

Č.p. specifikace  
23650



1



### MONTÁŽNÍ SEDÁTKO

· čalouněné pojízdné sedátko  
s plastovou odkládací přihrádkou

Č.p. Specifikace  
26988 360 x 365 x 365 mm



1

**FESTA**

### DRŽÁK MAGNETICKÝ



Č.p. specifikace  
70098



12

**FESTO****VOZÍK NA NÁŘADÍ**

Č.p.	Pojezdy zásuvek	Zásuvky	Celkové rozměry (mm)	
26986	kluzné	7	680 x 460 x 1020 mm	1

**VOZÍK NA NÁŘADÍ**

· horní skříňku lze uložit do spodního vozíku

Č.p.	specifikace	Pojezdy zásuvek	Zásuvky	Vnitřní rozměry zásuvek ŠxHxV	Celkové rozměry	Celková váha (kg)	
26985	horní skříňka	kluzné	3	151,5 x 225 x 40 mm	600 x 260 x 340 mm	11,5 kg	1
			2	511 x 225 x 40 mm			
	spodní skříňka	kluzné	1	511 x 225 x 85 mm	616 x 330 x 742 mm	16,4 kg kg	
			2	511 x 308 x 85 mm			

**FESTA****PŘENOSNÝ STOJANOVÝ SVĚŘÁK**

- rozsah čelistí: 0 - 95 cm
- maximální nosnost: 250 kg

Č.p. Specifikace

37553



1

**FESTA****SVĚŘÁK**

- tvrzené čelisti

Č.p.	specifikace		
23410	100 mm	1	
23411	125 mm	1	
23412	150 mm	1	

**SVĚŘÁK  
OTOČNÝ**

- tvrzené čelisti

Č.p.	specifikace		
23415	100 mm	1	
23416	125 mm	1	
23417	150 mm	1	

**SVĚŘÁK  
OTOČNÝ**

Č.p.	specifikace		
23407	65 mm	10	

**SVĚŘÁK  
POD VRTAČKU**

- tvrzené čelisti

Č.p.	specifikace		
23400	18   80 mm	10	
23401	22   100 mm	10	
23402	24   125 mm	5	

**SVĚŘÁK  
MODELÁŘSKÝ  
OTOČNÝ 360°  
STOLNÍ**

ALU	Č.p.	specifikace		
	23406	80 mm	24	



## HYDRAULICKÝ ZVEDÁK, JEDNOPÍSTOVÝ

- stavitelný šroub umožňuje jemné nastavení výšky a maximální zdvih
- dvojitý bezpečnostní přepouštěcí ventil
- velká vroubkovaná dosedací plocha pro bezpečné podepření
- široká základna zajišťuje stabilitu a odolnost
- všechny silně namáhané body jsou zesílené pro zvýšení odolnosti a životnosti



Č.p.	nosnost	min výška	zdvih	jemné nastavení výšky	rozměry základny	váha	
26800	2 000 kg	181mm	116 mm	48 mm	88 x 92 mm	2,6 kg	1
26801	3 000 kg	194 mm	118 mm	60 mm	92 x 100 mm	3,3 kg	1
26802	5 000 kg	216 mm	127 mm	70 mm	96 x 112 mm	4,5 kg	1
26803	8 000 kg	230 mm	147 mm	80 mm	103 x 118 mm	5,7 kg	1
26804	10 000 kg	230 mm	150 mm	80 mm	110 x 123 mm	6,8 kg	1
26805	12 000 kg	230 mm	155 mm	80 mm	116 x 134 mm	7,3 kg	1
26806	15 000 kg	230 mm	150 mm	80 mm	133 x 136 mm	8,4 kg	1
26807	20 000 kg	242 mm	150 mm	60 mm	144 x 152 mm	11 kg	1



## HYDRAULICKÝ ZVEDÁK, DVOUPÍSTOVÝ

- stavitelný šroub umožňuje jemné nastavení výšky a maximální zdvih.
- dvojitý bezpečnostní přepouštěcí ventil.
- velká vroubkovaná dosedací plocha pro bezpečné podepření.
- široká základna zajišťuje stabilitu a odolnost.
- všechny silně namáhané body jsou zesílené pro zvýšení odolnosti a životnosti.



Č.p.	nosnost	min. výška	zdvih	jemné nastavení výšky	váha	
26815	2 000 kg	150 mm	160 mm	60 mm	4,7 kg	1
26816	4 000 kg	160 mm	170 mm	60 mm	6,4 kg	1
26817	6 000 kg	215 mm	270 mm	-	8,9 kg	1
26819	10 000 kg	228 mm	284 mm	89 mm	10,2 kg	1



## NŮŽKOVÝ ZVEDÁK



Č.p.	nosnost	min výška	max výška	váha	
26844	1 000 kg	88 mm	380 mm	2,5 kg	1
26845	2 000 kg	120 mm	395 mm	3,5 kg	1



## HYDRAULICKÝ POJÍZDNÝ ZVEDÁK



Č.p.	specifikace	nosnost	min výška	max výška	váha	
26820	hydraul. zvedák pojízdný, přenosný	2 000 kg	130 mm	345 mm	9,6 kg	1
26822	hydraul. zvedák pojízdný, přenosný	3 000 kg	130 mm	465 mm	27,4 kg	1
26826	hydraul. zvedák pojízdný, nízký profil, 360° otoč. madlo	2 000 kg	89 mm	359 mm	14,2 kg	1
26824	hydraul. zvedák pojízdný, dílenský, nožní pedál	3 000 kg	145 mm	500 mm	37,2 kg	1
26825	hydraul. zvedák pojízdný, dílenský, nízký profil, profi	2 500 kg	85 mm	455 mm	34,8 kg	1

## HYDRAULICKÝ POJÍZDNÝ ZVEDÁK + PODPĚRY

· ovládací tyč otočná o 360°



Č.p.	nosnost	min výška	max výška	váha	
26829	2 000 kg	130 mm	350 mm	10,5 kg	1
	2 000 kg	275 mm	420 mm	5 kg (pár)	

## STAVITELNÁ PODPĚRA

- 1ks = 1pár
- hřeben pro přesné nastavení výšky s dvojitým zajištěním
- masivní ocelová rukojeť
- velká dosedací plocha, silná konstrukce rámu
- litinová podpěrná část



Č.p.	specifikace	nosnost	min výška	max výška	váha	
26857	s pojistkou	2 000 kg	275 mm	420 mm	4,8 kg	1
26858	s pojistkou	3 000 kg	285 mm	425 mm	6,3 kg	1
26859	s pojistkou	6 000 kg	393 mm	593 mm	13 kg	1
26853		12 000 kg	465 mm	715 mm	28 kg	1

## HYDRAULICKÝ JEŘÁBOVÝ ZVEDÁK, SKLÁDACÍ

- pro zvedání a ukládání agregátů při jejich montáži a demontáži
- nosné rameno má několik poloh vysunutí a podle toho se také řídí nosnost jeřábu
- konstrukce ve sklopném provedení umožňuje, aby jeřáb zabíral mimo provoz malý prostor

Č.p.	nosnost	min výška	max výška	váha	
26862	2 000 kg	0	2360 mm	88 kg	1



## OPĚRNÝ DRŽÁK MOTORU

- kyvadlové zavěšení ramene držáku v závislosti na sklonu kapoty, zajišťuje vždy vyvážené a stabilní upevnění motoru

Č.p.	nosnost	délka	rozsah	váha	
26871	500 kg	1500 mm	150 mm	20,3 kg	1



## HYDRAULICKÝ ZVEDÁK PŘEVODOVKY

- snadná montáž a demontáž agregátů (motorů, převodovek, náprav apod.)

Č.p.	specifikace	nosnost	délka	rozsah	váha	
26880	hydraulický zvedák převodovky	500 kg	1100 mm	1900 mm	30,0 kg	1



26880

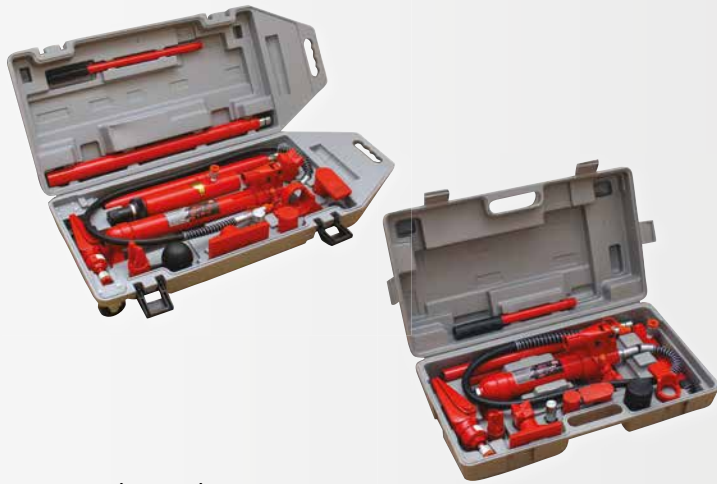

## ROZPÍNACÍ SOUPRAVA

- hydraulické zařízení pro opravování karoserií vozidel
- skládá se z hydraulického rozpínacího válce a 14ti dílů příslušenství
- široký rozsah využití při opravách karoserií osobních, dodávkových a nákladních vozidel
- především v místech, kde není možnost napojení na zdroje energie
- zařízení lze využít pro rozpínání, stlačování, zvedání a natahování ve vertikálních i horizontálních směrech
- jednoduché přenášení v plastovém kufru



Č.p.	nosnost	hydraulický zdvih	váha	
26886	4 000 kg	125 mm	17,0 kg	1
26888	10 000 kg	135 mm	32,0 kg	1



## STOJAN NA MOTOR

- pojízdný stojan pro upevnění a práci na demontovaných motorech
- univerzální upínací jednotka umožňuje jak upnutí motoru, tak jeho otáčení



Č.p.	nosnost	váha	
26920	450 kg	20 kg	1



## HYDRAULICKÁ OHÝBAČKA TRUBEK

Č.p.	zátěž	zdvih	ohýbací kolena	váha	
26895	12 000 kg	232 mm	1½", ¾", 1", 1-1¼", 1-1½", 2"	36 kg	1
26896	16 000 kg	238 mm	1½", ¾", 1", 1-1¼", 1-1½", 2", 2-1½", 3"	65 kg	1



26897

## STLAČOVAČ PRUŽIN

- 26897 - pro demontáž pružin typu mcpherson přímo na vozidle.



26943

- 26943 - pro demontáž pružin typu mcpherson mimo vozidlo masivní ocelové profily pro větší stabilitu.



Č.p.	zátěž	Ø stlač. pružiny	rozpětí stlačení	váha	
26897	1 000 kg	100-200 mm	150 mm	24,5 kg	1
26943	1 000 kg	400 mm	210-570 mm	35 kg	1



## ODSÁVAČKA VYJETÉHO OLEJE

- olej se z motoru vypouští do vypouštěcí vaničky, odkud stéká do zásobníku
- nádoba je navíc vybavena pneumatickou odsávačkou
- vyprazdňování zásobníku se provádí pneumaticky jeho připojením na stlačený vzduch



Č.p.	objem	max.tlak	váha	
26954	90 l	0,5 MPa	28 kg	1



## HYDRAULICKÝ LIS

Č.p.	rozsah	max.zátěž	váha	
26940	0 - 610 mm	12 000 kg	43 kg	1
26941	0 - 880 mm	20 000 kg	75 kg	1

## HYDRAULICKÝ VÁLEC



Č.p.	specifikace	zátěž	min.délka (mm)	max. délka (mm)	váha	
26911	jednoduchá pumpa	5 000 kg	620	1100	12 kg	2
26912	jednoduchá pumpa	8 000 kg	620	1100	13 kg	2
26914	dvojitá pumpa	5 000 kg	620	1100	12 kg	2
26915	dvojitá pumpa	8 000 kg	620	1100	14 kg	2

NÁHRADNÍ DÍLY  
K PÍSKOVACÍ KABINĚ

Č.p.	rozměry	
26973	rukavice	1
26974	trysky	1
26975	fólie 53,5 x 26 cm	1
26976	plexisklo 60 x 30 cm	1
26977	sklo 60 x 30 cm	1

## PÍSKOVACÍ KABINA 220 L

Č.p.	spotřeba vzduchu	vnější rozměry	vnitřní rozměry	max.tlak	váha	
26972	420-710 l/min.	1500 x 830 x 630 mm	600 x 840 x 630 mm	8 bar	38 kg	1

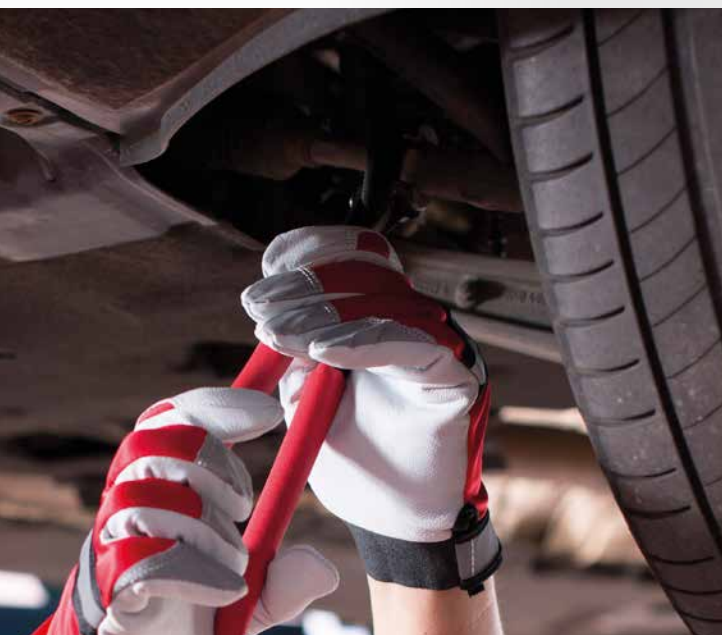

## MYČKA SOUČÁSTEK

· pro běžné mytí předmětů (součástky, díly strojů apod.)



Č.p.	objem vany	objem čistící kapaliny	Průtok	Max. teplota čistící kapaliny	váha	
26961	90 l	45 l	10-12 l/min.	50°C	25 kg	1
26963	180l	150 l	20 l/min	50°C	42 kg	1



## OLEJNIČKA

Č.p.	specifikace	
50020	300 ml	10



## MAZNICE

· přímé plnění  
· plnění kartuší  
· plnění čerpadlem

Č.p.	specifikace	
50022	400 ml	20

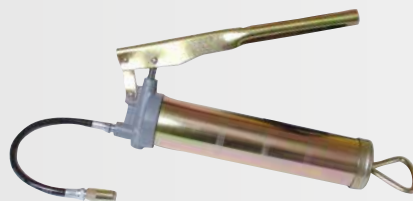

## BARELOVÁ PUMPA

Č.p.	
50017	10





## OLEJNIČKA

Č.p.	specifikace	
50019	90 ml	1



## POVOLOVAČ FILTRŮ

Č.p.	specifikace	
50021	60 x 140 mm	6



## TRYCHTÝŘ

Č.p.	specifikace	
50025	60 x 140 mm	50

HADICE PŘEČERPÁVACÍ  
SE SAMONASÁVACÍM  
VENTILEM

Č.p.	délka	Ø	
50026	180 cm	15 mm	24



## MAGNETICKÁ MISKA

Č.p.	specifikace	
26996	200 x 20 mm	1

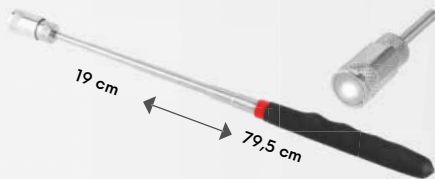

## FESTA

TELESKOP MAGNETICKÝ  
S LED OSVĚTLENÍM

Č.p.	specifikace	
13294		6

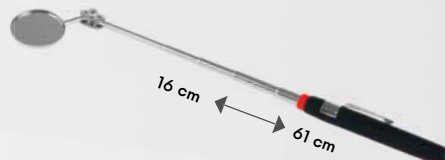
ZRCÁTKO INSPEKČNÍ  
TELESKOPICKÉ

Č.p.	specifikace	
13290		20

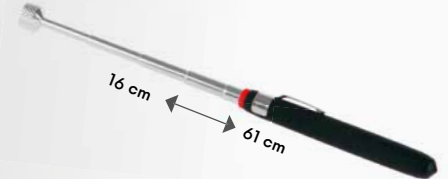

## TELESKOP MAGNETICKÝ

Č.p.	specifikace	
13293		20



## SBĚRAČ ODPADKŮ

· otočné o 90°

Č.p.	délka	
61235	81 cm	12

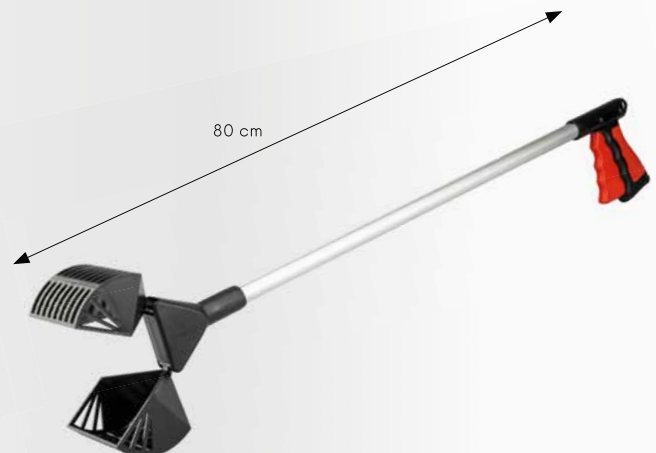

## SBĚRAČ ODPADKŮ

· max. 4 kg

Č.p.	
61236	12

# FESTA



**NEW**



80 lm



300 lm



200 lm



158 mm

301 mm

**FESTA**  
INDUSTRY

## LED SVÍTLNA VÝKLOPNÁ

3xLED	80, 200, 300 lm	3W COB LED	USB TYPE C	Li-ion 3.7V 0.8Ah	120 min
	0-180°	95g	IK07	IP54	

Č.p. 37647      Specifikace 3,7V 800 mAh

1

**FESTA****LED SVÍTELNA**

Č.p. specifikace  
37645 200 mm 3 x AAA 12

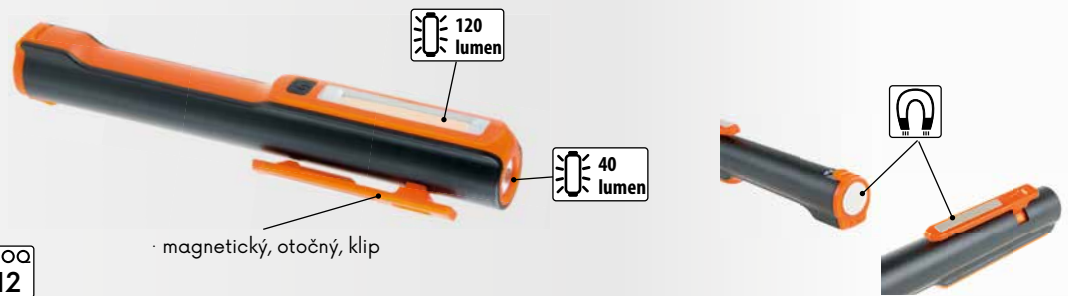
**FESTA****LED ČELOVKA**

váha	47 g
zdroj světla	1 x 1 W white LED + 2x red LED
baterie	3 x AAA
rozměry	40 x 59 x 32 mm
doba svícení	45 h
tok světla	120 lumen
dosvit	60 m (100% battery)
režimy svícení	4

5 pozic vyklopení

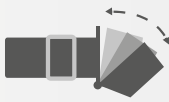

Č.p. specifikace  
37641 120 lumen + červené světlo 1

**FESTA****LED SVÍTELNA**

Č.p. specifikace  
37630 185 mm 2 x AA 20

**FESTA****LED SVÍTELNA**

Č.p. specifikace  
37650 12

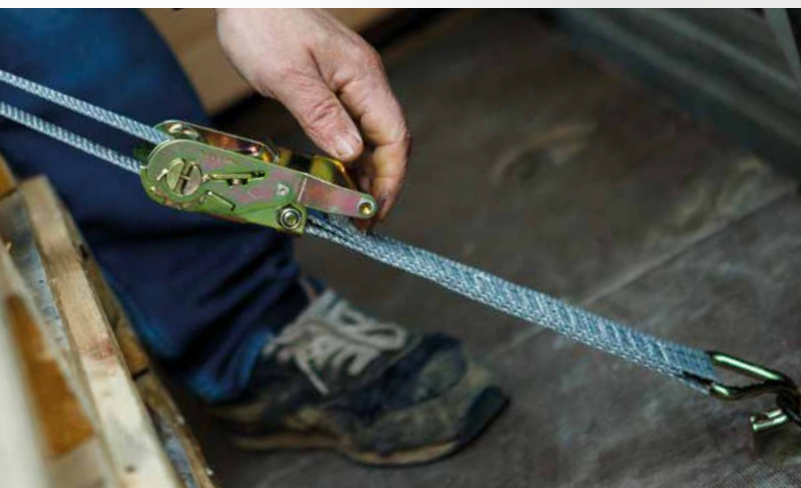

**FESTA****POPRUHY  
UPÍNACÍ  
SAMONAVÍJECÍ****2x**

Č.p.	šířka	délka	nosnost	ks	
51070	18 mm	2 m	100 kg	2	12

**FESTA****POPRUH  
UPÍNACÍ  
SAMONAVÍJECÍ**

Č.p.	šířka	délka	nosnost	ks	
51071	25 mm	3,5 m	300 kg	1	8

**FESTA****POPRUH  
UPÍNACÍ  
SAMONAVÍJECÍ**

Č.p.	šířka	délka	nosnost	ks	
51072	35 mm	4 m	500 kg	1	6

**FESTA****POPRUH  
UPÍNACÍ**

Č.p.	šířka	délka	nosnost	ks	
51040	25 mm	6 m	1000 kg	1	1
51041	35 mm	8 m	2000 kg	1	1
51042	35 mm	8 m	3000 kg	1	1
51043	50 mm	10 m	5000 kg	1	1

**FESTA****POPRUHY  
UPÍNACÍ****2x**

Č.p.	šířka	délka	nosnost	ks	
51060	25 mm	5 m	750 kg	2	5

**FESTA****POPRUH  
UPÍNACÍ**

Č.p.	šířka	délka	nosnost	ks	
51065	50 mm	10 m	960 kg	1	6

**FESTA****POPRUH  
UPÍNACÍ**

Č.p.	šířka	délka	nosnost	ks	
51026	75 mm	5 m	3000 kg	1	4

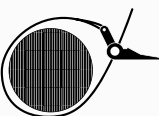
**FESTA****POPRUH  
UPÍNACÍ**

Č.p.	šířka	délka	nosnost	ks	
51032	25 mm	5 m	500 kg	1	6

**FESTA****POPRUH  
UPÍNACÍ**

Č.p.	šířka	délka	nosnost	ks	
51017	50 mm	6 m	480 kg	2	5
51018	50 mm	6 m	480 kg	1	10





## POPRUH UPÍNACÍ

Č.p.	šířka	délka	specifikace	ks
51022	25 mm	5 m	s háky	40
51023	50 mm	5 m	s háky	12

## FESTA

## POPRUH UPÍNACÍ

• měkká EVA podložka

Č.p.	šířka	délka	ks
51046	38 mm	4 m	1 20



## POPRUH UPÍNACÍ

Č.p.	šířka	délka	specifikace	ks
51030	50 mm	6 m	s háky	20
51034	50 mm	8 m	s háky	10

## POPRUH UPÍNACÍ

2x

Č.p.	šířka	délka	ks
51020	25 mm	2,5 m	2 100



## POPRUH UPÍNACÍ

PE

Č.p.	šířka	délka	ks
51045	25 mm	4 m	1 50

## GUMY UPÍNACÍ NASTAVITELNÉ

2x

Č.p.	délka	Ø	ks
51013	1,2 m	8 mm	2 1



## GUMY UPÍNACÍ

2x

Č.p.	délka	ks
51008	1 m	2 25

## GUMA UPÍNACÍ S KARABINAMI

Č.p.	délka	Ø	ks
51009	1 m	10 mm	1 25



## SADA UPÍNACÍCH POPRUHŮ

8x

- 2 x 0,4 m
- 2 x 0,6 m
- 1 x 0,8 m
- 1 x 1,0 m

Č.p.	délka	Ø	ks
51011	1 m	8 mm	8 10



## GUMY UPÍNACÍ

2x

Č.p.	délka	Ø	ks
51001	80 cm	10 mm	2 50
51002	100 cm	10 mm	2 50
51003	150 cm	10 mm	2 50
51004	200 cm	10 mm	2 50



## GUMY UPÍNACÍ S HÁKY

2x

Č.p.	délka	Ø	ks
51007	1 m	8 mm	2 25

## GUMY UPÍNACÍ PAVOUK

Č.p.	délka	Ø	specifikace	ks
51010	80 cm	8 mm	8 ramen	50



## PRUŽNÁ UPEVŇOVACÍ SÍŤ S HÁKY



č.p.	délka	šířka	
51015	80 cm	120 cm	20

## LANO ELASTICKÉ



č.p.	délka	Ø	
51036	20 m	8 mm	10
51037	20 m	10 mm	6



## HÁČKY K UPÍNACÍM GUMÁM

20x

č.p.	Ø	
51038	10 mm	30



## KARABINA

ALU

MOQ  
2

č.p.	Ø	délka	
51200	6 mm	60 mm	2
51202	7 mm	70 mm	2
51201	8 mm	80 mm	2
51203	10 mm	100 mm	2



## LANO PRŮMYSLOVÉ



č.p.	délka	Ø	
50915	5 m	8 mm	1
50916	25 m	8 mm	1
50917	25 m	10 mm	1
50918	25 m	12 mm	1
50919	25 m	14 mm	1



## PROVÁZEK SILONOVÝ

č.p.	délka	Ø	
51055	80 m	1,5 mm	50
51056	50 m	2 mm	50
51057	20 m	4 mm	50



## LANO SILONOVÉ

č.p.	délka	Ø	
51050	50 m	8 mm	10
51051	50 m	10 mm	4



## MOTOUZ POLYPROPYLEN

č.p.	váha	
50905	80 g	80
50906	100 g	100
50907	200 g	50



## MOTOUZ POLYPROPYLEN

č.p.	váha	
50909	500 g (250 m)	1
50910	1000 g (500 m)	1
50911	5000 g (2500 m)	1



## MOTOUZ JUTA

č.p.	váha	
50900	80 g (61 m)	1
50901	100 g (76 m)	1
50902	200 g (153 m)	1



## ŠŇŮRA VOSKOVANÁ



č.p.	délka	Ø	
50920	50 m	1 mm	80



## ÚVAZEK PYTLOVÝ

1000x

č.p.	specifikace	
42365	1,25   100 mm	1
42366	1,25   125 mm	1
42367	1,25   140 mm	1
42368	1,25   160 mm	1



## VAZAČ PYTLŮ

č.p.	specifikace	
50052		12
50050		1



## VAZAČ ÚVAZKŮ - RÁDLOVAČKA

č.p.	specifikace	
50051		2



## PÁSKY VÁZACÍ ZELENÉ

<b>50x</b>		EN 50146 nylon	
Č.p.	délka	šířka	
23875	120 mm	4,8 mm	1



## PÁSKY VÁZACÍ BAREVNÉ

<b>100x</b>		EN 50146 nylon	
Č.p.	délka	šířka	
23880	100 mm	2,5 mm	1
23882	150 mm	2,5 mm	1
23884	200 mm	3,6 mm	1



## PÁSKY VÁZACÍ BÍLÉ

<b>50x</b>		EN 50146 nylon	
Č.p.	délka	šířka	
23850	120 mm	2,5 mm	1
23854	200 mm	3,6 mm	1
23856	250 mm	3,6 mm	1
23858	250 mm	4,8 mm	1
23860	300 mm	4,8 mm	1
23864	400 mm	4,8 mm	1
23866	500 mm	4,8 mm	1
23868	400 mm	7,6 mm	1
23870	500 mm	7,6 mm	1



## PÁSKY VÁZACÍ ČERNÉ

<b>50x</b>		EN 50146 nylon	
Č.p.	délka	šířka	
23810	120 mm	2,5 mm	1
23814	200 mm	3,6 mm	1
23816	250 mm	3,6 mm	1
23818	250 mm	4,8 mm	1
23820	300 mm	4,8 mm	1
23824	400 mm	4,8 mm	1
23826	500 mm	4,8 mm	1
23828	400 mm	7,6 mm	1
23830	500 mm	7,6 mm	1



## PÁSKY VÁZACÍ S ÚCHYTEM

<b>10x</b>			
Č.p.	délka	šířka	
23865	160 mm	7,5 mm	1

FOLIE  
SMRŠŤOVACÍ

						
Č.p.	šířka	délka				
38095	500 mm	600 m	8 µm	čirá		1
38097	100 mm	150 m	20 µm	čirá		1
38096	500 mm	200 m	23 µm	černá		1

PE PYTLE NA SUŠ  
TRANSPARENTNÍ

						
Č.p.	šířka	délka	tloušťka	objem	ks	
39194	500 mm	1100 mm	0,16 mm	100 l	1	10
39196	600 mm	1200 mm	0,16 mm	110 l	1	10
39198	700 mm	1100 mm	0,16 mm	120 l	1	10
39200	500 mm	1100 mm	0,20 mm	100 l	1	10
39202	600 mm	1200 mm	0,20 mm	110 l	1	10
39204	700 mm	1100 mm	0,20 mm	120 l	1	10

PE PYTLE NA SUŠ  
ČERNÉ

						
Č.p.	šířka	délka	tloušťka	objem	ks	
39195	500 mm	1100 mm	0,16 mm	100 l	1	10
39197	600 mm	1200 mm	0,16 mm	110 l	1	10
39199	700 mm	1100 mm	0,16 mm	120 l	1	10
39201	500 mm	1100 mm	0,20 mm	100 l	1	10
39203	600 mm	1200 mm	0,20 mm	110 l	1	10
39205	700 mm	1100 mm	0,20 mm	120 l	1	10



## PYTLE NA ODPAD

						
Č.p.	šířka	délka	tloušťka		ks	
38060	700 mm	1100 mm	0,08 mm		10	1
38063	700 mm	1100 mm	0,10 mm		3	1
38065	700 mm	1100 mm	0,20 mm		3	1



## SÁČKY NA ODPAD

						
Č.p.	šířka	délka	tloušťka		ks	
38050	500 mm	600 mm	0,04 mm		25	1
38052	600 mm	800 mm	0,04 mm		25	1
38054	700 mm	1100 mm	0,04 mm		25	1

PE PYTLE  
NA ODPAD

<b>5x</b>						
Č.p.	šířka	délka	tloušťka			
38055	1200 mm	1000 mm	0,08 mm			5

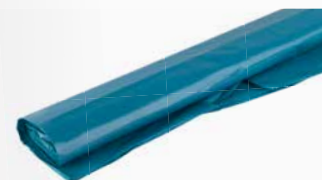



FOLIE VÝSTRAŽNÁ - EL. VEDENÍ

Č.p.	šířka	délka	
38955	22 cm	20 m	1
38956	22 cm	50 m	1



FOLIE VÝSTRAŽNÁ - VODA

Č.p.	šířka	délka	
38957	22 cm	20 m	1
38958	22 cm	50 m	1



FOLIE VÝSTRAŽNÁ - PLYN

Č.p.	šířka	délka	
38959	22 cm	20 m	1
38960	22 cm	50 m	1



PÁSKA VAROVACÍ

Č.p.	specifikace	délka	
38944	ZÁKAZ VSTUPU, SK	80 mm 250 m	8
38945	VSTUP ZAKÁZÁN, CZ	80 mm 250 m	8



PÁSKA VAROVACÍ

Č.p.	délka	
38948	80 mm 250 m	8

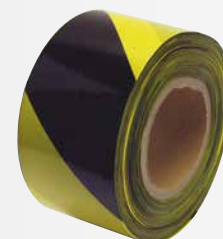

PÁSKA VAROVACÍ

Č.p.	délka	
38946	80 mm 250 m	8



PÁSKA VAROVACÍ - SAMOLEPICÍ

Č.p.	délka	specifikace	
38947	48 mm 33 m	pravá	48
38961	48 mm 33 m	levá	48



PÁSKA TRASOVACÍ

Č.p.	šířka	délka	tloušťka materiálu	
38949	50 mm	50 m	0,15 mm	36

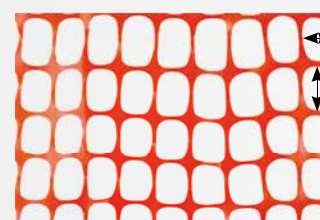

cca 3,5 cm

cca 6,5 cm

BEZPEČNOSTNÍ SÍŤ

140 g/m<sup>2</sup> UV STABLE

Č.p.	specifikace	
42190	1,2 x 50 m HDPE 140g/m <sup>2</sup>	1



PÁSKY PVC

5x

Č.p.	šířka	délka	tloušťka materiálu	
38931	19 mm	5 m	0,13 mm	100



PÁSKA PVC - ČERNÁ

Č.p.	šířka	délka	tloušťka materiálu	
38932	19 mm	10 m	0,13 mm	10



PÁSKA PVC

Č.p.	šířka	délka	tloušťka materiálu	
38925	19 mm	10 m	0,13 mm	10



PÁSKA PVC, ČERNÁ

Č.p.	šířka	délka	tloušťka materiálu	
38968	19 mm	10 m	0,19 mm	10

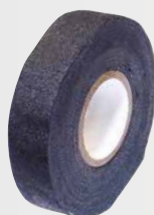

PÁSKA TEXTILNÍ ČERNÁ

Č.p.	šířka	délka	
38927	19 mm	10 m	10



PÁSKA TEXTILNÍ, KOBERCOVÁ

Č.p.	šířka	délka	
38980	48 mm	10 m	24
38981	48 mm	20 m	24



### PÁSKA LEPICÍ OBOUSTRANNÁ S VÝZTUŽÍ

Č.p.	šířka	délka	
38924	50 mm	10 m	1
38964	50 mm	25 m	1

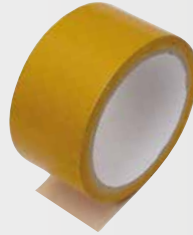

### PÁSKA LEPICÍ OBOUSTRANNÁ, POLYPROPYLEN

**PP**  
Polypropylen

Č.p.	šířka	délka	
38929	50 mm	10 m	1
38966	50 mm	25 m	1



### PÁSKA LEPICÍ OBOUSTRANNÁ MONTÁŽNÍ

MADE IN  
**EU**

Č.p.	šířka	délka	
38990	19 mm	5 m	48
38991	25 mm	5 m	36



### PÁSKA PROFESIONÁLNÍ ZESÍLENÁ, VODĚODOLNÁ

MADE IN  
**EU**

Č.p.	šířka	délka	
38995	48 mm	25 m	24



### PÁSKA TEXTILNÍ, VODĚODOLNÁ

Č.p.	šířka	délka	
38965	30 mm	10 m	1
38928	50 mm	10 m	72
38934	50 mm	45 m	24



blue dolphin tapes

### PÁSKA DUCT TAPE, VODĚODOLNÁ

MADE IN  
**EU**

Č.p.	šířka	délka	
37275	48 mm	50 m	24



blue dolphin tapes

### PÁSKA FASÁDNÍ NA OMÍTKU

UV STABLE  
MADE IN  
**EU**

Č.p.	šířka	délka	
37271	38 mm	20 m	24
37270	48 mm	20 m	24
37272	48 mm	50 m	24



blue dolphin tapes

### PÁSKA PE VENKOVNÍ OCHRANA NA OKNA

po dobu 30 dní

UV STABLE  
MADE IN  
**EU**

Č.p.	šířka	délka	
37273	48 mm	50 m	24



blue dolphin tapes

### PÁSKA PROFI PAPIŘOVÁ MASKOVACÍ

MADE IN  
**EU**

Č.p.	šířka	délka	
37263	38 mm	50 m	24
37264	48 mm	50 m	24

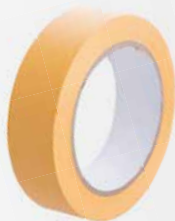

### PÁSKA PVC MASKOVACÍ

MADE IN  
**EU**

Č.p.	šířka	délka	
37266	30 mm	33 m	60
37267	38 mm	33 m	48
37268	50 mm	33 m	36



### PÁSKA PAPIŘOVÁ MASKOVACÍ

MADE IN  
**EU**

Č.p.	šířka	délka	
37255	19 mm	50 m	12
37256	25 mm	50 m	12
37257	30 mm	50 m	7
37258	38 mm	50 m	6
37259	50 mm	50 m	6



### PÁSKA BALÍCÍ PVC

MADE IN  
**EU**

Č.p.	šířka	délka	
38942	50 mm	50 m	72



### PÁSKA POKOVENÁ



Č.p.	šířka	délka	
38972	50 mm	50 m	1
38973	50 mm	100 m	1



### FÓLIE HLINÍKOVÁ SAMOLEPÍCÍ

**ALU**

Č.p.	šířka	délka	
38963	48 mm	10 m	1
38943	48 mm	45 m	24



### PÁSKA PROTISKLUZOVÁ

Č.p.	šířka	délka	tloušťka	
37280	25 mm	15 m	0,8 mm	72
37281	50 mm	15m	0,8 mm	36



### PÁSKA SAMOVULKANIZAČNÍ

Č.p.	šířka	délka	
38930	19 mm	5 m	100



### PÁSKA SÁDROKARTONÁŘSKÁ SAMOLEPÍCÍ



Č.p.	šířka	délka	
38935	50 mm	20 m	60
38937	50 mm	45 m	36
38939	50 mm	90 m	24
38940	50 mm	153 m	24



### PÁSKA SKLOVLÁKNOVÁ



Č.p.	šířka	délka	
38941	50 mm	25 m	40



### PÁSKA INSTALATÉRSKÁ TEFLONOVÁ

Č.p.	šířka	délka	tloušťka materiálu	
38969	19 mm	15 m	0,2 mm	10



### PÁSKA INSTALATÉRSKÁ TEFLONOVÁ

Č.p.	šířka	délka	tloušťka materiálu	
38933	12 mm	10 m	0,075 mm	10



### NIT TEFLONOVÁ

· na vodo, a plyn. instalace

Č.p.	šířka	délka	
38926	2 mm	150 m	20

**FESTA**
**NEW**

### NIT TĚSNICÍ ZÁVITOVÁ

 · 160m  
 · -20°C ... +130°C  
 · max 16 bar

Č.p.	Specifikace	
38975		1



### ODVÍJEČ PÁSKY

Č.p.	
38985	1



### VÁZACÍ PÁSKA, SUCHÝ ZIP

Č.p.	specifikace	
45471	12 mm x 5 m	1

**FESTA**

### PÁSKA NA SUCHÝ ZIP 3 KS

Č.p.	šířka	délka	
37295	20 mm	150 mm	1
37296	20 mm	200 mm	1
37297	20 mm	250 mm	1

## NAPÍNACÍ ŠROUB

DIN 1480 Zn



Č.p.	specifikace	
50100	5 x 70 mm	10
50101	6 x 90 mm	10
50102	8 x 125 mm	10
50103	10 x 150 mm	10

Č.p.	specifikace	
50104	12 x 200 mm	10
50106	16 x 230 mm	10
50108	20 x 220 mm	10

## KARABINA

DIN 5299 C Zn



Č.p.	specifikace	
51204	4 mm	10
51205	5 mm	10
51206	6 mm	10
51207	7 mm	10
51208	8 mm	10

Č.p.	specifikace	
51209	9 mm	10
51210	10 mm	10
51211	11 mm	10
51212	12 mm	10

## ČLÁNEK RAPID

Zn



Č.p.	specifikace	
51241	4 mm	10
51242	5 mm	10
51243	6 mm	10
51244	7 mm	10

Č.p.	specifikace	
51245	8 mm	10
51246	10 mm	10
51247	12 mm	10

## S HÁK

Zn



Č.p.	specifikace	
51271	3 mm	10
51272	4 mm	10
51273	5 mm	10
51274	6 mm	10

Č.p.	specifikace	
51275	7 mm	10
51276	8 mm	10
51278	10 mm	10

## MATICE OČKOVÁ

DIN 5820 Zn



Č.p.	specifikace	
51320	6 mm	10
51321	8 mm	10
51322	10 mm	10
51323	12 mm	10

Č.p.	specifikace	
51324	14 mm	10
51325	16 mm	10
51327	20 mm	10

## ŠROUB OČKOVÝ

DIN 5820 Zn



Č.p.	specifikace	
51300	6 mm	10
51301	8 mm	10
51302	10 mm	10
51303	12 mm	10
51304	14 mm	10

Č.p.	specifikace	
51305	16 mm	10
51306	18 mm	10
51307	20 mm	10
51308	22 mm	10



## KARABINA OTOČNÁ

Zn

Č.p.	specifikace	
51220	53 mm	10
51221	67 mm	10
51222	76 mm	10



## LANOVÁ SVĚRKA OTOČNÁ

Zn

Č.p.	specifikace	
51225	3,8 mm	10
51226	4,5 mm	10
51227	6,0 mm	10



## SPOJKA LANOVÁ

DIN 5685 C Zn

Č.p.	specifikace	
51341	Ø 10 mm	10



## SVĚRKA LANOVÁ

Zn

No.	specification	
51280	3 mm	10
51281	5 mm	10
51282	6 mm	10
51283	8 mm	10
51284	10 mm	10
51286	12 mm	10
51287	14 mm	10
51288	16 mm	10



## OČNICE PRO LANA

Zn

Č.p.	specifikace	
51258	Ø 16 mm	10
51259	Ø 18 mm	10
51260	Ø 20 mm	10
51261	Ø 22 mm	10
51262	Ø 24 mm	10
51264	Ø 28 mm	10

## ŘETĚZOVÝ ZVEDÁK

Č.p.	zátěž	min. výška	zdvih	počet kladek	síla řetězu	váha	
26700	500 kg	280 mm	3 000 mm	1	6 mm	7,5 kg	1
26701	1 000 kg	300 mm	3 000 mm	1	6 mm	9 kg	1
26702	2 000 kg	380 mm	3 000 mm	2	6 mm	12 kg	1





## NAPÍNACÍ ZAŘÍZENÍ

Č.p.	Specifikace	
50035	2 t	6
50036	4 t	4



## ŘETĚZ KRÁTKÉ OKO



DIN 5685 A Zn

Č.p.	velikost oka	délka		Č.p.	velikost oka	délka	
51402	2 x 10 mm	110 m	1	51406	6 x 24 mm	18 m	1
51403	3 x 16 mm	60 m	1	51407	7 x 50 mm	16 m	1
51404	4 x 21 mm	40 m	1	51408	8 x 32 mm	10 m	1
51405	5 x 23 mm	30 m	1	51410	10 x 39 mm	10 m	1



## ŘETĚZ UZLOVÝ



DIN 5686 Zn

Č.p.	Ø materiálu	délka		Č.p.	Ø materiálu	délka	
51430	1,4 mm	150 m	1	51433	2,0 mm	118 m	1
51431	1,6 mm	150 m	1	51435	2,5 mm	70 m	1
51432	1,8 mm	130 m	1	51436	2,8 mm	50 m	1



## ŘETĚZ DLOUHÉ OKO

DIN 5685 C Zn

Č.p.	velikost oka	délka		Č.p.	velikost oka	délka	
51412	2 x 12 mm	80 m	1	51416	6 x 43 mm	18 m	1
51413	3 x 26 mm	60 m	1	51417	7 x 50 mm	16 m	1
51414	4 x 32 mm	38 m	1	51418	8 x 54 mm	10 m	1
51415	5 x 35 mm	32 m	1	51420	10 x 65 mm	10 m	1



## ŘETĚZ PLASTOVÝ



Č.p.	specifikace	
51450	6 mm 25 m červeno-bílý	1



## NAVIJÁK S LANEM A HÁKEM

Zn

Č.p.	nosnost	délka lana	
26720	300 kg	8 m	1
26705	450 kg	8 m	1
26721	500 kg	8 m	1
26722	800 kg	8 m	1
26706	900 kg	8 m	1
26707	1350 kg	8 m	1



## STOJAN PRODEJNÍ NA LANKA A ŘETĚZY

Č.p.	specifikace	
51196	stojan na řetězy osazený	10
51197	stojan na lanka osazený	10
51198	stojan na řetězy	10
51199	stojan na lanka	10



## LANKO OCELOVÉ POZINKOVANÉ

Zn

Č.p.	průměr lana	délka	
51100	Ø 1 mm	500 m	1
51102	Ø 1,5 mm	500 m	1
51103	Ø 2 mm	200 m	1
51104	Ø 3 mm	200 m	1
51105	Ø 4 mm	100 m	1
51106	Ø 5 mm	75 m	1
51107	Ø 6 mm	75 m	1
51130	Ø 8 mm	75 m	1
51131	Ø 10 mm	50 m	1
51132	Ø 12 mm	50 m	1



## LANKO OCELOVÉ POZINKOVANÉ V PVC OBALU

Zn

Č.p.	průměr lana	délka	
51108	Ø 2/3 mm	200 m	1
51109	Ø 3/4 mm	100 m	1
51110	Ø 4/5 mm	75 m	1
51111	Ø 5/6 mm	50 m	1



## LANKO OCELOVÉ NEREZOVÉ

INOX

Č.p.	průměr lana	délka	
51120	Ø 1 mm	300 m	1
51121	Ø 1,2 mm	300 m	1
51122	Ø 1,5 mm	300 m	1
51123	Ø 2 mm	200 m	1
51124	Ø 3 mm	200 m	1
51125	Ø 4 mm	100 m	1
51126	Ø 5 mm	75 m	1
51127	Ø 6 mm	75 m	1



## TYČ ZÁVITOVÁ

DIN 975 Zn

4.8 · třída pevnosti

Č.p.	specifikace	
55040	M 4 1 m	200
55050	M 5 1 m	150
55060	M 6 1 m	100
55080	M 8 1 m	50
55100	M 10 1 m	20
55120	M 12 1 m	20
55140	M 14 1 m	15
55160	M 16 1 m	15
55180	M 18 1 m	10
55200	M 20 1 m	10
55220	M 22 1 m	5
55240	M 24 1 m	5
55300	M 30 1 m	5



## TYČ ZÁVITOVÁ NEREZOVÁ

DIN 976 INOX 4.8 · třída pevnosti

Č.p.	specifikace	
55315	M 12 1 m	20
55316	M 14 1 m	15
55317	M 16 1 m	15
55318	M 18 1 m	10
55319	M 20 1 m	10



před po



## TYČ ZÁVITOVÁ

DIN 975 4.8 · třída pevnosti

Č.p.	specifikace	
55051	M 5 1 m	150
55181	M 18 1 m	10
55201	M 20 1 m	10
55221	M 22 1 m	5



FESTA

## ODJEHLOVAČ

Ø 3 - 19 mm

1/4"

Č.p.	Specifikace	
16321		5



## MATICE

DIN 934 Zn

4.8 · třída pevnosti

Č.p.	specifikace	
55350	M 4 100 ks 1	
55351	M 5 100 ks 1	
55352	M 6 100 ks 1	
55353	M 8 100 ks 1	
55354	M 10 100 ks 1	
55355	M 12 100 ks 1	
55356	M 14 100 ks 1	
55357	M 16 100 ks 1	
55358	M 18 100 ks 1	
55359	M 20 10 ks 1	
55360	M 22 10 ks 1	
55361	M 24 10 ks 1	
55362	M 30 10 ks 1	



## PODLOŽKA

DIN 440R Zn



Č.p.	specifikace	
55331	M 5 100 ks 1	
55332	M 6 100 ks 1	
55333	M 8 100 ks 1	
55334	M 10 100 ks 1	
55335	M 12 100 ks 1	
55336	M 14 100 ks 1	
55337	M 16 100 ks 1	
55339	M 20 10 ks 1	
55340	M 22 10 ks 1	
55341	M 24 10 ks 1	
55342	M 30 10 ks 1	



FESTA

## ORGANIZÉR



Č.p.	Specifikace	
55650	375 x 290 x 67 mm	1



## VRUTY DO DŘEVA

2000x

Č.p.	specifikace	
55640	2000 ks	1



ks	obsah balení
350	3,0 x 16 mm
280	3,0 x 20 mm
220	3,0 x 25 mm
250	3,5 x 20 mm
240	3,5 x 25 mm
180	3,5 x 3, mm
280	4,0 x 16 mm
80	4,0 x 30 mm
40	4,0 x 40 mm
30	4,0 x 50 mm
25	5,0 x 50 mm
25	5,0 x 60 mm

## VRUTY DO DŘEVA + HMOŽDINKY, BOX

vruty do dřeva

ks	obsah balení
40	3,5 x 30 mm
25	4,0 x 40 mm
12	5,0 x 50 mm
8	6,0 x 60 mm

hmoždinky

ks	obsah balení
40	5 x 25 mm
25	6 x 30 mm
12	8 x 40 mm
8	10 x 50 mm

170x

Č.p.	specifikace	
55645		1



## VRUTY DO DŘEVA, BOX

ks	obsah balení
60	3,0 x 12 mm
50	3,0 x 16 mm
40	3,0 x 20 mm
50	3,5 x 20 mm
40	3,5 x 30 mm
25	4,0 x 30 mm
20	4,0 x 40 mm
15	5,0 x 50 mm
10	5,0 x 60 mm

310x

Č.p.	specifikace	
55642		1





## BRÝLE OCHRANNÉ

CE EN  
166

Č.p. specifikace 10



## BRÝLE OCHRANNÉ

CE EN  
166

Č.p. specifikace 10



## BRÝLE OCHRANNÉ

nastavitelná délka straniček

CE EN  
166

Č.p. specifikace 12



## BRÝLE OCHRANNÉ

CE EN  
170

Č.p. specifikace 12 tmavé



## BRÝLE OCHRANNÉ

CE EN  
166

Č.p. specifikace 1



## SLUCHÁTKA OCHRANNÁ

CE EN  
352 27 dB

Č.p. specifikace 1



## SLUCHÁTKA OCHRANNÁ

CE EN  
352 27 dB

Č.p. specifikace 1

ŠTÍT OCHRANNÝ  
PECE EN  
166

Č.p. specifikace 10

ŠTÍT OCHRANNÝ  
S MŘÍŽKOUCE  
EN 1731

Č.p. specifikace 10



## ZÁTKY DO UŠÍ

Č.p. specifikace 100



## ZÁTKY DO UŠÍ NA ŠŤURCE

Č.p. specifikace 100



## PŘILBA OCHRANNÁ CLIMAX

CE EN  
397 MADE IN EU

Č.p.	specifikace	
50550	modrá	30
50551	červená	30
50553	bílá	30
50554	žlutá	30



## VESTA REFLEXNÍ

CE EN  
20471

Č.p.	specifikace	
50570	oranžová	100
50571	žlutá	100



### KLEKÁTKO POJÍZDNÉ

Č.p.	specifikace	
37135		1



**FESTA**

### OCHRANA KOLEN

Č.p.	specifikace	
37145	gel	8



**FESTA**

### OCHRANA KOLEN

Č.p.	specifikace	
37140	gel	12



**FESTA**

### OCHRANA KOLEN

Č.p.	specifikace	
37144	gel	12



**FESTA**

### OCHRANA KOLEN

Č.p.	specifikace	
37143		12



**FESTA**

### OCHRANA KOLEN

Č.p.	specifikace	
37142	komfort	20



### OCHRANA KOLEN

Č.p.	specifikace	
37139	neopren	10



### OCHRANA KOLEN

Č.p.	specifikace	
37141		6





### RUKAVICE KOŽENÉ, ZESÍLENÉ

· s podšívkou v dlani



Č.p.	specifikace	
50518	velikost 11"	12



### RUKAVICE KOŽENÉ, ZESÍLENÉ

· s podšívkou v dlani



Č.p.	specifikace	
50519	velikost 10,5"	12



### RUKAVICE KOŽENÉ



Č.p.	specifikace	
50520	velikost 10,5"	12



### BAVLNĚNÉ RUKAVICE S PVC TERČÍKY

Č.p.	specifikace	
50524	velikost 10"	12



### RUKAVICE BAVLNĚNÉ MÁČENÉ V PVC



Č.p.	specifikace	
50525	velikost 10" - délka 35 cm	12



### RUKAVICE POLYESTER S PVC TERČÍKY

· s PVC terčíky

Č.p.	specifikace	
50526	velikost 10"	12



### RUKAVICE BAVLNĚNÉ MÁČENÉ V LATEXU



Č.p.	specifikace	
50522	velikost 10"	12



### RUKAVICE NYLONOVÉ MÁČENÉ V NITRILU



Č.p.	specifikace	
50533	velikost 10"	12



### RUKAVICE NYLON MÁČENÉ V LATEXOVÉ PĚŇĚ

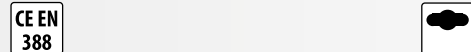

Č.p.	specifikace	
50535	velikost 8"	12
50536	velikost 9"	12
50537	velikost 10"	12



### RUKAVICE NYLON MÁČENÉ V NITRILOVÉ PĚŇĚ

· s PVC terčíky



Č.p.	specifikace	
50539	velikost 10"	12



### RUKAVICE ZIMNÍ AKRYLOVÉ MÁČENÉ V LATEXU

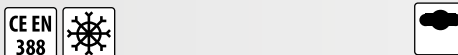

Č.p.	specifikace	
50529	velikost 10"	12



### RUKAVICE ZAHRADNÍ



Č.p.	specifikace	
50557	velikost 7"	12
50558	velikost 8"	12
50549	velikost 9"	12



### RUKAVICE BAVLNĚNÉ

· S PVC terčíky

Č.p.	specifikace	
50531	velikost 9"	12



### RUKAVICE MECHANIK, KOŽÍ KŮŽE



Č.p.	specifikace	
50541	velikost 9"	12
50542	velikost 10"	12



### RUKAVICE MECHANIK, NYLON - VEPŘOVICE



Č.p.	specifikace	
50544	velikost 10"	12



### RUKAVICE - NYLON MÁČENÉ V POLYURETANU

**CE EN  
388**

Č.p.	specifikace	
50527	velikost 10"	12



### RUKAVICE SVÁŘEČSKÉ, KOŽENÉ

**CE EN  
388** 

Č.p.	specifikace	
50540	velikost 11"	12



### RUKAVICE VINYLOVÉ JEDNORÁZOVÉ

· čiré, nepudrované

**CE**

**MOQ  
100**

Č.p.	specifikace	
50532	velikost 9"	100



### RESPIRÁTOR

**CE EN  
149**

Č.p.	specifikace	
50500	FFP2 bez ventilu	30



### RESPIRÁTOR

**CE EN  
149**

Č.p.	specifikace	
50503	FFP2 s ventilem	20



### OCHRANNÁ KOMBINÉZA S KAPUCÍ

Č.p.	specifikace	
50585	velikost M	1
50586	velikost L	1
50587	velikost XL	1
50588	velikost XXL	1

### ZÁSTĚRA NA SVÁŘOVÁNÍ



Č.p.	specifikace	
50555	kůže	1



· kvalitní kovová rukojeť, polstrovaná

· pohodlný ramenní,  
odnímatelný popruh



· popruhy se suchým zipem  
pro upevnění dlouhého nářadí

· vyztužená vnitřní konstrukce

· 18 kapes

**FESTA**

## TAŠKA NA NÁŘADÍ S KOVOVOU RUKOJETÍ

Č.p.	výška	délka	hloubka	
37331	280 mm	490 mm	230 mm	2



**FESTA**

## TAŠKA

Č.p.	šířka	výška	hloubka	
37332	480 mm	290 mm	250 mm	1

**FESTA**

## TAŠKA

Č.p.	šířka	výška	hloubka	
37330	610 mm	400 mm	270 mm	5

# FESTA



**FESTA**

## POUZDRO NÁŘAĎOVÉ

· vyztužené kapsy



Č.p.	specifikace	
37325		10



**FESTA**

## POUZDRO NÁŘAĎOVÉ

· vyztužené kapsy



Č.p.	specifikace	
37326		12



**FESTA**

## OPASEK SE SPONOU



Č.p.	specifikace	
37328	145 cm	20

**FESTA****OPASEK MONTÁŽNÍ SADA**

· 14 kapes + oko

Č.p.	délka	šířka	
37311	120 cm	6 cm	1

**FESTA****OPASEK NYLONOVÝ**

Č.p.	délka	šířka	
37310	120 cm	6 cm	1

**FESTA****POUZDRO NÁŘAĎOVÉ**

· 8 kapes

Č.p.	šířka	výška	
37320	300 mm	250 mm	1

**FESTA****POUZDRO NÁŘAĎOVÉ**

· 4 kapsy

Č.p.	šířka	výška	
37321	350 mm	300 mm	1

**FESTA****VESTA PRACOVNÍ**

Č.p.	specifikace	
37350		20

**FESTA****PÁS NÁŘAĎOVÝ KOŽENÝ**

Č.p.	specifikace	
37302	6 kapes	50
37303	11 kapes	25

**PÁS NÁŘAĎOVÝ KOŽENÝ**

Č.p.	specifikace	
37300	6 kapes	50
37301	11 kapes	25

**FESTA**



BRAŠNA KOŽENÁ  
PROFESIONÁLNÍ



Č.p.	výška	délka	hloubka	
37342	270 mm	430 mm	180 mm	1



BRAŠNA ELEKTRIKÁŘSKÁ  
KOŽENÁ



Č.p.	výška	délka	hloubka	
37341	260 mm	430 mm	200 mm	1



BRAŠNA KOŽENÁ  
S VYZTUŽENÝM DNEM



Č.p.	výška	délka	hloubka	
37340	240 mm	430 mm	150 mm	1



BRAŠNA ŘEMESLNICKÁ  
S POPRUHEM

Č.p.	výška	délka	hloubka	
37344	250 mm	300 mm	130 mm	1



BRAŠNA  
S VYZTUŽENÝM DNEM

Č.p.	výška	délka	hloubka	
37343	240 mm	430 mm	150 mm	1



BRAŠNA ELEKTRIKÁŘSKÁ

Č.p.	výška	délka	hloubka	
37345	270 mm	430 mm	180 mm	1

SPONA - KŮŽE "O"



Č.p.	specifikace
37308	20



SPONA - KŮŽE "U"



Č.p.	specifikace
37309	20



**FESTA****VLOŽKA ZÁMKU  
MOSAZNÁ**

Č.p.	specifikace	
23001	65 mm · 175 g	10

**VLOŽKA ZÁMKU  
POMOSAZENÁ**

Č.p.	specifikace	
23000	65 mm · 75 g	15

**FESTA****ZÁMEK VISACÍ**

Č.p.	specifikace	
23261	25 mm	6
23262	32 mm	12
23263	38 mm	6
23264	45 mm	6
23265	52 mm	12
23266	63 mm	6

**FESTA****ZÁMEK MOSAZNÝ  
ZESÍLENÝ**

Č.p.	specifikace	
23125	25 mm	12
23130	30 mm	12
23135	35 mm	12
23140	40 mm	12
23150	50 mm	12
23160	60 mm	12

**FESTA****ZÁMEK VISACÍ MOSAZNÝ  
POPLASTOVANÝ**

Č.p.	specifikace	
23310	30 mm	10
23311	40 mm	10
23312	50 mm	6

**FESTA****ZÁMEK VISACÍ  
PRODLOUŽENÝ**

Č.p.	specifikace	
23211	25 mm	12
23212	32 mm	12
23213	38 mm	6
23214	45 mm	6
23215	52 mm	6

**FESTA****ZÁMEK VISACÍ**

Č.p.	specifikace	
23274	60 mm	6
23275	70 mm	12

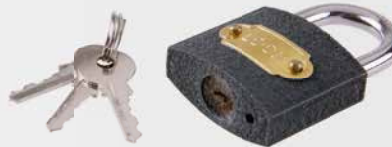
**ZÁMEK VISACÍ**

Č.p.	specifikace	
23220	25 mm	6
23225	30 mm	6
23232	32 mm	6
23240	40 mm	6
23250	50 mm	6
23260	60 mm	6

**ZÁMEK POMOSAZENÝ**

Č.p.	specifikace	
23020	20 mm	12
23025	25 mm	12
23030	30 mm	12
23035	35 mm	12
23040	40 mm	12
23050	50 mm	12
23060	60 mm	12





ZÁMEK  
VISACÍ

ZÁMEK POMŮŠAZENÝ  
PRODLOUŽENÝ



Č.p.	specifikace	
23070	40 mm	12



Č.p.	specifikace	
23010	50 mm	6



ZÁMEK  
VISACÍ



Č.p.	specifikace	
23005	40 mm	6
23006	50 mm	6



**FESTA**

ZÁMEK NA KOLO  
S ČÍSELNÝM KÓDEM



Č.p.	specifikace	
23288	120 cm x Ø 10 mm	1



**FESTA**

ZÁMEK NA KOLO  
S ČÍSELNÝM KÓDEM



Č.p.	specifikace	
23287	65 cm x Ø 10 mm	1



**FESTA**

ZÁMEK NA KOLO  
S ÚCHYTEM



Č.p.	specifikace	
23290	120 cm x Ø 8 mm	1
23291	150 cm x Ø 8 mm	1
23292	180 cm x Ø 8 mm	1



ZÁMEK NA KOLO



Č.p.	specifikace	
23282	55 cm x Ø 8 mm	50
23284	65 cm x Ø 8 mm	50



ZÁMEK VISACÍ  
S ČÍSELNÝM KÓDEM



Č.p.	
23281	20



**FESTA**

## TREZOR S ELEKTRONICKÝM ZÁMKEM

- typ zámku: elektronický, mechanický
- bezpečnostní klíč
- rozměry 350 x 250 x 250 mm
- hmotnost 10 kg



Č.p.	specifikace	
23270		1

**FESTA**

## VISAČKY KE KLÍČŮM

**100x**

- zesílený kroužek

Č.p.	
23391	50



## VISAČKY KE KLÍČŮM

**100x**

Č.p.	
23390	1



## POKLADNA

Č.p.	šířka	hloubka	výška	
70120	125 mm	95 mm	60 mm	1



## PETLICE

Č.p.	specifikace	
51514	100 mm	25
51515	120 mm	25
51516	140 mm	25
51517	160 mm	25



## ZÁSTRČ

Č.p.	specifikace	
51510	100 mm	12
51511	120 mm	12
51512	140 mm	12
51513	160 mm	12



## SCHRÁNKA NA KLÍČE

Č.p.	specifikace	
70140	250 x 180 x 80 mm - pro 48 klíčů	12
70141	300 x 230 x 90 mm - pro 90 klíčů	8

## POKLADNA

Č.p.	šířka	hloubka	výška	
70121	152 mm	118 mm	80 mm	36



## POKLADNA

Č.p.	šířka	hloubka	výška	
70122	200 mm	160 mm	90 mm	20



## POKLADNA

Č.p.	šířka	hloubka	výška	
70123	250 mm	180 mm	90 mm	16





## POKLADNA



Č.p.	šířka	hloubka	výška	
70124	300 mm	240 mm	90 mm	10



## POKLADNA



Č.p.	šířka	hloubka	výška	
70125	370 mm	280 mm	90 mm	8



## SCHRÁNKA POŠTOVNÍ



Č.p.	barva	šířka	výška	hloubka	
70101	bílá	290 mm	360 mm	105 mm	5
70100	hnědá	290 mm	360 mm	105 mm	5



## SCHRÁNKA POŠTOVNÍ



Č.p.	barva	šířka	výška	hloubka	
70102	bílá	310 mm	260 mm	90 mm	10
70103	hnědá	310 mm	260 mm	90 mm	10



## SCHRÁNKA POŠTOVNÍ



Č.p.	barva	šířka	výška	hloubka	
70105	hnědá	310 mm	360 mm	90 mm	5



## SCHRÁNKA POŠTOVNÍ



Č.p.	barva	šířka	hloubka	výška	
70108	bílá	370 mm	134 mm	364 mm	5



## SCHRÁNKA POŠTOVNÍ



Č.p.	materiál	šířka	hloubka	výška	
70107	nerez	360 mm	100 mm	520 mm	6



## SCHRÁNKA POŠTOVNÍ



Č.p.	materiál	šířka	hloubka	výška	
70106	nerez	360 mm	100 mm	360 mm	5



## SCHRÁNKA POŠTOVNÍ



Č.p.	materiál	šířka	hloubka	výška	
70109	nerez	310 mm	90 mm	260 mm	6



## SCHRÁNKA POŠTOVNÍ



Č.p.	materiál	šířka	hloubka	výška	
70110	nerez	310 mm	90 mm	360 mm	6

## MINCÍŘ ANALOGOVÝ

Č.p.	maximální nosnost		
24260	50 kg	10	



## MINCÍŘ

Č.p.	maximální nosnost	
24212	12,5 kg	12
24225	25 kg	6
24250	50 kg	6
24255	100 kg	6
24258	150 kg	6



## PINZETA S LED SVĚTLEM

Č.p.	specifikace	
50005	95 mm	8



## SADA PINZET NEREZ

Č.p.	specifikace	
50004	INOX 2x	1

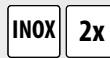

## PAST NA MYŠI

Č.p.	specifikace	
70221	90 x 45 mm dřevěná	1



## PAST NA MYŠI

Č.p.	specifikace	
70220	97 x 47 mm plastová	48



## ČISTIČ ODPADU

· možnost použití s vrtačkou

Č.p.	délka	Ø	
50014	6 m	6 mm	6



## ČISTIČ ODPADU

Č.p.	délka	
50010	3 m	10
50011	5 m	5
50012	10 m	3
50013	15 m	4



## ČISTIČ ODPADU

Č.p.	délka	Ø	
50009	3 m	5 mm	40



## PUMPA NA ČIŠTĚNÍ ODPADU

Č.p.	délka	Ø	
50015	385 mm	65 mm	30



## ELEKTRIKÁŘSKÉ PROTAHOVACÍ PERO

Č.p.	délka	Ø	
51181	8 m	5 mm	25
51182	10 m	5 mm	25





244

ZEDNICKÁ HLADÍTKA,  
LŽICE, ŠPACHTLE

250

ZEDNICKÉ NABĚRAČKY



254

ŠKRABÁKY A BRUSNÁ  
HLADÍTKA

255

HLADÍTKA A BRUSNÉ  
MRÍŽKY

257

HLADÍTKA PRO ÚPRAVU  
OMÍTEK

261

MÍCHADLA



266

STAVEBNÍ MÍCHAČKY



269

SHOZ STAVEBNÍ SUTI



269

STAVEBNÍ KOLEČKA



270

LATĚ HORIZONT



272

LÁMAČE DLAŽBY A  
NOSIČE OBRUBNÍKŮ

274

ŘEZAČKY DLAŽBY



277

POMŮCKY PRO POKLÁDÁNÍ  
DLAŽBY

280

NIVELACE



286

ŘEZAČKY NA POLYSTYREN



292

NÁŘADÍ PRO  
SÁDROKARTON

294

PB HOŘÁKY A  
REGULÁTORY TLAKU

296

ZEDNICKÉ NÁDOBY



297

VYTLAČOVACÍ PISTOLE



299

PISTOLE NA PU PĚNU



300

MALÍŘSKÉ POTŘEBY



305

PE PLACHTY



306

ŽEBŘÍKY



307

DVÍŘKA KOMÍNOVÁ A  
BEDNÍČÍ STOJKY

STAVEBNÍ NÁŘADÍ 242 - 307





# FESTO

**FESTO**

HLADÍTKO  
NEREZ  
280 X 130 MM

· gumová rukojeť



Č.p.	specifikace	
31140	rovné	10

**FESTO**

HLADÍTKO  
NEREZ  
280 X 130 MM

· gumová rukojeť



Č.p.	specifikace	
31148	rovné s oblými rohy	10

**FESTO**

HLADÍTKO  
NEREZ  
280 X 130 MM  
ZUBOVÉ

· gumová rukojeť



Č.p.	specifikace	
31146	Ø 16	10

**FESTO**

HLADÍTKO  
NEREZ  
280 X 130 MM  
ZUBOVÉ

· gumová rukojeť



Č.p.	specifikace	
31141	e 4	10
31142	e 6	10
31143	e 8	10

Č.p.	specifikace	
31144	e 10	10
31145	e 12	10

**FESTO**

HLADÍTKO  
NEREZ  
280 X 130 MM  
ZUBOVÉ



Č.p.	specifikace	
31101	e 4	10
31111	e 6	10
31121	e 8	10

Č.p.	specifikace	
31131	e 10	10
31132	e 12	10

**FESTO**

HLADÍTKO  
NEREZ  
280 X 130 MM



Č.p.	specifikace	
31091	rovné	10



**FESTA**

HLADÍTKO  
NEREZ  
280 X 130 MM

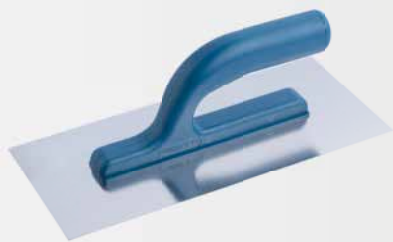

Č.p.	specifikace	
31011	rovné	10

**FESTA**

HLADÍTKO  
NEREZ  
280 X 130 MM  
ZUBOVÉ



Č.p.	specifikace	
31021	e 4	10
31031	e 6	10
31041	e 8	10

Č.p.	specifikace	
31051	e 10	10
31053	e 12	10

HLADÍTKO  
NEREZ  
270 X 125 MM



Č.p.	specifikace	
31005	rovné	25

HLADÍTKO  
NEREZ  
270 X 125 MM  
ZUBOVÉ



Č.p.	specifikace	
31006	e 4	24
31007	e 6	24

Č.p.	specifikace	
31008	e 8	24
31009	e 10	24

**FESTA**

HLADÍTKO  
NEREZ  
360 X 130 MM



Č.p.	specifikace	
31151	rovné	10

**FESTA**

HLADÍTKO  
NEREZ  
360 X 130 MM



Č.p.	specifikace	
31150	rovné	10

**FESTA**

HLADÍTKO  
NEREZ  
480 X 130 MM



Č.p.	specifikace	
31082	rovné	10

**FESTA**

HLADÍTKO  
NEREZ  
680 X 130 MM



Č.p.	specifikace	
31155	rovné	10

**FESTA**

HLADÍTKO  
NEREZ  
500 X 130 MM  
ZUBOVÉ



Č.p.	specifikace	
31052	e 4	10
31061	e 6	10
31062	e 8	10
31071	e 10	10
31072	e 12	10

**FESTA**

HLADÍTKO  
NEREZ  
500 X 130 MM



Č.p.	specifikace	
31081	rovné	10



**FESTA**

LŽÍCE NEREZ

INOX · gumová rukojeť

Č.p.	specifikace	
31232	120 mm	10
31233	140 mm	10

**FESTA**

LŽÍCE NEREZ

INOX

Č.p.	specifikace	
31220	120 x 80 mm	10
31221	140 x 80 mm	10

**FESTA**LŽÍCE NEREZ  
OBLÁ

INOX · gumová rukojeť

Č.p.	specifikace	
31334	160 x 100 mm	10

**FESTA**LŽÍCE NEREZ  
OBLÁ

INOX

Č.p.	specifikace	
31343	160 x 100 mm	10

**FESTA**LŽÍCE NEREZ  
VYMAZÁVACÍ

INOX · gumová rukojeť

Č.p.	specifikace	
31360	40 mm	10
31380	60 mm	10
31390	80 mm	10

**FESTA**LŽÍCE NEREZ  
VYMAZÁVACÍ

INOX

Č.p.	specifikace	
31362	40 mm	10
31382	60 mm	10

**FESTA**LŽÍCE NEREZ  
KOČÍČÍ JAZYK

INOX · gumová rukojeť

Č.p.	specifikace	
31330	140 x 50 mm	10
31340	160 x 60 mm	10

**FESTA**LŽÍCE NEREZ  
KOČÍČÍ JAZYK

INOX

Č.p.	specifikace	
31332	140 x 50 mm	10
31341	160 x 60 mm	10

**FESTA**LŽÍCE NEREZ  
KOUTOVÁ

INOX · gumová rukojeť

Č.p.	specifikace	
31280	80 x 60 x 60 mm	10

**FESTA**LŽÍCE NEREZ  
KOUTOVÁ

INOX

Č.p.	specifikace	
31281	80 x 60 x 60 mm	10

**FESTA**LŽÍCE NEREZ  
ROHOVÁ

INOX · gumová rukojeť

Č.p.	specifikace	
31270	80 x 60 x 60 mm	10

**FESTA**LŽÍCE NEREZ  
ROHOVÁ

INOX

Č.p.	specifikace	
31271	80 x 60 x 60 mm	10



**FESTA**

**LŽÍCE NEREZ POKRÝVAČSKÁ**

**INOX** · gumová rukojeť

Č.p.	specifikace	
31320	140 x 75 mm	10



**FESTA**

**LŽÍCE NEREZ POKRÝVAČSKÁ**

**INOX**

Č.p.	specifikace	
31322	140 x 75 mm	10



**FESTA**

**LŽÍCE NEREZ ZUBOVÁ S HRANOU**

**INOX**

Č.p.	specifikace	
31218	180 mm e 6	12



**FESTA**

**ŠPACHTLE NEREZ**

· gumová rukojeť

**INOX**

Č.p.	specifikace	
31510	40 mm	10
31511	60 mm	10
31512	80 mm	10



**FESTA**

**ŠKRABKA NEREZ**

· zesílená čepel  
· gumová rukojeť

**INOX**

Č.p.	specifikace	
32173	75 mm	10



**FESTA**

**ŠKRABKA NEREZ S TULEJÍ**

· zesílená čepel  
· vhodná násada 52010

**INOX**

Č.p.	specifikace	
32170	100 mm	12



**FESTA**

**ŠPACHTLE NEREZ S BITEM**

· gumová rukojeť

**INOX**

Č.p.	specifikace	
31455	150 mm	12
31456	200 mm	12

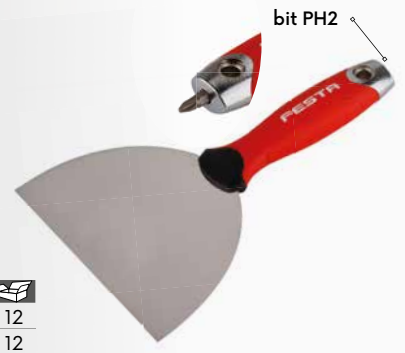

**FESTA**

**STĚRKA KOUTOVÁ, NEREZ**

**INOX**

Č.p.	specifikace	
31517		10



**FESTA**

**STĚRKA NEREZ S VÝZTUŽÍ**

· gumová rukojeť

**INOX**

Č.p.	specifikace	
31505	200 mm	5
31506	250 mm	5
31507	300 mm	5



**FESTA**

## ŠKRABKA NA STĚNY A PODLAHY

· zesílená čepel

**INOX**

Č.p.	šířka	délka	
32174	100 mm	500 mm	1

**FESTA**

## ŠPACHTLE NEREZ

**INOX**

R.s.	leírás	
31461	40 mm	12
31471	60 mm	12
31481	80 mm	12
31491	100 mm	12
31467	120 mm	12
31468	140 mm	12

**FESTA**

## ŠPACHTLE NEREZ

**INOX**

Č.p.	specifikace	
31498	150 mm	12
31499	200 mm	12
31500	100 mm	12



## ŠPACHTLE NEREZ

**INOX**

MADE IN EU

Č.p.	specifikace	
31493	40 mm	20
31494	60 mm	20
31495	80 mm	20
31496	100 mm	20



## ŠPACHTLE OCEL

R.s.	leírás	
32176	30 mm	12
32186	40 mm	12
32196	50 mm	12
32206	60 mm	12
32216	80 mm	12
32226	100 mm	12
32234	125 mm	12

ŠADA  
ŠPACHTLÍ  
OCEL**3x**

Č.p.	specifikace	
32240	30, 50, 80 mm	10

**FESTA**

## ŠPACHTLE OCEL

Č.p.	specifikace		Č.p.	specifikace	
32161	30 mm	10	32171	90 mm	10
32162	40 mm	10	32166	100 mm	10
32163	50 mm	10	32172	110 mm	10
32164	60 mm	10	32167	120 mm	10
32169	70 mm	10	32168	140 mm	10
32165	80 mm	10			



## VÁLEČEK NA NANÁŠENÍ STĚRKY

- ručka 180 mm - 52630
- ručka 250 mm - 52625
- násada 52010, 52011, 52012, 52020, 52030



Č.p.	Specifikace			
52611	250 mm	Ø 8 mm	Ø 48 mm	50
52612	180 mm	Ø 8 mm	Ø 48 mm	10

**FESTA**

ŠPACHTLE NEREZ  
PRO CELOPLOŠNÉ  
TMELENÍ

INOX

R.s.	leírás	
31555	35 cm	1
31556	45 cm	1
31557	60 cm	1
31558	80 cm	1
31559	100 cm	1



tyč univerzálně použitelná  
i pro malířské válečky



**FESTA**

DRŽÁK ŠPACHTLE  
PRO CELOPLOŠNÉ  
TMELENÍ

· pro 31555 - 31559  
· násada 52010, 52011, 52012, 52020, 52030

Č.p.	Specifikace	
31610		1



**FESTA**

TELESKOPICKÁ TYČ

· závit pro 31610, 34203

Č.p.	Specifikace	
52011	88 - 140 cm	1



ŠPACHTLE  
NEREZ  
S VÝZTUŽÍ

INOX

MADE IN EU

Č.p.	specifikace	
31520	400 mm	1
31521	500 mm	
31522	600 mm	



násada 61254



31523



31524

PŘÍSLUŠENSTVÍ KE ŠPACHTLI S VÝZTUŽÍ

MADE IN EU

Č.p.	specifikace	
31523	držák ALU	1
31524	držák plastic	1

STĚRKA  
NEREZ  
FASÁDNÍ

INOX

Č.p.	specifikace	
31552	400 mm	10
31553	600 mm	10



STĚRKA  
NEREZ

INOX

MADE IN EU

Č.p.	specifikace	
31541	250 mm	1
31551	250 mm úzká	1



## HLADÍTKO OCEĽ

Č.p.	specifikace	
32062	280 x 160 mm	10
32060	500 x 140 mm	5

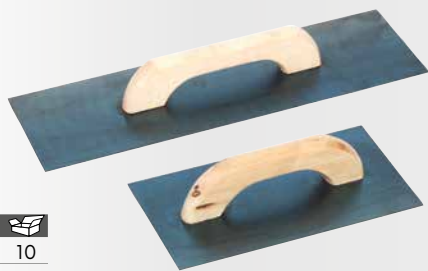

## HLADÍTKO OCEĽ ŠPIČATÉ

Č.p.	specifikace	
32064	500 x 90 mm	5
32066	550 x 140 mm	5



## LŽÍČE OCEĽ BROUŠENÁ

Č.p.	specifikace	
32015	160 x 130 mm	10
32014	180 x 130 mm	10
32016	200 x 140 mm	10



## LŽÍČE OCEĽ

Č.p.	specifikace	
32001	160 x 110 mm	10
32002	160 x 130 mm	10
32003	180 x 130 mm	10
32013	200 x 140 mm	10



## LŽÍČE OCEĽ OBLÁ

Č.p.	specifikace	
32018	160 x 110 mm	10



## LŽÍČE VYMAZÁVACÍ OCEĽ

Č.p.	specifikace	
32024	140 x 80 mm	12



## LŽÍČE KOČIČÍ JAZYK OCEĽ

Č.p.	specifikace	
32020	140 x 65 mm	12
32021	140 x 40 mm	12



## LŽÍČE POKRÝVAČSKÁ OCEĽ

Č.p.	specifikace	
32026	140 x 85 mm	12



## FESTA

### NABĚRAČKA ZEDNICKÁ S RUČKOU NEREZ

INOX

Č.p.	specifikace	
32285	Ø 180 mm	1



## FESTA

### NABĚRAČKA ZEDNICKÁ S RUČKOU POZINK

Zn

Č.p.	specifikace	
32265	Ø 180 mm	10



## FESTA

### NABĚRAČKA ZEDNICKÁ S RUČKOU

Č.p.	specifikace	
32273	Ø 160 mm	10
32283	Ø 180 mm	10
32293	Ø 215 mm	10



### NABĚRAČKA ZEDNICKÁ PLASTOVÁ



Č.p.	specifikace	
32270	Ø 160 mm	1



## NABĚRAČKA ZEDNICKÁ, OCEL

vhodná násada 61215

Č.p.	specifikace	
32302	Ø 180 mm	1
32313	Ø 215 mm	1
32301	Ø 235 mm	1



## NABĚRAČKA ZEDNICKÁ, OCEL S RUČKOU PRO LOPATOVOU NÁSADU

vhodná násada 61200, 61201

Č.p.	specifikace	
32268	Ø 215 mm	1
32269	Ø 235 mm	1
32296	Ø 215 mm	1



## HRÁBLO NA BETON

Č.p.	specifikace	
60100	hráblo na beton 295 x 150 mm	24
61169	hráblo s násadou 160 cm	3
61218	násada 160 cm	5



## NABĚRAČKA ZEDNICKÁ, OCEL S NÁSADOU

MOQ 3

Č.p.	specifikace	
32295	Ø 180 mm délka násady 160 cm	3
32297	Ø 215 mm délka násady 160 cm	3
32298	Ø 235 mm délka násady 160 cm	3



## DRÁŽKOVAC NA YTONG

Č.p.	specifikace	
32037	600 mm	1



## ÚHELNÍK NA POROBETON, YTONG

Č.p.	specifikace	
32038	270 x 270 x 270 mm	1



## LŽÍCE NA ZDICÍ SMĚSI - POROBETON, YTONG

Č.p.	specifikace	
32089	150 mm	1



### FESTA

## SEKÁČ PLOCHÝ

CrV	Č.p.	specifikace	šířka hrotu	
	19406	300 mm	25 mm	5
	19407	400 mm	30 mm	5



### FESTA

## SEKÁČ ŠPIČATÝ

CrV	Č.p.	specifikace	
	19408	250 mm	5
	19409	350 mm	5



### FESTA

## SEKÁČ PLOCHÝ

CrV	Č.p.	specifikace	šířka hrotu	
	19460	300 mm	25 mm	5
	19470	400 mm	30 mm	5



## SEKÁČ ŠPIČATÝ

Č.p.	specifikace	
19400	250 mm	5
19403	350 mm	6



## SEKÁČ PLOCHÝ

Č.p.	specifikace	šířka hrotu	
19401	250 mm	19 mm	6
19404	350 mm	22 mm	6



## SEKÁČ PLOCHÝ

Č.p.	specifikace	šířka hrotu	
19402	250 mm	50 mm	2
19405	350 mm	50 mm	6



**FESTA**MULTIFUNKČNÍ  
ŠPACHTLE**INOX**

Č.p.	specifikace
31519	75 mm



10

ŠPACHTLE NEREZ  
MALÍŘSKÁ**INOX**

Č.p.	specifikace
31497	63 x 195 mm

12

**FESTA**NŮŽ NEREZ  
TAPETÁŘSKÝ**INOX**

Č.p.	specifikace
31503	150 mm

12



ŠKRABÁK MALÍŘSKÝ

MADE IN  
**EU**

Č.p.	specifikace
31501	100 mm
31502	náhradní břit

30

1

ŠPACHTLE PRO  
SÁDROKARTONÁŘE**PLASTIC**

Č.p.	specifikace
34308	50 mm
34307	80 mm
34306	100 mm
34305	150 mm

20

12

10

12

HLADÍTKO PRO BRUSNOU  
MŘÍŽKU

Č.p.	specifikace
34301	230 x 105 mm
34304	235 x 80 mm

1

1

**FESTA**

HLADÍTKO PRO BRUSNOU MŘÍŽKU

Č.p.	specifikace
34200	210 x 115 mm
34201	240 x 105 mm
34202	240 x 80 mm

30

50

50

HLADÍTKO NA NÁSADU PRO  
BRUSNOU MŘÍŽKU

· násada 52030

**ALU**

Č.p.	specifikace
34203	230 x 80 mm aluminium
52030	teleskopická násada

1

12

BRUSNÉ  
MŘÍŽKY  
SADA**10x**

Č.p.	specifikace
34271	115 x 290 mm zrn. 120
34272	115 x 290 mm zrn. 100
34273	115 x 290 mm zrn. 80
34274	93 x 290 mm zrn. 120
34275	93 x 290 mm zrn. 100
34276	93 x 290 mm zrn. 80

80

80

80

80

80

80

BRUSNÉ  
MŘÍŽKY  
SADA**3x**

Č.p.	specifikace
34280	115 x 290 mm zrn. 120
34281	115 x 290 mm zrn. 100
34282	115 x 290 mm zrn. 80
34283	93 x 290 mm zrn. 120
34284	93 x 290 mm zrn. 100
34285	93 x 290 mm zrn. 80

20

20

20

20

20

20

**FESTA**

**STĚRKA JAPONSKÁ**

4x

Č.p.	specifikace	
31452	nerez 50, 80, 100, 120 mm	10
31453	ocel 50, 80, 100, 120 mm	10



**FESTA**

**STĚRKA JAPONSKÁ, PLAST**

4x

Č.p.	specifikace	
31454	50, 80, 100, 120 mm	12



**STĚRKA OCELOVÁ**

Č.p.	specifikace	
31601	180 mm - rovná	1
31602	180mm A1	1
31603	180mm A2	1
31641	180 mm - e4	1

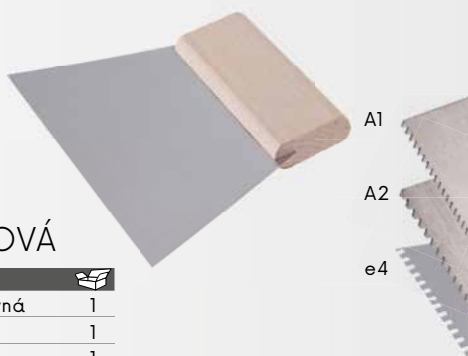

**STĚRKA OCELOVÁ**

Č.p.	specifikace	
31651	250 mm - rovná	1
31655	250 mm - e4	1

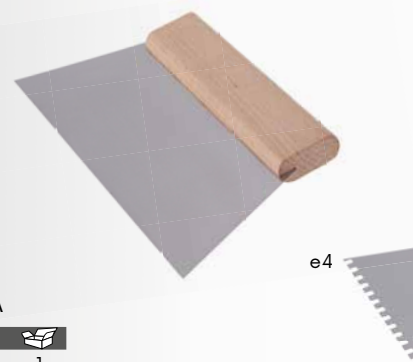

**STĚRKA PLASTOVÁ ZUBOVÁ**

Č.p.	specifikace	
37101	125 x 85 mm	100
37111	170 x 115 mm	100



**STĚRKA PLASTOVÁ**

Č.p.	specifikace	
37051	rovná	1
37031	zub - 4 x 6 mm	1
37041	zub - 6 x 6 mm	1



**LŽÍCE MODELOVACÍ OCEL**

Č.p.	specifikace	
32022	140 x 80 mm	12
32023	125 x 40 mm	12



**SPÁROVAČKA JEDNOSTRANNÁ**

Č.p.	specifikace	
32040	10 mm	20
32041	12 mm	20
32042	15 mm	20
32043	18 mm	20
32044	20 mm	20



**SPÁROVAČKA DVOUSTRANNÁ**

Č.p.	specifikace	
32050	10   12 mm	50
32051	10   15 mm	50
32052	10   18 mm	50
32053	15   20 mm	50



**FESTA**ŠKRABÁK  
NA YTONG

· topol

Č.p. specifikace  
32317 450 x 95 mmMOQ  
2**FESTA**ŠKRABÁK  
NA YTONG  
JEMNÝ ZUB

· topol

Č.p. specifikace  
32312 450 x 95 mmMOQ  
2**FESTA**ŠKRABÁK  
NA YTONG

· topol

Č.p. specifikace  
32337 260 x 95 mmMOQ  
2**FESTA**ŠKRABÁK  
NA YTONG  
JEMNÝ ZUB

· topol

Č.p. specifikace  
32338 260 x 95 mmMOQ  
2**FESTA**ŠKRABÁK  
NA BRIZOLIT

· topol

Č.p. specifikace  
32327 230 x 145 mmMOQ  
2ŠKRABÁK  
NA YTONGMADE IN  
EUČ.p. Specifikace  
32332 450 x 95 mmMOQ  
2ŠKRABÁK  
NA BRIZOLITMADE IN  
EUČ.p. Specifikace  
32333 230 x 145 mmMOQ  
2**FESTA**ŠKRABÁK  
NA ŠTARÉ  
OMÍTKYMADE IN  
EUČ.p. specifikace  
32314 400 x 180 mmMOQ  
2**FESTA**ŠKRABÁK  
NA ŠTARÉ  
OMÍTKYMADE IN  
EUČ.p. specifikace  
32329 270 x 130 mmMOQ  
2ŠKRABÁK  
NA ŠTARÉ  
OMÍTKY S OTVORYMADE IN  
EUČ.p. specifikace  
33168 380 x 160 mmMOQ  
2**FESTA**ŠKRABÁK  
NA ŠTARÉ  
OMÍTKYČ.p. specifikace  
32320 400 x 180 mmMOQ  
2

ŠKRABÁK  
NA STARÉ  
OMÍTKY



MOQ 2

Č.p.	specifikace	
32311	400 x 180 mm	2

FESTA

HLADÍTKO  
BRUSNÉ NA  
POLYSTYREN PLASTOVÉ



MOQ 2

Č.p.	specifikace	
32324	270 x 130 mm hr. 16	2
32323	270 x 130 mm hr. 16 brusný papír	10

ŠKRABÁK  
NA KAMENNOU  
VLNU

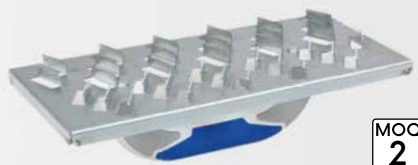

MOQ 2

Č.p.	specifikace	
32328	285 x 145 mm	10

ŠKRABÁK  
MRÍŽOVÝ

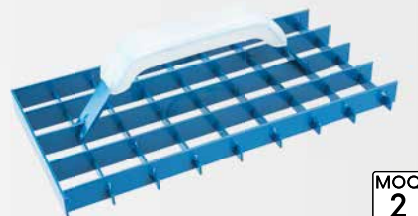

MOQ 2

Č.p.	specifikace	
32316	280 x 150 mm	20

ŠKRABÁK

· 8 břitů



MOQ 2

Č.p.	specifikace	
32326	450 x 90 mm	20

FESTA

HLADÍTKO  
PLASTOVÉ



MOQ 2

Č.p.	specifikace	
34027	400 x 180 mm	20

FESTA

HLADÍTKO  
BRUSNÉ NA  
POLYSTYREN



MOQ 2

Č.p.	specifikace	
32318	400 x 180 mm	2
32319	500 x 250 mm	2
32321	400 x 180 mm hr. 16 brusný papír	10
32322	500 x 250 mm hr. 16 brusný papír	10

FESTA

HLADÍTKO  
S LEPENÝM  
BRUSIVEM



MOQ 2

Č.p.	specifikace	
32330	400 x 180 mm	2
32331	270 x 130 mm	2

FESTA

ŠKRABÁK



MOQ 2

Č.p.	specifikace	
32325	225 x 105 mm	2

ŠKRABÁK  
MRÍŽOVÝ  
OZUBENÝ

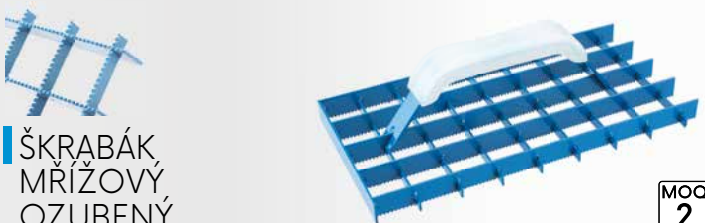

MOQ 2

Č.p.	specifikace	
32335	290 x 145 mm	2

ŠKRABÁK  
PLASTOVÝ

· 6 břitů



MOQ 2

Č.p.	specifikace	
32315	270 x 90 mm	30

HLADÍTKO  
PLASTOVÉ



MOQ 2

Č.p.	specifikace	
34028	400 x 180 mm	20

**FESTA**HLADÍTKO  
ABSMADE IN  
EU

Č.p.	specifikace	
34041	280 x 140 - 2 mm	10
34051	280 x 140 - 3 mm	10
34053	280 x 140 - 3 mm zubové - e6	10

**FESTA**HLADÍTKO  
PLAST  
BEZ POVRCHU

Č.p.	specifikace	
30003	270 x 125 mm	28
30004	235 x 115 mm	35
30005	210 x 115 mm	38
30007	210 x 60 mm	44

**FESTA**HLADÍTKO  
DŘEVĚNÉ

lipové dřevo



Č.p.	specifikace	
34005	400 x 145 mm	40
34007	290 x 145 mm	20

HLADÍTKO  
DŘEVĚNÉ

topolové dřevo

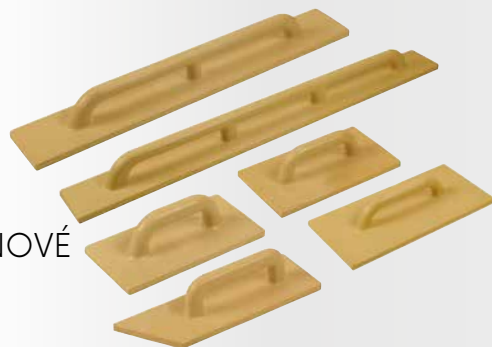

Č.p.	specifikace	
34006	400 x 145 mm	40

HLADÍTKO  
POLYURETANOVÉMADE IN  
EU

Č.p.	specifikace		Č.p.	specifikace	
34122	120 x 240 mm	50	34154	220 x 420 mm	15
34132	140 x 280 mm	40	34155	240 x 480 mm	15
34142	180 x 320 mm	25	34156	280 x 500 mm	10
34152	200 x 360 mm	20	34157	330 x 330 mm	5
34121	80 x 260 mm zkosené	50	34158	120 x 800 mm	5
34153	100 x 400 mm	30	34159	120 x 1000 mm	5
			34160	120 x 1200 mm	5

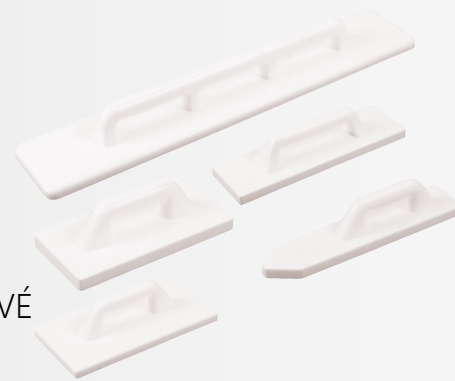
HLADÍTKO  
POLYSTYRENOVÉMADE IN  
EU

Č.p.	specifikace	
34101	80 x 350 mm zkosené	10
34061	130 x 270 mm	10
34111	170 x 320 mm	10
34071	130 x 450 mm	10
34081	140 x 750 mm	10
34091	140 x 900 mm	5

HLADÍTKO  
POLYURETANOVÉ

Č.p.	specifikace	
34115	140 x 280 mm	36
34116	180 x 320 mm	36
34117	200 x 360 mm	24

HLADÍCÍ  
DESKA  
NA BETONMADE IN  
EU

Č.p.	specifikace	
15889	980 x 380 mm násada Ø 32 mm	1

## STĚRKA S GUMOU

Č.p.	specifikace	
15886	450 mm násada Ø 23 mm	48
15887	600 mm násada Ø 23 mm	48
15888	750 mm násada Ø 23 mm	32

STAHOVACÍ  
DESKAMADE IN  
EU

Č.p.	specifikace	
15885	100 x 800 mm násada Ø 32 mm	1

MATERIÁL POVRCH	BETON		OMÍTKA			LEPIDLO A SPÁROVACÍ HMOTY	FASÁDNÍ LEPIDLO	POUŽITÍ
	HRUBÝ	POTĚROVÝ	JÁDROVÁ	JEMNÁ VNITŘNÍ	JEMNÁ YTONG			
ČERNÁ PLŠŤ (HNĚDÁ, ŠEDÁ)				••••		••		srovnání jemné omítky, na větší zrno omítek
BÍLÁ PLŠŤ				••••	••••	••••		srovnání jemné omítky, na jemnější zrno omítek
MOLITAN JEMNÝ				••••	••••	••••		odstranění volného písku, na jemný štuk (keraštuk), na omytí obkladů po spárování
MOLITAN HRUBÝ				••••	••••	••••		odstranění volného písku, na hrubý štuk
MOLITAN RASTROVANÝ				••••	••••	••••		odstranění volného písku, díky rastrování lépe zachytí hrubé části štuky, na omytí po spárování
MOŘSKÁ HOUBA					•••		••••	smytí spárovací hmoty
HYDRO HOUBA HRUBÁ, JEMNÁ					•		••••	smytí spárovací hmoty
HOUBA				••	••••	••	••••	smytí spárovací hmoty, dočištění jemné omítky, vyhlazení štukových omítek
MIKROPYŽ							••••	zatlačení spárovací hmoty do spáry
GUMOVÁ PĚNA							••••	zatlačení spárovací hmoty do spáry
MIRELON		••••	•••					zpracování betonu, zapucování jádra
DUREN				••••	••	••••		srovnání jemné omítky, všeobecně k dokončení štukových omítek
DŘEVO	••••	••••	••••					zpracování betonu, zapucování jádra
OCELOVÝ PLECH	••	••••		••		••••	••	gletování betonu, nedostupná místa
POLYSTYREN	•••	••••	•••	••		••		zpracování betonu, zapucování jádra
POLYURETAN	••••	••••	••••					zpracování betonu, zapucování jádra
ABS		••		••••	••••	••••	••••	škrabaná a točená omítka, nanášení lepidla, omítek a štuků, natahování jemné, špalety
NEREZ HLADKÉ				••••	••••	••••	••••	natahování jemné, nanášení lepidel, omítek a štuků, natahování fasádního lepidla
NEREZ ZUBATÉ							••••	natahování lepidla na obklady a dlažbu
BRUSNÉ HLADÍTKO NA POLYSTYREN, PLASTOVÉ			••				••••	broušení polystyrenu, broušení cementového lepidla
BRUSNÉ HLADÍTKO NA POLYSTYREN, PŘEKLIŽKOVÉ			••				••••	broušení fasádního polystyrenu, broušení cementového lepidla

**FESTA**HLADÍTKO PLASTOVÉ  
S BÍLOU  
PLSTÍ

Č.p.	specifikace	
34400	280 x 140 x 8 mm	15
34415	250 x 130 x 8 mm	15
34450	220 x 130 x 8 mm	15
34445	220 x 70 x 8 mm	20

**FESTA**HLADÍTKO PLASTOVÉ  
S ČERNOU  
PLSTÍ

Č.p.	specifikace	
34401	280 x 140 x 10 mm	15
34416	250 x 130 x 10 mm	15
34451	220 x 130 x 10 mm	15
34446	220 x 70 x 10 mm	20

**FESTA**HLADÍTKO PLASTOVÉ  
S JEMNÝM  
MOLITANEM

Č.p.	specifikace	
34404	280 x 140 x 30 mm	10
34485	280 x 130 x 20 mm	10
34486	250 x 130 x 30 mm	10
34419	250 x 130 x 20 mm	10
34453	220 x 130 x 20 mm	10
34447	220 x 70 x 20 mm	10

**FESTA**HLADÍTKO PLASTOVÉ  
S JEMNOU  
HOUBOU

Č.p.	specifikace	
34405	280 x 140 x 18 mm	15
34420	250 x 130 x 18 mm	15
34454	220 x 130 x 18 mm	15
34449	220 x 70 x 18 mm	20
34480	280 x 140 x 12 mm	15
34481	250 x 130 x 12 mm	15
34482	220 x 130 x 12 mm	15

**FESTA**HLADÍTKO PLASTOVÉ  
S EXTRA JEMNOU  
HOUBOU

Č.p.	specifikace	
34443	280 x 140 x 12 mm	15
34442	250 x 130 x 12 mm	15

**FESTA**HLADÍTKO PLASTOVÉ  
S HRUBOU  
HOUBOU

Č.p.	specifikace	
34441	280 x 140 x 12 mm	15
34440	250 x 130 x 12 mm	15
34439	250 x 130 x 18 mm	15



**FESTA**

HLADÍTKO PLASTOVÉ  
S RASTROVANÝM  
MOLITANEM



Č.p.	specifikace	
34409	280 x 140 x 30 mm	10
34425	250 x 130 x 20 mm	10

**FESTA**

HLADÍTKO PLASTOVÉ  
S HRUBÝM  
MOLITANEM



Č.p.	specifikace	
34410	280 x 140 x 30 mm	10
34426	250 x 130 x 20 mm	10

**FESTA**

HLADÍTKO PLASTOVÉ  
S MOŘSKOU  
HOUBOU



Č.p.	specifikace	
34406	280 x 140 x 30 mm	10
34421	250 x 130 x 30 mm	10
34455	220 x 130 x 30 mm	10

**FESTA**

HLADÍTKO PLASTOVÉ  
S MOŘSKOU  
HOUBOU,  
RASTROVANOU



Č.p.	specifikace	
34413	280 x 140 x 30 mm	10
34428	250 x 130 x 30 mm	10

**FESTA**

HLADÍTKO PLASTOVÉ  
S HYDRO  
HOUBOU  
HRUBOU



Č.p.	specifikace	
34412	280 x 140 x 30 mm	10
34424	250 x 130 x 30 mm	10
34458	220 x 130 x 30 mm	10

**FESTA**

HLADÍTKO PLASTOVÉ  
S HYDRO HOUBOU  
HRUBOU,  
RASTROVANOU



Č.p.	specifikace	
34490	280 x 140 x 30 mm	10
34491	250 x 130 x 30 mm	10

**FESTA**

HLADÍTKO PLASTOVÉ  
S HYDRO  
HOUBOU  
JEMNOU



Č.p.	specifikace	
34411	280 x 140 x 30 mm	10
34423	250 x 130 x 30 mm	10
34457	220 x 130 x 30 mm	10

**FESTA**

HLADÍTKO PLASTOVÉ  
S GUMOVOU  
PĚNOU



Č.p.	specifikace	
34402	280 x 140 x 10 mm	15
34417	250 x 130 x 10 mm	15
34452	220 x 130 x 10 mm	15

**FESTA**

HLADÍTKO PLASTOVÉ  
S MIKROPYŽÍ



Č.p.	specifikace	
34403	280 x 140 x 8 mm	15
34418	250 x 130 x 8 mm	15
34496	220 x 130 x 8 mm	15

**FESTA**

HLADÍTKO PLASTOVÉ  
S DURENEM



Č.p.	specifikace	
34407	280 x 140 x 20 mm	10
34422	250 x 130 x 20 mm	10
34456	220 x 130 x 20 mm	10
34448	220 x 70 x 20 mm	10

**FESTA**

HLADÍTKO  
PLASTOVÉ  
S RUVENEM



Č.p.	specifikace	
34414	280 x 140 x 20 mm	10
34429	250 x 130 x 20 mm	10

**FESTA**

HLADÍTKO  
PLAST  
BEZ POVRCHU



Č.p.	specifikace	
30003	270 x 125 mm	28
30004	235 x 115 mm	35
30005	210 x 115 mm	38
30007	210 x 60 mm	44

**FESTA****HLADÍTKO  
SPÁROVACÍ**MADE IN  
**EU**

Č.p.	specifikace	
34033	240 x 95 mm	5

**HLADÍTKO  
KOUTOVÉ  
S HOUBOU  
90°**

65 mm  
50 mm  
50 mm

Č.p.	specifikace	
34500	350 mm	6

**NÁHRADNÍ  
POVRCH  
BÍLÁ PLŠŤ**MADE IN  
**EU**

Č.p.	specifikace	
34241	280 x 140 x 8 mm	1
34223	250 x 130 x 8 mm	1

**NÁHRADNÍ  
POVRCH  
ČERNÁ PLŠŤ**MADE IN  
**EU**

Č.p.	specifikace	
34243	280 x 140 x 10 mm	1
34221	250 x 130 x 10 mm	1

**NÁHRADNÍ  
POVRCH  
JEMNÁ HOUBA**MADE IN  
**EU**

Č.p.	specifikace	
34262	280 x 140 x 18 mm	1

**NÁHRADNÍ  
POVRCH  
JEMNÝ MOLITAN**MADE IN  
**EU**

Č.p.	specifikace	
34251	280 x 140 x 30 mm	1

**NÁHRADNÍ POVRCH  
HRUBÝ  
MOLITAN**MADE IN  
**EU**

Č.p.	specifikace	
34261	280 x 140 x 30 mm	1

**NÁHRADNÍ POVRCH  
MOŘSKÁ  
HOUBA**MADE IN  
**EU**

Č.p.	specifikace	
34265	280 x 140 x 30 mm	1

**NÁHRADNÍ POVRCH  
HYDRO HOUBA  
HRUBÁ**MADE IN  
**EU**

Č.p.	specifikace	
34238	280 x 140 x 30 mm	1

**NÁHRADNÍ POVRCH  
HYDRO HOUBA  
JEMNÁ**MADE IN  
**EU**

Č.p.	specifikace	
34237	280 x 140 x 30 mm	1
34235	250 x 130 x 30 mm	1

**NÁHRADNÍ POVRCH  
GUMOVÁ  
PĚNA**MADE IN  
**EU**

Č.p.	specifikace	
34231	280 x 140 x 10 mm	1



**FESTA**

**ELEKTRICKÉ MÍCHADLO STAVEBNÍCH SMĚSÍ DVOUMETLOVÉ**

příkon	1800 W
napětí/frekvence	230 V / 50 Hz
rychlostní stupně	2
1. stupeň (volnoběžné otáčky)	0 - 450 ot./min.
2. stupeň (volnoběžné otáčky)	0 - 790 ot./min.
ochrana proti přetížení	Ano
průměr míchacího koše	100 mm
délka míchací metly	570 mm
hmotnost	5,6 kg



Č.p.	specifikace	
35311	míchadlo	1
35318	náhradní uhlíky	1
35319	míchadla náhradní - pár (L+P)	1



**FESTA**

**ELEKTRICKÉ MÍCHADLO STAVEBNÍCH SMĚSÍ 1600 W**

příkon	1600 W
napětí/frekvence	230 V / 50 Hz
rychlostní stupně	2
1. stupeň (volnoběžné otáčky)	0 - 480 ot./min.
2. stupeň (volnoběžné otáčky)	0 - 800 ot./min.
ochrana proti přetížení	Ano
závit míchací metly	M 14
průměr míchacího koše	140 mm
délka míchací metly	600 mm
hmotnost	4,7 kg



Č.p.	specifikace	
35310		1
35317	náhradní uhlíky	1



**FESTA**

**ELEKTRICKÉ MÍCHADLO STAVEBNÍCH SMĚSÍ 850 W**

příkon	850 W
napětí/frekvence	230 V / 50 Hz
rychlostní stupně	1
1. stupeň (volnoběžné otáčky)	0 - 500 ot./min.
2. stupeň (volnoběžné otáčky)	-
ochrana proti přetížení	Ano
závit míchací metly	M 14
průměr míchacího koše	120 mm
délka míchací metly	600 mm
hmotnost	3,7 kg

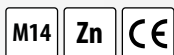

Č.p.	specifikace	
35300		1
35316	náhradní uhlíky	1



**WEST  
BERG****ELEKTRICKÉ MÍCHADLO STAVEBNÍCH SMĚSÍ 1600 W**

příkon	1600 W
napětí/frekvence	230 V / 50 Hz
rychlostní stupně	2
1. stupeň (volnoběžné otáčky)	180 - 400 ot./min.
2. stupeň (volnoběžné otáčky)	300 - 700 ot./min.
ochrana proti přetížení	Ano
závit míchací metly	M 14
průměr míchacího koše	140 mm
délka míchací metly	600 mm
hmotnost	5,4 kg

**M14 Zn CE**

Č.p.	specifikace	
35305		1
35315	náhradní uhlíky	1

**FESTA****NÁSTAVEC  
NA PRODLOUŽENÍ  
MÍCHADLA****M14**

Č.p.	Specifikace	
35142	M14	1

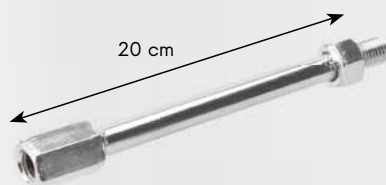
**FESTA****MÍCHADLO S KRUHEM PRAVOTOČIVÉ**

Spirálová metla se třemi rameny a kroužkem pravotočivá – pro těžké materiály s vysokou viskozitou. Malty, betony, cementové a vápenné omítky, spojovací hmoty, mazaniny, epoxidové pryskyřice, živичné vrstvy. Míchací účinek odspodu nahoru – metla se jako šroub vtažuje do materiálu.

Zn	M14	Č.p.	specifikace		
		35085	M14 Ø 120 x 600 mm	12	
		35086	M14 Ø 140 x 600 mm	12	
		35087	M14 Ø 160 x 600 mm	12	

**FESTA****MÍCHADLO S KRUHEM LEVOTOČIVÉ**

Spirálová metla se třemi rameny a kroužkem levotočivá – pro řídké tekuté směsi ve velkém množství. Míchaný materiál je tlačěn dolů. Řídký tekutý materiál nestříká z nádoby, usazené pigmenty barev se dostávají vzhůru a ideálně se promíchají.

Zn	M14	Č.p.	specifikace		
		35091	M14 Ø 120 x 600 mm	12	
		35092	M14 Ø 140 x 600 mm	12	
		35093	M14 Ø 160 x 600 mm	12	

**FESTA****MÍCHADLO S KRUHEM**

Spirálová metla se dvěma rameny – pro důkladné rozmíchání lepidel na obklady, spárovaných hmot, lepicích malt, hotových omítek, mazaniny, stěrkových hmot, vyrovnávacích hmot.

Zn	Č.p.	specifikace	
	35038	Ø 80 x 500 mm	24
	35058	Ø 100 x 500 mm	24
	35023	Ø 120 x 500 mm	24



**FESTA****MÍCHADLO S KRUHEM**

Spirálová metla se dvěma rameny – pro důkladné rozmíchání lepidel na obklady, spárovaných hmot, lepicích malt, hotových omítek, mazaniny, stěrkových hmot, vyrovnávacích hmot.

SDS+	Zn	Č.p.	specifikace	
		35094	Ø 80 x 500 mm	24
		35095	Ø 100 x 500 mm	24
		35096	Ø 120 x 500 mm	24



**FESTA****MÍCHADLO S KRUHEM**

Spirálová metla se dvěma rameny – pro důkladné rozmíchání lepidel na obklady, spárovaných hmot, lepicích malt, hotových omítek, mazaniny, stěrkových hmot, vyrovnávacích hmot.

M14	Zn	Č.p.	specifikace	
		35059	M14 Ø 90 x 550 mm	24

**FESTA****MÍCHADLO S KRUHEM, PRODLOUŽENÁ SPIRÁLA**

Spirálová metla se dvěma rameny – pro důkladné rozmíchání lepidel na obklady, spárovaných hmot, lepicích malt, hotových omítek, mazaniny, stěrkových hmot, vyrovnávacích hmot.

	Zn	Č.p.	specifikace	
		35013	Ø 80 x 500 mm	24
		35006	Ø 100 x 500 mm	24
		35007	Ø 120 x 500 mm	24

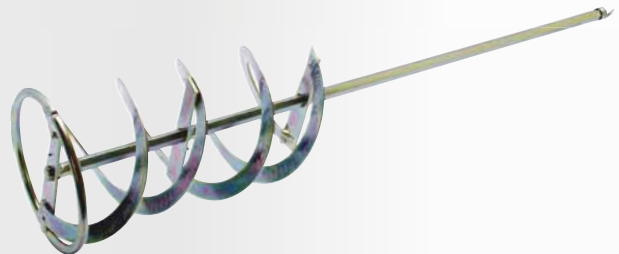

**FESTA****MÍCHADLO S KRUHEM, PRODLOUŽENÁ SPIRÁLA**

Spirálová metla se dvěma rameny – pro důkladné rozmíchání lepidel na obklady, spárovaných hmot, lepicích malt, hotových omítek, mazaniny, stěrkových hmot, vyrovnávacích hmot.

SDS+	Zn	Č.p.	specifikace		
		35012	Ø 100 x 500 mm	24	

**FESTA****MÍCHADLO SPIRÁLA DRÁT**

Spirálová metla se dvěma rameny – pro důkladné rozmíchání lepidel na obklady, spárovaných hmot, lepicích malt, hotových omítek, mazaniny, stěrkových hmot, vyrovnávacích hmot.

	Zn	Č.p.	specifikace	
		35069	Ø 60 x 500 mm	50
		35078	Ø 80 x 500 mm	24
		35081	Ø 100 x 500 mm	24

**FESTA****MÍCHADLO SPIRÁLA DRÁT**

Spirálová metla se dvěma rameny – pro důkladné rozmíchání lepidel na obklady, spárovaných hmot, lepicích malt, hotových omítek, mazaniny, stěrkových hmot, vyrovnávacích hmot.

SDS+	Zn	Č.p.	specifikace	
		35070	Ø 60 x 500 mm	50
		35079	Ø 80 x 500 mm	24
		35082	Ø 100 x 500 mm	24



**FESTA****MÍCHADLO BEZ KRUHU**

Spirálová metla se dvěma rameny – pro důkladné rozmíchání lepidel na obklady, spárovaných hmot, lepicích malt, hotových omítek, mazaniny, stěrkových hmot, vyrovnávacích hmot.

Č.p.	specifikace	
<b>Zn</b> 35048	Ø 70 x 500 mm	24
35068	Ø 90 x 500 mm	24

**FESTA****MÍCHADLO BEZ KRUHU**

Spirálová metla - pro vysoce viskózní a lepivé materiály, jako jsou stavební lepidla a tmely, omítky, podlahové stěrky a pod. Materiál proudí ode dna k hladině.

Č.p.	specifikace	
<b>Zn</b> 35021	Ø 90 x 500 mm	24

**FESTA****MÍCHADLO KALICH**

Klecová metla- pro materiály, kde je zavzdušnění směsi nežádoucí. Pro řídké vyrovnávací hmoty, stěrkové hmoty, těsnicí látky, lepidla.

Č.p.	specifikace	
<b>Zn</b> 35015	Ø 100 x 500 mm	20

**FESTA****MÍCHADLO VRTULE**

Vrtulová metla – pro tekuté materiály, barvy, laky, nástěnné a disperzní klišy na lepení tapet, lepidla na dlaždice.

Č.p.	specifikace	
<b>Zn</b> 35011	Ø 80 x 500 mm	50

**MÍCHADLO S KRUHEM**

Oblouková metla s kruhem – pro důkladné rozmíchání nástěnných barev, disperzních barev, klišů, laků.

Č.p.	specifikace	
<b>Zn</b> 35125	Ø 60 x 400 mm	40
35126	Ø 80 x 400 mm	40
35127	Ø 100 x 600 mm	20

**MÍCHADLO S KRUHEM LAKOVANÉ**

Oblouková metla s kruhem – pro důkladné rozmíchání nástěnných barev, disperzních barev, klišů, laků.

Č.p.	specifikace	
<b>Zn</b> 35103	Ø 60 x 400 mm	40
35113	Ø 80 x 400 mm	40
35123	Ø 100 x 600 mm	20



# FESTA



## PROFESIONÁLNÍ STAVEBNÍ MÍCHAČKY

**Lescha**

Stavební míchačky pro nejnáročnější profesionální použití

Zubový věnec z litiny s patentovaným uchycením

Nastavitelná vůle zubů

Vysoce kvalitní povrchová úprava

Dvojitě uložené ložiskové na dně bubny

Patentovaná ochranná izolace, kvalitativní jistění dle DIN EN ISO 9001

Speciálně vyvinutý tvar bubny

Ochrana proti stříkající vodě IP 45

Dodávané v provedení na 230V i 400V

**Lescha**  
MÍCHAČKA STAVEBNÍ

Č.p.	specifikace	
35500	Star 150 - 125 l, 230 V nožní brzda	1

**Lescha**  
MÍCHAČKA STAVEBNÍ

Č.p.	specifikace	
35502	EUROMIX 125 l, 230 V	1
35503	EUROMIX 125 l, 400 V	1

**Lescha**  
MÍCHAČKA STAVEBNÍ

Č.p.	specifikace	
35501	BX 135 - 125 l, 230 V	1

**Lescha**  
MÍCHAČKA STAVEBNÍ

Č.p.	specifikace	
35504	ABM 135 l, 230 V nožní brzda	1

**Lescha**  
MÍCHAČKA STAVEBNÍ

Č.p.	specifikace	
35505	SM 145 S - 140 l, 230 V	1
35506	SM 145 S - 140 l, 400 V	1
35507	SM 145 S - 140 l, 230 V nožní brzda	1
35508	SM 145 S - 140 l, 400 V nožní brzda	1

**Lescha**  
MÍCHAČKA STAVEBNÍ

Č.p.	specifikace	
35510	SM 165 S - 160 l, 230 V nožní brzda	1
35511	SM 165 S - 160 l, 400 V nožní brzda	1
35512	SM 165 S - 160 l, G benzínová	1

**Lescha**  
MÍCHAČKA STAVEBNÍ

Č.p.	specifikace	
35514	SM 185 S - 180 l, 230 V nožní brzda	1
35515	SM 185 S - 180 l, 400 V nožní brzda	1

**Lescha**  
MÍCHAČKA STAVEBNÍ

Č.p.	specifikace	
35516	S 180 HR - 180 l, 230 V nožní brzda	1
35517	S 180 HR - 180 l, 400 V nožní brzda	1



**Lescha**  
MÍCHAČKA STAVEBNÍ



Č.p.	specifikace	
35524	LB 354   230 V, 1,5 kW	1
35525	LB 354   400 V, 1,5 kW	1
35527	LB 354   Honda G200	1
35532	LB 404   230 V, 1,5 kW	1
35533	LB 404   400 V, 1,5 kW	1
35539	LB 484   Robin EH17B	1
35540	LB 484   Honda GX160LX	1
35542	AT 480   400 V, 1,2 kW	1

**Lescha**  
MÍCHAČKA STAVEBNÍ



Č.p.	specifikace	
35518	S 230 HR - 230 l, 230 V nožní brzda	1
35519	S 230 HR - 230 l, 400 V nožní brzda	1

**Lescha**  
MÍCHAČKA STAVEBNÍ



Č.p.	specifikace	
35552	LHB 1000   400 V	1
35553	LHB 1000   HATZ Diesel	1
35555	LHB 1200   400 V	1



**ALTRAD**  
MÍCHAČKA STAVEBNÍ



Č.p.	specifikace	
37500	MIX 130Zk 230 V rozložená	1
37501	MIX 130Z 230 V složená	1
37505	MK 165Bk 230 V rozložená	1
37506	MK 165B 230 V složená	1

**130 L**

specifikace	
objem bubnu	130 l
otáčky bubnu	26±Min <sup>-1</sup>
příkon	700 W
napětí	230 V / 50 Hz
stupeň krytí	IP44
materiál věnce	litinový
rozměry	délka 1170 mm
	šířka 650 mm
	výška 1280 mm
váha	53 kg

**165 L**

specifikace	
objem bubnu	165 l
otáčky bubnu	23±Min <sup>-1</sup>
příkon	900 W
napětí	230 V / 50 Hz
stupeň krytí	IP44
materiál věnce	litinový
rozměry	délka 1295 mm
	šířka 735 mm
	výška 1440 mm
váha	70 kg

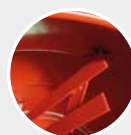

· speciálně vyrobené lopatky, tloušťka 4 mm



· kvalitní patní ložisko s krytem



· vypínač s bezpečnostní krytkou



· plastový kryt pohonu, litinový věnec

## MÍCHAČKA STAVEBNÍ



### 125 L

specifikace	
objem bubnu	125 l
otáčky bubnu	26±Min <sup>-1</sup>
příkon	550 W
napětí	230 V / 50 Hz
stupeň krytí	IP44
materiál věnce	litinový
rozměry	délka 1102 mm
	šířka 690 mm
	výška 1310 mm
váha	52,5 kg

Č.p.	specifikace		
37509	126 l, 230 V	složená	1
37510	126 l, 230 V	rozložená	1

### 162 L

specifikace	
objem bubnu	162 l
otáčky bubnu	26±Min <sup>-1</sup>
příkon	650 W
napětí	230 V / 50 Hz
stupeň krytí	IP44
materiál věnce	litinový
rozměry	délka 1180 mm
	šířka 710 mm
	výška 1310 mm
váha	56 kg

Č.p.	specifikace		
37515	162 l, 230 V	rozložená	1
37516	162 l, 230 V	složená	1



## KOLEČKO STAVEBNÍ



Č.p.	specifikace		
37530	60 l, Ø 38 cm	samonosné kolečko	1
37532	60 l, Ø 40 cm	nafukovací	1

### 142 L

specifikace	
objem bubnu	142 l
otáčky bubnu	26±Min <sup>-1</sup>
příkon	650 W
napětí	230 V / 50 Hz
stupeň krytí	IP44
materiál věnce	litinový
rozměry	délka 1164 mm
	šířka 690 mm
	výška 1293 mm
váha	54 kg

Č.p.	specifikace		
37511	142 l, 230 V	rozložená	1
37512	142 l, 230 V	složená	1

### 180 L

specifikace	
objem bubnu	180 l
otáčky bubnu	26±Min <sup>-1</sup>
příkon	850 W
napětí	230 V / 50 Hz
stupeň krytí	IP44
materiál věnce	litinový
rozměry	délka 1164 mm
	šířka 690 mm
	výška 1368 mm
váha	58 kg

Č.p.	specifikace		
37517	180 l, 230 V	rozložená	1
37518	180 l, 230 V	složená	1



## KOLEČKO STAVEBNÍ POZINK



Č.p.	specifikace		
37527	80 l, Ø 40 cm	nafukovací	1
37533	80 l, Ø 38 cm	samonosné kolečko	1

KORBA  
ČERNÁ

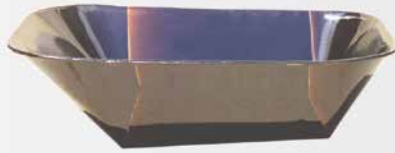

Č.p.	specifikace	
37539	60 l	1

KORBA  
POZINK



Č.p.	specifikace	
37541	80 l	1

NÁHRADNÍ  
KOLA



Č.p.	specifikace	
48729	typ AA 400 nafukovací	1
48730	typ AA 380 samonosné	1
48731	typ AA 380 samonosné	1

JAPONKA STAVEBNÍ  
TRÍKOLÁ



Č.p.	specifikace	
37564	60 l	1

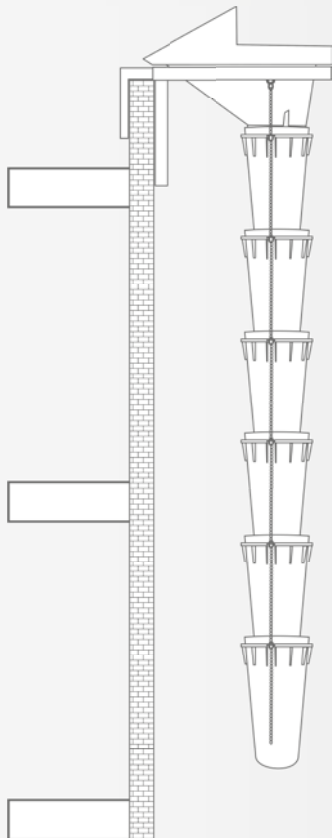

**Lescha**

SHOZ STAVEBNÍ SUTI



Č.p.	specifikace	
35603	shoz základní průměr 50/ 40 cm, délka 108 cm PE (HDPE)	1
35604	násepka shozu stavební suti PE (HDPE)	1
35605	nosný rám pro násepku shozu stavební suti	1

# HORIZONT®



## HORIZONT®

### LAŤ STAHOVACÍ - BEZ LIBEL

ALU

č.p.	specifikace	
15310	100 cm	10
15315	150 cm	10
15318	180 cm	10
15320	200 cm	10
15325	250 cm	10
15330	300 cm	10
15335	350 cm	10
15340	400 cm	10



## HORIZONT®

### LAŤ STAHOVACÍ - 1 LIBELA

ALU

č.p.	specifikace	
15415	150 cm	10
15418	180 cm	10
15420	200 cm	10
15425	250 cm	10
15430	300 cm	10



## HORIZONT®

### LAŤ STAHOVACÍ - 2 LIBELY

ALU

č.p.	specifikace	
15510	100 cm	10
15515	150 cm	10
15518	180 cm	10
15520	200 cm	10
15525	250 cm	10
15530	300 cm	10
15535	350 cm	10
15540	400 cm	5



## HORIZONT®

### LAŤ STAHOVACÍ - 2 MADLA, BEZ LIBEL

ALU

č.p.	specifikace	
15615	150 cm	10
15620	200 cm	10
15625	250 cm	10
15630	300 cm	10



## HORIZONT®

### LAŤ STAHOVACÍ - 2 MADLA, 2 LIBELY

ALU

č.p.	specifikace	
15710	100 cm	10
15715	150 cm	10
15720	200 cm	10
15725	250 cm	10
15730	300 cm	10
15735	350 cm	10
15740	400 cm	5





**HORIZONT**  
LAŤ STAHOVACÍ - TRAPÉZOVÝ PROFIL

PROFIL TRAPÉZOVÝ

- trapézový profil slouží k jemnějším úpravám povrchu
- vhodné pro štukatéry a fasádníky
- vhodný pro tenkovrstvé omítky

ALU	Č.p.	specifikace	
	15810	100 cm	10
	15812	120 cm	10
	15815	150 cm	10
	15818	180 cm	10
	15820	200 cm	10
	15825	250 cm	10
	15830	300 cm	10



**HORIZONT**  
LAŤ STAHOVACÍ - H PROFIL

PROFIL "h"

- "h" profil slouží k jemnějším úpravám povrchu
- vhodné pro štukatéry a fasádníky
- vhodná ke štukování stropních omítek

ALU	Č.p.	specifikace	
	15850	100 cm	10
	15853	150 cm	10
	15855	180 cm	10
	15860	200 cm	10
	15870	250 cm	10
	15880	300 cm	10

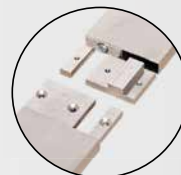

NEW

**HORIZONT**  
SPOJKA  
PRO STAHOVACÍ  
LAŤE HORIZONT

ALU	Č.p.	Specifikace		
	15301		1	



**HORIZONT**  
STAHOVACÍ LAŤ  
NASTAVITELNÁ

ALU	Č.p.	Specifikace		
	15893	65 - 100 cm	1	
	15894	95 - 150 cm	1	
	15895	145 - 235 cm	1	



**HORIZONT**  
ÚHELNÍK STAVEBNÍ

ALU	Č.p.	specifikace	
	14485	800 x 1200 mm	1
	14486	1000 x 1500 mm	1



**FESTA**

## OHÝBAČKA TYČÍ, TŘMENŮ, DRÁTŮ



Č.p.	Specifikace	
26730	Ø 6 - 14 mm	1
26731	Ø 5 - 8 mm	1



NEW

**FESTA**

## DRŽÁK CIHEL A DLAŽBY



Č.p.	Specifikace	
60130	27 - 45 cm	10

NEW

**FESTA**

## KLEŠTĚ NA DLAŽBU



Č.p.	Specifikace	
60132		1

NEW

**FESTA**VOZÍK  
NA  
OBRUBNÍKY

· max 150 kg



Č.p.	Specifikace	
60157		1



## OHÝBAČKA TYČÍ

Č.p.	Specifikace	
26735	max Ø 13 mm 56 cm	1

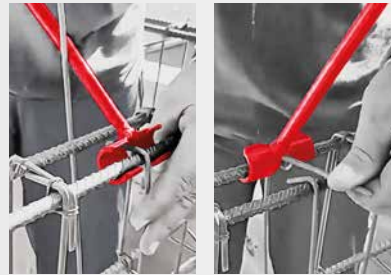

NEW

## OHÝBAČKA TŘMENŮ

· Ø 4-8 mm

Č.p.	Specifikace	
26736		1

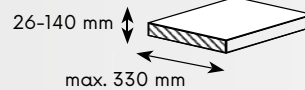

NEW

**FESTA**

## LAMAČKA DLAŽBY

· max 45 kg

Č.p.	Specifikace	
60125		1



NEW

**FESTA**VOZÍK  
NA  
DLAŽBU

· max 100 kg



Č.p.	Specifikace	
60155		1



30 - 50 cm

## DRŽÁK DLAŽBY STAVITELNÝ

Č.p.	specifikace	
36310	max. 20kg	5



## NOSIČ OBRUBNÍKŮ

specifikace	60116
rozměr čelistí:	750-1000 mm
max. zatížení:	120 kg

Č.p.	specifikace	
60116	PRO 041	1



## PALICE PRO SROVNÁNÍ ŘAD

specifikace	60121	60123
výška	200 mm	200 mm
šířka	70 kg	70 kg
délka	870 mm	450 mm
hmotnost	2,5 kg	2,2 kg

Č.p.	specifikace	
60121	870 mm	1
60123	450 mm	1



## NOSIČ OBRUBNÍKŮ

specifikace	60115
rozměr čelistí:	80-370 mm
max. zatížení:	50 kg

Č.p.	specifikace	
60115	PRO 040	1



## NOSIČ OBRUBNÍKŮ

specifikace	60117	60118
rozměr čelistí:	500-1000 mm	0-500 mm
max. zatížení:	150 kg	150 kg

Č.p.	specifikace	
60117	PRO 042	1
60118	PRO 043	1



## PODLOŽKA VYROVNÁVACÍ POD DLAŽBU

Č.p.	specifikace	
37166	D10 základní	25



## KLADKA ZEDNICKÁ Z 500

Č.p.	specifikace	
26780	0,5 t A s hákem	1
26781	0,5 t B s okem	1
26782	0,5 t C s hákem a chráničem	1
26783	0,5 t D s okem a chráničem	1

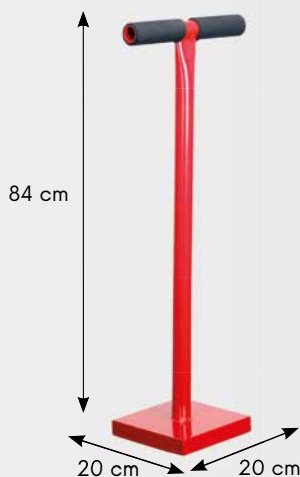

## RUČNÍ PĚCHOVADLO

Č.p.	specifikace	
26740	12 kg	1



## RUDL

Č.p.	specifikace	nosnost	
48719	kolo 260 mm bantam	250 kg	1



## PROFESIONÁLNÍ ŘEZAČKY OBKLADŮ

- řezačky dlažby pro nejnáročnější profesionální použití
- pojezd je řešen 9 zapouzdřenými kuličkovými ložisky skf
- 4 jsou stavitelné a vymezují vůli pojezdu
- odpružené stoly
- lze kompletovat i pro práci levou rukou
- zajištěny veškeré náhradní díly a servis
- řezná kolečka z chrom wolframové oceli

**SUPER PRO**



### ŘEZAČKA DLAŽBY SUPER PRO "EVO"

· 36195 náhr. řezné kolečko - Ø 22 mm



Č.p. specifikace  
36191 1250 mm



1



**SUPER PRO**



### ŘEZAČKA DLAŽBY SUPER PRO

· 36195 náhr. řezné kolečko - Ø 22 mm



Č.p.	specifikace	
36145	SUPER PRO 450 mm	1
36160	SUPER PRO 600 mm	1
36175	SUPER PRO 750 mm	1
36190	SUPER PRO 900 mm	1



1

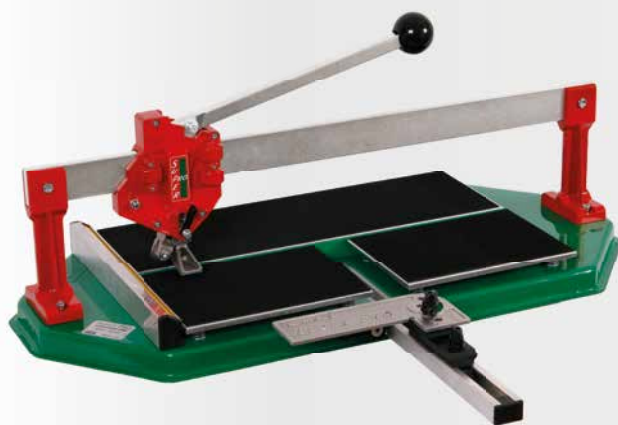

· ilustrační foto

### PRODEJNÍ STOJAN SUPER PRO



Č.p.	specifikace	
36200	prodejní stojan	1
36199	prodejní stojan osazený 36160, 36175, 36190	1



**FESTA**

**ŘEZAČKA DLAŽBY „X“**

· 36138 náhr. řezné kolečko - Ø 22 mm



Č.p.	specifikace	
36085	600 mm	1
36087	900 mm	1
36086	1300 mm	1



**FESTA**

**ŘEZAČKA DLAŽBY**

· 36139 náhr. řezné kolečko - Ø 22 mm



Č.p.	Specifikace	
36102	1050 mm	1
36103	1300 mm	1
36105	1550 mm	1



**FESTA**

**ŘEZAČKA DLAŽBY**

· 36195 náhr. řezné kolečko - Ø 22 mm



Č.p.	specifikace	
36080	600 mm	1
36081	750 mm	1
36082	900 mm	1
36076	750 mm složená	1
36077	900 mm složená	1



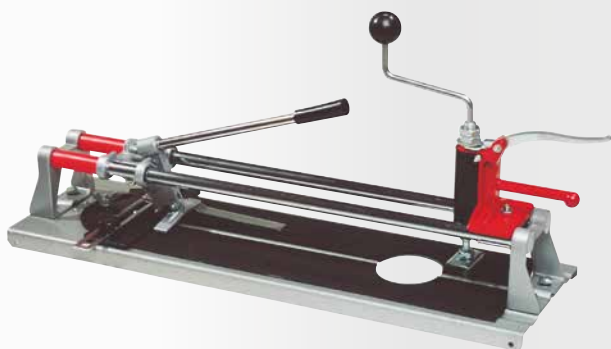

### ŘEZAČKA DLAŽBY S VYKRUŽOVÁKEM

· 36128 náhr. řezné kolečko - Ø 16 mm



Č.p.	specifikace	
36014	480 mm	4

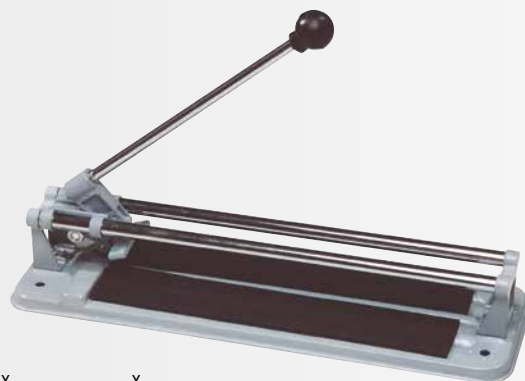

### ŘEZAČKA DLAŽBY

· 36126 náhr. řezné kolečko - Ø 15 mm



Č.p.	specifikace	
36024	300 mm	10
36034	400 mm	10
36035	600 mm	4



### ŘEZAČKA DLAŽBY

· 36136 náhr. řezné kolečko - Ø 22 mm



Č.p.	specifikace	
36036	480 mm	1



### ŘEZAČKA DLAŽBY RUČNÍ

· 36136 náhr. řezné kolečko - Ø 22,2 mm



Č.p.	specifikace	
36046	22 mm	1

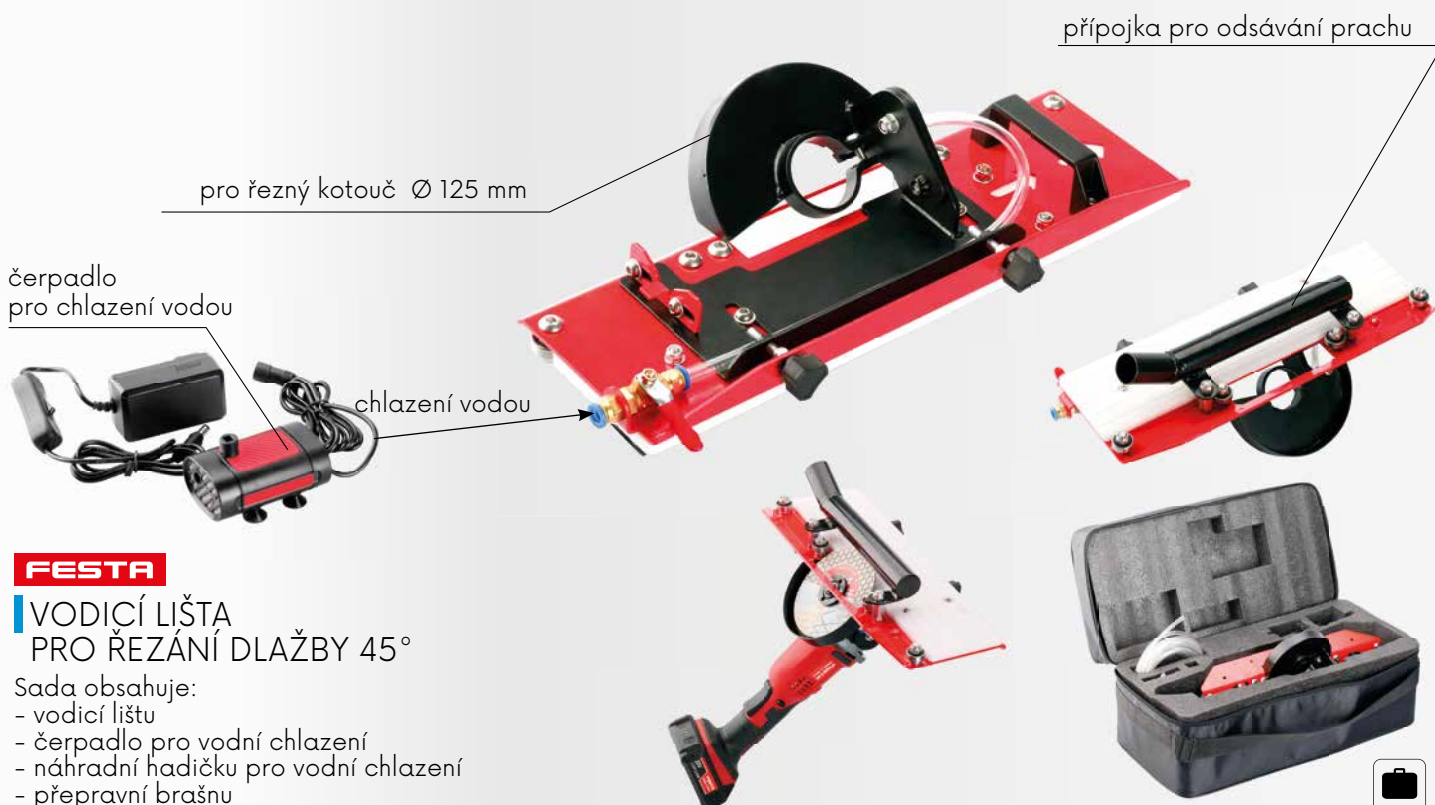

**FESTA**

### VODICÍ LIŠTA PRO ŘEZÁNÍ DLAŽBY 45°

Sada obsahuje:

- vodicí lištu
- čerpadlo pro vodní chlazení
- náhradní hadičku pro vodní chlazení
- přepravní brašnu

Č.p.	Specifikace	
24680		1



NÁHRADNÍ KOLEČKO DO ŘEZAČEK DLAŽBY



Broj	specifikacija	
36126	a= Ø 15 mm, b= Ø 6 mm, c= 1,5 mm	1
36128	a= Ø 16 mm, b= Ø 6 mm, c= 3 mm	1
36130	a= Ø 20 mm, b= Ø 6 mm, c= 5 mm	1
36136	a= Ø 22 mm, b= Ø 6 mm, c= 2 mm	1
36138	a= Ø 22 mm, b= Ø 6 mm, c= 5 mm	1
36139	a= Ø 22 mm, b= Ø 6 mm, c= 6 mm	1
36195	a= Ø 22 mm, b= Ø 6 mm, c= 4,8 mm	1



PILKA PŘÍMOČARÁ NA OBKLADY A KERAMIKU

Č.p.	specifikace	
24055	karbid - BOSCH, MAKITA	1



KLEŠTĚ NA OBKLADY



Č.p.	specifikace	
36056		10



**FESTA**

KLEŠTĚ NA OBKLADY



Č.p.	specifikace	
36057	200 mm	6



KLEŠTĚ ŠTÍPACÍ NA KERAMIKU

Č.p.	specifikace	
36059		1



KLEŠTĚ NA OBKLADY "PAPOUŠEK"

Č.p.	specifikace	
36058	200 mm	6

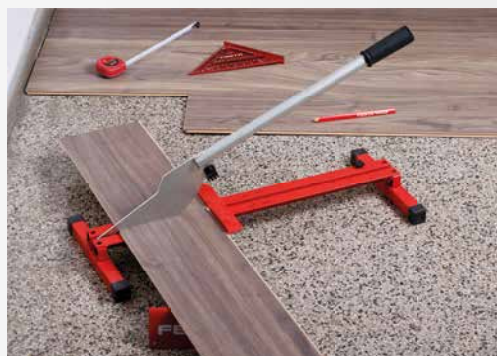

**FESTA**

ŘEZAČKA VINYLU A LAMINÁTU



Č.p.	specifikace	
36140	210 mm	4



NEW



FESTA

## STĚRKA NA SILIKON 5V1

Č.p.	specifikace
37050	



1

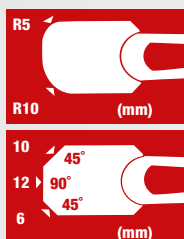

FESTA

## APLIKÁTOR SILIKONU

Č.p.	specifikace
16056	145 mm



50

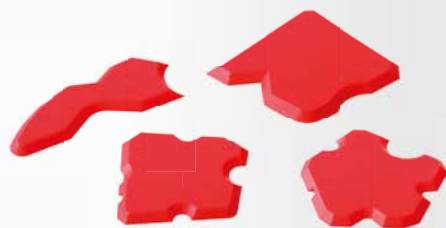

## STĚRKY NA SILIKON - SADA

4x

Č.p.	specifikace
37052	



1



## STĚRKY NA SILIKON - SADA

4x

Č.p.	specifikace
37053	



48



## STĚRKA

Č.p.	specifikace
37054	



1



## STĚRKA

na spárování oken

Č.p.	specifikace
37055	na spárování oken



1

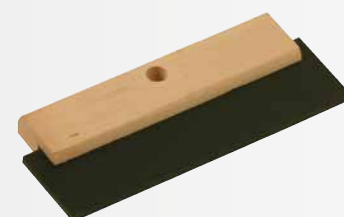

## STĚRKA DŘEVĚNÁ S GUMOU

Č.p.	specifikace
37011	180 mm
37021	280 mm

Č.p.	specifikace
37011	180 mm
37021	280 mm



12

12



37028



37029

## HOUBA VYMÝVACÍ 160 X 110 X 60 MM

Č.p.	specifikace
37028	hydro houba
37029	mořská houba



1

1



37025



37026

## HOUBA VYMÝVACÍ 200 X 100 X 100 MM

Č.p.	specifikace
37025	jemný molitan
37026	mořská houba



1

1



## VANIČKA VYMÝVACÍ

Č.p.	specifikace
37117	sada
90070	nádoba 25 l



1

1

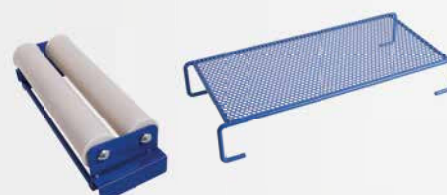

## VANIČKA VYMÝVACÍ - PŘÍSLUŠENSTVÍ

Č.p.	specifikace
90072	mřížka
90071	válečky kovové



1

1



4 mm

ČISTIČ SPÁR



Č.p.	specifikace	
37012		1



37006

37007

ČISTIČ SPÁR



Č.p.	specifikace	
37006	30 mm	20
37007	50 mm	20
37008	náhradní ostří 30 mm	50
37009	náhradní ostří 50 mm	50



SADA NA APLIKACI A ODSTRANĚNÍ SILIKONU

3x



Č.p.	specifikace	
16042		12

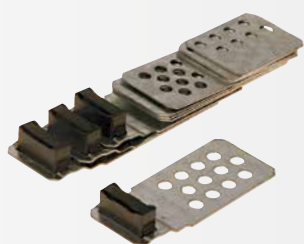

MAGNETY POD OBKLADY



4x



Č.p.	specifikace	
38920		1



MAGNETY STAVITELNÉ POD OBKLADY



4x



Č.p.	specifikace	
38923		24



ROŽKY STAVEBNÍ - SADA

Č.p.	specifikace	
38919		50



PISTOLE SPÁROVACÍ

objem 1,5 l



Č.p.	specifikace	
38026	5x špička	25



PYTEL SPÁROVACÍ



Č.p.	specifikace	
38042	3x špička	6

NEW

- Ø 10 mm
- Ø 14 mm
- Ø 20 mm
- Ø 10 x 35 mm

3 l



Ø 10 mm

FESTA APLIKÁTOR NA SPÁROVACÍ HMOTY

4x tryska

Č.p.	specifikace	
38045		1



### MONTÁŽNÍ SADA NA PLOVOUCÍ PODLAHY

24x

Č.p.	specifikace	ks	
52130		1	1



### MONTÁŽNÍ KLÍNKY PLAST

50x

Č.p.	specifikace	ks	
37210	95 x 45 x 15 - 0 mm	50	1
37211	70 x 30 x 8 - 0 mm	50	1



### POLŠTÁŘEK MONTÁŽNÍ, ROZPÍNACÍ

· rozměr 15•17 cm  
· max. výška 5 cm

Č.p.	specifikace	ks	
37220		1	1

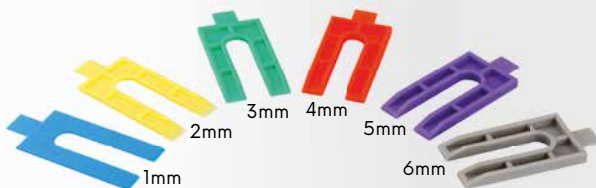

### VYMEZOVACÍ PODLOŽKY

30x

Č.p.	specifikace	ks	
37212	1 - 6 mm, 5 ks každé velikosti	1	1

FESTA

### MONTÁŽNÍ KLÍNKY DŘEVĚNÉ



Č.p.	specifikace	ks	
37204	55 x 20 x 0 - 6 mm	20	1
37203	65 x 18 x 0 - 12 mm	20	1
37202	80 x 25 x 3 - 10 mm	20	1
37201	100 x 25 x 1 - 16 mm	14	1
37200	150 x 25 x 1 - 25 mm	8	1



FESTA

### KLÍNKY OBKLADAČSKÉ



Č.p.	specifikace	ks	
37155	0 - 8 mm	30	100
37156	0 - 4 mm	100	100
37157	2,5 - 8 mm	30	100



FESTA

### MONTÁŽNÍ KLÍNKY DŘEVĚNÉ

250x

Č.p.	specifikace	ks	
37205	55 x 8 x 0 - 10 mm	250	1



NEW

NIVELYS  
LEVELING SYSTEM FESTA

### ZAKLÁDACÍ PROFIL

ALU

Č.p.	Specifikace	
37105	50 cm	1
37106	100 cm	1
37107	150 cm	1



NEW



140 - 520 mm

NIVELYS  
LEVELING SYSTEM FESTA

### NASTAVITELNÉ PODPĚRY PRO ZAKLÁDACÍ PROFIL

· max. 50 kg

2x

Č.p.	Specifikace	
37102		1





# NIVELYS

LEVELING SYSTEMS

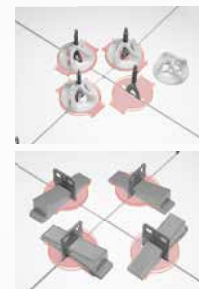

NIVELYS  
LEVELING SYSTEMS FESTA

## DISTANČNÍ KLIP SE ZÁVITEM

50x

Č.p.	specifikace	ks
37131	1 mm	40
37132	2 mm	40

NIVELYS  
LEVELING SYSTEMS FESTA

## KLOBOUČEK NIVELAČNÍ SE ZÁVITEM

· opakovaně použitelné

50x

Č.p.	specifikace	ks
37130		15

NIVELYS  
LEVELING SYSTEMS FESTA

## PODLOŽKA, OCHRANNÁ POD NIVELAČNÍ SYSTÉM

100x

Č.p.	Specifikace	ks
37192		1

NIVELYS  
LEVELING SYSTEMS FESTA

## DISTANČNÍ SPONY

· nivelační klínky 37175, 37176

50x

Č.p.	specifikace	ks	ks
37170	1 mm	50	60
37171	2 mm	50	60
37172	3 mm	50	60

NIVELYS  
LEVELING SYSTEMS FESTA

## DISTANČNÍ SPONY

100x

Č.p.	specifikace	ks	ks	Č.p.	specifikace	ks	ks
37185	1 mm	100	1	37187	3 mm	100	1
37190	1,5 mm	100	1	37188	4 mm	100	1
37186	2 mm	100	1	37189	5 mm	100	1

NIVELYS  
LEVELING SYSTEMS FESTA

## SPONY DISTANČNÍ

100x

Č.p.	Specifikace	ks
37162	1,5 mm	1

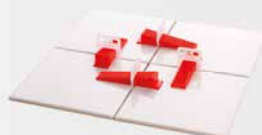
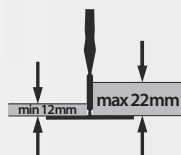

NIVELYS  
LEVELING SYSTEMS FESTA

## NIVELAČNÍ KLÍNKY

Č.p.	ks	ks
37175	50	40
37176	400	3



NIVELYS  
LEVELING SYSTEMS FESTA

**NIVELYS**  
LEVELING SYSTEMS **FESTA**
**DISTANČNÍ SPONY**
**600x**

Č.p.	specifikace	ks	krabice	
37125	1 mm	600	38 x 28 x 19 cm	1
37126	1,5 mm	600	38 x 28 x 19 cm	1
37127	2 mm	600	38 x 28 x 19 cm	1

**NIVELYS**  
LEVELING SYSTEMS **FESTA**
**NIVELAČNÍ SADA**

Č.p.	specifikace		
37173	spony 1 mm,	400 ks + klínky 200 ks	1
37174	spony 1,5 mm,	400 ks + klínky 200 ks	1

**NIVELYS**  
LEVELING SYSTEMS **FESTA**
**KLEŠTĚ NIVELAČNÍ**

Č.p.		
37177		1

**NIVELYS**  
LEVELING SYSTEMS **FESTA**
**KLEŠTĚ NIVELAČNÍ**

Č.p.		
37178		1

**NIVELAČNÍ KLIP SADA**
**50x**

Č.p.	specifikace	
37199	1,5 mm	40



40

**NIVELYS**  
LEVELING SYSTEMS **FESTA**
**KŘÍŽKY DISTANČNÍ**

opakovaně použitelné

**100x**

Č.p.	specifikace	ks	
37195	1,0 mm	100	12
37196	1,5 mm	100	12
37197	2 mm	100	12
37198	3 mm	100	12

**FESTA**
**KŘÍŽKY OBKLADAČSKÉ**

Č.p.	specifikace	ks	
37148	1,0 mm	200	100
37149	1,5 mm	200	100
37150	2 mm	200	100
37151	2,5 mm	200	100
37152	3 mm	150	100
37153	4 mm	100	100
37154	5 mm	75	100
37158	10 mm	30	100

**FESTA**
**KŘÍŽKY NA OBKLADY A DLAŽBU S ÚCHYTEM**
**100x**

Č.p.	specifikace	
37285	1,5 mm	100
37286	2 mm	100
37287	2,5 mm	100
37288	3 mm	100
37289	4 mm	100

**NEW**

horizontální poloha 110 kg  
 vertikální poloha 80 kg  
 Ø 220 mm  
 USB-C

**FESTA**  
 POWER X TOOLS

**PŘÍSAVKA AKU**

Ø 220 mm 80kg 110kg ROUGH SURFACE USB-C Li-ion 3.6V 2Ah

Č.p. Specifikace  
 36326

1

**FESTA**

**PŘÍSAVKA NA DLAŽBU S INDIKÁTOREM TLAKU**

Ø 200 mm 140kg 100kg ROUGH SURFACE

Č.p. Specifikace  
 36325

1

**FESTA**

**SKLENÁŘSKÝ DRŽÁK**

poloha	max. nosnost
horizontální poloha	120 kg
vertikální poloha	150 kg

**ALU**

Č.p. specifikace  
 36318 trojitý 10

**FESTA**

**SKLENÁŘSKÝ DRŽÁK**

poloha	max. nosnost
horizontální poloha	80 kg
vertikální poloha	100 kg

**ALU**

Č.p. specifikace  
 36313 dvojitý 20

**FESTA**

**SKLENÁŘSKÝ DRŽÁK**

poloha	max. nosnost
horizontální poloha	50 kg
vertikální poloha	50 kg

**ALU**

Č.p. specifikace  
 36314 jednoduchý 20

**SKLENÁŘSKÝ DRŽÁK**

Č.p. specifikace  
 36305 jednoduchý 60

**SKLENÁŘSKÝ DRŽÁK**

Č.p. specifikace  
 36306 dvojitý 20

**SKLENÁŘSKÝ DRŽÁK**

poloha	max. nosnost
horizontální poloha	80 kg
vertikální poloha	100 kg

Č.p. specifikace  
 36319 trojitý 10

**FESTA**SADA NAVÍJEČ 30 M  
+ PUDR 120 G· 6x rychlejší mechanismus navíjení  
· funkce olovniceČ.p.  
37070

6

**FESTA**SADA NAVÍJEČ 30 M  
+ PUDR 150 G

· 5x rychlejší mechanismus navíjení

Č.p.  
37065

6

SADA NAVÍJEČ ABS 30 M  
+ PUDR 180 GČ.p.  
37069

10

NAVÍJEČ PLASTOVÝ  
30 MČ.p.  
37066

25

NAVÍJEČ KOVOVÝ  
30 M

ALU

Č.p.  
37068

25

NAVÍJEČ ABS  
30 MČ.p.  
37067

25

**FESTA**

## PUDR 180 G

Č.p.	specifikace	
37096	modrý	10
37094	světle modrý	10
37097	červený	10
37095	světle červený	10
37098	černý	10

**FESTA**

## PROVÁZEK ČERVENÝ



Č.p.	specifikace	
38895	50 m	24
38896	100 m	24

**FESTA**

## PROVÁZEK ŽLUTÝ



Č.p.	specifikace	
38899	50 m	24
38900	100 m	24

**FESTA**PROVÁZEK ZEDNICKÝ  
POLYETYLEN 50 M

Č.p.	specifikace	
38907	červený 1,0 mm	100
38908	červený 1,7 mm	100
38909	červený 2,0 mm	100



**FESTA**

PROVÁZEK ZEDNICKÝ  
POLYETYLEN 50 M

Č.p.	specifikace	
38904	žlutý 1,0 mm	100
38905	žlutý 1,7 mm	100
38906	žlutý 2,0 mm	100



**FESTA**

PROVÁZEK ZEDNICKÝ  
POLYETYLEN 50 M

Č.p.	specifikace	
38910	oranžový 1,0 mm	100
38911	oranžový 1,7 mm	100
38912	oranžový 2,0 mm	100



**FESTA**

PROVÁZEK ZEDNICKÝ  
POLYETYLEN 50 M

Č.p.	specifikace	
38901	bílý 1,0 mm	100
38902	bílý 1,7 mm	100
38903	bílý 2,0 mm	100



ŠŤŮRA VOSKOVANÁ



Č.p.	délka	Ø	
50920	50 m	1 mm	80



**FESTA**

OLOVNICE S PROVÁZKEM  
15 M

Č.p.	specifikace	
38916	150 g	10
38917	300 g	6
38918	500 g	5

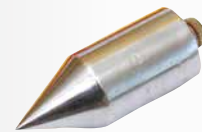

**FESTA**

OLOVNICE

Č.p.	specifikace	
38913	150 g	10
38914	300 g	10
38915	500 g	10

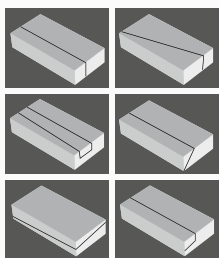

**FESTA****ŘEZAČKA POLYSTYRENU STRUNOVÁ**

- napětí/frekvence: 230 V/50 Hz
  - příkon: 200 W
  - délka řezu: 137 cm
  - výška řezu: 30 cm
  - krytí: IP44
  - úhel řezu: 0° - 90°
- vybavení: stojan, nožní spínač, držák na lešení, 2x Ni-Cr řezací drát, čistící mosazný kartáč, nářadí a spojovací materiál, plastový box s kolečky



Č.p. Specifikace

35348

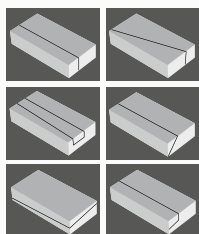

1

**FESTA****ŘEZAČKA POLYSTYRENU STRUNOVÁ**

- napětí/frekvence: 230 V / 50 Hz
- příkon: 200 W
- délka řezu: 137 cm
- výška řezu: 30 cm
- krytí: IP44
- úhel řezu: 0° - 90°



· vybavení: Ni-Cr řezací drát, čistící mosazný kartáč, inbus

Č.p. specifikace

35345

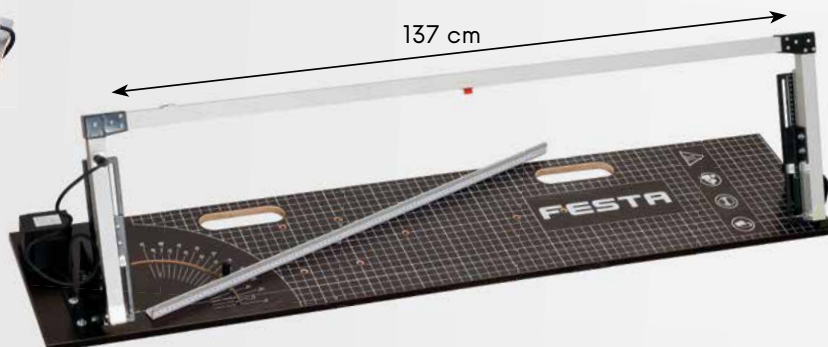

1

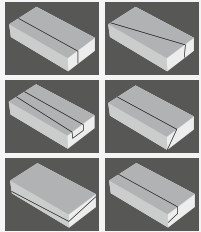
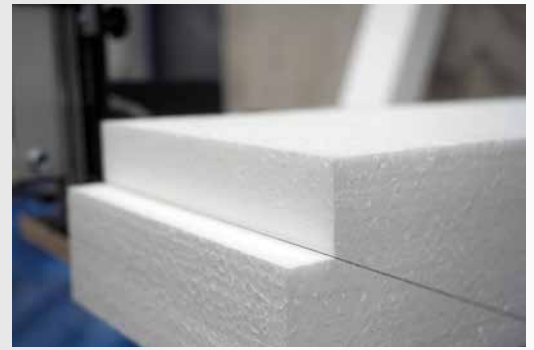

**FESTA**

ŘEZAČKA POLYSTYRENU STRUNOVÁ

- napětí/frekvence: 230 V / 50 Hz
- příkon: 160 W
- délka řezu: 117 cm
- výška řezu: 52 cm
- krytí: IP44
- úhel řezu: 0° - 90°



· vybavení: Ni-Cr řezací drát, čistící mosazný kartáč, inbus

Č.p. specifikace

35344

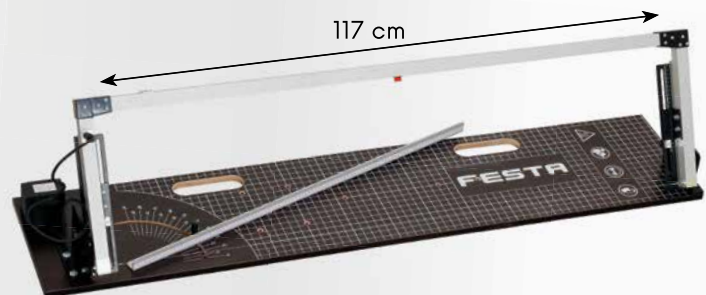
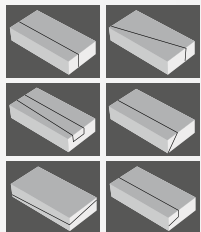

**FESTA**

ŘEZAČKA POLYSTYRENU STRUNOVÁ

- napětí/frekvence: 230 V / 50 Hz
- příkon: 160 W
- délka řezu: 117 cm
- výška řezu: 30 cm
- krytí: IP44
- úhel řezu: 0° - 90°



· vybavení: Ni-Cr řezací drát, čistící mosazný kartáč, inbus

Č.p. specifikace

35330



**FESTA**

### NOŽNÍ SPÍNAČ PRO ŘEZAČKU POLYSTYRENU

pro 35330, 35345, 35348

Č.p. Specifikace

35334



1

**FESTA**

### STOJAN PRO ŘEZAČKU POLYSTYRENU

pro 35330, 35345, 35348

Č.p. Specifikace

35336



1

**FESTA**

### NÁHRADNÍ PRUŽINA PRO ŘEZAČKU POLYSTYRENU

pro 35330, 35345, 35348

Č.p. Specifikace

35332



1

**FESTA**

### ZDROJ NÁHRADNÍ K ŘEZAČCE POLYSTYRENU

pro 35330, 35345, 35348



napětí/frekvence: 230 V / 50Hz

output: 36 V / 5 A

výkon: 200 W

Č.p.

35347



1

**FESTA**

### DRŽÁK NA LEŠENÍ PRO ŘEZAČKU POLYSTYRENU

pro 35330, 35345, 35348

Č.p. Specifikace

35333



1

**FESTA**

### NÁHRADNÍ STRUNA Cr-Ni PRO ŘEZAČKY POLYSTYRENU

Č.p. specifikace

35331 pro řezačku 117 cm

35346 pro řezačku 137 cm



1





**FESTA**

**ŘEZAČKA POLYSTYRENU AKUMULÁTOROVÁ**

- baterie 36 V, 1,5Ah Li-ion
- výkon 180 W
- teplota max 350 C°
- délka čepele 20 cm
- vybavení: 2 ks baterie, nabíječka, čepel, čistící mosazný kartáč, inbus



Č.p.	specifikace	
35323	elektrická řezačka polystyrenu	1
35328	náhr. nůž do řezačky polystyrenu 14 cm	1
35329	náhr. nůž do řezačky polystyrenu 25 cm	1

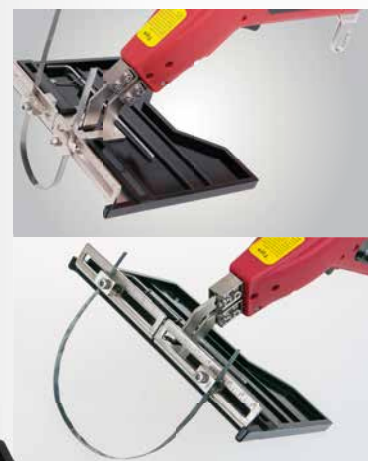

**FESTA**

**ŘEZAČKA POLYSTYRENU ELEKTRICKÁ**

- napětí / frekvence 230 V/50 Hz
- příkon 250 W
- teplota 50-600 C°
- délka čepele 25 cm
- délka přívodního kabelu 3 m



• vybavení: čistící mosazný kartáč, inbus, nůž 25 cm, kufr

Č.p.	specifikace	
35326	elektrická řezačka polystyrenu	1
35328	náhr. nůž do řezačky polystyrenu 14 cm	1
35329	náhr. nůž do řezačky polystyrenu 25 cm	1



**VODÍČÍ LIŠTA PRO ŘEZAČKU POLYSTYRENU**

• pro 35323, 35326

Č.p.	specifikace	
35327	vodíčí lišta	1
35335	náhradní nůž - 30 cm	1



**FESTA**

**ŘEZAČKA POLYSTYRENU ELEKTRICKÁ**



• regulace teploty

Č.p.	specifikace	
35325	220 W	1



**FESTA**FRÉZA  
DO POLYSTYRENU A VATY

ALU



Č.p.	specifikace	
24752	Ø 65 mm	1
24753	Ø 70 mm	1



## FRÉZA DO POLYSTYRENU

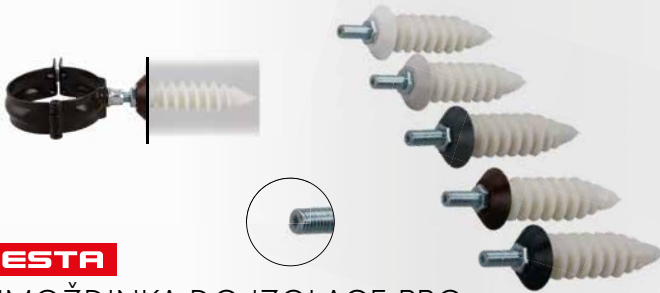

Č.p.	specifikace	
24727	Ø 65 mm	1
24729	Ø 68 mm	1
24728	Ø 70 mm	1

**FESTA**HMOŽDINKA DO IZOLACE PRO  
ŠROUBOVACÍ OBJÍMKY SVODU

2x



Č.p.	specifikace	
39240	bílá M10	1
39241	šedá M10	1
39242	antracit M10	1
39243	hnědá M10	1
39244	černá M10	1



## VÁLEČEK NIVELAČNÍ

MADE IN EU

Č.p.	průměr	výška hrotů	délka	
38950	Ø 69 mm	12 mm	25 cm	10
38951	Ø 69 mm	12 mm	40 cm	8
38952	Ø 122 mm	34 mm	25 mm	10
38953	Ø 122 mm	34 mm	40 cm	8
38954	Ø 122 mm	34 mm	60 mm	4

HMOŽDINKA  
FASÁDNÍ

100x

MADE IN EU



Č.p.	specifikace		Č.p.	specifikace	
39210	Ø 10 x 100 mm	1	39218	Ø 10 x 180 mm	1
39212	Ø 10 x 120 mm	1	39217	Ø 10 x 200 mm	1
39214	Ø 10 x 140 mm	1	39219	Ø 10 x 220 mm	1
39216	Ø 10 x 160 mm	1			



## PODLOŽKA ZATEPLOVACÍ

pro šrouby Ø 6 a 8 mm

50x

Č.p.	specifikace	
39208	Ø 68 mm	1

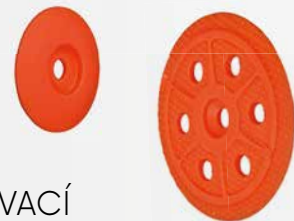

## PODLOŽKA ZATEPLOVACÍ

MOQ

Č.p.	specifikace	
39206	Ø 40 mm	200
39207	Ø 60 mm	100

PODEŠVE  
S HROTY PÁR

MADE IN EU

Č.p.	specifikace	
38970	hroty 25 mm	1
38971	hroty 30 mm	1



PODLOŽKA RABICOVÁ



Č.p.	specifikace	
42420	Ø 30 mm	1



PLETIVO RABICOVÉ



Č.p.	specifikace	
42312	1 m   50 bm 16 x 16 mm	1

DŘEVĚNÝ OMÍTNÍK



Č.p.	délka	tloušťka	šířka	
37120	200 mm	1,7 mm	20 mm	10
37119	250 mm	1,7 mm	20 mm	10



SÍTO NA ŠTUK



Č.p.	šířka	výška	oko síta	
37216	50 mm	50 mm	2 mm	1
37217	50 mm	50 mm	3 mm	1
37218	50 mm	50 mm	4 mm	1

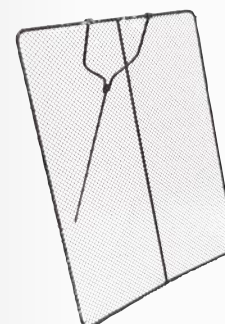

SÍTO PROHAZOVACÍ

Č.p.	šířka	výška	oko síta	
37236	0,8 m	1 m	10 mm	1
37237	0,8 m	1 m	12 mm	1
37238	0,8 m	1 m	16 mm	1
37239	0,8 m	1 m	20 mm	1



VLÁKNO VÝZTUŽNÉ DO BETONU 0,9KG

- +/- 150 g/ 50 kg cementu
- 600 - 900 g/m<sup>2</sup> betonu nebo malty



Č.p.	váha	
42115	0,9 kg	9



SÍŤ NA LEŠENÍ

Č.p.	specifikace	
42120	2,5 x 20 m, 80 g/m <sup>2</sup> zelená	5



OMÍTAČKA



Č.p.	
37114	1



OMÍTAČKA



Č.p.	specifikace	
37115		1



### SKOBA ZEDNICKÁ POZINK

Č.p.	specifikace	MOQ
37231	14 cm volně	10



### SKOBA ZEDNICKÁ KOVANÁ

Č.p.	specifikace	MOQ
37232	14,5 cm	5



### SKOBA ZEDNICKÁ SADA

Č.p.	specifikace	MOQ
37230	16 cm	6

### KRAMLE POZINKOVANÁ

Č.p.	specifikace	MOQ
37233	320 x 10 mm	100
37234	320 x 12 mm	100

### KRAMLE

Č.p.	specifikace	MOQ
37235	250 x 12 mm	1

### ROH HLINÍKOVÝ

Č.p.	specifikace	MOQ
39245	AL 30 m x 5 cm	1

### ROH PLASTOVÝ

Č.p.	specifikace	MOQ
39238	3 m	25

### ŠPACHTLE PRO SÁDROKARTONÁŘE

Č.p.	specifikace	MOQ
34308	50 mm	20
34307	80 mm	12
34306	100 mm	10
34305	150 mm	12

### ZVEDÁK SÁDRO- KARTONOVÝCH DESEK

- zdvih 153 - 344 cm
- maximální zatížení 54 kg

Č.p.	specifikace	MOQ
26775		1

### SADA PRO SÁDROKARTONÁŘE

Č.p.	specifikace	MOQ
34300	sada 9 ks	10
34303	vanička	60

### FESTA NOSIČ DESEK

Č.p.	specifikace	MOQ
36312		12

### FESTA NOSIČ DESEK

Č.p.	specifikace	MOQ
36308	36 x 16,5 x 7,5 cm	10



RAŠPLE  
NA SÁDROKARTON



Č.p.	specifikace	
22120	250 x 40 mm	10



RAŠPLE  
NA SÁDROKARTON



Č.p.	specifikace	
22121	250 x 40 mm	10
22122	140 x 40 mm	6



RAŠPLE  
NA SÁDROKARTON



Č.p.	specifikace	
22126	155 x 40 mm	1



RAŠPLE  
NA SÁDROKARTON



Č.p.	specifikace	
22125	Ø 250 x 40 mm	6



RAŠPLE  
NA SÁDROKARTON



Č.p.	specifikace	
22124	Ø 250 x 16 mm	10



RAŠPLE  
NA SÁDROKARTON



Č.p.	specifikace	
22123	60 x 40 mm	6

**FESTA**

PILKA  
NA SÁDROKARTON



Č.p.	specifikace	
24159	150 mm	12



HOBLÍK  
NA SÁDROKARTON



Č.p.	specifikace	
34315		10
34316	náhradní břit	1



PILKA VRTACÍ  
NA SÁDROKARTON



Č.p.	specifikace	
24190	300 mm	10

RAŠPLE  
NÁHRADNÍ

Č.p.	specifikace	
22130	250 x 40 mm	20
22129	155 x 40 mm	20
22132	140 x 40 mm	20
22133	60 x 40 mm	20
22134	Ø 16 x 250 mm	20

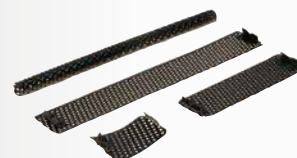

**FESTA****PB HOŘÁK - SADA**

Ø 17, 22, 40 mm



Č.p.	specifikace	
69918	2 kW, 3 m hadice	10

**FESTA****PB HOŘÁK - SADA**

Ø 25, 35, 50 mm



Č.p.	specifikace	
69919	19,5 kW, 1,5 m hadice	10

**FESTA****PB HOŘÁK**

Č.p.	specifikace	
69900	Ø 35 mm, délka 300 mm, bez hadice	10
69901	Ø 35 mm, délka 300 mm + 3 m hadice	5

**FESTA****PÁJECÍ SOUPRAVA 3 KW**

Č.p.	specifikace	
69914	300 mm + 2 m hadice	5

**FESTA****PB HOŘÁK**

Č.p.	specifikace	
69902	Ø 55 mm, délka 550 mm, bez hadice	10

**FESTA****PB HOŘÁK**

Č.p.	specifikace	
69903	Ø 55 mm, délka 550 mm + 3 m hadice	10

**FESTA****PB HOŘÁK**

Č.p.	specifikace	
69905	Ø 55 mm, délka 900 mm, bez hadice	10

**FESTA****PB HOŘÁK**

Č.p.	specifikace	
69906	Ø 55 mm, délka 900 mm + 3 m hadice	5



## FESTA

### PB HOŘÁK - SADA



Ø 55 mm



Č.p. 69904 specifikace 60 kW, 850 mm, 5 m hadice

8

## FESTA

### PB HOŘÁK - SADA S REDUKČNÍM VENTILEM



· redukční ventil pro připojení 10 a 33 kg bomby



Č.p. 69917 specifikace Ø 60 mm, délka 900 mm + 3 m hadice 3 m

1

## FESTA

### HADICE PRO PB HOŘÁK

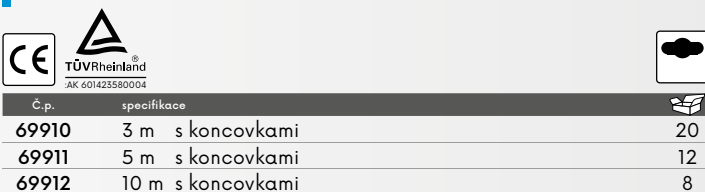

Č.p.	specifikace	
69910	3 m s koncovkami	20
69911	5 m s koncovkami	12
69912	10 m s koncovkami	8

20  
12  
8



### REDUKČNÍ VENTIL PROPAN BUTAN

vstupní tlak	25 bar
výstupní tlak	0,5 - 4,0 bar
jmenovitý průtok	16 kg   h
připojení - vstup	W 21,8 x 1   14" LH
připojení - výstup	G3   8" LH



Č.p. 69907 specifikace

1



### REDUKČNÍ VENTIL PROPAN BUTAN

vstupní tlak	4,0 bar
jmenovitý průtok	16 kg   h
připojení - vstup	W 21,8 x 1   14" LH
připojení - výstup	G3   8" LH



Č.p. 69920 specifikace

25



### REDUKČNÍ VENTIL PROPAN BUTAN



Č.p. 69923 specifikace W 21,8; G 3/8; 4 bar



### REGULÁTOR TLAKU



Č.p.	specifikace	
69908	30 mBar, trn	1
69909	30 mBar, závit G 1/4L	1



### JEDNOCESTNÝ UZAVÍRACÍ VENTIL

· výstup G 3/8L, pro 2 kg PB láhev



Č.p. 69928 specifikace

1

**FESTA****HOŘÁK PLYNOVÝ NA KARTUŠI SE ZÁVITEM**

- max. teplota: 1200 °C
- výkon: 1,7 kW
- průměr hořáku: Ø 20 mm



Č.p.	specifikace
69930	piezo

20

**FESTA****HOŘÁK PLYNOVÝ NA PROPICHOVACÍ KARTUŠI**

- max. teplota: 1200 °C
- výkon: 1,7 kW
- průměr hořáku: Ø 20 mm



Č.p.	specifikace
69931	piezo

12

**MISKA NA SÁDRU**

Č.p.	specifikace
37121	kónická



1

**MISKA NA SÁDRU**

Č.p.	specifikace
37122	nízká



1

**MISKA NA SÁDRU**

Č.p.	specifikace
33275	nízká gumová



20

**VĚDRO POZINKOVANÉ**

Č.p.	specifikace
39000	5 l
39001	10 l
39002	12 l
39003	15 l



40

30

20

20

**VĚDRO ZEDNICKÉ**

Č.p.	specifikace
39005	5 l
39010	10 l
39012	12 l
39014	15 l s nálevkou
39020	20 l
39021	20 l s nálevkou



1

1

1

1

1

1

**NÁDOBA PLAST - PRUŽNÁ**

Č.p.	specifikace
39192	30 l
39193	45 l



20

20

**ZEDNICKÁ NÁDOBA KRUHOVÁ**

Č.p.	specifikace
39045	45 l Ø 54 x 27 cm
39065	60 l Ø 60 x 35 cm
39090	90 l Ø 66 x 35 cm



1

1

1

**ZEDNICKÁ NÁDOBA OBDELNÍKOVÁ**

Č.p.	specifikace
39145	40 l 71 x 40 x 21 cm
39165	65 l 71 x 40 x 30 cm
39190	85 l 77 x 48 x 30 cm



1

1

1



# FESTA

• nárazuvzdorná rukojeť  
nylon + sklovlákno



• otočná hlava o 360°

• 3 polohy přepínání  
zpětného odskoku



• přepínání dávkování  
9:1 / 18:1



## FESTA

PISTOLE VYTLAČOVACÍ  
S PŘEPÍNAČEM ZPĚTNÉHO ODSKOKU  
A DÁVKOVÁNÍ

Č.p. specifikace

38027



1

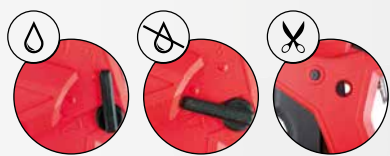

NEW



## FESTA

PISTOLE VYTLAČOVACÍ  
S PŘEPÍNAČEM  
ZPĚTNÉHO  
ODSKOKU

Č.p. Specifikace

38032 nylonová



24

## FESTA

PISTOLE VYTLAČOVACÍ  
S PŘEPÍNAČEM  
ZPĚTNÉHO  
ODSKOKU



Č.p. specifikace

38028



1

## FESTA

PISTOLE  
VYTLAČOVACÍ  
ZESILENÁ



Č.p. specifikace

38013



12

## FESTA

PISTOLE  
VYTLAČOVACÍ



Č.p. specifikace

38001



24

## FESTA

PISTOLE  
VYTLAČOVACÍ



Č.p. specifikace

38012



6

## FESTA

PISTOLE  
VYTLAČOVACÍ



Č.p. specifikace

38024



1

PISTOLE  
VYTLAČOVACÍ  
SE ZPĚTNÝM  
ODSKOKEM



Č.p.	specifikace	
38010	6ti hran	24

PISTOLE  
VYTLAČOVACÍ



Č.p.	specifikace	
38025		24

**FESTA**

PISTOLE  
VYTLAČOVACÍ  
NA CHEMICKÉ  
KOTVY 380 ML



Č.p.	specifikace	
38020		12

PISTOLE  
VYTLAČOVACÍ  
KROKOVÁ



Č.p.	specifikace	
38006		12

PISTOLE  
VYTLAČOVACÍ



Č.p.	specifikace	
38002	6ti hran	24

PISTOLE  
VYTLAČOVACÍ  
PLASTOVÁ



Č.p.	specifikace	
38003	6ti hran	24

PISTOLE  
VYTLAČOVACÍ



Č.p.	specifikace	
38007		24

PISTOLE  
VYTLAČOVACÍ  
PLASTOVÁ,  
POLOUZAVŘENÁ



Č.p.	specifikace	
38008		24

PISTOLE  
VYTLAČOVACÍ  
OZUBENÁ



Č.p.	specifikace	
38009		24

PISTOLE  
VYTLAČOVACÍ



Č.p.	specifikace	
38000		24

**FESTA**

PISTOLE  
VYTLAČOVACÍ



ALU

Č.p.	specifikace	20
38005	310 ml	20
38014	špička 3 ks	100

**FESTA**

PISTOLE  
VYTLAČOVACÍ



ALU

Č.p.	specifikace	12
38004	600 ml	12
38014	špička 3 ks	100

**FESTA**

PISTOLE NA  
PU PĚNY  
S TEFLONOVÝM  
POVRCHEM



TEFLON

Č.p.	specifikace	20
38018		20

**FESTA**

PISTOLE NA  
PU PĚNY  
S TEFLONOVÝM  
POVRCHEM



TEFLON

Č.p.	specifikace	20
38017		20

**FESTA**

PISTOLE NA  
PU PĚNY



TEFLON

Č.p.	specifikace	20
38016		20

**FESTA**

PISTOLE NA  
PU PĚNY



TEFLON

Č.p.	specifikace	20
38015		20

PISTOLE NA  
PU PĚNY



Č.p.	specifikace	20
38031		20

**FESTA**

PISTOLE NA  
PU PĚNY  
ABS



Č.p.	specifikace	20
38022	ABS	20

PISTOLE NA  
PU PĚNY



Č.p.	specifikace	24
38021		24

TRYSKA NÁHRADNÍ  
NA PISTOLE

pro pistole 38015, 38016, 38017, 38018



TEFLON	Č.p.	specifikace	5
	38030		5



## ŠTĚTEC PLOCHÝ NATUR

Č.p.	šířka	tloušťka	délka	
52212	20 mm	15 mm	40 mm	12
52213	30 mm	15 mm	45 mm	12
52214	40 mm	15 mm	45 mm	12
52215	50 mm	15 mm	50 mm	12
52216	60 mm	15 mm	60 mm	12
52217	70 mm	15 mm	65 mm	12
52218	80 mm	15 mm	65 mm	12
52220	100 mm	15 mm	70 mm	12



## ŠTĚTEC PLOCHÝ

Č.p.	šířka	tloušťka	délka	
52202	20 mm	12,5 mm	38 mm	12
52203	30 mm	13 mm	38 mm	12
52204	40 mm	14 mm	44 mm	12
52205	50 mm	16 mm	44 mm	12
52206	60 mm	17 mm	52 mm	12
52208	80 mm	17 mm	52 mm	12
52207	100 mm	18 mm	52 mm	12



## ŠTĚTEC ZÁROHOVÝ

Č.p.	šířka	tloušťka	délka	
52283	25 mm	10 mm	44 mm	12
52284	38 mm	10 mm	44 mm	12
52285	50 mm	10 mm	44 mm	12
52286	62 mm	10 mm	50 mm	12
52288	76 mm	10 mm	50 mm	12

SADA ŠTĚTCŮ  
PLASTOVÁ RUKOJEŽ

3x

Č.p.	specifikace	
52070	20, 30, 50 mm	50

MALÍŘSKÁ ŠTĚTKA  
PROFI

MADE IN EU

Č.p.	specifikace	
52075	Ø 90 mm	10

MALÍŘSKÁ ŠTĚTKA  
PROFI

MADE IN EU

Č.p.	šířka	délka	
52076	170 mm	80 mm	10

SADA ŠTĚTCŮ  
PLASTOVÁ RUKOJEŽ

5x

Č.p.	specifikace	
52071	15 mm, 25 mm, 40 mm, 60 mm, 80 mm	50



## MALÍŘSKÁ ŠTĚTKA

Č.p.	specifikace	délka	
52077	Ø 105 mm	70 mm	12



## MALÍŘSKÁ ŠTĚTKA





Č.p.	šířka	délka	
52078	170 mm	70 mm	12

## TABULKA POUŽITÍ MALÍŘSKÝCH VÁLEČKŮ





## BARVY A LAKY

MATERIÁL	VÝŠKA VLASU l mm	DISPERZNÍ	ANTIKOROZNÍ	PRYSKYŘIC.	OLEJOVÉ	VODOU ŘED.	POLYESTEROVÉ	POJMOVÉ	LAZURY	LATEXOVÉ	EPOXYDOVÉ	2-KOMPONENTNÍ	HUSTÉ	AKRYLOVÉ
PES	20	•						•		•			•	
PES	20	•	•			•		•		•				•
PAC	18	•						•		•				
PAC	12, 13	•								•				
PAD	18, 21	•								•				
PAD	13	•	•							•				
BERÁNEK	23	•								•				
NYLON	13		•	•	•	•	•			•	•	•		
VELOUR	4		•	•			•				•	•	•	
MICROFIBRE	10					•			•	•				
MOLITAN				•		•								•





VÁLEČEK POLYAKRYL

<b>PAC</b>					
<b>MADE IN EU</b>					
Č.p.					
52331	100 mm	Ø 6 mm	Ø 17 mm	12 mm	50
52334	250 mm	Ø 8 mm	Ø 48 mm	12 mm	10





VÁLEČEK POLYAKRYL

<b>PAC</b>					
<b>MADE IN EU</b>					
Č.p.					
52391	polster 5 250 mm	Ø 8 mm	Ø 54 mm	18 mm	10





VÁLEČEK POLYAKRYL

<b>PAC</b>					
<b>MADE IN EU</b>					
Č.p.					
52328	polster 5 250 mm	Ø 8 mm	Ø 54 mm	18 mm	10
52456	polster 7 250 mm	Ø 8 mm	Ø 67 mm	18 mm	10





VÁLEČEK POLYAMID

<b>PAD</b>					
<b>MADE IN EU</b>					
Č.p.					
52428	polster 7 250 mm	Ø 8 mm	Ø 67 mm	18 mm	10





VÁLEČEK LAZUROVACÍ - NYLON

<b>PAD</b>					
<b>MADE IN EU</b>					
Č.p.					
52421	100 mm	Ø 6 mm	Ø 17 mm	13 mm	50
52424	250 mm	Ø 8 mm	Ø 48 mm	13 mm	10

VÁLEČEK POLYESTER

<b>PES</b>					
<b>MADE IN EU</b>					
Č.p.					
52305	180 mm	Ø 6 mm	Ø 42 mm	20 mm	10
52306	250 mm	Ø 6 mm	Ø 42 mm	20 mm	10

VÁLEČEK LAKOVACÍ MOLITAN

<b>MADE IN EU</b>					
Č.p.					
52471	rovný	100 mm	Ø 6 mm	Ø 35 mm	50



## PENETRAČNÍ SOUPRAVA

PAC

MADE IN EU



Č.p.	specifikace	objem
52600	polster 4 180 mm Ø 8 mm Ø 53 mm 18 mm	1

## MALÍŘSKÁ SOUPRAVA - VESTAN

PES

MADE IN EU

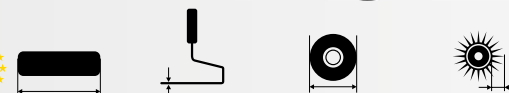

Č.p.	specifikace	objem
52610	180 mm Ø 6 mm Ø 42 mm 20 mm	25
52605	250 mm Ø 6 mm Ø 42 mm 20 mm	20

## LAKOVACÍ SADA

- 1x váleček PAD 13mm/ 10 cm
- 1x váleček PAC 12mm/ 10 cm
- 1x váleček PES 11mm/ 10 cm
- držák
- miska

MADE IN EU



Č.p.	objem
52602	10

## ROHOVÝ VÁLEČEK POLYAKRYL

PAC

MADE IN EU

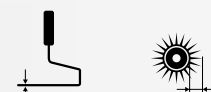

Č.p.	specifikace	objem
52601	včetně držáku Ø 6 mm 18 mm	1

## MISKA

MADE IN EU



Č.p.	specifikace	objem
52662	150 x 270 mm 100 mm	1
52666	260 x 290 mm 180 mm	1
52671	330 x 340 mm 250 mm	1

## KBELÍK NA BARVU

MADE IN EU



Č.p.	objem	objem
52694	8 l	25
52695	12 l	20

## MŘÍŽKA

MADE IN EU



Č.p.	šířka	výška	objem
52652	230 mm	250 mm	100
52656	270 mm	290 mm	100



## DRŽÁK

MADE IN EU



## DRŽÁK



Č.p.	specifikace	objem
52640	5 cm   Ø 6 mm	100
52645	8,5 cm   Ø 6 mm x 27 mm	100

MADE IN EU

Č.p.	specifikace	objem
52630	18 cm   Ø 6 mm	100
52635	25 cm   Ø 6 mm	100
52620	18 cm   Ø 8 mm	50
52625	25 cm   Ø 8 mm	50

## ŠKRABKA NA BARVY A LAKY

Č.p.	objem
37005	12



**FESTA**

**TELESKOPICKÁ TYČ**

závit pro 31610, 34203

Č.p.	specifikace	
52011	88 - 140 cm	1



**TELESKOPICKÁ TYČ**

**ALU**

Č.p.	délka		
52010	120 cm	ALU	50
52012	240 cm	ALU	25



**TELESKOPICKÁ TYČ**

Č.p.	délka		
52020	300 cm	ocel	10



**TELESKOPICKÁ TYČ**

Č.p.	délka		
52030	240 cm	fiberglass	6



**PÁSKA KRYCÍ SAMOLEPÍCÍ S FÓLIÍ**

Č.p.	šířka	délka	
37243	55 cm	30 m	60
37244	110 cm	30 m	30
37245	140 cm	30 m	30
37246	180 cm	15 m	30
37290	210 cm	20 m	30
37247	240 cm	15 m	30
37291	270 cm	16 m	30



**OCHRANNÁ KOMBINÉZA S KAPUCÍ**

Č.p.	specifikace	
50585	velikost M	1
50586	velikost L	1
50587	velikost XL	1
50588	velikost XXL	1



**FOLIJE DO DVEŘÍ SE ZIPEM**

Č.p.	specifikace	
37248	1,2 x 2,2 m páska 100 µm 45 mm x 25 m	25



**UNIVERZÁLNÍ KRYCÍ FÓLIE**

Č.p.	objem	tloušťka materiálu	
37250	4 x 5 m	0,007 mm	100
37251	4 x 12,5 m	0,007 mm	50
37252	2 x 50 m	0,007 role	20



**UNIVERZÁLNÍ KRYCÍ FÓLIE**

Č.p.	specifikace	tloušťka materiálu	
37253	4 x 5 m	0,03 mm	100



**LEPENKA VLNITÁ**



Č.p.	šířka	délka	
54008	1 m	10 m	1

# FESTA



PE PLACHTA  
PROFI

· modro-stříbrná

140 g/m<sup>2</sup>



Č.p.	specifikace	
25206	2 x 3 m	25
25212	3 x 4 m	10
25215	3 x 5 m	8
25220	4 x 5 m	8
25224	4 x 6 m	8
25230	5 x 6 m	8

Č.p.	specifikace	
25240	5 x 8 m	4
25248	6 x 8 m	3
25260	6 x 10 m	3
25296	8 x 12 m	2
25350	10 x 15 m	1



ZAKRÝVACÍ  
PLACHTA  
EKONOMIK

· modrá



Č.p.	specifikace	
25369	2 x 2 m	50
25370	2 x 3 m	20
25371	3 x 4 m	10
25372	3 x 5 m	10
25373	4 x 5 m	10

Č.p.	specifikace	
25374	4 x 6 m	5
25376	5 x 8 m	5
25378	6 x 10 m	2
25379	8 x 12 m	2
25380	10 x 15 m	2

ZAKRÝVACÍ  
PLACHTA

· modro-stříbrná

70 g/m<sup>2</sup>



Č.p.	specifikace	
25155	2 x 2 m	50
25006	2 x 3 m	50
25009	3 x 3 m	35
25012	3 x 4 m	20
25015	3 x 5 m	10
25016	4 x 4 m	10
25020	4 x 5 m	10
25024	4 x 6 m	10

Č.p.	specifikace	
25025	5 x 5 m	10
25030	5 x 6 m	10
25040	5 x 8 m	5
25048	6 x 8 m	5
25060	6 x 10 m	5
25096	8 x 12 m	2
25150	10 x 15 m	2
25153	15 x 20 m	1

ZAKRÝVACÍ  
PLACHTA

· zelená

70 g/m<sup>2</sup>



Č.p.	specifikace	
25179	2 x 2 m	50
25180	2 x 3 m	50
25195	2 x 8 m	20
25181	3 x 4 m	20
25182	3 x 5 m	10
25183	4 x 5 m	10

Č.p.	specifikace	
25184	4 x 6 m	10
25186	5 x 8 m	5
25188	6 x 10 m	5
25189	8 x 12 m	2
25190	10 x 15 m	2

PE PLACHTA  
PROFI

· zeleno-zelená

200 g/m<sup>2</sup>



Č.p.	specifikace	
25160	2 x 3 m	15
25171	2 x 8 m	1
25162	3 x 5 m	5
25163	4 x 5 m	4

Č.p.	specifikace	
25164	4 x 6 m	3
25167	6 x 8 m	2
25169	8 x 12 m	1
25170	10 x 15 m	1

PE PLACHTA  
KULATÁ

· modro-stříbrná

120 g/m<sup>2</sup>



Č.p.	specifikace	
25003	Ø 3,6 m	15
25004	Ø 4,5 m	5
25005	Ø 5,5 m	4
25002	Ø 6,5 m	3



NAPÍNÁK  
PLACHET

4x

Č.p.	specifikace	
25400	20 cm	1



APLIKÁTOR OK DO PLACHET

Č.p.	specifikace	
25410	aplikátor ok + 25 ok	1



OKA DO  
PE PLACHET

10x

Č.p.	specifikace	
25001		1



## ŽEBŘÍK TELESKOPICKÝ SKLÁDACÍ

· max. nosnost 150 kg



Č.p.	specifikace		
48415	1,9 / 3,8 m	6/12 příček	1

## ŽEBŘÍK TELESKOPICKÝ

· max. nosnost 150 kg



Č.p.	specifikace		
48410	3,2 m	11 příček	1
48411	3,8 m	13 příček	1

## PLOŠINA PRACOVNÍ SKLÁDACÍ

· max. nosnost 150 kg

ALU

Č.p.	specifikace	
48420		1



NEW

2.75m	H L	H L	1.73m	0.93m	0.99m
	1.60m 1.14m	1.69m 1.32m			

## PRACOVNÍ PLOŠINA

KG  
13,6

· max 150 kg

Č.p.	Specifikace	
37660		1





**KOZA LEŠENÁŘSKÁ**



Č.p.	specifikace	
37545	140 cm, výška 98 - 165 cm	1
37546	120 cm, výška 98 - 165 cm	1



**STOJKA BEDNÍČÍ**

· 48449 klec na bednici stojky



Č.p.	specifikace	
48452	160 - 290 cm	1
48453	180 - 320 cm	1
48454	200 - 360 cm	1
48455	250 - 440 cm	1
48456	260 - 380 cm	1
48457	220 - 400 cm	1

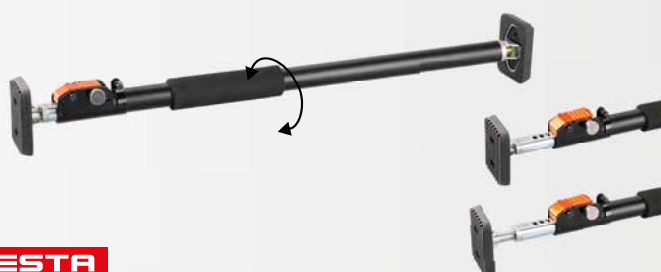

**FESTA**

**TYČ ROZPÍNACÍ, PODPĚRNÁ**

· max. nosnost 40 kg

Č.p.	specifikace		
52060	66 - 115 cm	1	
52065	160 - 290 cm	1	



**TYČ ROZPÍNACÍ, PODPĚRNÁ**

Č.p.	specifikace		
52050	50 - 115 cm	1	
52055	115 - 290 cm	1	

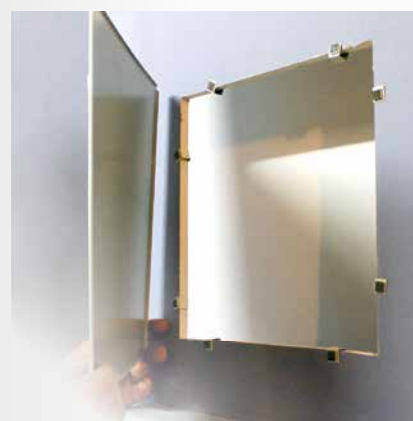

**KRYT OTVORU MAGNETICKÝ**

	Č.p.	specifikace	
	82100	10 - 21 cm	1
	82101	20 - 31 cm	1
	82102	30 - 41 cm	1
	82103	40 - 51 cm	1
	82104	50 - 58 cm	1



**DVÍŘKA KOMÍNOVÁ PLECHOVÁ**



Č.p.	specifikace	
65062		1



**DVÍŘKA KOMÍNOVÁ KOMAX**



Č.p.	specifikace	
65063	šedá	1
65064	bílá	1



**DVÍŘKA KOMÍNOVÁ ZINKOVANÁ**



Č.p.	specifikace	
65065		1

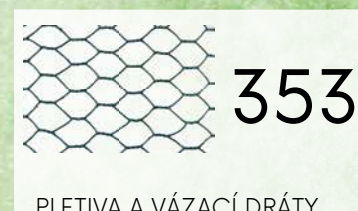
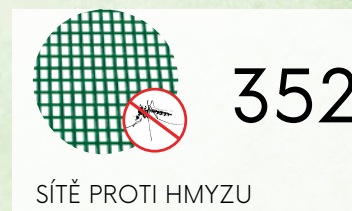
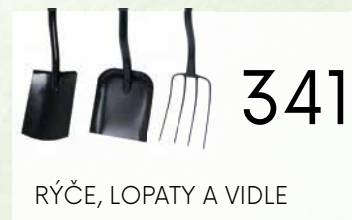
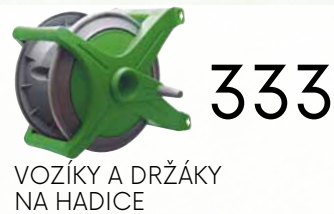



ZAHRADNÍ NÁŘADÍ  
A PLETIVA

308 - 359



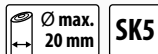

WINLAND®

ZAHRADNICKÉ  
NŮŽKY

Č.p.	specifikace	
45020	205 mm	10
44980	náhradní pružina	1



WINLAND®

ZAHRADNICKÉ  
NŮŽKY

Č.p.	specifikace	
45023	205 mm	10
44980	náhradní pružina	1

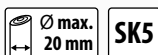

WINLAND®

ZAHRADNICKÉ  
NŮŽKY

Č.p.	specifikace	
45063	215 mm	10
44981	náhradní pružina	1

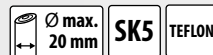

WINLAND®

ZAHRADNICKÉ  
NŮŽKY

Č.p.	specifikace	
44972	215 mm	10
44981	náhradní pružina	1



WINLAND®

ZAHRADNICKÉ  
NŮŽKY

Č.p.	specifikace	
45099	190 mm	10
44983	náhradní pružina	1



WINLAND®

ZAHRADNICKÉ  
NŮŽKY

Č.p.	specifikace	
45098	220 mm	10
44983	náhradní pružina	1



WINLAND®



WINLAND®

ZAHRADNICKÉ  
NŮŽKY

Č.p.	specifikace	
45095	200 mm	10
44982	náhradní pružina	1

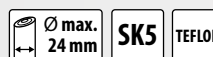

WINLAND®

ZAHRADNICKÉ  
NŮŽKY

Č.p.	specifikace	
45096	220 mm	6
44982	náhradní pružina	1



· otočná rukojeť



## ZAHRADNICKÉ NŮŽKY



Č.p.	specifikace	
45089	160 mm	10



## ZAHRADNICKÉ NŮŽKY



Č.p.	specifikace	
45097	210 mm	10
44981	náhradní pružina	1



## ZAHRADNICKÉ NŮŽKY



Č.p.	specifikace	
45088	160 mm	10

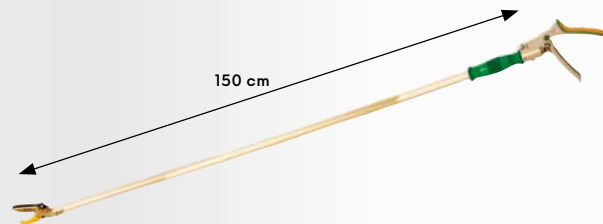

Č.p.	specifikace	
45017	ZAHRADNICKÉ NŮŽKY PRODLOUŽENÉ	10



## NÁHRADNÍ PRUŽINA



Č.p.	pro nůžky	
44981	45021, 45025, 45063, 45097	1
44980	45020, 45023	1
44983	45098, 45099	1
44982	45027, 45095, 45096	1
44984	45110, 45014, 45026	1
44985	45018	1



## NÁHRADNÍ BŘIT

pro nůžky 45095, 45027



Č.p.	specifikace	
45094		20



## NŮŽKY NA VĚTVE



Č.p.	specifikace	
44991	76 cm	12



## NŮŽKY NA VĚTVE TELESKOPICKÉ



Č.p.	specifikace	
44992	70 - 103 cm	10



## NŮŽKY

TEFLON



Č.p.	specifikace	
44996	61 cm, vlnité ostří	12



## NŮŽKY

TEFLON



Č.p.	specifikace	
44997	61 cm, rovné ostří	12

NŮŽKY NA TRÁVU  
OTOČNÉ 360°

Č.p.	specifikace	
44998		6

BROUSEK NA NŮŽKY  
A NOŽE 6 V 1

Č.p.	specifikace	
45068		10

BROUSEK NA NŮŽKY  
A NOŽE

Č.p.	specifikace	
45048		20



## FESTA

NŮŽKY  
ZAHRADNICKÉ

nylonová rukojeť



Č.p.	specifikace	
45021	210 mm	6

NŮŽKY  
ZAHRADNICKÉ

Č.p.	specifikace	
45019	210 mm	10



FESTA

## NŮŽKY

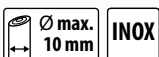

Č.p.	specifikace	
45010	190 mm	12
44984	náhradní pružina	1



## NŮŽKY

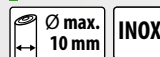

Č.p.	specifikace	
45014	190 mm	12
44984	náhradní pružina	1



## NŮŽKY

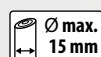

Č.p.	specifikace	
45026	150 mm	12
44985	náhradní pružina	1

NŮŽKY  
ZAHRADNICKÉ

Č.p.	specifikace	
45018	210 mm kované	10



## NŮŽKY ZAHRADNICKÉ

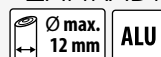

Č.p. specifikace  
45025 200 mm



12

## NŮŽKY ZAHRADNICKÉ

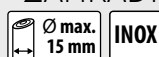

Č.p. specifikace  
44970 210 mm



10

## NŮŽKY ZAHRADNICKÉ



Č.p. specifikace  
45027 200 mm



10

## NŮŽKY ZAHRADNICKÉ



Č.p. specifikace  
45029 200 mm



24

## NŮŽKY ZAHRADNICKÉ

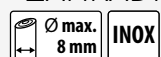

Č.p. specifikace  
44971 160 mm



10

## NŮŽKY ZAHRADNICKÉ

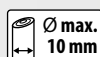

Č.p. specifikace  
45016 180 mm



12

## NŮŽKY ZAHRADNICKÉ

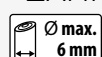

Č.p. specifikace  
45015 190 mm, rovné



12

## POUZDRO NA ZAHRADNICKÉ NŮŽKY

Č.p. specifikace  
37317



1

## NŮŽKY NA TRÁVU

Č.p. specifikace  
45011 300 mm



1

## NŮŽKY NA TRÁVU OTOČNÉ

Č.p. specifikace  
45012 370 mm, otočné 180°



1



## NŮŽKY NA VĚTVĚ



Č.p. specifikace  
44999 540 mm, oblé

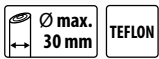

12

**FESTA**NŮŽKY  
NA VĚTVE

Č.p.	specifikace	
45000	750 mm, oblé	6

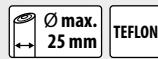
**FESTA**NŮŽKY  
NA VĚTVE

Č.p.	specifikace	
45001	710 mm, oblé	6

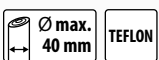
**FESTA**NŮŽKY  
NA VĚTVE

Č.p.	specifikace	
45002	750 mm, ráčnové	12

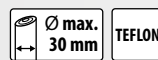
NŮŽKY  
NA VĚTVE  
TELESKOPICKÉ

Č.p.	specifikace	
45003	660-900 mm, teleskopické	6

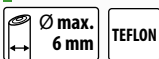
**FESTA**NŮŽKY  
NA VĚTVE

Č.p.	specifikace	
45005	580   230 mm, vlnité ostří	6

**FESTA**

NŮŽKY

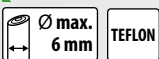

Č.p.	specifikace	
45006	580   230 mm, rovné ostří	6

**FESTA**NŮŽKY  
TELESKOPICKÉ

Č.p.	specifikace	
45007	670-870   230 mm, vlnité ostří	6



NŮŽKY



Č.p.	specifikace	
44995	440   160 mm	12



NŮŽKY

Č.p.	specifikace	
45009	500   190 mm, vlnité ostří	6



NŮŽKY

Č.p.	specifikace	
45008	500   190 mm, rovné ostří	6



SRP

Č.p.	specifikace	
45490	450 mm	1



## FESTA MAČETA



TEFLON

Č.p.	specifikace	
45069	440 mm	6

## FESTA MAČETA

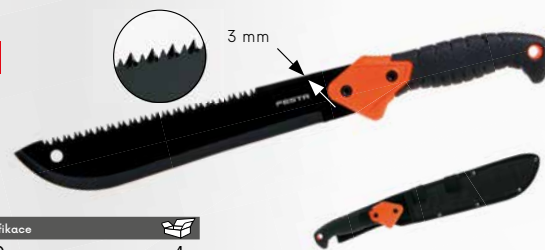

TEFLON

Č.p.	specifikace	
44950	490 mm	4

## MAČETA NEREZ

INOX

Č.p.	specifikace	
45083	430 mm	12
45084	600 mm	6



## MAČETA

· rukojeť vyrobená z jasanového dřeva

Č.p.	specifikace	
45081	510 mm	36
45082	710 mm	36



## FESTA PILA ZAVÍRACÍ

· 3 x broušené a kalené zuby

Č.p.	specifikace	
45061	150 mm s krytem rukojeti	12



## FESTA PILA ZAVÍRACÍ

· 3 x broušené a kalené zuby

Č.p.	specifikace	
45060	180 mm	6



## FESTA PILA S POUZDREM

· 3 x broušené a kalené zuby

Č.p.	specifikace	
45062	260 mm s pouzdrém	24



## FESTA PILA PROŘEZÁVACÍ

· 3 x broušené a kalené zuby

Č.p.	specifikace	
24152	350 mm 7 tpi	12



## FESTA PILA TELESKOPICKÁ PROŘEZÁVACÍ

· 3 x broušené a kalené zuby

Č.p.	specifikace	
45033	230 - 490 mm	1



## HOUSENICE S PILOU

Č.p.	specifikace	
45030	pilka 30 cm	6
45031	pilka 30 cm	6



## HOUSENICE

Č.p.	specifikace	
45032	kovová housenice bez pilky	6



**FESTA**
**FESTA**
**SEKERA**
**DIN 5131**
**DIN 7294**

- jasanová násada
- kruhový klín



Č.p.	specifikace		Č.p.	specifikace	
19380	600 g	1	19384	1400 g	1
19381	800 g	1	19385	1600 g	1
19382	1000 g	1	19387	2000 g	1
19383	1250 g	1			

**FESTA**
**SEKERA  
TESAŘSKÁ**

- jasanová násada



Č.p.	specifikace	
19340	700 g	22

**FESTA**
**KALAČ**

- jasanová násada
- kruhový klín

DIN	Č.p.	specifikace	
5129	19389	3000 g	1
	19388	4000 g	1

**FESTA**
**SEKERA ŠTÍPACÍ**

- jasanová násada
- kruhový klín

DIN		Č.p.	specifikace	
7294		19391	2000 g	1

**FESTA**
**SEKERA FIBERGLASS**

- násada fiberglass

Č.p.	specifikace	
19326	600 g	6
19328	800 g	24
19330	1000 g	12
19332	1250 g	8
19333	1500 g	6
19335	1600 g	6
19337	2000 g	6

**FESTA**
**SEKERA ŠTÍPACÍ  
FIBERGLASS**

- násada fiberglass

Č.p.	specifikace	
19392	1000 g	6

**FESTA**
**SEKERA CAMP  
FIBERGLASS**

- násada fiberglass

Č.p.	specifikace	
19301	500 g	6

**FESTA**
**SEKERA ŠTÍPACÍ FIBERGLASS**

- násada fiberglass

Č.p.	specifikace	
19390	2000 g	6





**FESTA**

## KALAČ FIBERGLASS

násada fiberglass

Č.p.	specifikace	
19370	3000 g	4
19371	4000 g	4



## NÁSADA NA SEKERU JASANOVÁ



Č.p.	specifikace	pro sekeru	
61340	36 cm	19380	10
61341	40 cm	19381, 19340	10
61342	50 cm	19382	10
61343	70 cm	19383, 19384	10
61344	80 cm	19385, 19391	10
61345	90 cm	19387	10
61346	90 cm	19388, 19389	10

## SEKERA

Č.p.	specifikace	
19306	600 g	24
19308	800 g	24
19310	1000 g	24
19312	1250 g	12
19314	1500 g	12



## KLÍN ŠTÍPACÍ TORZNÍ

Č.p.	specifikace	
19397	2000 g 55 x 210 x 45 mm	10
19465	2500 g 65 x 230 x 45 mm	10



## KLÍN ROZEVÍRACÍ NYLONOVÝ



Č.p.	specifikace	
19462	175 x 65 x 20 mm	1
19463	230 x 70 x 30 mm	1
19464	240 x 75 x 40 mm	1



## KLÍN ŠTÍPACÍ

Č.p.	specifikace	
19394	1000 g 35 x 180 x 40 mm	6
19395	2000 g 40 x 255 x 55 mm	6
19396	2500 g 40 x 260 x 55 mm	8



## ŠTÍPACÍ TRN SDS+

Č.p.	Specifikace	
19393	Ø 32 x 132 mm	10
19374	Ø 42 x 145 mm	10



## KLÍN ŠTÍPACÍ ČTYŘRAMENNÝ

Č.p.	specifikace	
19469	2500 g 165 x 87 mm	10

LOPATKA  
ŠIROKÁ  
NEREZ

INOX



Č.p.	specifikace	
45056	360 mm	12

LOPATKA  
ÚZKÁ  
NEREZ

INOX



Č.p.	specifikace	
45057	360 mm	12

MOTYČKA  
NEREZ

INOX



Č.p.	specifikace	
45058	270 mm	12

VYPICHOVAČ  
PLEVELE S KOLÉBKOU  
NEREZ

INOX



Č.p.	specifikace	
45059	360 mm	12

LOPATKA  
ŠIROKÁ  
NYLON

NYLON



Č.p.	specifikace	
45065	280 mm	1

LOPATKA  
ÚZKÁ  
NYLON

NYLON



Č.p.	specifikace	
45066	310 mm	1

KULTIVÁTOR  
RUČNÍ  
NYLON

NYLON



Č.p.	specifikace	
45067	290 mm	1

SAĎA  
NÁŘADÍ

HOBBY 4x



Č.p.	specifikace	
45035	240 mm	35

MOTYKA PLOCHÁ  
S NÁSADOU



Č.p.	specifikace	délka násady	
61294	140 mm	27 cm	MOQ 3
61221	násada	27 cm	1

MOTYKA SRDCOVÁ  
S NÁSADOU



Č.p.	specifikace	délka násady	
61295	140 mm	27 cm	MOQ 3
61221	násada	27 cm	1

MOTYKA PLEČKA  
S NÁSADOU



Č.p.	specifikace	délka násady	
61296	175 mm	27 cm	MOQ 3
61221	násada	27 cm	1

DRÁBEK  
SE 3 HROTY  
S NÁSADOU



Č.p.	specifikace	délka násady	
61297		27 cm	MOQ 3
61221	násada	27 cm	1



## LOPATKA SKLÁDACÍ 3 V 1

pouzdro

č.p.	specifikace	
61085	410 mm	6



## SAZEČ CIBULOVIN

INOX

č.p.	specifikace	
45040	230 mm	60



## KOLÍK SÁZECÍ "T"

č.p.	specifikace	
45038	280 mm	60



## NUŽ NA PLEVEL

č.p.	specifikace	
45079	200 mm	1



## NUŽ NA PLEVEL

č.p.	specifikace	
45080	200 mm „L“	1



## ČESÁČEK NA OVOCE



č.p.	specifikace	
45041		75



## ČESÁČEK NA OVOCE

č.p.	specifikace	
45039		50
45034	170 - 300 cm, teleskopická násada	5



## VYTRHÁVAČ PLEVELE

č.p.	specifikace	
44955	950 mm	16



## KULTIVÁTOR

č.p.	specifikace	
45042	160 x 132 mm	12



## KULTIVÁTOR

č.p.	specifikace	
44053		12
61251	160 cm násada	1



## VOZÍK SYPACÍ

ROZMĚRY

výška	111 cm
šířka	55 cm
objem zásobníku	12 l

č.p.	specifikace	
45085	12 l	1

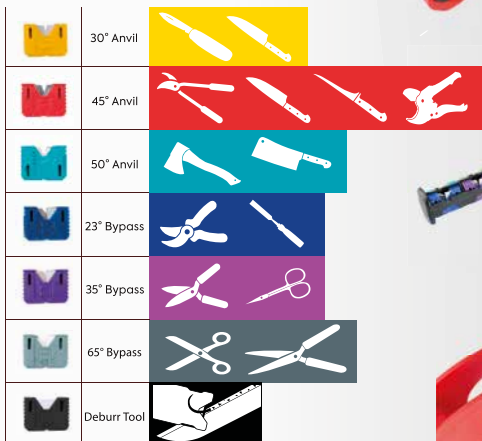
**FESTA****BROUSEK  
MULTIFUNKČNÍ 15v1**

Č.p. Specifikace

45073

Č.p. specifikace

1

**BROUSEK  
NA NOŽE A NŮŽKY**

Č.p. specifikace

45068



10

**BROUSEK  
NA NOŽE A NŮŽKY**

Č.p. specifikace

45048



20

**BROUSEK NA KOSU**

Č.p. specifikace

45046 205 x 15 mm



100

**BROUSEK OVÁLNÝ**

Č.p. specifikace

45370 250 x 33 x 18 mm



20

**BROUSEK**

Č.p. specifikace

45045 150 x 50 x 30 mm



10

**BROUSEK  
NA NOŽE A NŮŽKY**

Č.p. specifikace

16991



20

**BROUSEK  
NA NOŽE A NŮŽKY**

Č.p. specifikace

16990 Ø 50 mm



50





## STRUNA DO SEKAČKY S NYLONOVÝM STŘEDEM



Č.p.	specifikace	
45530	2 mm x 15 m	1
45531	2,4 mm x 15 m	1
45532	3 mm x 15 m	1
45533	3,15 mm x 15 m	1
45534	4 mm x 15 m	1



## STRUNA DO SEKAČKY



## STRUNA DO SEKAČKY

Č.p.	specifikace	
45520	2 mm x 162 m	10
45521	2,4 mm x 112 m	10
45528	2,7 mm x 90 m	10
45522	3 mm x 72 m	10
45525	2 mm x 162 m	10
45526	2,4 mm x 112 m	10
45529	2,7 mm x 90 m	10
45527	3 mm x 72 m	10

Č.p.	specifikace	
45500	1,3 mm x 15 m	30
45502	1,3 mm x 15 m	30
45503	1,6 mm x 15 m	20
45505	1,6 mm x 15 m	20
45506	2 mm x 15 m	12
45508	2 mm x 15 m	12
45517	2 mm x 15 m	10
45509	2,4 mm x 15 m	12
45511	2,4 mm x 15 m	12
45512	2,4 mm x 15 m	12
45518	2,4 mm x 15 m	10
45523	2,7 mm x 15 m	10
45524	2,7 mm x 15 m	10
45513	3 mm x 15 m	10
45515	3 mm x 15 m	10
45516	3 mm x 15 m	10
45519	3 mm x 15 m	10



## TEXTILIE NETKANÁ BÍLÁ

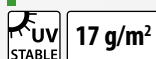

17 g/m<sup>2</sup>

Č.p.	specifikace	
45540	1,6 x 5 m	40
45541	1,6 x 10 m	40
45542	1,6 x 50 m	v roli 1
45543	1,6 x 100 m	v roli 1



## TEXTILIE NETKANÁ MULČOVACÍ ČERNÁ



50 g/m<sup>2</sup>

Č.p.	specifikace	
45550	1,6 x 5 m	50
45551	1,6 x 10 m	20
45564	3,2 x 10 m	20
45552	1,6 x 50 m	v roli 1
45553	1,6 x 100 m	v roli 1
45562	3,2 x 50 m	v roli 1
45563	3,2 x 100 m	v roli 1



## TEXTILIE NETKANÁ MULČOVACÍ HNĚDÁ



50 g/m<sup>2</sup>

Č.p.	specifikace	
45556	1,6 x 5 m	50
45557	1,6 x 10 m	20
45565	3,2 x 10 m	20
45558	1,6 x 50 m	v roli 1
45559	1,6 x 100 m	v roli 1

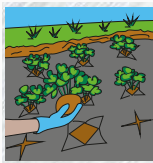

### TEXTILIE NETKANÁ S VÝSEKY NA VÝSADBU JAHODNÍKU

uv  
STABLE 45 g/m<sup>2</sup>

Č.p.	specifikace	
45535	1,6 x 5 m	18



### KOLÍK KOTVÍCÍ K UPEVNĚNÍ NETKANÉ TEXTILIE

10x

Č.p.	specifikace	
45555	11,5 cm	1

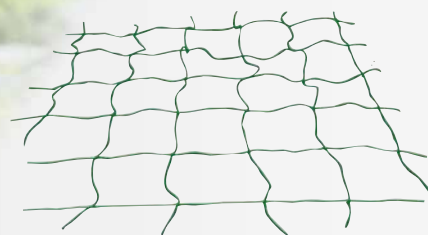
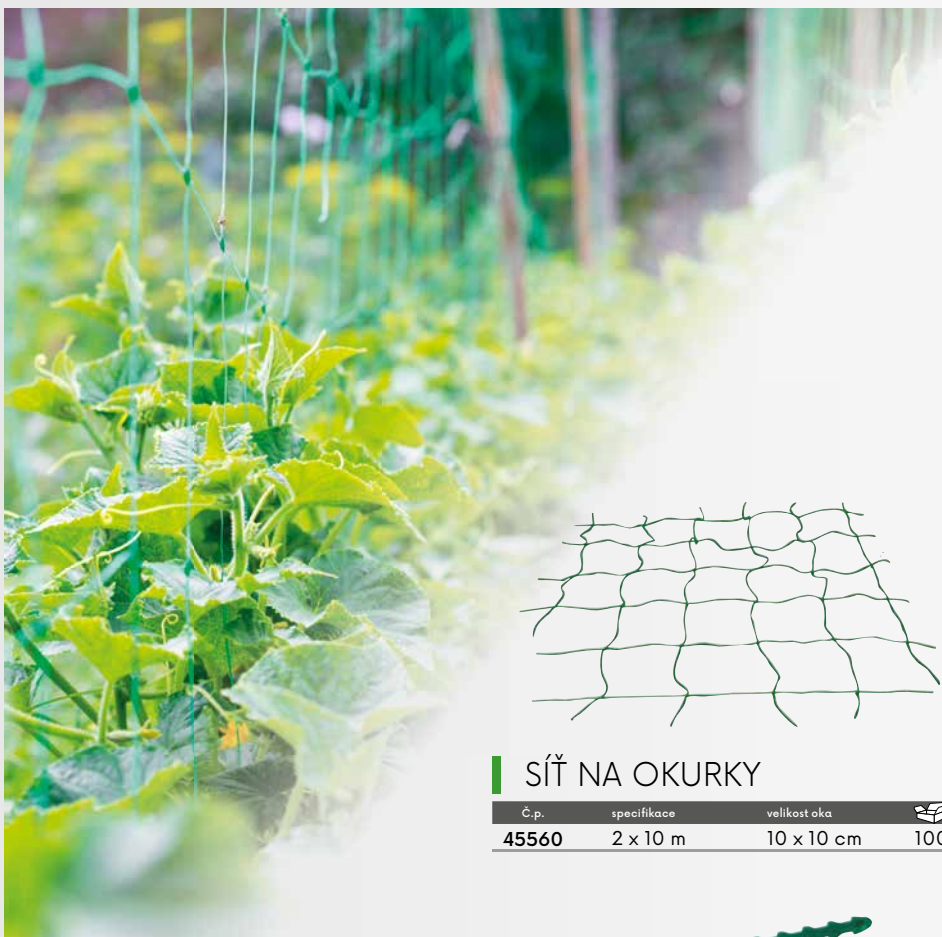

### SÍŤ NA OKURKY

Č.p.	specifikace	velikost oka	
45560	2 x 10 m	10 x 10 cm	100



### TYČ SKLOVLÁKNOVÁ

Č.p.	specifikace	
45036	180 cm Ø 7,9 mm	100



### PÁSEK VÁZACÍ ZUBATÝ

50x

Č.p.	specifikace	
23840		20



### TYČ ZAHRADNÍ POPLASTOVANÁ

Č.p.	specifikace		Č.p.	specifikace		Č.p.	specifikace	
45650	90 cm Ø 8 mm	25	45655	150 cm Ø 11 mm	25	45659	180 cm Ø 16 mm	25
45651	120 cm Ø 8 mm	25	45656	180 cm Ø 11 mm	25	45660	210 cm Ø 16 mm	25
45652	150 cm Ø 8 mm	25	45661	210 cm Ø 11 mm	25	45662	150 cm Ø 20 mm	10
45653	90 cm Ø 11 mm	25	45657	120 cm Ø 16 mm	25	45663	180 cm Ø 20 mm	10
45654	120 cm Ø 11 mm	25	45658	150 cm Ø 16 mm	25	45664	210 cm Ø 20 mm	10



### TYČ SPIRÁLOVÁ K RAJČATŮM

Č.p.	specifikace	
44041	1,2 m, Ø 5,5 mm komaxit - zelená	10
44042	1,5 m, Ø 6 mm komaxit - zelená	10
44043	1,8 m, Ø 6 mm komaxit - zelená	10
45049	1,8 m, Ø 7 mm komaxit - zelená	10
45044	1,8 m, Ø 7 mm komaxit - stříbrná	10
44050	2,2 m, Ø 7 mm komaxit - zelená	10



### SPOJKA PLASTOVÁ

MOQ  
10

Č.p.	specifikace	
45670	8 mm	10
45671	11 mm	10
45672	16 mm	10
45673	20 mm	10



## VÁZACÍ PÁSKA SUCHÝ ZIP



Č.p.	specifikace	
45471	12 mm x 5 m	1



## DRÁT VÁZACÍ PVC



Č.p.	specifikace	
45043	30 m	30



## DRÁT VÁZACÍ POGUMOVANÝ

Č.p.	specifikace	
23845	3 mm x 8 m	30
23846	4 mm x 6 m	30
23847	5 mm x 4 m	30



## VÁZACÍ PÁSKY

3x



Č.p.	specifikace	
45472	3 cm x 3 m, 3 ks	36



## VÁZACÍ PÁSKA



Č.p.	specifikace	
45473	3 cm x 50 m	60



## PODLOŽKA KLEKACÍ

Č.p.	specifikace	
45086	40 x 18 x 2 cm	50



## STOLIČKA ZAHRADNÍ SKLÁDACÍ

· oboustranná - klekátko, sedátko

Č.p.	specifikace	
45074	58 x 48 x 28 cm	4



## KOŠ SKLÁDACÍ

Č.p.	specifikace	
45093	40 x 25 x 23 cm	10



## NÁDOBA PLAST PRUŽNÁ



Č.p.	specifikace	
39192	26 l	20
39193	42 l	20



## KOŠ NA LISTÍ, SKLÁDACÍ

Č.p.	specifikace	
45047	55 x 70 cm, 3 držadla	20



## VAK NA LISTÍ

Č.p.	specifikace	
44960	200 l   60 x 60 x 55 cm	50



**FESTA®**  
AQUATIC

**FESTA®**  
AQUATIC  
PISTOLE



- 7 funkcí
- přední spoušť s pojistkou
- snadná regulace průtoku



Č.p. specifikace   
45386 12

**FESTA®**  
AQUATIC  
PISTOLE



- plynulá regulace proudu
- přední spoušť s pojistkou
- snadná regulace průtoku



Č.p. specifikace   
45388 12

**FESTA®**  
AQUATIC  
ROZSTŘIKOVAČ



- plynulá regulace proudu



Č.p. specifikace   
45389 24



**FESTA®**  
AQUATIC  
SADA  
S ROZSTŘIKOVAČEM

- plynulá regulace proudu





Č.p. specifikace   
45385 4 ks 12





**FESTA®**  
AQUATIC  
SPOJKA



  
1/2" Č.p. specifikace   
45390 24



**FESTA®**  
AQUATIC  
RYCHLOSPOJKA



  
1/2" Č.p. specifikace   
45392 24



**FESTA®**  
AQUATIC  
STOP  
RYCHLOSPOJKA



  
1/2" Č.p. specifikace   
45394 24

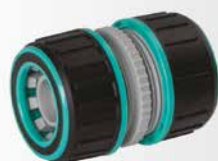

**FESTA®**  
AQUATIC  
SPOJKA



  
3/4" Č.p. specifikace   
45391 24



**FESTA®**  
AQUATIC  
RYCHLOSPOJKA



  
3/4" Č.p. specifikace   
45393 24

**FESTA®**  
AQUATIC  
STOP  
RYCHLOSPOJKA



  
3/4" Č.p. specifikace   
45395 24

## FESTA AQUATIC ADAPTÉR



Č.p. 45396      specifikace 24



**NEW**

## FESTA AQUATIC

### HADICE ZAHRADNÍ PROFI



Č.p.	specifikace	
45372	1/2" 25 m	1
45373	1/2" 50 m	1
45374	3/4" 25 m	1
45375	3/4" 50 m	1
45376	1" 25 m	1
45377	1" 50 m	1



## FESTA AQUATIC

### ZAVLAŽOVAČ VÝKYVNÝ

· 19 trysek, z toho 8 vypínatelných



Č.p. 45398      specifikace 6

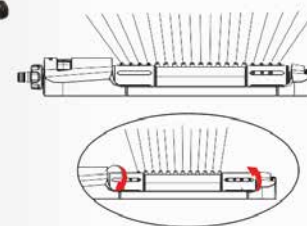

## FESTA AQUATIC

### ZAVLAŽOVAČ ROTAČNÍ

· nastavitelná ramena s tryskami



Č.p. 45399      specifikace 12



## FESTA AQUATIC

### ROZDĚLOVAČ 2 CESTNÝ

· plynulá regulace průtoku



Č.p. 45400      specifikace 6



## FESTA AQUATIC

### ROZDĚLOVAČ 4 CESTNÝ

· plynulá regulace průtoku



Č.p. 45401      specifikace 6



## ROSA PISTOLE

- 10 funkcí
- přední spoušť s pojistkou

0,7 bar min  
5,5 bar max

Č.p. specifikace

45124



12



## ROSA PISTOLE

- 10 funkcí
- spoušť s pojistkou
- snadná regulace průtoku

0,7 bar min  
5,5 bar max

Č.p. specifikace

45125



12



# ROSA

## Watering system



## ROSA PISTOLE

- 7 funkcí
- spoušť s pojistkou

0,7 bar min  
5,5 bar max

Č.p. specifikace

45126



12

## ROSA PISTOLE DELUX

- 7 funkcí
- spoušť s pojistkou
- snadná regulace průtoku

0,7 bar min  
5,5 bar max

Č.p. specifikace

45123

kovová



12



## ROSA PISTOLE

- 6 funkcí
- spoušť s pojistkou
- snadná regulace průtoku

0,7 bar min  
5,5 bar max

Č.p. specifikace

45117



12



## ROSA PISTOLE DELUX

- 6 funkcí
- spoušť s pojistkou
- snadná regulace průtoku

0,7 bar min  
5,5 bar max

Č.p. specifikace

45118

kovová hlavice



12



## ROSA PISTOLE

- 5 funkcí
- spoušť s pojistkou
- snadná regulace průtoku

0,7 bar min  
5,5 bar max

Č.p. specifikace

45110



12



## ROSA PISTOLE

- pistole různocvá
- snadná regulace průtoku

0,7 bar min  
5,5 bar max

Č.p. specifikace

45116



12



## ROSA PISTOLE

- kovová hlavice
- spoušť s pojistkou
- snadná regulace průtoku

0,7 bar min  
5,5 bar max

Č.p. specifikace

45120

12



## ROSA PISTOLE

- spoušť s pojistkou
- snadná regulace průtoku

0,7 bar min  
5,5 bar max

Č.p. specifikace

45115

12



## ROSA PISTOLE

- kovová
- spoušť s pojistkou
- snadná regulace průtoku

0,7 bar min  
5,5 bar max

Č.p. specifikace

45122

kovová

12



## ROSA PISTOLE SADA

- spoušť s pojistkou
- snadná regulace průtoku

0,7 bar min  
5,5 bar max

Č.p. specifikace

45114

1/2 rychlospojka

12



## ROSA PISTOLE

- spoušť s pojistkou
- snadná regulace průtoku

0,7 bar min  
5,5 bar max

Č.p. specifikace

45111

12



## ROSA PISTOLE SADA

- 6 funkcí
- spoušť s pojistkou
- snadná regulace průtoku

0,7 bar min  
5,5 bar max

Č.p. specifikace

45181

12



## ROSA POSTŘIKOVACÍ HUBICE

- plynulá regulace proudu

10 bar max

Č.p. specifikace

45214

48



## ROSA ROZSTŘIKOVAČ

- proudnicový, klasické připojení

0,7 bar min  
5,5 bar max

Č.p. specifikace

45112

32



## ROSA ROZSTŘIKOVAČ

- plynulá regulace proudu

0,7 bar min  
5,5 bar max

Č.p. specifikace

45113

60



## ROSA SOUPRAVA S ROZSTŘIKOVAČEM

- plynulá regulace proudu

0,7 bar min  
5,5 bar max

Č.p. specifikace

45180

12



**ROSA**  
SPOJKA



Č.p. specifikace   
45140 60



**ROSA**  
RYCHLOSPOJKA



Č.p. specifikace   
45142 60



**ROSA**  
STOP  
RYCHLOSPOJKA



Č.p. specifikace   
45138 60



**ROSA**  
SPOJKA



Č.p. specifikace   
45296  MOQ 20



**ROSA**  
RYCHLOSPOJKA





Č.p. specifikace   
45298  MOQ 20



**ROSA**  
STOP  
RYCHLOSPOJKA



Č.p. specifikace   
45294  MOQ 20



**ROSA**  
SPOJKA



Č.p. specifikace   
45141 60



**ROSA**  
RYCHLOSPOJKA



Č.p. specifikace   
45143 60



**ROSA**  
STOP  
RYCHLOSPOJKA



Č.p. specifikace   
45139 60



**ROSA**  
SPOJKA



Č.p. specifikace   
45297  MOQ 20



**ROSA**  
RYCHLOSPOJKA





Č.p. specifikace   
45299  MOQ 20



**ROSA**  
STOP  
RYCHLOSPOJKA



Č.p. specifikace   
45295  MOQ 20



**ROSA**  
REDUKCE 1/2" - 3/4"



Č.p. specifikace   
45213 1/2" - 3/4" 60



**ROSA**  
REDUKCE 3/4" - 1"



Č.p. specifikace   
45216 3/4" - 1" 48



**ROSA**  
SPOJKA



Č.p. specifikace   
45218 1" 48



## ROSA ADAPTÉR



Č.p.	specifikace	
45130	1/2" + 3/4"	60
45131	3/4" + 1"	60

## ROSA ADAPTÉR



Č.p.	specifikace	
45217		48

## ROSA RYCHLOSPOJKA



Č.p.	specifikace	
45219		48

## ROSA ADAPTÉR



Č.p.	specifikace	
45289	1/2" + 3/4"	MOQ 20
45290	3/4" + 1"	MOQ 20

## ROSA RYCHLOSPOJKA SADA

2x



Č.p.	specifikace	
45144		60

## ROSA SPOJOVACÍ VENTIL

s ventilem



Č.p.	specifikace	
45135		60

## ROSA ADAPTÉR



Č.p.	specifikace	
45133		60

## ROSA ADAPTÉR



Č.p.	specifikace	
45132		60

## ROSA ADAPTÉR

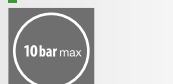

Č.p.	specifikace	
45136		60

## ROSA ADAPTÉR

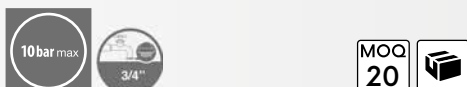

Č.p.	specifikace	
45292		MOQ 20

## ROSA ADAPTÉR

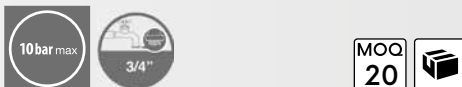

Č.p.	specifikace	
45291		MOQ 20

## ROSA ADAPTÉR



Č.p.	specifikace	
45293		MOQ 20

## ROSA ADAPTÉR

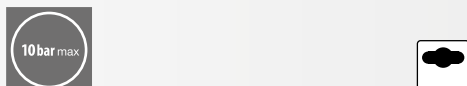

Č.p.	specifikace	
45137		60

## ROSA ADAPTÉR

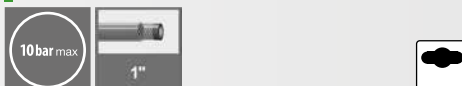

Č.p.	specifikace	
45215		48

## ROSA ADAPTÉR



Č.p.	specifikace	
45145		60

## ROSA

## ROZDVOJKA "Y"

· s ventilem

0,7 bar min  
5,5 bar max

Č.p. specifikace

45134



12



## ROSA

## PRODEJNÍ SADA

· obsah sady

45113 15 ks  
45117 10 ks  
45120 15 ks  
45132 40 ks  
45131 40 ks  
45133 40 ks  
45142 25 ks  
45143 20 ks  
45140 20 ks

225x

Č.p. specifikace

45146



1



## ROSA

ZAVLAŽOVAČ  
IMPULSNÍ

· impulsní

0,7 bar min  
5,5 bar max

Č.p. specifikace

45162



24



## ROSA

## ZAVLAŽOVAČ

· 8 funkcí

0,7 bar min  
5,5 bar max

Č.p. specifikace

45154



48



## ROSA

## ZAVLAŽOVAČ

· rotační  
· 2 ramena0,7 bar min  
5,5 bar max

Č.p. specifikace

45153



24



## ROSA

## ZAVLAŽOVAČ

· rotační  
· 3 ramena0,7 bar min  
5,5 bar max

Č.p. specifikace

45152



24



## ROSA

ZAVLAŽOVAČ  
VÝKYVNÝ

· 17 trysek

0,7 bar min  
5,5 bar max

ALU

Č.p. specifikace

45158



6

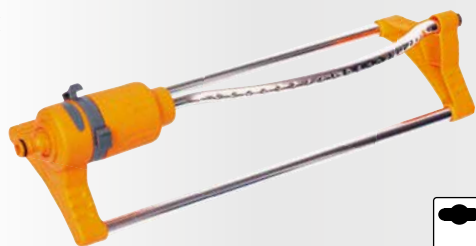

## ROSA

## ZAVLAŽOVAČ

· pyramidový

0,7 bar min  
5,5 bar max

Č.p. specifikace

45167



12



## ROSA

PODSTAVEC PRO  
IMPULSNÍ  
ZAVLAŽOVAČ0,7 bar min  
5,5 bar max

3/4"

Č.p. specifikace

45155



24



## ROSA

ZAVLAŽOVAČ  
IMPULSNÍ

· na trojnožce

0,7 bar min  
5,5 bar max

Č.p. specifikace

45163



20



## ROSA

### ZAVLAŽOVAČ

· hrotový



Č.p. specifikace 25

## ROSA

### ZAVLAŽOVAČ

· konvicový s ventilem



Č.p. specifikace 12

## ROSA

### ČASOVAČ

· 0 - 120 min.



Č.p. specifikace 24

## ROSA

### ZAVLAŽOVAČ IMPULSNÍ

· mosazný



Č.p. specifikace 12

## ROSA

### ZAVLAŽOVAČ IMPULSNÍ



Č.p. specifikace 12

## ROSA

### ZAVLAŽOVAČ IMPULSNÍ, HROTOVÝ



Č.p. specifikace 12  
45168 plastový hrot 12  
45169 kovový hrot 12

## ROSA

### ZAVLAŽOVAČ IMPULSNÍ, HROTOVÝ



Č.p. specifikace 20  
45161 plastový hrot

## ROSA

### ZAVLAŽOVAČ ROTAČNÍ, HROTOVÝ

· 3 ramena  
· dvoucestný



Č.p. specifikace 12  
45164 plastový hrot

## ROSA

### HROTOVÝ PODSTAVEC



Zn



Č.p. specifikace 12  
45159

## ROSA

### HROTOVÝ PODSTAVEC



Č.p. specifikace 12  
45179

## ROSA

### VODIČ HADICE

Č.p. specifikace 48



## ROSA

### ZAVLAŽOVAČ IMPULSNÍ



Č.p. specifikace 20  
45185

## ROSA

### ZAVLAŽOVAČ IMPULSNÍ

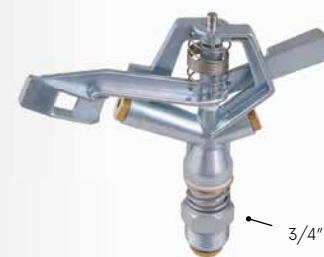

Č.p. specifikace 20  
45184

ROSA

SPOJKA  
MOSAZ
 Č.p. specifikace  
45192 48

ROSA

RYCHLOSPOJKA  
MOSAZ
 Č.p. specifikace  
45194 48

ROSA

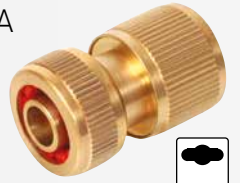
STOP  
RYCHLOSPOJKA  
MOSAZ
 Č.p. specifikace  
45190 48

ROSA

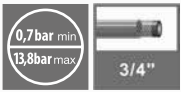
SPOJKA  
MOSAZ
 Č.p. specifikace  
45193 48

ROSA

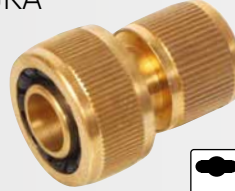
RYCHLOSPOJKA  
MOSAZ
 Č.p. specifikace  
45195 48

ROSA

STOP  
RYCHLOSPOJKA  
MOSAZ
 Č.p. specifikace  
45191 48

ROSA

ADAPTÉR  
MOSAZ
 Č.p. specifikace  
45196 s vnitřním závitem 1/2" + 3/4" 48

ROSA

ADAPTÉR  
MOSAZ
 Č.p. specifikace  
45197 s vnitřním závitem 3/4" 48

ROSA

ADAPTÉR  
MOSAZ
 Č.p. specifikace  
45199 s vnitřním závitem 1" 48

ROSA

ADAPTÉR  
MOSAZ
 Č.p. specifikace  
45198 s vnitřním závitem 3/4 + 1" 48

ROSA

ADAPTÉR  
MOSAZ
 Č.p. specifikace  
45200 s vnějším závitem 3/4 48

ROSA

POSTŘIKOVACÍ  
HUBICE  
MOSAZ
 Č.p. specifikace  
45206 stavitelná 48

ROSA

ADAPTÉR  
MOSAZ
 Č.p. specifikace  
45203 mezikus pro 2 rychlospojky 48

ROSA

ADAPTÉR  
MOSAZ
 Č.p. specifikace  
45204 mezikus pro 3 rychlospojky 48

ADAPTÉR

 Č.p. specifikace  
45211 vnitřní závít 1" 25

ROSA

SADA TĚSNĚNÍ

· pro položky  
45110, 45111, 45118, 45120, 45121, 45123,  
45125, 45126, 45130, 45131, 45132, 45134,  
45135, 45152, 45153, 45154, 45155, 45156,  
45162, 45177, 45178, 45180, 45196, 45197,  
45198

 Č.p. specifikace  
45175 1

ROSA

TĚSNĚNÍ NA SPOJKY  
A KONEKTORY

50x

 Č.p. specifikace  
45187 1

**NEW**



**ROSA**

**HADICE ZAHRADNÍ PRŮHLEDNÁ**



Č.p.	specifikace	
45342	1/2" 10 m	1
45343	1/2" 15 m	1
45344	1/2" 20 m	1
45345	1/2" 25 m	1
45346	1/2" 50 m	1
45341	3/4" 10 m	1
45347	3/4" 15 m	1
45348	3/4" 20 m	1
45349	3/4" 25 m	1
45351	3/4" 50 m	1
45352	1" 15 m	1
45353	1" 25 m	1
45354	1" 50 m	1

**NEW**



**FESTA AQUATIC**

**HADICE ZAHRADNÍ PROFI**



Č.p.	specifikace	
45372	1/2" 25 m	1
45373	1/2" 50 m	1
45374	3/4" 25 m	1
45375	3/4" 50 m	1
45376	1" 25 m	1
45377	1" 50 m	1



**ROSA**

**SPIRÁLOVÁ HADICE SADA**



Č.p.	specifikace	
45300	7,5 m	6
45301	15 m	8



**ROSA**

**DRŽÁK NA HADICI**



Č.p.	specifikace	
45178	1/2" 60 m	5



**ROSA**

**VOZÍK NA HADICI KOVOVÝ**



Č.p.	specifikace	
45183	1/2" 60 m	5



**ROSA**

**VOZÍK NA HADICI**



Č.p.	specifikace	
45177	1/2" 60 m	5

**ROSA**

**DRŽÁK NA HADICI**



Č.p.	specifikace		
45182	1/2" 40 m	4	60

**ROSA**

**NAVÍJEČ NA HADICI**

• včetně hadice 1/2" 20 m



Č.p.	specifikace		
45176		1	60



**ROSA**

**DRŽÁK HADIC**

Č.p.	specifikace	
45174		60



**NOSIČ HADIC**

• max. 30 m, 1/2" zahradní hadice

Č.p.	specifikace	
45350	max. nosnost 20 kg	1



HADICOVÁ  
SPOJKA

Č.p.	specifikace	
45220	1/2" závit 3/4"	10
45221	3/4" závit 1"	10
45222	1" závit 1"	10

HADICOVÁ  
KONCOVKA

Č.p.	specifikace	
45223	1/2" závit 3/4"	10
45224	3/4" závit 1"	10
45225	1" závit 1"	10

HADICOVÁ  
REDUKCE

Č.p.	specifikace	
45226	1/2" - 3/4" závit 1"	10
45227	1" - 3/4" závit 1"	10
45228	1" - 1/2" závit 1"	10



## ROZPRAŠOVAČ

Č.p.	specifikace	
45229		10



Č.p.	průměr	
45603	16 - 25 mm	2
45604	20 - 32 mm	2
45605	25 - 40 mm	2
45606	30 - 45 mm	2
45607	32 - 50 mm	2
45608	40 - 60 mm	2
45609	50 - 70 mm	2
45610	60 - 80 mm	2
45611	70 - 90 mm	2
45612	80 - 100 mm	2
45613	90 - 110 mm	2
45614	100 - 120 mm	2
45615	110 - 130 mm	2
45616	120 - 140 mm	2
45617	130 - 150 mm	2
45618	140 - 160 mm	2
45619	150 - 170 mm	2



Č.p.	průměr	šířka	
45623	16 - 25 mm	9 mm	2
45624	20 - 32 mm	9 mm	2
45625	25 - 40 mm	12 mm	2
45626	30 - 45 mm	12 mm	2
45627	32 - 50 mm	12 mm	2
45628	40 - 60 mm	12 mm	2
45629	50 - 70 mm	12 mm	2
45630	60 - 80 mm	12 mm	2
45631	70 - 90 mm	12 mm	2
45632	80 - 100 mm	12 mm	2
45633	90 - 110 mm	12 mm	2
45634	100 - 120 mm	12 mm	2
45635	110 - 130 mm	12 mm	2
45636	120 - 140 mm	12 mm	2
45637	130 - 150 mm	12 mm	2
45638	140 - 160 mm	12 mm	2
45639	150 - 170 mm	12 mm	2

## SPONA HADICOVÁ

Č.p.	průměr	
45600	8 - 12 mm	2
45601	10 - 16 mm	2
45602	12 - 20 mm	2

Zn

MOQ  
2

## SPONA HADICOVÁ

Č.p.	průměr	šířka	
45620	8 - 12 mm	9 mm	2
45621	10 - 16 mm	9 mm	2
45622	12 - 20 mm	9 mm	2

INOX

MOQ  
2

## VENTIL ZAHRADNÍ DVOJITÝ

Č.p.	
45105	8



## VENTIL ZAHRADNÍ

Č.p.	specifikace	
45100	1/2"	12
45101	3/4"	10
45102	1"	6



## VENTIL KULOVÝ

Č.p.	specifikace	
45106	1/2"	12
45107	3/4"	10
45108	1"	8

KONEV  
PLASTOVÁMADE IN  
EU

Č.p.	specifikace	
45280	2,5 l	10
45283	5 l	10
45285	10 l	10
45286	12 l	10
45287	14 l	10



## ROHÁČEK

Č.p.	specifikace	
45104	1/2" x 3/8"	10





## FESTA

### POSTŘIKOVAČ TLAKOVÝ ZAHRADNÍ 12 L

max. tlak	2,5 Bar
objem	12 l
délka hadice	3 m
rozměry	32 x 25 x 59 cm



Č.p.	specifikace	
45249	postřikovač tlakový zahradní 12 l	1

## FESTA

### POSTŘIKOVAČ TLAKOVÝ ZAHRADNÍ

Č.p.	specifikace	
45247	12 l	1
45248	16 l	1



Č.p.	specifikace	
45263	náhradní hadička k postřikovači	1
45251	náhradní sada těsnění	1
45254	náhradní tryska	1
45257	náhradní rukojeť	1
45261	náhradní tyč - 370 mm	1
45267	náhradní tyč 45 - 250 cm	1
45268	náhradní tyč 65 - 260 cm	1

## FESTA

### POSTŘIKOVAČ TLAKOVÝ ZAHRADNÍ

Č.p.	specifikace	
45244	3 l	6
45245	5 l	6
45246	8 l	6



Č.p.	specifikace	
45262	náhradní hadička k postřikovači	1
45250	náhradní sada těsnění	1
45253	náhradní tryska	1
45256	náhradní rukojeť	1
45260	náhradní tyč - 370 mm	1

• pro postřikovače 45244, 45245, 45246



• pro postřikovače 45247, 45248

93 - 250 cm



### TYČ K POSTŘIKOVAČI TELESKOPICKÁ

Č.p.	typ		
45267	45 - 250 cm	inox	1
45268	65 - 260 cm	fiberglass	1

### TYČ K POSTŘIKOVAČI TELESKOPICKÁ

Č.p.	specifikace	
45269		1



### NÁHRADNÍ HADIČKA K POSTŘIKOVAČI

Č.p.	typ	
45263	pro postřikovač 45247, 45248	1
45262	pro postřikovač 45244, 45245, 45246	1



### ZVON HERBICIDNÍ

• pro postřikovače 45247, 45248, 45249

Č.p.	velikost	délka	šířka	výška	
45265	malý	230 mm	90 mm	130 mm	1
45266	velký	370 mm	140 mm	200 mm	1



**FESTA**

POSTŘIKOVAČ  
RUČNÍ  
TLAKOVÝ



Č.p.	typ	
45242	1,5 l	20
45241	2 l	20

POSTŘIKOVAČ RUČNÍ



Č.p.	typ	
45239	0,5 l	1
45240	0,7 l	1



**ROSA**  
SPRCHA



Č.p.	specifikace	
45171	stavitelná	12



**ROSA**  
SPRCHA



Č.p.	specifikace	
45170	3 nohy	6



**ROSA**  
SPRCHA  
RUČNÍ



Č.p.	specifikace	
45172	s ventilem	12
45173	10 funkcí	12



**FESTA**<sup>®</sup>

system click  
ON - OFF



system click  
ON - OFF



system click  
ON - OFF

**FESTA**

HRÁBĚ PLASTOVÉ

Č.p.	počet lamel	šířka	výška	
45327	13	24 cm	200 cm	12

**FESTA**

HRÁBĚ PLASTOVÉ

Č.p.	počet lamel	šířka	
45325	12	41 cm	12



system click  
ON - OFF



system click  
ON - OFF

**FESTA**

HRÁBĚ PLASTOVÉ

Č.p.	počet lamel	šířka	výška	
45328	23	48 cm	28 cm	12

**FESTA**

HRÁBĚ PLASTOVÉ

Č.p.	počet lamel	šířka	
45326	18	58 cm	12



system click  
ON - OFF



system click  
ON - OFF

**FESTA**

HRÁBĚ PLASTOVÉ

Č.p.	počet lamel	šířka	výška	
45329	35	76 cm	31 cm	1

**FESTA**

SMETÁK

Č.p.	specifikace	
45323	37 cm	16

**FESTA**

NÁSADA HLINÍKOVÁ

ALU

Č.p.	specifikace	
45330	161 cm	24
45331	100 cm	24



system click  
ON - OFF

**FESTA**

HRÁBĚ KOVOVÉ  
STAVITELNÉ,  
TELESKOPICKÉ



Zn

Č.p.	počet lamel	rozsah	
44965	15	20 - 59 cm	12

HRÁBĚ KOVOVÉ STAVITELNÉ



Zn

Č.p.	počet lamel	váha	rozsah	
45050	15	1200 g	20 - 59 cm	25

**FESTA**

HRÁBĚ KOVOVÉ LAMELOVÉ

· pružinová ocel



Č.p.	počet lamel	šířka	
45071	22	55 cm	1

**FESTA**

HRÁBĚ KOVOVÉ  
LAMELOVÉ,  
S NÁSADOU

MOQ  
3

Č.p.	šířka	délka násady	
61150	55 cm	160 cm	3



HRÁBĚ KOVOVÉ LAMELOVÉ

Č.p.	počet lamel	šířka	
45051	22	40 cm	60

HRÁBĚ KOVOVÉ  
LAMELOVÉ,  
S NÁSADOU

MOQ  
3

Č.p.	šířka	délka násady	
61130	40 cm	160 cm	3



HRÁBĚ KOVOVÉ DRÁTOVÉ

Č.p.	počet lamel	šířka	
45052	22	45 cm	36

HRÁBĚ KOVOVÉ  
S NÁSADOU

MOQ  
3

Č.p.	šířka	délka násady	
61131	45 cm	160 cm	3

## HRÁBĚ PLASTOVÉ



Č.p.	počet lamel	šířka	
45320	24	60 cm	10

## HRÁBĚ PLASTOVÉ S NÁSADOU



Č.p.	počet lamel	šířka	délka násady	
61132	24	60 cm	160 cm	3

MOQ  
3

## HRÁBĚ PLASTOVÉ



Č.p.	počet lamel	šířka	
45055	22	50 cm	10

## HRÁBĚ PLASTOVÉ S NÁSADOU



Č.p.	počet lamel	šířka	délka násady	
61133	22	50 cm	160 cm	3

MOQ  
3

## HRÁBĚ PLASTOVÉ



Č.p.	počet lamel	šířka	
45321	23	40 cm	20

## HRÁBĚ PLASTOVÉ S NÁSADOU



Č.p.	počet lamel	délka násady	
61134	23	160 cm	3

MOQ  
3

## HRÁBĚ PLASTOVÉ



Č.p.	počet lamel	šířka	
45054	23	40 cm	10

## HRÁBĚ PLASTOVÉ S NÁSADOU



Č.p.	počet lamel	šířka	délka násady	
61135	23	40 cm	160 cm	3

MOQ  
3

## HRÁBĚ PLASTOVÉ



Č.p.	počet lamel	šířka	
45053	16	58 cm	35

## HRÁBĚ PLASTOVÉ S NÁSADOU



Č.p.	počet lamel	šířka	délka násady	
61141	16	58 cm	160 cm	3

MOQ  
3

### HRÁBĚ PLASTOVÉ SE ZAROVNÁVACÍ HRANOU



Č.p.	počet zubů	šířka	
45070	14	41 cm	4

### HRÁBĚ PLASTOVÉ SE ZAROVNÁVACÍ HRANOU, S NÁSADOU

**MOQ**  
3

Č.p.	počet zubů	šířka	délka násady	
61142	14	41 cm	160 cm	3

### HRÁBĚ KOVOVÉ

Č.p.	počet zubů	šířka	
61030	10	24 cm	24
61031	12	29 cm	24
61032	14	34 cm	24
61033	16	40 cm	24



### HRÁBĚ KOVOVÉ S NÁSADOU

Č.p.	počet zubů	šířka	délka násady	
61060	10	24 cm	160 cm	3
61061	12	29 cm	160 cm	3
61062	14	34 cm	160 cm	3
61063	16	40 cm	160 cm	3

**MOQ**  
3

### HRÁBĚ VERTIKUTAČNÍ KOVOVÉ

· kladívkový lak

Č.p.	počet zubů	šířka	
61045	12	30 cm	25
61046	14	39 cm	25
61047	16	45 cm	25



### HRÁBĚ VERTIKUTAČNÍ S NÁSADOU

Č.p.	počet zubů	šířka	délka násady	
61143	12	30 cm	160 cm	3
61144	14	39 cm	160 cm	3
61145	16	45 cm	160 cm	3

· kladívkový lak

**MOQ**  
3

### HRÁBĚ VERTIKUTAČNÍ

Č.p.	počet zubů	šířka	
61048	11   21	35 cm	12



### HRÁBĚ VERTIKUTAČNÍ S NÁSADOU

Č.p.	počet zubů	šířka	délka násady	
61146	11   21	35 cm	160 cm	3

**MOQ**  
3

### HRÁBĚ KOVOVÉ S NÁSADOU FIBERGLASS

Č.p.	počet zubů	šířka	délka násady	
61034	14	34 cm	160 cm	3

**MOQ**  
3

**FESTA**

RÝČ ŠPIČATÝ



Č.p.	specifikace	délka násady	
61006	19 x 28 cm	120 cm	5

**FESTA**

RÝČ ŠPIČATÝ MALÝ

· vhodný pro práci ve skleníku



Č.p.	specifikace	délka násady	
61008	19 x 28 cm	85 cm	5

**FESTA**

RÝČ OBLÝ



Č.p.	specifikace	délka násady	
61005	20 x 29 cm	120 cm	5

**FESTA**



**FESTA**

RÝČ OBLÝ PRODLOUŽENÝ

· pro postavy vyšší 180 cm

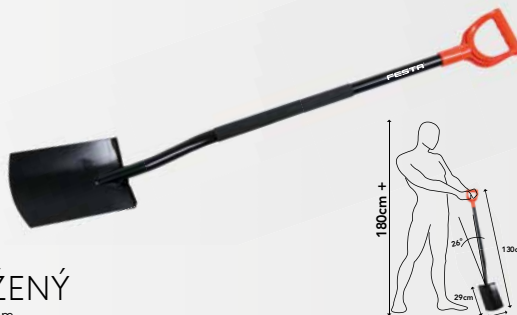

Č.p.	specifikace	délka násady	
61157	20 x 29 cm	130 cm	5

**FESTA**

RÝČ ŠPIČATÝ PRODLOUŽENÝ

· pro postavy vyšší 180 cm



Č.p.	specifikace	délka násady	
61158	19 x 28 cm	130 cm	5

**FESTA**

LOPATA STANDARD



Č.p.	specifikace	délka násady	
61155	24 x 29 cm	120 cm	5

**FESTA**

VIDLE



Č.p.	specifikace	délka násady	
61156	19 x 28 cm	130 cm	5

**FESTA**

RYCÍ VIDLE



Č.p.	specifikace	délka násady	
61007	18 x 28 cm	130 cm	5

RYCÍ VIDLE NÁSADA FIBERGLASS



Č.p.	specifikace	délka násady	
61010	18 x 30 cm	95 cm	12

RÝČ ŠPIČATÝ NÁSADA FIBERGLASS



Č.p.	specifikace	délka násady	
61029	19 x 30 cm	105 cm	12

RÝČ OBLÝ NÁSADA FIBERGLASS



Č.p.	specifikace	délka násady	
61015	19 x 30 cm	105 cm	12



### LOPATA HLINÍKOVÁ S NÁSADOU

· buková násada kolínko

Č.p.	specifikace	délka násady	MOQ 3
61057	26 x 29 cm	130 cm	3
61056	34 x 30 cm	130 cm	3



### LOPATA HLINÍKOVÁ

Č.p.	specifikace	MOQ 3
61026	26 x 29 cm	10
61025	34 x 30 cm	10



### LOPATA UHELNÁ S NÁSADOU

Č.p.	specifikace	délka násady	MOQ 3
61089	35 x 35 cm	130 cm	3



### LOPATA UHELNÁ

Č.p.	specifikace	MOQ 3
61021	35 x 35 cm	10



### LOPATA SRDCOVKA S NÁSADOU

· kladivkový lak  
· buková násada kolínko

Č.p.	specifikace	délka násady	MOQ 3
61050	26 x 28 cm	130 cm	3



### LOPATA SRDCOVKA

Č.p.	specifikace	MOQ 3
61000	26 x 28 cm	12



### LOPATA SRDCOVKA S NÁSADOU

· buková násada kolínko

Č.p.	specifikace	délka násady	MOQ 3
61088	26 x 28 cm	130 cm	3



### LOPATA SRDCOVKA

Č.p.	specifikace	MOQ 3
61020	26 x 28 cm	12



### LOPATA STANDARD S NÁSADOU

· kladivkový lak  
· buková násada kolínko

Č.p.	specifikace	délka násady	MOQ 3
61051	24 x 29 cm	130 cm	3

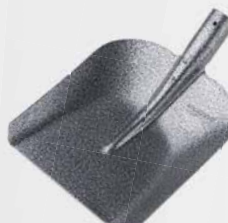

### LOPATA STANDARD

Č.p.	specifikace	MOQ 3
61001	24 x 29 cm	12





## LOPATA STANDARD

Č.p.	specifikace	
61022	24 x 29 cm	12



## LOPATA STANDARD S NÁSADOU

• buková násada kolínko

MOQ  
3

Č.p.	specifikace	délka násady	
61090	24 x 29 cm	130 cm	3
61053	24 x 29 cm	130 cm "T", násada	3



## LOPATA HOLŠTÝNSKÁ

Č.p.	specifikace	
61058	25 x 27 cm	12



## LOPATA HOLŠTÝNSKÁ S NÁSADOU

• buková násada kolínko

MOQ  
3

Č.p.	specifikace	délka násady	
61059	25 x 27 cm	130 cm	3



## LOPATA ÚZKÁ

• kladívkový lak

Č.p.	specifikace	
61002	19 x 27 cm	12



## LOPATA ÚZKÁ S NÁSADOU

• kladívkový lak  
• buková násada kolínko

MOQ  
3

Č.p.	specifikace	délka násady	
61052	19 x 27 cm	130 cm	3



## LOPATA ÚZKÁ

Č.p.	specifikace	
61024	19 x 27 cm	12



## LOPATA ÚZKÁ S NÁSADOU

• buková násada kolínko

MOQ  
3

Č.p.	specifikace	délka násady	
61054	19 x 27 cm	130 cm	3



## LOPATA PLASTOVÁ

Č.p.	specifikace	
61027	24 x 26 cm	12



### RÝČ ŠPIČATÝ S "T,, NÁSADOU

· kladivkový lak

MOQ  
3

Č.p.	specifikace	délka násady	
61161	22 x 30 cm	90 cm	3



### RÝČ ŠPIČATÝ

· kladivkový lak

Č.p.	specifikace	
61004	22 x 30 cm	12



### RÝČ ŠPIČATÝ S "T,, NÁSADOU

MOQ  
3

Č.p.	specifikace	délka násady	
61097	19 x 30 cm	90 cm	3



### RÝČ ŠPIČATÝ

Č.p.	specifikace	
61019	22 x 30 cm	12



### RÝČ KOVANÝ, ŠPIČATÝ S "T,, NÁSADOU

Č.p.	specifikace	délka násady	MOQ
61162	22 x 25 cm	90 cm	3
61223	násada	90 cm	1

### RÝČ KOVANÝ, ŠPIČATÝ

Č.p.	specifikace	
61013	22 x 25 cm	12



### RÝČ OBLÝ S "T,, NÁSADOU

· kladivkový lak

MOQ  
3

Č.p.	specifikace	délka násady	
61163	21 x 30 cm	90 cm	3

### RÝČ OBLÝ

· kladivkový lak

Č.p.	specifikace	
61003	21 x 30 cm	12



**RÝČ OBLÝ**

Č.p.	specifikace	
61018	21 x 30 cm	12

**RÝČ OBLÝ S "T" NÁSADOU**

 MOQ  
3

Č.p.	specifikace	délka násady	
61098	21 x 30 cm	90 cm	3

**RÝČ ŠTYCHAR**

Č.p.	specifikace	
61014	14 x 37 cm	12

**RÝČ ŠTYCHAR S "T" NÁSADOU**

Č.p.	specifikace	délka násady	
61164	14 x 37 cm	90 cm	MOQ 3
61203	násada	90 cm	1

**VIDLE NA SENO**

Č.p.	specifikace	
61009	20 x 32 cm	12

**VIDLE NA SENO S NÁSADOU**

• buková násada kolínko

 MOQ  
3

Č.p.	specifikace	délka násady	
61165	20 x 32 cm	90 cm	3

**VIDLE RYCÍ KOVANÉ**

Č.p.	specifikace	
61012	22 x 30 cm	12

**VIDLE RYCÍ KOVANÉ S "T" NÁSADOU**

Č.p.	specifikace	délka násady	
61166	22 x 30 cm	90 cm	MOQ 3
61222	násada	90 cm	1

**RYCÍ VIDLE**

Č.p.	specifikace	
61044	20 x 30 cm	12



**VIDLE RYCÍ S "T" NÁSADOU**

Č.p.	specifikace	délka násady	
61028	20 x 30 cm	90 cm	MOQ 3
61209	násada	90 cm	1

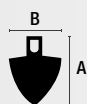

### MOTYKA KOVANÁ, ŠPIČATÁ S NÁSADOU

Č.p.	specifikace	délka násady	MOQ	
61111	0,4 kg	120 cm	3	
61112	0,6 kg	120 cm	3	
61224	násada	120 cm	1	



### MOTYKA KOVANÁ, ŠPIČATÁ

Č.p.	specifikace	A	B	
61035	0,4 kg	18 cm	12,5 cm	1
61036	0,6 kg	23 cm	16 cm	30



### MOTYKA PLOCHÁ, KOVANÁ S NÁSADOU

Č.p.	specifikace	délka násady	MOQ	
61114	0,6 kg	120 cm	3	
61224	násada	120 cm	1	

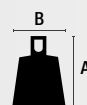

### MOTYKA KOVANÁ, PLOCHÁ

Č.p.	specifikace	A	B	
61038	0,6 kg	16,5 cm	13,5 cm	20



### MOTYKA S NÁSADOU

MOQ  
3

Č.p.	specifikace	délka násady	
61290	75 mm	120 cm	3
61291	125 mm	120 cm	3
61292	175 mm	120 cm	3

### MOTYKA

Č.p.	specifikace	
61067	75 mm	1
61068	125 mm	1
61069	175 mm	1



### MOTYKA SRDCOVÁ S NÁSADOU

MOQ  
3

Č.p.	specifikace	délka násady	
61293	140 mm	120 cm	3

### MOTYKA SRDCOVÁ

Č.p.	specifikace	
61070	140 mm	40



### KRUMPÁČ KOVANÝ S NÁSADOU

MOQ  
3

Č.p.	specifikace	délka násady	
61121	1,5 kg	95 cm	3
61042	2,5 kg	95 cm	3

### KRUMPÁČ KOVANÝ

Č.p.	specifikace	
61120	1,5 kg	6
61040	2,5 kg	6



**FESTA**

SHRNOVAČ SNĚHU



Č.p.	specifikace	
60006	46 x 34 cm	12
60206	46 x 34 cm, složený	1

**FESTA**

SHRNOVAČ SNĚHU



Č.p.	specifikace	
60008	50 x 34 cm	12
60208	50 x 34 cm, složený	1

SHRNOVAČ SNĚHU



MADE IN EU

Č.p.	specifikace	
60001	48 x 40 cm	10
60201	48 x 40 cm, složený	1

SHRNOVAČ SNĚHU



ALU

Č.p.	specifikace	
60012	50 x 38 cm	12
60212	50 x 38 cm, složený	1



SEKÁČ NA LED

Č.p.	specifikace		MOQ
60022	20 cm	3	3

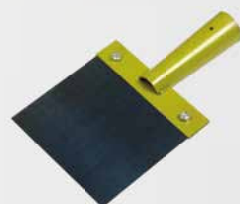

SEKÁČ NA LED

Č.p.	specifikace	
60018	15 cm	20
60019	20 cm	24
60020	30 cm	20
61201	násada 130 cm	10



POSYPOVÁ SŮL

Č.p.	specifikace	
43300	10 kg	1
43301	25 kg	1



**FESTA****LOPATKA PLECHOVÁ - ZESÍLENÁ**

Č.p.	specifikace	
52176	22 x 23 cm	24

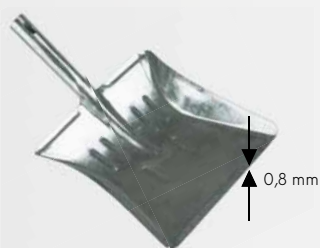
**LOPATKA PLECHOVÁ****Zn**

Č.p.	specifikace	
52175	22 x 23 cm	50

**SMETÁČEK S LOPATKOU****MADE IN EU**

Č.p.	specifikace	
52168		26

**SMETÁČEK S LOPATKOU****MADE IN EU**

Č.p.	specifikace	
52173		26

**KARTÁČ OCELOVÝ NA ČIŠTĚNÍ SPÁR S NÁSADOU**

Č.p.	délka násady	
52198	140 cm	1

**SMETÁČEK****MADE IN EU**

Č.p.	specifikace	
52119	29 cm	24

**SMETÁK S NÁSADOU****MADE IN EU****MOQ 3**

Č.p.	specifikace	
52197	30 cm 120 cm dřevěná	3

**SMETÁK****MADE IN EU**

Č.p.	specifikace	
52108	30 cm hrubý závit	25
61172	násada 120 cm hrubý závit	1

**KOŠTĚ ČIROKOVÉ S NÁSADOU**

Č.p.	specifikace	
52135	145 cm 5x prošívané	1

**system click ON - OFF****FESTA****SMETÁK**

Č.p.	specifikace	
45323	37 cm	16





## SMETÁK



Č.p.	specifikace	
52101	30 cm	10
52102	40 cm	10
52103	50 cm	10
52104	60 cm	10
52105	80 cm	10



## SMETÁK S NÁSADOU



Č.p.	specifikace	délka násady	
52190	30 cm	150 cm	3
52191	40 cm	150 cm	3
52192	50 cm	150 cm	3
52193	60 cm	150 cm	3
52194	80 cm	150 cm	3



## SÁLOVÝ SMETÁK



Č.p.	specifikace	
52160	40 cm	10
52161	50 cm	10
52162	60 cm	10
52163	70 cm	10
52164	80 cm	10



## SÁLOVÝ SMETÁK S NÁSADOU



Č.p.	specifikace	délka násady	
52185	40 cm	150 cm	3
52186	50 cm	150 cm	3
52187	60 cm	150 cm	3
52188	70 cm	150 cm	3
52189	80 cm	150 cm	3



## SMETÁK



Č.p.	specifikace	
52114	28 cm hrubý závit	1



## SMETÁK S NÁSADOU



Č.p.	specifikace	délka násady	
52116	28 cm s násadou 130 cm	3	



## SMETÁK



Č.p.	specifikace	
52113	30 cm hrubý závit	26
52115	30 cm bez závitů	26



## SMETÁK S NÁSADOU



Č.p.	specifikace	délka násady	
52195	30 cm 150 cm dřevěná	3	
52196	30 cm 130 cm ALU	3	



## STĚRKA S GUMOU

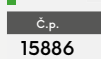

Č.p.	specifikace	
15886	450 mm násada Ø 23 mm	48
15887	600 mm násada Ø 23 mm	48
15888	750 mm násada Ø 23 mm	32



## ULIČOVÝ SMETÁK S NÁSADOU



Č.p.	specifikace	
52109	25 cm 120 cm dřevěná	12

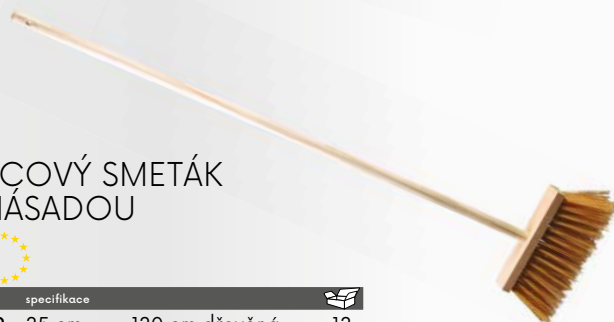



### FESTA KARTÁČ OCELOVÝ

Č.p.	specifikace		
22135	6 x 19 cm	bez násady	8
22137	6 x 19 cm	s násadou 140 cm	MOQ 3



### FESTA KARTÁČ NYLONOVÝ

Č.p.	specifikace		
22136	6 x 19 cm	bez násady	8
22138	6 x 19 cm	s násadou 140 cm	MOQ 3



### ČISTÍCÍ MOP

Č.p.	specifikace	
52110	30 cm	16



### NÁHRADNÍ MOP

Č.p.	specifikace	
52111	30 cm	1



### FESTA NÁSADA HLINÍKOVÁ

Č.p.	specifikace	
45330	161 cm	24
45331	100 cm	24

system click  
ON - OFF

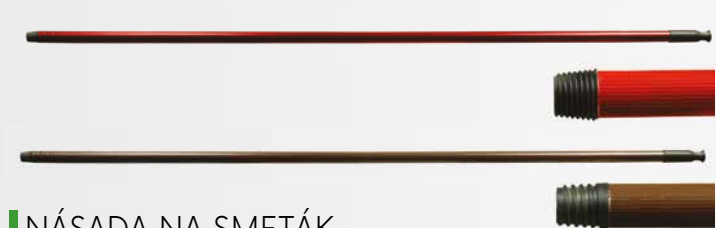

### NÁSADA NA SMETÁK

Č.p.	specifikace	
52126	130 cm, hrubý závit	1

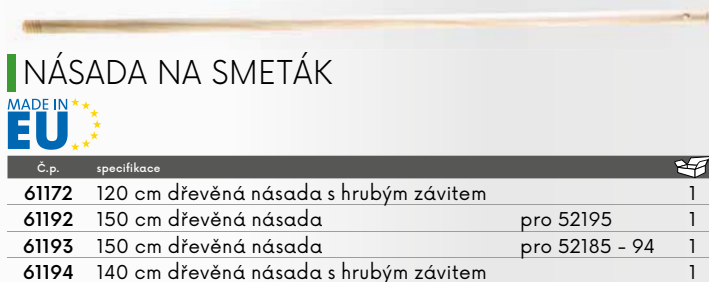

### NÁSADA NA SMETÁK

Č.p.	specifikace	
61172	120 cm dřevěná násada s hrubým závitem	1
61192	150 cm dřevěná násada pro 52195	1
61193	150 cm dřevěná násada pro 52185 - 94	1
61194	140 cm dřevěná násada s hrubým závitem	1



### NÁSADA NA SMETÁK

Č.p.	specifikace		Č.p.	specifikace	
61171	1,2 m	1	61175	1,6 m	1
61173	1,4 m	1	61176	1,7 m	1
61174	1,5 m	1	61177	1,8 m	1



### NÁSADA NA VIDLE A LOPATU - KOLÍNKO

Č.p.	specifikace	
61200	130 cm	10

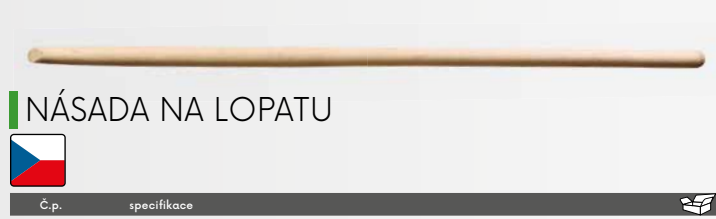

### NÁSADA NA LOPATU

Č.p.	specifikace	
61201	130 cm, rovná	10



### NÁSADA NA RÝČ "T"

Č.p.	specifikace	
61208	90 cm	10



### NÁSADA NA LOPATU "T"

Č.p.	specifikace	
61202	130 cm, rovná	10



## NÁSADA NA ZEDNICKOU NABĚRAČKU



Č.p.	specifikace	
61215	160 cm	10



## NÁSADA NA KRUMPÁČ



Č.p.	specifikace	
61204	95 cm, úzká (pro 61120)	10
61205	95 cm	10



## NÁSADA NA PLASTOVÉ HRÁBĚ



Č.p.	specifikace	
61195	120 cm	10



## NÁSADA NA HRÁBĚ



Č.p.	specifikace	vhodné pro	
61250	160 cm	45051, 61048	20
61251	160 cm	45052	20
61252	160 cm	45320	20
61253	160 cm	45053	20
61254	160 cm	45054	20
61255	160 cm	45070	20
61256	160 cm	45055	20



## NÁSADA NA RÝČ "Y"



Č.p.	specifikace	
61207	100 cm	10



## NÁSADA NA MOTYKU



Č.p.	specifikace	
61219	120 cm	10



## NÁSADA NA ŽELEZNÉ HRÁBĚ



Č.p.	specifikace	
61183	150 cm	10
61184	160 cm	10
61189	170 cm	10
61190	180 cm	10



## PLASTOVÁ RUČKA "Y" NA NÁSADU

Č.p.	specifikace	
61230		10

61079



120 cm

80 cm

Č.p.	specifikace
61005	15
61006	15
61050	15
61051	15
61052	15
61079	1
61097	15
61098	15

61077



• ilustrační foto

## REKLAMNÍ STOJAN NA LOPATY A RÝČE

Č.p.	specifikace	
61077	stojan s paletou osazený	1
61079	stojan s paletou	1

## DRŽÁK ZAHRADNÍHO NÁŘADÍ

5x

Č.p.	specifikace	
51184		12



• otočné gumové válečky



## DRŽÁK ZAHRADNÍHO NÁŘADÍ

Č.p.	specifikace	
51185	45 cm	15

• ilustrační foto



## SÍŤ PROTI HMYZU

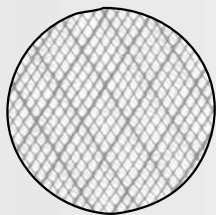

Č.p.	specifikace	
40100	1 x 25 m - PE bílá	1
40120	1,2 x 25 m - PE bílá	1

## SÍŤ PROTI HMYZU

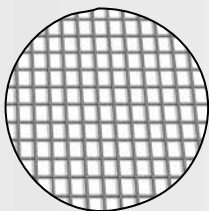

**ALU** **Zn**

Č.p.	specifikace	
42101	1 x 30 m - ALUMINIUM	2
42103	1 x 30 m - galvanizovaný drát	2

## SÍŤ PROTI HMYZU

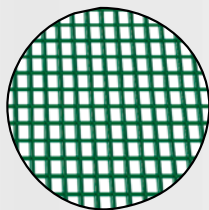

Č.p.	specifikace	
42102	1 x 30 m - zeleně lakovaný ocelový drát	2

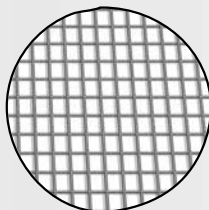
SÍŤ PROTI HMYZU  
SKLOVLÁKNO

Č.p.	specifikace		
41083	0,8 x 30 m	bílá	6
41103	1 x 30 m	bílá	6
41123	1,2 x 30 m	bílá	6
41153	1,5 x 30 m	bílá	6

Č.p.	specifikace		
41082	0,8 x 30 m	bílá-šedá	6
41102	1 x 30 m	bílá-šedá	6
41122	1,2 x 30 m	bílá-šedá	6
41152	1,5 x 30 m	bílá-šedá	6

Č.p.	specifikace		
41050	0,5 x 30 m	šedá	6
41080	0,8 x 30 m	šedá	6
41100	1 x 30 m	šedá	6
41120	1,2 x 30 m	šedá	6
41150	1,5 x 30 m	šedá	6

Č.p.	specifikace		
41081	0,8 x 30 m	černá	6
41101	1 x 30 m	černá	6
41121	1,2 x 30 m	černá	6
41151	1,5 x 30 m	černá	6





## OKENNÍ ŠÍŤ SE SUCHÝM ZIPEM - BÍLÁ



Č.p.	specifikace		
40050	150 x 130 cm	5,6 m	10
40052	150 x 180 cm	6,6 m	10
40054	150 x 90 cm	4,8 m	10
40056	220 x 75 cm 2 ks	5,8 m	10



## OKENNÍ ŠÍŤ SE SUCHÝM ZIPEM - ŠEDÁ



Č.p.	specifikace		
40051	150 x 130 cm	5,6 m	10
40053	150 x 180 cm	6,6 m	10
40055	150 x 90 cm	4,8 m	10



## OKENNÍ ŠÍŤ SE SUCHÝM ZIPEM - ČERNÁ



Č.p.	specifikace		
40057	150 x 130 cm	5,6 m	10
40058	150 x 180 cm	6,6 m	10
40059	150 x 90 cm	4,8 m	10



## SUCHÝ ZIP SAMOLEPÍCÍ PRO OKENNÍ ŠÍŤ

Č.p.	specifikace	
40060	9 mm   7 m	1

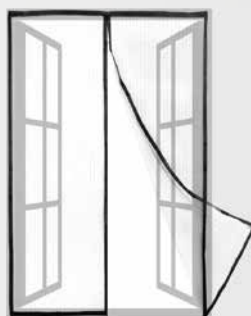

## DVEŘNÍ ZÁVĚS PROTI HMYZU MAGNETICKÝ - ANTRACIT



Č.p.	specifikace	
40077	100 x 220 cm	1



## DVEŘNÍ ZÁVĚS PROTI HMYZU

· variabilní rozměr 60 - 120 cm

Č.p.	specifikace		
40075	4 x 35 x 220 cm	bílá	20
40076	4 x 35 x 220 cm	černá	20

## PLETIVO HEX

· zinkováno před spletním

Zn

Č.p.	specifikace	
42150	13   0,7 x 1000 mm - 50 m	1
42151	16   0,7 x 1000 mm - 50 m	1
42152	20   0,7 x 1000 mm - 50 m	1
42153	25   0,8 x 1000 mm - 50 m	1



## PLETIVO HEX

Zn

Č.p.	specifikace	
42155	13   0,7 x 1000 mm - 50 m	1
42156	16   0,7 x 1000 mm - 50 m	1
42157	20   0,7 x 1000 mm - 50 m	1
42158	25   0,8 x 1000 mm - 50 m	1



## PLETIVO HEX POPLASTOVANÉ

Zn

Č.p.	specifikace	
42160	13   1 x 1000 mm - 25 m	1
42161	16   1 x 1000 mm - 25 m	1
42162	20   1 x 1000 mm - 25 m	1
42163	25   1 x 1000 mm - 25 m	1

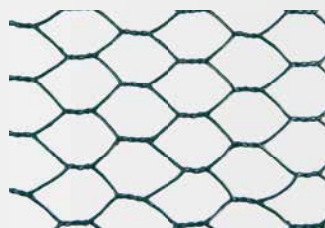

## OKRASNÉ PLETIVO POPLASTOVANÉ

Č.p.	velikost oka	Ø drátu	výška	length	
42175	15 x 9 mm	2 mm	40 cm	25 m	1
42176	15 x 9 mm	2 mm	65 cm	25 m	1
42177	15 x 9 mm	2 mm	90 cm	25 m	1
42178	15 x 9 mm	2 mm	120 cm	25 m	1
42179	15 x 9 mm	2 mm	25 cm	25 m	1





## PLETIVO ČTVEREC

140  
g/m<sup>2</sup>

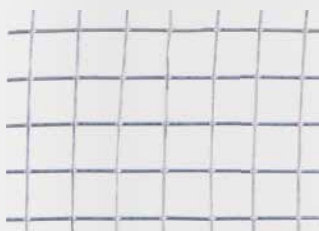

Č.p.	specifikace	Č.p.	specifikace
42185	6   0,65 x 1000 mm - 25 m	42174	25   1,4 x 1000 mm - 25 m
42170	10   0,8 x 100 mm - 25 m	42186	13   1,05 x 1000 mm - 25 m
42171	13   0,8 x 1000 mm - 25 m	42187	25   2,0 x 1000 mm - 25 m
42172	16   1,2 x 1000 mm - 25 m	42188	50   2,0 x 1000 mm - 25 m
42173	19   1,4 x 1000 mm - 25 m		

## PLETIVO ČTVEREC POPLASTOVANÉ

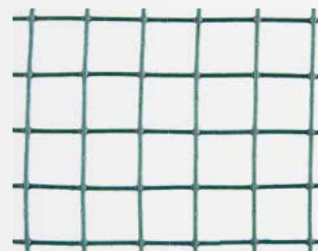

Č.p.	specifikace	
42180	13   1,2 x 1000 mm - 25 m	1
42181	16   1,2 x 1000 mm - 25 m	1
42182	25   2,3 x 1000 mm - 25 m	1

## SÍŤ PROTI PTÁKŮM

MADE IN  
EU



Č.p.	specifikace	
45570	2 x 5 m 18 x 18 mm	45
45571	2 x 10 m 18 x 18 mm	28
45572	4 x 5 m 18 x 18 mm	24
45573	4 x 10 m 18 x 18 mm	15

## BEZPEČNOSTNÍ SÍŤ

140  
g/m<sup>2</sup>

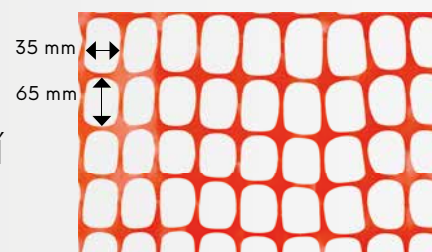

Č.p.	specifikace	
42190	1,2 x 50 m HDPE 140g/m <sup>2</sup>	1

## PLETIVO RABICOVÉ

Zn



Č.p.	specifikace	
42312	1 m   50 bm, 16 x 16 mm	1

## OCHRANA STROMŮ PROTI OKUSU

· samosvorná



Č.p.	specifikace	
45580	Ø 11 x 80 cm	1



## VÁZACÍ DRÁT

Zn

Č.p.	Ø drátu	délka drátu	
42203	0,6 mm	30 m	50



## VÁZACÍ DRÁT

Č.p.	Ø drátu	délka drátu	povrch	
42201	0,6 mm	30 m	PVC	50
42202	0,9 mm	30 m	PVC	50



## OSTNATÝ DRÁT

Zn

Č.p.	Ø drátu	délka drátu	
42260	1,7 mm	50 m	1
42261	1,7 mm	100 m	1



## NAPÍNACÍ ZAŘÍZENÍ

Č.p.	specifikace	
50035	2 t	6
50036	4 t	4



## PLOTOVÝ NAPÍNÁK MALÝ

Zn

Č.p.	specifikace	
50030	pozink malý	50
50032	PVC malý	50

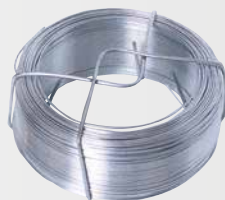

## VÁZACÍ DRÁT

Zn

Č.p.	Ø drátu	délka drátu	
42207	0,8 mm	50 m	40
42208	0,8 mm	100 m	20
42209	0,9 mm	100 m	20
42210	1,0 mm	100 m	20
42211	1,2 mm	50 m	40
42212	1,2 mm	100 m	20
42213	1,4 mm	30 m	40
42214	1,4 mm	50 m	20
42217	1,8 mm	30 m	40
42218	1,8 mm	50 m	20



## DRÁT VÁZACÍ

Č.p.	Ø drátu	délka drátu	
42244	1,4 mm	50 m	20
42248	1,8 mm	50 m	20
42249	2,0 mm	50 m	20



## SVORKA NAPÍNACÍHO DRÁTU

Č.p.	specifikace	MOQ	
50040	nerez hrot, zelená	50	50
50041	nerez hrot, černá	50	50



## PLOTOVÝ NAPÍNÁK VELKÝ

Zn

Č.p.	specifikace	
50031	pozink	50
50033	PVC	50



## NAPÍNACÍ DRÁT

Zn

Č.p.	Ø drátu	délka drátu	
42219	2,0 mm	26 m	20
42220	2,0 mm	52 m	20
42221	2,0 mm	78 m	20
42228	3,15 mm	26 m	10
42229	3,15 mm	52 m	10
42230	3,15 mm	78 m	10



## DRÁT NAPÍNACÍ

Č.p.	Ø drátu	délka drátu	
42251	2,6 mm	26 m	20
42252	2,6 mm	52 m	20
42253	2,6 mm	78 m	20
42255	3,4 mm	26 m	10
42256	3,4 mm	52 m	10
42257	3,4 mm	78 m	10



## SVORKA NAPÍNACÍHO DRÁTU

Č.p.	specifikace	MOQ	
50042		10	10



## PLOTOVÝ NAPÍNÁK MALÝ LT

Zn

Č.p.	specifikace	
50037	pozink	50
50038	PVC	50

## KOTEVNÍ PATKA SLOUPKU

Zn

Č.p.	specifikace	tl.	
55436	70 x 75 mm	110 mm	4 mm 10
55437	80 x 90 mm	130 mm	4 mm 10



## KOTEVNÍ PATKA SLOUPKU

Zn

Č.p.	specifikace	tl.	
55429	70 x 60 mm	100 mm	4 mm 10
55433	81 x 60 mm	100 mm	4 mm 10
55430	91 x 60 mm	100 mm	4 mm 10
55431	101 x 60 mm	100 mm	4 mm 10
55432	121 x 60 mm	100 mm	4 mm 10



## KOTEVNÍ PATKA SLOUPKU STAVITELNÁ

Zn

Č.p.	specifikace	tl.	
55465	80 - 160 x 70 mm	100 mm	4 mm 1

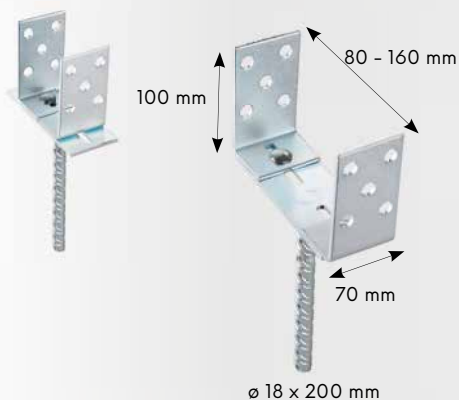

## KOTEVNÍ PATKA SLOUPKU

Zn

Č.p.	Ø patky	délka patky	tloušťka materiálu	
55420	71 x 71 mm	150 mm	2 mm	1
55425	81 x 81 mm	150 mm	2 mm	1
55421	91 x 91 mm	150 mm	2 mm	1
55422	101 x 101 mm	150 mm	2 mm	1
55423	121 x 121 mm	150 mm	2 mm	1
55424	151 x 151 mm	150 mm	2 mm	1



## PŮDNÍ VRTÁK

Č.p.	Ø	A	B	
61299	110 mm	270 mm	1200 mm	1
61300	140 mm	270 mm	1200 mm	1
61301	170 mm	270 mm	1200 mm	1
61302	200 mm	270 mm	1200 mm	1



## ZEMNÍ VRUT "U,"

Zn

Č.p.	Ø patky	délka patky	tloušťka materiálu	
55455	71 x 60 mm	100 mm	4 mm	1
55452	81 x 60 mm	100 mm	4 mm	1
55456	90 x 60 mm	100 mm	4 mm	1
55453	101 x 60 mm	100 mm	4 mm	1
55457	110 x 60 mm	100 mm	4 mm	1
55454	121 x 60 mm	100 mm	4 mm	1

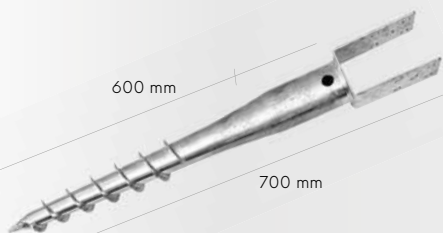

## PATKA SLOUPKU S NASTAVITELNÝM ŠROUBEM

Zn

Č.p.	Ø patky	výška patky	závit	
55460	80 x 80 mm	150 mm	M16	10
55461	100 x 100 mm	150 mm	M16	10
55462	150 x 150 mm	150 mm	M24	10



## KOTEVNÍ PATKA SLOUPKU

Zn

Č.p.	Ø patky	délka patky	tloušťka materiálu	
55400	71 x 71 mm	750 mm	2 mm	1
55401	91 x 91 mm	750 mm	2 mm	1
55406	81 x 81 mm	750 mm	2 mm	1
55402	91 x 91 mm	900 mm	2 mm	1
55403	101 x 101 mm	900 mm	2 mm	1
55404	121 x 121 mm	900 mm	2 mm	1
55405	151 x 151 mm	900 mm	2 mm	1



## ZEMNÍ VRUT

redukce

Ø 24 mm  
Ø 35 mm  
Ø 40 mm  
Ø 48 mm  
Ø 55 mm

Zn 6x

Č.p.	Ø patky	délka patky	specifikace	
55450	60 mm	550 mm	1 ks + 5x redukce	8



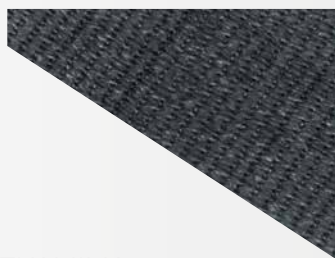

## STÍNÍCÍ TKANINA HDPE 150 g/m<sup>2</sup> ANTRACIT

· stínění 85%

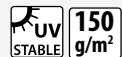

Č.p.	specifikace	
45496	1 x 10 m	1
45497	1,5 x 10 m	1
45498	1,8 x 10 m	1
45499	2 x 10 m	1

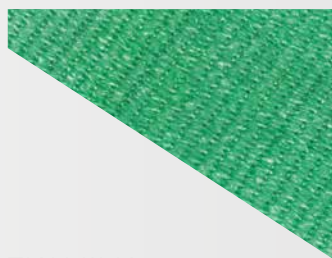

## STÍNÍCÍ TKANINA HDPE 150 g/m<sup>2</sup>

· stínění 85%



Č.p.	specifikace	
45460	1 x 10 m	1
45461	1,5 x 10 m	1
45463	1,8 x 10 m	1
45462	2 x 10 m	1



## STÍNÍCÍ TKANINA HDPE 220 g/m<sup>2</sup>

· stínění 95%



Č.p.	specifikace	
45465	1 x 10 m	1
45466	1,5 x 10 m	1
45467	2 x 10 m	1

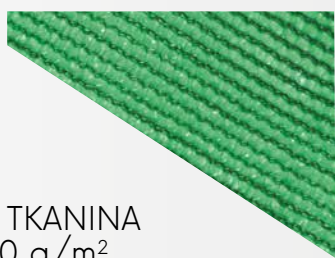

## STÍNÍCÍ TKANINA HDPE 80 g/m<sup>2</sup>



Č.p.	specifikace	
45450	1 x 10 m	1
45451	1,5 x 10 m	1
45453	1,8 x 10 m	1
45452	2 x 10 m	1

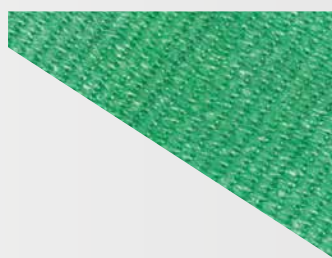

## STÍNÍCÍ TKANINA HDPE 150 g/m<sup>2</sup>

· stínění 85%



Č.p.	specifikace	
45480	1,5 x 50 m	1



## STÍNÍCÍ TKANINA HDPE 220 g/m<sup>2</sup>

· stínění 95%

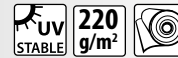

Č.p.	specifikace	
45485	1,5 x 50 m	1



## PÁSKY VÁZACÍ ZELENÉ

· EN 50146  
· nylon

50x

Č.p.	specifikace	
23875	120 mm 4,8 mm	1



## UPÍNKA STÍNÍCÍ TKANINY

20x

Č.p.	specifikace	
45470		1





## SADA GRILOVACÍHO NÁŘADÍ

INOX 18x

Č.p. specifikace  
43077

6



## SADA GRILOVACÍHO NÁŘADÍ

INOX 3x

Č.p. specifikace  
43071 380 mm

16



## GRILOVACÍ KLEŠTĚ

INOX

Č.p. specifikace  
43072 360 mm

25



## GRILOVACÍ TÁCEK

4x

Č.p. specifikace  
43050 300 x 200 mm

50



## OPĚKACÍ MŘÍŽKA

Č.p. specifikace  
43084 330 x 290 mm

50

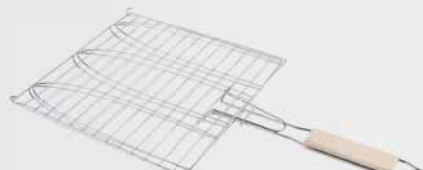

## OPĚKAČ RYB

Č.p. specifikace  
43082 280 x 276 mm

50

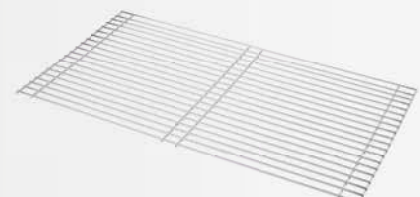

## GRILOVACÍ ROŠT

Č.p. specifikace  
43058 58 x 30 mm  
43060 60 x 40 mm  
43068 68 x 40 mm

20

20

16

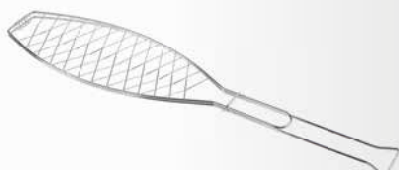

## OPĚKAČ RYB

Č.p. specifikace  
43083 360 x 130 mm

12



## ŠAŠLIKOVÉ JEHlice

4x

Č.p. specifikace  
43086 Ø 3 x 380 mm

80



## GRILOVACÍ VIDLICE

• grilovací vidlice s hygienickým atestem

Č.p. specifikace  
43097 100 cm

100

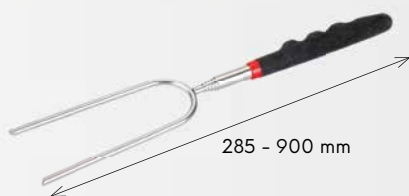

GRILOVACÍ VIDLICE - TELESKOPICKÁ

INOX



Č.p. specifikace  
43094

1



MECHANICKÉ DMYCHADLO



Č.p. specifikace  
43087

1



KARTÁČ NA ČIŠTĚNÍ 2 V 1

Č.p. specifikace  
43098 30 cm

10



KARTÁČ 3 V 1

Č.p. specifikace  
43099

40



GRILOVACÍ MOTOR 230V

CE



Č.p. specifikace  
43090

24



GRILOVACÍ MOTOREK BATERIOVÝ

baterie typ D



Č.p. specifikace  
43089

48



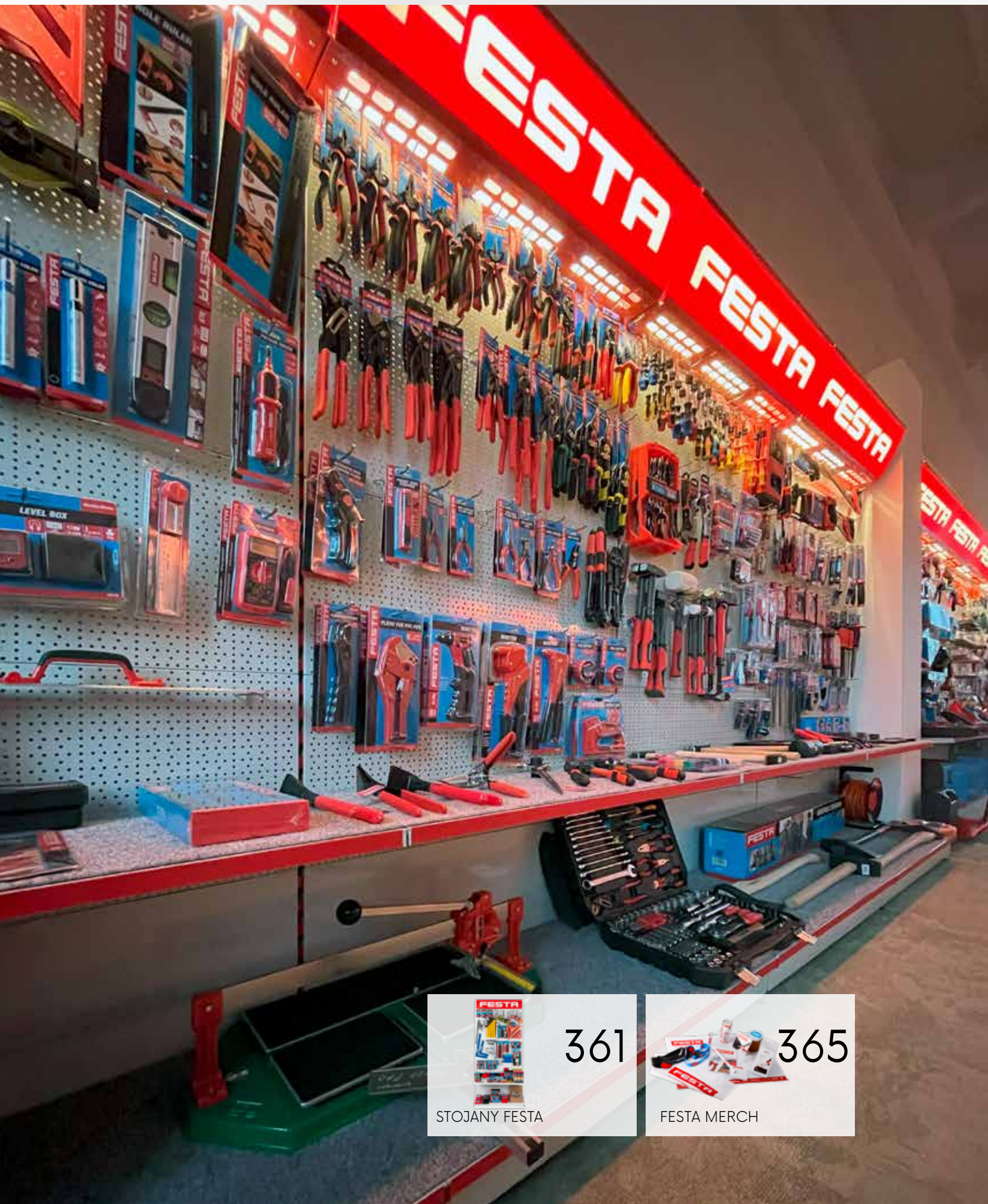

361

STOJANY FESTA



365

FESTA MERCH



## STOJAN FESTA OSAZENÝ

### FESTA

#### SVĚTELNÝ BOX PRO STOJAN FESTA 81011

Č.p.	specifikace	
81195	FESTA POWER TOOLS	1
81196	FESTA	1
81197	FESTA INDUSTRY	1



## STOJAN FESTA + PŘÍSLUŠENSTVÍ



Č.p.	specifikace	
81011	stojan FESTA 220 x 100 cm	1
81011A	stojan 81011 + samolepka AQUATIC	1
81011F	stojan 81011 + samolepka FESTA CZ	1
81011G	stojan 81011 + samolepka FESTA GB	1
81011H	stojan 81011 + samolepka FESTA SK	1
81011R	stojan 81011 + samolepka ROSA	1
81012	police FESTA 100 x 40 cm	8
81013	háček 10 cm	10
81014	háček 16 cm	10
81015	háček 20 cm	10
81035	háček s visačkou 20 cm	10
81016	háček 30 cm	10
81036	háček s visačkou 30 cm	10
81022	koš na hladítka - velký, 50 cm	1
81023	koš na hladítka - malý, 40 cm	1
81024	příčka ke koši - velká, 50 cm	1
81025	příčka ke koši - malá, 40 cm	1

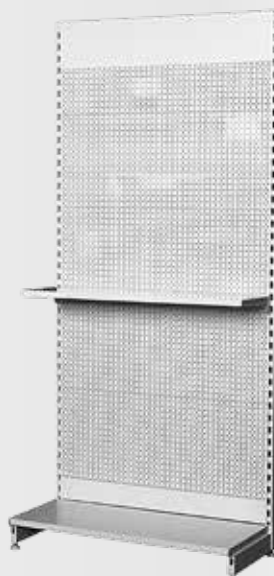

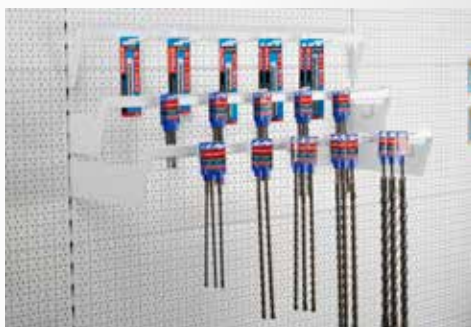

## TRADE KONZOLA

kompatibilní se stojanem FESTA

Č.p.	specifikace	
81150	1000 × 50 × 135 mm	1
81151	1000 × 150 × 135 mm	1
81152	1000 × 350 × 135 mm	1

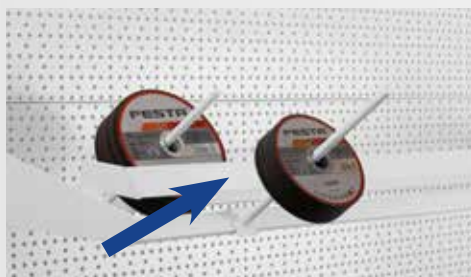

## DRŽÁK CENOVKOVÉ LIŠTY

kompatibilní se stojanem FESTA

Č.p.	specifikace	
81155	1000 × 80 × 100 mm	1

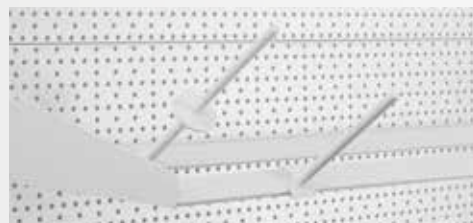

## HÁK PRO ŘEZNÉ KOTOUČE

kompatibilní se stojanem FESTA

Č.p.	specifikace	
81186	150 mm	1
81185	250 mm	1



## RÁM PRO ŘEZNÉ KOTOUČE

kompatibilní se stojanem FESTA

Č.p.	specifikace	
81170	1000 × 450 × 85 mm	1



## DRŽÁK NA PILY

kompatibilní se stojanem FESTA

Č.p.	specifikace	
81190		1



## HÁK PRO AKU NÁŘADÍ

kompatibilní se stojanem FESTA

Č.p.	specifikace	
81189		1



## POLICE PRO KOTOUČE

kompatibilní se stojanem FESTA

Č.p.	specifikace	
81191	220 × 220 × 200 mm	1

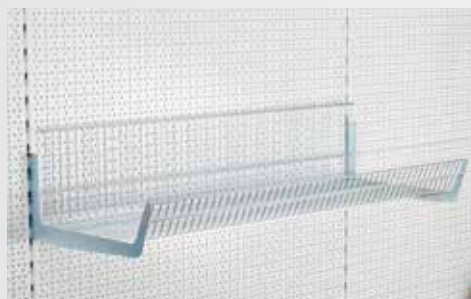

## KOŠ ZÁVĚSNÝ

kompatibilní se stojanem FESTA

Č.p.	specifikace	
81160	1000 × 470 × 180 mm	1



## DĚLÍTKO

kompatibilní se stojanem FESTA

Č.p.	specifikace	
81165	470 × 180 mm	1



## DRŽÁK NA KLADIVA A PALICE

Zn

kompatibilní se stojanem FESTA

Č.p.	specifikace	
81188	max 2 kg	1



## HÁK DVOJITÝ NA HRAZDU

kompatibilní se stojanem FESTA

Č.p.	specifikace	
81175	120 mm	1
81178	180 mm	1



## HÁK JEDNODUCHÝ NA HRAZDU

kompatibilní se stojanem FESTA

Č.p.	specifikace	
81180	120 mm	1



Č.p.	specifikace	
81200	Stojina 40/2400 mm kotvená	1
81201	Stojina 80/1108 mm	1
81202	Stojina 80/1208 mm	1
81203	Stojina 80/1408 mm	1
81204	Stojina 80/1608 mm	1
81205	Stojina 80/1808 mm	1
81206	Stojina 80/2000 mm	1
81207	Stojina 80/2108 mm	1
81208	Stojina 80/2208 mm	1
81209	Stojina 80/2308 mm	1
81210	Stojina 80/2408 mm	1
81211	Stojina 80/2600 mm	1
81212	Stojina 60/1000 mm	1
81213	Stojina 60/1208 mm	1
81214	Stojina 60/1408 mm	1
81215	Stojina 60/1608 mm	1
81216	Stojina 60/1808 mm	1
81217	Stojina 60/2108 mm	1
81218	Stojina 60/2208 mm	1
81225	Stojina 30/2108 mm přední	1
81486	Stojina 60/2000 mm	1
81219	Nástavec stojiny 80x30/100mm	1
81220	Nástavec stojiny 80x30/400 mm	1
81221	Nástavec stojiny 80x30/600 mm	1
81222	Nástavec stojiny 60x30/400 mm	1
81223	Stojina rohová 90st. 2100mm	1
81224	Stojina rohová 90st. 2200mm	1
81226	Podpěra 80	1
81227	Podpěra 60	1
81228	Spojka gondoly s regálem 80	1
81229	Kotevní lišta	1
81230	Kotevní hák	1
81231	Kotvení lehké	1
81232	Kotvení vrchní	1
81233	Výplň 400	1
81234	Výplň 500	1
81235	Výplň 600	1
81236	Výplň 700	1
81237	Výplň 800	1
81238	Konzola nízká 200	1
81239	Konzola nízká 300	1
81240	Konzola nízká 400	1
81241	Konzola nízká 500	1
81242	Konzola vysoká 400	1
81243	Konzola vysoká 500	1
81244	Konzola vysoká 600	1
81245	Konzola vysoká 700	1
81246	Konzola nízká 300 dvojitá	1
81247	Konzola nízká 400 dvojitá	1
81248	Konzola nízká 300 dvojitá	1
81251	Konzola RR 80	1
81249	Konzola vysoká dvojitá 500	1
81250	Nosník vys. vitríny 400/2000	1
81252	Dělitko korytově police	1
81253	Dělitko nízké 300	1
81254	Dělitko nízké 400	1
81255	Dělitko nízké 500	1
81256	Dělitko nízké 300 sklo	1
81257	Dělitko nízké 400 sklo	1
81258	Dělitko nízké 500 sklo	1
81259	Dělitko vysoké 300 sklo	1
81262	Dělitko vysoké 300 plexi	1
81263	Dělitko vysoké 400 plexi	1
81264	Dělitko vysoké 500 plexi	1
81260	Dělitko vysoké 400 sklo	1
81261	Dělitko vysoké 500 sklo	1
81265	Bok vys. vitríny 400/2000	1
81266	Bočnice zastřešení RR 80	1
81267	Bočnice zásobníku 500mm	1
81268	Bočnice vitríny 500	1
81269	Nosník horní vitríny 500	1
81271	Bočnice police nízká 300 plast	1
81272	Bočnice police nízká 400 plast	1
81273	Bočnice police nízká 500 plast	1
81274	Bočnice vysoká sklo 300/250	1
81275	Pojistka bočnice	1
81276	Bočnice vysoká sklo 500/250	1
81277	Bočnice police vysoká 400	1
81278	Bočnice police vysoká 500	1
81270	Nosník zastřešení RR 80	1
81279	Nosník zastřešení	1
81280	Bočnice zastřešení levá	1
81281	Bočnice zastřešení pravá	1
81282	Závěsově rameno	1
81284	Rameno dvojitě 400/10	1
81285	Rameno dvojitě 300/8	1
81286	Rameno jednoduché 350	1
81287	Rameno jednoduché 500	1
81288	Rameno jednoduché 250	1
81289	Závěs dvojitý 100	1
81290	Závěs dvojitý 200	1
81291	Závěs dvojitý 300	1
81292	Závěs 130 V	1

Č.p.	specifikace	
81293	Závěs jednoduchý 100	1
81294	Závěs jednoduchý 200	1
81295	Závěs jednoduchý 300	1
81296	Jednoháček s hrazdou 200	1
81297	Jednoháček s hrazdou 300	1
81298	Zámek vitríny	1
81299	Dělitko drátěné 360mm vysoké	1
81300	Dělitko drátěné 460 mm vysoké	1
81301	Dělitko drátěné 560 mm vysoké	1
81302	Dělitko drátěné 560 mm nízké	1
81303	Konzola 300 dvojitá L	1
81304	Konzola 300 dvojitá P	1
81305	Konzola 400 dvojitá L	1
81306	Konzola 400 dvojitá P	1
81307	Konzola 500 dvojitá L	1
81308	Konzola 500 dvojitá P	1
81309	Police půlkruh 300	1
81310	Police půlkruh 400	1
81311	Police půlkruh 500	1
81312	Šokl půlkruhu 500	1
81313	Čelo soklu půlkruhu 500	1
81314	Držák cenovky pol. 300 půlkruh	1
81315	Držák cenovky pol. 400 půlkruh	1
81316	Držák cenovky pol. 500 půlkruh	1
81317	Police půlkruh 600	1
81318	Šokl půlkruhu 600	1
81319	Čelo soklu půlkruhu 600	1
81320	Cenovka P 7,5x5 cm	1
81321	Cenovka P 2,6x3,2 cm	1
81322	Cenovka P 5,0x4,0 cm	1
81323	Police děrovaná 500/1000	1
81324	Spojnice stojin 80, modul 1	1
81325	Zadní panel 10x100cm	1
81326	Zadní panel 20x100cm	1
81327	Zadní panel 40x100cm	1
81328	Zadní panel dř. 20x100 cm EUR	1
81329	Zadní panel dř. 40x100 cm EUR	1
81330	Kryt gondol 8x100cm	1
81331	Kryt gondol 6x100cm	1
81332	Nosník závěsů 100cm	1
81333	Police skleněná 985/300 vitrína	1
81334	Police skleněná 985/400 vitrína	1
81335	Police dřevěná 47/98,5	1
81336	Police drátěná 1000/500	1
81337	Police korytová 1000x500	1
81338	Police 200/1000	1
81339	Police 300/1000	1
81340	Police 400/1000	1
81341	Police 500/1000	1
81342	Police 400/1000 RAL7015	1
81343	Police 500/1000 RAL7015	1
81347	Rám vysoké vitríny 1000/400	1
81348	Sklo rámu vysoké vitríny 1000/400	1
81349	Zásuvková vložka regalová	1
81350	Podhled kovové police 500/100	1
81352	Čelní opěra vysoká 1000 mm, sklo	1
81353	Čelní opěra vysoká, plexi	1
81354	Čelní opěra nízká 1000 mm, plast	1
81355	Cenovková lišta, 1000mm	1
81356	Hřeben zásuvky regálu	1
81351	Hřeben pro vysoká dělitka, 1000	1
81357	Hřeben, 1000 mm	1
81403	Hřeben pro vysoká dělitka, 1250 mm	1
81420	Hřeben pro vysoká dělitka, 625 mm	1
81358	Dvoudrážky dvířek vitríny	1
81359	Držák cenovky, 1000mm	1
81360	Dveře vys. vitríny 1000/2000	1
81361	Čelo zastřešení, 1000mm	1
81362	Deska zastřešení, 1000mm	1
81363	Dvířka zásobníku	1
81364	Dvířka vitríny posuvná	1
81365	Zrcadlo vitríny	1
81366	Závěsový rám, modul 1	1
81367	Závěsová tyč	1
81370	Koš drátěný šikmý	1
81371	Pult s plnou deskou 1000mm	1
81372	Sokl pultu SU 5 1000mm	1
81373	Pult prosklený 1000mm	1
81374	Pult s nerez deskou 1000mm	1
81375	Pult s plnou deskou 600mm	1
81376	Police do pultu 600mm	1
81377	Pult prosklený 600mm	1
81378	Police do pultu 1000mm	1
81379	Polička pultu dlouhá	1
81380	Segment pultu vysoký 90st.	1
81381	Dvoudrážka pultu 1000mm, pár	1
81382	Dvířka posuvná, pult 1000mm, pár	1
81383	Zásuvka pod desku	1
81384	Police drátěná RDE 1000/360mm	1
81385	Police drátěná RDE 1000/460mm	1
81386	Police drátěná RDE 1000/560mm	1
81387	Cenovková lišta RDE 1000 mm	1
81388	Zadní panel 100/1250mm plný	1

Č.p.	specifikace	
81389	Zadní panel 200/1250mm plný	1
81390	Zadní panel 400/1250mm plný	1
81391	Zadní panel 200/1250mm děrovaný	1
81393	Kryt gondoly 80/1250mm	1
81392	Zadní panel 400/1250mm děrovaný	1
81394	Kryt gondoly 60/1250mm	1
81395	Nosník závěsů 1250mm	1
81396	Police 200/1250mm	1
81439	Nosník závěsů 1000 mm	1
81344	Police 300/1000 zesílená	1
81345	Police 400/1000 zesílená	1
81346	Police 500/1000 zesílená	1
81397	Police 300/1250mm	1
81400	Police 300/1250mm, zesílená	1
81401	Police 400/1250mm, zesílená	1
81402	Police 500/1250mm, zesílená	1
81398	Police 400/1250mm	1
81399	Police 500/1250mm	1
81404	Čelní opěra nízká 1250mm, plast bílý	1
81405	Cenovková lišta, 1250mm	1
81406	Hřeben 1250mm	1
81407	Držák cenovky, 1250mm	1
81408	Čelo zastřešení, 1250mm	1
81409	Deska zastřešení, 600x1250mm	1
81410	Zadní panel 100/625 plný	1
81411	Zadní panel 200/625 plný	1
81412	Zadní panel 400/625 plný	1
81413	Zadní panel 400/625 děrovaný	1
81414	Kryt gondol 80/650	1
81415	Kryt gondol 60/650	1
81416	Nosník závěsů, modul 3	1
81432	Nosník závěsů, 1330mm	1
81417	Police 300/625	1
81418	Police 400/625	1
81419	Police 500/625	1
81421	Čelní opěra nízká 625, plast bílý	1
81422	Cenovková lišta 625mm	1
81423	Hřeben 625mm	1
81424	Držák cenovky, 625mm	1
81425	Zadní panel 100/1330 plný	1
81457	Čelní opěra nízká 200 plast	1
81426	Zadní panel 200/1330 plný	1
81427	Zadní panel 400/1330 plný	1
81428	Zadní panel 200/1330 děrovaný S	1
81429	Zadní panel 400/1330 děrovaný S	1
81430	Kryt gondol 80/1330	1
81431	Kryt gondol 60/1330	1
81433	Police 300/1330	1
81434	Police 400/1330	1
81435	Police 500/1330	1
81436	Cenovková lišta, 1330 mm	1
81437	Hřeben 1330 mm	1
81438	Držák cenovky 1330 mm	1
81440	Police drátěná - koš	1
81441	Zadní panel 100 koutový	1
81442	Zadní panel 400 koutový	1
81443	Čelo soklu koutové 500/1000mm	1
81444	Čelo soklu koutové 600 mm	1
81445	Zadní panel koutový 400mm děrovaný	1
81447	Police 300 koutová	1
81448	Police 400 koutová	1
81449	Police 500 koutová	1
81450	Police 600 koutová	1
81451	Držák cenovky 300 koutový	1
81452	Držák cenovky 400 koutový	1
81453	Držák cenovky 500 koutový	1
81454	Lišta cenovková 300 koutová	1
81455	Lišta cenovková 400 koutová	1
81456	Lišta cenovková 500 koutová	1
81458	Police drátěná koš U 1000/400	1
81459	Police drátěná koš U 1000/500	1
81460	Rohové čelo soklu 90st.	1
81461	Panel zadní rohový 100, stojina 60	1
81462	Panel zadní rohový 200, stojina 60	1
81463	Panel zadní rohový 400, stojina 80	1
81466	Panel zadní rohový 100, stojina 80	1
81467	Panel zadní rohový 400, stojina 60	1
81468	Police rohová 90st. 400mm	1
81469	Police rohová 90st. 500mm	1
81470	Držák cenovky rohový 90st. 400mm	1
81471	Držák cenovky rohový 90st. 500mm	1
81472	Cenovková lišta rohová 90st. 400mm	1
81473	Cenovková lišta rohová 90st. 500mm	1



## KONZOLA BÍLÁ

MOQ  
2

Č.p.	specifikace	
81100	100 x 75 mm	24
81101	125 x 100 mm	24
81102	150 x 125 mm	24
81103	200 x 150 mm	24
81104	250 x 200 mm	24
81105	300 x 250 mm	24
81106	350 x 300 mm	24



## REGÁLOVÁ STOJKA JEDNODUCHÁ

Č.p.	specifikace	
81053	50 cm	10
81054	80 cm	10
81057	200 cm	10



## REGÁLOVÝ HÁK JEDNODUCHÝ

Č.p.	specifikace	
81070	10 cm	10
81071	15 cm	10
81077	50 cm	10



## PAPÍROVÝ PREZentační STOJAN NA NIVELAČNÍ SYSTÉMY



Č.p.	specifikace	
37129	60 x 40 x 175 cm - CZ	1
37123	60 x 40 x 175 cm - osazený	1
37124	60 x 40 x 175 cm - osazený	1



## PAPÍROVÝ PREZentační STOJAN FESTA



Č.p.	specifikace	
81600	60 x 40 x 175 cm - CZ	1

## PAPÍROVÝ PREZentační STOJAN FESTA POWER TOOLS



Č.p.	specifikace	
81603	60 x 40 x 175 cm	1



**FESTA**

REKLAMNÍ BLOK FESTA

Č.p. specifikace  
M90400



**FESTA**

REKLAMNÍ TRIČKO FESTA ČERVENÉ

Č.p.	specifikace	
M90203	M	1
M90204	L	1
M90205	XL	1
M90206	XXL	1
M90207	XXXL	1



**FESTA**

REKLAMNÍ PROPISKA FESTA

Č.p. specifikace  
M90403



**FESTA**

REKLAMNÍ USB KABEL FESTA

Č.p. specifikace  
M90519



**FESTA**

REKLAMNÍ PONOŽKY FESTA

Č.p.	specifikace	
M90220	39-41	1
M90221	42-44	1
M90222	45-47	1



**FESTA**

REKLAMNÍ PŘÍVĚŠEK FESTA

Č.p. specifikace  
11410 2 m x 16 mm



**FESTA**

REKLAMNÍ KŠILTOVKA FESTA

Č.p.	specifikace	
M90210		1



**FESTA**

REKLAMNÍ ZAVÍRACÍ NŮŽ FESTA

Č.p.	specifikace	
16209		1



číslo položky	str.	číslo položky	str.	číslo položky	str.	číslo položky	str.	číslo položky	str.	číslo položky	str.
10002	96	11355	98	13249	121	13414	101	13509	99	14420	104
10003	96	11356	98	13250	121	13415	101	13510	99	14421	104
10005	96	11358	98	13251	121	13416	101	13511	99	14425	105
10008	96	11360	98	13252	121	13417	101	13512	99	14430	105
10025	96	11410	100	13253	121	13418	101	13513	99	14435	105
10033	96	11410	365	13254	121	13419	101	13514	99	14440	105
10035	96	11416	99	13255	121	13420	101	13515	99	14445	105
10043	96	11420	100	13256	121	13421	101	13516	99	14446	105
10045	96	11425	100	13257	121	13422	101	13517	99	14450	105
10048	96	11444	100	13258	121	13423	101	13518	99	14451	105
10110	96	11445	100	13259	121	13424	101	13519	99	14455	105
10120	96	12010	99	13260	120	13425	101	13520	99	14456	105
10130	96	12020	99	13261	117	13426	101	13521	99	14457	105
10330	96	12030	99	13262	117	13427	101	13522	99	14458	105
10332	96	12050	99	13263	117	13428	101	13523	99	14471	105
10334	96	12110	99	13264	116	13429	101	13524	99	14472	105
10336	96	12120	99	13265	116	13430	101	13525	99	14473	105
10430	97	12130	99	13266	116	13431	101	13526	99	14474	105
10450	97	12150	99	13267	117	13432	101	13527	99	14480	104
10490	97	12220	99	13268	116	13433	101	13528	99	14485	109
10996	97	12230	99	13269	116	13434	101	13529	99	14485	271
10998	97	12250	99	13270	116	13435	101	13530	99	14486	109
10999	97	12433	100	13271	116	13436	101	13531	99	14486	271
11002	99	12435	100	13272	116	13437	101	13532	99	14490	105
11003	99	13010	101	13273	116	13438	101	13533	99	14491	105
11005	99	13020	101	13274	116	13439	101	13534	99	14492	105
11006	99	13021	101	13275	116	13440	101	14001	102	14493	105
11007	99	13022	101	13276	117	13441	101	14002	102	14494	105
11008	99	13023	101	13277	120	13442	101	14003	102	15003	107
11082	99	13111	101	13278	116	13443	101	14004	102	15004	107
11083	99	13120	101	13279	117	13444	101	14006	102	15005	107
11085	99	13200	118	13280	117	13445	101	14007	102	15006	107
11102	98	13201	118	13281	102	13446	101	14008	102	15008	107
11103	98	13202	118	13282	102	13447	101	14009	102	15010	107
11105	98	13205	119	13284	117	13448	101	14010	103	15012	107
11106	98	13206	119	13285	102	13449	101	14011	103	15015	107
11107	98	13207	119	13288	117	13450	101	14012	103	15018	107
11110	98	13208	119	13290	217	13451	101	14013	102	15020	107
11200	99	13211	101	13293	217	13452	101	14015	103	15033	106
11201	99	13212	119	13294	217	13453	101	14017	103	15034	106
11202	99	13214	118	13295	120	13454	101	14019	103	15035	106
11204	99	13216	118	13296	120	13455	101	14025	105	15036	106
11205	99	13217	118	13350	121	13456	101	14030	103	15037	106
11206	99	13218	118	13351	121	13457	101	14035	102	15039	106
11207	99	13219	118	13352	121	13458	101	14040	102	15103	107
11208	99	13220	101	13353	121	13459	101	14045	102	15104	107
11209	99	13222	118	13354	121	13460	101	14060	103	15105	107
11210	99	13223	118	13355	121	13461	101	14070	103	15106	107
11220	98	13224	118	13360	121	13462	101	14075	103	15108	107
11221	98	13225	118	13361	121	13463	101	14077	103	15110	107
11226	98	13226	118	13362	121	13464	101	14080	102	15112	107
11239	98	13227	118	13363	121	13465	101	14090	104	15115	107
11259	98	13228	118	13364	121	13466	101	14091	104	15118	107
11260	98	13229	118	13365	121	13467	101	14220	105	15120	107
11311	100	13230	118	13399	101	13468	101	14225	105	15204	107
11312	100	13231	118	13400	101	13469	101	14230	105	15205	107
11313	100	13235	118	13401	101	13470	101	14235	105	15206	107
11314	100	13236	118	13402	101	13471	101	14240	105	15208	107
11323	98	13237	118	13403	101	13472	101	14250	105	15210	107
11325	98	13238	118	13404	101	13473	101	14350	105	15212	107
11327	98	13240	120	13405	101	13500	99	14360	105	15215	107
11333	98	13241	120	13406	101	13501	99	14370	105	15218	107
11335	98	13242	120	13407	101	13502	99	14380	105	15220	107
11337	98	13243	120	13408	101	13503	99	14399	105	15230	107
11338	98	13244	120	13409	101	13504	99	14410	105	15235	108
11343	98	13245	120	13410	101	13505	99	14411	105	15301	109
11345	98	13246	119	13411	101	13506	99	14415	104	15301	271
11347	98	13247	119	13412	101	13507	99	14417	104	15310	108
11353	98	13248	119	13413	101	13508	99	14418	104	15310	270

# REJSTRÍK POLOŽEK



číslo položky	str.	číslo položky	str.	číslo položky	str.	číslo položky	str.	číslo položky	str.	číslo položky	str.
15315	108	15810	109	16003	122	16075	130	16300	139	17037	137
15315	270	15810	271	16004	122	16077	130	16301	139	17038	177
15318	108	15812	109	16005	122	16078	130	16303	139	17039	176
15318	270	15812	271	16006	122	16081	130	16304	139	17040	174
15320	108	15815	109	16010	122	16082	129	16305	138	17041	174
15320	270	15815	271	16010	122	16083	131	16306	138	17042	174
15325	108	15818	109	16011	122	16084	131	16307	138	17043	174
15325	270	15818	271	16011	122	16085	126	16308	138	17044	174
15330	108	15820	109	16011	122	16086	126	16309	138	17045	174
15330	270	15820	271	16012	122	16087	127	16310	139	17046	177
15335	108	15825	109	16012	122	16090	125	16310	139	17047	172
15335	270	15825	271	16012	122	16091	125	16311	139	17048	177
15340	108	15830	109	16013	122	16095	127	16311	139	17049	177
15340	270	15830	271	16013	122	16099	124	16311	139	17050	139
15415	108	15850	109	16016	122	16100	124	16312	139	17050	181
15415	270	15850	271	16017	122	16105	124	16312	139	17051	177
15418	108	15853	109	16019	122	16110	124	16315	137	17052	177
15418	270	15853	271	16021	128	16115	124	16315	137	17053	177
15420	108	15855	109	16023	127	16120	124	16319	139	17054	177
15420	270	15855	271	16024	128	16125	124	16320	139	17055	177
15425	108	15860	109	16025	125	16130	126	16321	139	17056	177
15425	270	15860	271	16026	128	16131	124	16321	229	17057	177
15430	108	15870	109	16028	128	16135	126	16401	181	17058	177
15430	270	15870	271	16029	125	16136	125	16405	181	17059	176
15510	108	15880	109	16030	128	16137	125	16406	181	17060	176
15510	270	15880	271	16031	128	16140	126	16407	181	17061	176
15515	108	15885	256	16032	128	16141	128	16408	181	17062	176
15515	270	15886	256	16033	127	16142	125	16420	181	17063	175
15518	108	15886	349	16034	126	16143	125	16500	176	17064	175
15518	270	15887	256	16035	127	16144	125	16501	176	17065	175
15520	108	15887	349	16036	129	16145	125	16502	176	17066	175
15520	270	15888	256	16037	127	16146	125	16990	136	17067	175
15525	108	15888	349	16039	127	16147	126	16990	320	17068	175
15525	270	15889	256	16041	129	16150	125	16991	136	17069	175
15530	108	15893	109	16042	129	16151	125	16991	320	17070	175
15530	270	15893	271	16042	279	16198	131	16998	122	17071	175
15535	108	15894	109	16043	128	16199	131	16999	122	17072	175
15535	270	15894	271	16044	126	16201	132	17001	171	17075	175
15540	108	15895	109	16046	128	16202	173	17002	171	17076	175
15540	270	15895	271	16049	129	16205	173	17003	171	17077	175
15615	108	15904	111	16050	129	16206	173	17004	171	17078	177
15615	270	15906	111	16051	129	16208	173	17005	171	17079	176
15620	108	15908	111	16052	129	16209	133	17006	171	17080	176
15620	270	15910	111	16053	128	16209	365	17007	171	17081	176
15625	108	15912	111	16054	129	16210	132	17008	171	17082	176
15625	270	15915	111	16055	128	16211	132	17009	171	17083	178
15630	108	15920	111	16056	278	16212	132	17010	171	17084	176
15630	270	15954	111	16057	126	16218	133	17011	171	17085	176
15710	109	15956	111	16058	126	16219	133	17012	176	17086	176
15710	270	15958	111	16059	129	16220	133	17013	176	17087	172
15715	109	15960	111	16060	130	16221	133	17014	176	17089	178
15715	270	15962	111	16061	130	16222	133	17015	178	17090	178
15720	109	15965	111	16062	130	16223	133	17016	178	17091	178
15720	270	15970	111	16063	130	16224	134	17017	178	17092	178
15725	109	15980	111	16064	130	16225	132	17019	178	17093	178
15725	270	15981	111	16065	130	16226	134	17020	177	17094	171
15730	109	15983	100	16066	124	16227	134	17021	177	17095	171
15730	270	15985	100	16066	130	16228	134	17022	177	17096	171
15735	109	15988	100	16067	130	16229	132	17023	175	17097	171
15735	270	15989	100	16068	130	16230	132	17024	171	17098	171
15740	109	15990	111	16069	129	16231	132	17025	174	17099	171
15740	270	15991	111	16070	129	16231	135	17026	137	17100	171
15754	110	15992	111	16070	131	16232	134	17027	137	17101	169
15756	110	15993	111	16071	127	16232	174	17028	177	17102	169
15758	110	15996	110	16071	130	16234	132	17029	176	17103	169
15760	110	15997	110	16072	130	16235	133	17033	176	17104	169
15762	110	15998	110	16073	131	16236	133	17034	175	17105	169
15768	110	15999	110	16074	126	16281	127	17035	175	17108	171
15770	110	16002	122	16074	131	16282	127	17036	175	17109	175

číslo položky	str.	číslo položky	str.	číslo položky	str.	číslo položky	str.	číslo položky	str.	číslo položky	str.
17110	171	17238	156	17393	160	17528	165	17622	164	17831	159
17111	179	17240	158	17394	160	17532	166	17623	164	17832	159
17112	179	17241	158	17395	160	17533	166	17624	164	17835	159
17113	179	17242	158	17396	160	17534	166	17625	164	17836	159
17116	179	17243	158	17397	160	17539	165	17626	164	17837	159
17117	179	17244	158	17398	160	17548	164	17628	164	17838	159
17121	179	17245	155	17400	161	17549	164	17629	164	17839	159
17122	179	17247	153	17401	160	17550	164	17630	164	17840	159
17125	172	17250	161	17402	160	17551	164	17631	164	17841	159
17126	172	17255	161	17405	160	17552	164	17632	164	17842	159
17127	172	17259	153	17406	160	17553	164	17633	164	17843	159
17128	172	17260	153	17407	160	17554	164	17640	166	17844	159
17130	172	17261	167	17410	160	17555	164	17642	166	17845	159
17133	172	17262	167	17411	160	17556	164	17643	166	17846	159
17135	172	17292	158	17412	160	17557	164	17644	166	17847	159
17137	172	17294	158	17413	160	17558	164	17645	166	17848	159
17138	172	17295	158	17414	160	17559	164	17650	166	17849	159
17140	169	17296	158	17415	160	17560	164	17651	166	17850	159
17142	169	17297	158	17416	160	17561	164	17652	166	17851	159
17145	169	17298	158	17420	160	17562	164	17653	166	17852	159
17146	169	17299	158	17421	160	17563	164	17654	166	17853	159
17148	169	17300	178	17422	160	17564	164	17655	166	17854	159
17150	175	17301	178	17427	161	17565	164	17656	166	17855	159
17151	175	17302	178	17450	167	17566	164	17657	166	17856	159
17158	181	17303	178	17451	167	17567	164	17658	166	17860	159
17159	181	17304	178	17452	167	17568	164	17659	166	17861	159
17160	181	17305	178	17454	168	17569	164	17660	164	17862	159
17165	179	17306	178	17455	161	17570	164	17661	164	17863	159
17167	179	17308	159	17455	168	17571	164	17662	164	17864	159
17169	179	17309	159	17456	168	17572	164	17663	164	17865	159
17170	179	17310	159	17458	168	17573	164	17664	164	17866	159
17172	178	17311	159	17459	168	17574	164	17665	164	17867	159
17175	180	17312	159	17460	164	17575	164	17666	164	17868	159
17177	180	17313	159	17461	164	17576	164	17667	164	17869	159
17178	172	17314	159	17462	164	17577	164	17668	164	17870	159
17180	172	17315	159	17463	164	17578	164	17669	164	17871	159
17181	172	17316	159	17464	164	17579	164	17670	164	17872	159
17182	45	17317	159	17465	164	17580	164	17671	164	17873	159
17182	137	17318	159	17467	164	17581	164	17672	164	17874	159
17183	45	17319	159	17468	164	17582	164	17674	164	17875	159
17183	137	17320	159	17469	164	17583	164	17675	164	17876	159
17185	181	17321	159	17470	164	17584	164	17676	164	17877	159
17186	180	17322	159	17471	164	17585	164	17677	164	17878	159
17187	181	17324	159	17472	164	17586	164	17678	164	17879	159
17188	181	17327	159	17473	164	17587	164	17679	164	17880	159
17189	181	17330	159	17475	166	17589	164	17680	168	17881	159
17190	174	17332	159	17476	166	17590	164	17681	168	17882	159
17191	174	17333	159	17480	164	17591	164	17682	168	17883	159
17192	174	17334	159	17481	164	17592	164	17683	164	17884	159
17193	174	17338	167	17482	164	17593	164	17685	165	17885	159
17197	165	17341	178	17483	164	17600	167	17761	164	17886	159
17198	165	17342	178	17484	164	17601	167	17769	164	17887	159
17199	165	17350	162	17485	164	17603	167	17788	164	17888	159
17200	165	17351	162	17486	164	17605	164	17795	164	17889	159
17201	165	17352	162	17487	164	17606	164	17806	164	17890	159
17202	165	17353	162	17488	164	17607	164	17810	161	17891	159
17203	167	17357	162	17489	164	17608	164	17811	161	17892	159
17204	167	17359	162	17490	164	17609	164	17812	161	17895	159
17205	167	17361	162	17491	164	17610	164	17820	159	17896	159
17206	167	17380	161	17492	164	17611	164	17821	159	17897	159
17229	155	17381	161	17493	164	17612	164	17822	159	17898	159
17230	155	17382	160	17494	164	17613	164	17823	159	17904	159
17231	155	17383	160	17495	164	17614	164	17824	159	17905	159
17233	155	17384	160	17496	164	17615	164	17825	159	17907	159
17234	155	17385	160	17501	166	17616	164	17826	159	17910	159
17235	156	17386	160	17506	165	17617	164	17827	159	17914	159
17236	156	17390	160	17508	165	17619	165	17828	159	17916	159
17237	154	17391	160	17512	166	17620	166	17829	159	17922	159
17238	153	17392	160	17526	165	17621	166	17830	159	17924	159

číslo položky	str.	číslo položky	str.	číslo položky	str.	číslo položky	str.	číslo položky	str.	číslo položky	str.
17926	159	18302	143	18498	163	18638	147	18828	148	18971	160
17930	159	18303	143	18499	163	18639	147	18829	148	18993	150
17934	159	18304	143	18500	163	18640	147	18830	148	18994	150
17935	159	18310	140	18501	162	18641	147	18831	148	19001	197
17943	159	18311	140	18508	163	18645	147	18832	148	19002	197
17944	159	18312	140	18510	162	18646	147	18835	148	19003	197
17970	148	18313	140	18511	162	18680	147	18836	148	19004	197
17971	148	18321	140	18512	162	18685	147	18837	148	19005	197
17972	148	18322	140	18513	162	18710	146	18838	148	19006	197
17973	148	18340	141	18514	162	18711	146	18839	148	19008	197
17974	148	18350	140	18515	162	18712	146	18840	148	19010	197
17975	148	18351	140	18516	162	18715	146	18841	148	19015	197
17976	148	18352	140	18518	162	18716	146	18842	148	19020	197
17980	148	18353	140	18519	162	18717	146	18843	148	19021	195
17981	148	18354	140	18520	162	18720	146	18844	148	19022	195
17982	148	18355	140	18521	162	18721	146	18845	148	19023	195
17983	148	18356	140	18522	162	18722	146	18846	148	19024	195
18062	142	18357	140	18523	162	18723	146	18847	148	19025	195
18063	142	18358	140	18524	162	18724	146	18850	148	19026	195
18064	142	18359	140	18527	162	18725	146	18851	148	19028	195
18065	142	18360	140	18567	162	18750	147	18852	148	19030	195
18066	142	18400	143	18572	162	18751	147	18853	148	19031	195
18067	142	18401	143	18575	162	18753	147	18855	148	19032	195
18070	142	18402	141	18576	162	18755	147	18856	148	19034	195
18071	142	18403	141	18577	162	18760	147	18860	148	19036	195
18072	142	18404	141	18578	162	18761	147	18861	148	19041	195
18075	142	18408	145	18579	162	18762	147	18862	148	19042	195
18076	142	18409	145	18580	162	18763	147	18863	148	19043	195
18077	142	18410	142	18581	162	18764	147	18864	148	19044	195
18080	142	18411	142	18582	162	18765	147	18865	148	19045	195
18081	142	18413	142	18583	162	18766	147	18866	148	19046	195
18082	142	18415	144	18584	162	18767	147	18867	148	19050	197
18083	142	18416	144	18585	162	18768	147	18868	148	19051	197
18084	142	18417	144	18587	162	18769	147	18869	148	19052	197
18085	142	18418	143	18588	162	18770	147	18870	148	19053	197
18086	142	18419	144	18589	162	18771	147	18871	148	19054	197
18087	142	18420	144	18593	162	18772	147	18872	148	19055	197
18088	142	18421	152	18600	149	18775	147	18873	148	19056	197
18089	142	18422	141	18601	149	18776	147	18874	148	19057	197
18090	142	18423	142	18602	149	18777	147	18900	151	19058	195
18091	142	18424	141	18603	158	18795	149	18901	151	19059	195
18092	142	18425	140	18604	161	18796	149	18905	151	19060	196
18101	143	18426	145	18605	149	18797	149	18906	151	19061	196
18102	143	18427	145	18607	149	18798	149	18907	152	19062	196
18103	143	18428	115	18608	144	18799	149	18908	151	19063	196
18104	143	18429	115	18609	150	18800	148	18909	151	19064	196
18105	143	18430	152	18610	150	18801	148	18910	145	19065	196
18106	143	18431	144	18611	150	18802	148	18915	152	19066	195
18107	143	18432	146	18612	150	18803	148	18920	160	19067	195
18108	143	18433	144	18613	150	18804	148	18921	160	19068	195
18110	143	18434	140	18614	150	18805	148	18922	160	19069	195
18113	140	18435	145	18615	150	18806	148	18925	160	19070	195
18114	140	18437	145	18618	150	18807	148	18926	160	19071	195
18115	140	18440	152	18619	149	18810	148	18927	160	19074	195
18116	140	18445	173	18619	161	18811	148	18928	160	19075	195
18118	140	18450	143	18620	147	18812	148	18929	160	19076	195
18120	140	18451	143	18621	147	18813	148	18930	160	19077	195
18124	140	18455	143	18623	147	18814	148	18931	160	19081	195
18125	140	18456	143	18625	147	18815	148	18934	160	19082	195
18201	143	18460	143	18627	147	18816	148	18939	160	19083	195
18202	143	18476	162	18628	147	18817	148	18948	160	19084	195
18203	143	18490	163	18630	147	18820	148	18950	160	19085	195
18204	143	18491	163	18631	147	18821	148	18951	160	19086	195
18210	140	18492	163	18632	147	18822	148	18954	160	19088	195
18211	140	18493	163	18633	147	18823	148	18955	160	19090	195
18212	140	18494	162	18634	147	18824	148	18956	160	19092	195
18215	140	18495	162	18635	147	18825	148	18960	160	19095	195
18216	140	18496	163	18636	147	18826	148	18961	160	19096	195
18301	143	18497	163	18637	147	18827	148	18963	160	19097	195

číslo položky	str.	číslo položky	str.	číslo položky	str.	číslo položky	str.	číslo položky	str.	číslo položky	str.
19098	195	19394	317	19473	202	19580	56	19643	56	19704	57
19100	196	19395	317	19474	202	19585	56	19644	56	19705	57
19106	195	19396	317	19477	202	19585	56	19645	56	19705	57
19108	195	19397	317	19478	202	19586	56	19645	56	19706	57
19109	195	19398	197	19480	202	19587	56	19646	56	19707	57
19110	200	19399	197	19481	202	19588	56	19647	56	19708	57
19115	44	19400	201	19483	202	19589	56	19648	56	19708	57
19115	197	19400	251	19485	201	19590	56	19649	56	19709	57
19124	196	19401	201	19486	201	19590	56	19650	56	19710	57
19136	196	19401	251	19487	201	19591	56	19650	56	19711	57
19148	196	19402	201	19490	135	19593	56	19651	56	19711	57
19149	196	19402	251	19491	135	19594	56	19652	56	19712	57
19150	196	19403	201	19492	135	19595	56	19653	56	19713	57
19151	196	19403	251	19493	135	19595	56	19654	56	19713	57
19202	198	19404	201	19494	135	19596	56	19655	56	19714	57
19208	199	19404	251	19495	135	19597	56	19656	56	19715	57
19209	199	19405	201	19496	135	19598	56	19657	56	19716	57
19211	199	19405	251	19497	135	19599	56	19658	56	19717	57
19245	198	19406	201	19498	135	19600	56	19659	56	19718	57
19246	198	19406	251	19499	135	19600	56	19660	56	19718	57
19247	198	19407	201	19501	135	19601	56	19661	56	19719	57
19248	198	19407	251	19502	135	19603	56	19662	56	19720	57
19249	198	19408	201	19510	134	19604	56	19663	56	19721	57
19251	199	19408	251	19515	134	19605	56	19664	56	19722	57
19252	199	19409	201	19520	134	19605	56	19665	56	19723	57
19253	199	19409	251	19530	56	19606	56	19669	56	19723	57
19254	199	19410	201	19530	56	19607	56	19670	57	19724	57
19255	199	19411	201	19535	56	19608	56	19671	57	19725	57
19265	199	19412	201	19535	56	19609	56	19672	57	19726	57
19270	199	19415	200	19536	56	19610	56	19673	57	19727	57
19271	199	19416	200	19537	56	19610	56	19673	57	19728	57
19272	199	19418	201	19538	56	19611	56	19674	57	19728	57
19281	199	19419	201	19539	56	19612	56	19675	57	19729	57
19290	199	19420	200	19540	56	19613	56	19676	57	19730	57
19293	199	19421	200	19540	56	19614	56	19677	57	19731	57
19294	199	19422	200	19543	56	19615	56	19678	57	19732	57
19295	199	19423	200	19544	56	19615	56	19678	57	19733	57
19297	199	19424	200	19545	56	19616	56	19679	57	19733	57
19301	316	19425	200	19545	56	19617	56	19680	57	19734	57
19303	196	19426	200	19550	56	19618	56	19681	57	19735	57
19306	317	19427	200	19550	56	19619	56	19682	57	19736	57
19308	317	19429	201	19552	56	19620	56	19683	57	19737	57
19310	317	19430	197	19552	56	19620	56	19683	57	19738	57
19312	317	19431	197	19554	56	19621	56	19684	57	19738	57
19314	317	19432	197	19555	56	19622	56	19685	57	19739	57
19326	316	19433	197	19555	56	19623	56	19686	57	19740	57
19328	316	19434	197	19557	56	19624	56	19687	57	19741	57
19330	316	19435	197	19558	56	19625	56	19688	57	19742	57
19332	316	19436	201	19559	56	19625	56	19688	57	19743	57
19333	316	19440	197	19560	56	19626	56	19689	57	19743	57
19335	316	19441	197	19560	56	19627	56	19690	57	19744	57
19337	316	19442	197	19562	56	19628	56	19691	57	19745	57
19340	316	19443	197	19562	56	19629	56	19692	57	19746	57
19370	317	19450	135	19564	56	19630	56	19693	57	19747	57
19371	317	19451	135	19565	56	19630	56	19693	57	19748	57
19374	317	19455	135	19565	56	19631	56	19694	57	19748	57
19380	316	19457	135	19567	56	19632	56	19695	57	19749	57
19381	316	19458	135	19568	56	19633	56	19695	57	19750	57
19382	316	19459	135	19568	56	19634	56	19696	57	19751	57
19383	316	19460	201	19570	56	19635	56	19697	57	19752	57
19384	316	19460	251	19570	56	19635	56	19698	57	19753	57
19385	316	19462	317	19574	56	19636	56	19698	57	19753	57
19387	316	19463	317	19575	56	19637	56	19699	57	19754	57
19388	316	19464	317	19575	56	19638	56	19700	57	19755	57
19389	316	19465	317	19576	56	19639	56	19701	57	19756	57
19390	316	19469	317	19577	56	19640	56	19701	57	19757	57
19391	316	19470	201	19578	56	19640	56	19702	57	19758	57
19392	316	19470	251	19579	56	19641	56	19703	57	19758	57
19393	317	19472	202	19580	56	19642	56	19703	57	19759	57

číslo položky	str.	číslo položky	str.	číslo položky	str.	číslo položky	str.	číslo položky	str.	číslo položky	str.
19760	57	20300	59	20489	61	20751	67	20896	63	21110	75
19761	57	20305	59	20490	61	20752	67	20897	63	21111	75
19762	57	20310	59	20491	61	20753	67	20898	63	21112	75
19763	57	20311	59	20492	61	20754	67	20899	63	21115	75
19763	57	20315	60	20493	61	20755	67	20901	64	21118	75
19764	57	20316	59	20494	61	20756	67	20905	64	21123	75
19765	57	20317	59	20495	61	20757	67	20910	64	21130	75
19766	57	20320	60	20496	61	20758	67	20911	63	21135	75
19767	57	20321	60	20508	67	20759	67	20912	63	21140	75
19768	57	20333	58	20510	67	20760	67	20913	63	21150	75
19768	57	20334	58	20511	67	20761	67	20915	63	21180	75
19769	57	20335	58	20512	67	20762	67	20916	63	21190	75
19770	57	20336	58	20513	67	20764	67	20917	63	21192	77
19771	57	20337	58	20514	67	20765	67	20918	63	21194	77
19772	57	20338	58	20515	67	20766	67	20919	63	21195	75
19772	57	20340	60	20516	67	20767	67	20920	63	21200	74
19773	57	20350	202	20520	67	20768	67	20921	63	21201	74
19774	57	20360	139	20521	67	20769	67	20922	63	21203	74
19775	57	20361	139	20522	67	20770	67	20923	63	21204	74
19776	57	20363	180	20523	67	20771	67	20924	63	21205	74
19776	57	20364	180	20524	67	20772	67	20932	69	21209	74
19777	57	20365	29	20525	67	20773	67	20936	69	21210	75
19778	57	20379	29	20526	67	20774	67	20937	69	21211	75
19779	57	20380	60	20673	67	20775	67	20938	69	21212	75
19780	57	20381	64	20674	67	20776	67	20939	69	21215	75
19781	57	20385	62	20675	67	20777	67	20940	69	21218	75
19781	57	20386	62	20676	67	20778	67	20941	69	21219	75
19782	57	20387	62	20677	67	20779	67	20942	69	21220	75
19783	57	20390	62	20678	67	20780	67	20943	69	21223	75
19783	57	20391	62	20680	67	20781	67	20944	69	21224	75
19784	57	20394	62	20682	67	20782	67	20945	69	21230	74
19785	57	20395	62	20684	67	20783	67	20946	69	21231	74
19786	57	20396	62	20685	67	20784	67	20947	69	21234	74
19786	57	20397	62	20686	67	20785	67	20948	69	21235	74
19787	57	20400	58	20687	67	20786	67	20949	69	21238	74
19788	57	20401	58	20688	67	20787	67	20950	68	21301	75
19789	57	20402	58	20690	67	20788	67	20952	68	21303	75
19790	57	20403	58	20691	67	20789	67	20954	68	21306	77
19791	57	20404	58	20692	67	20790	67	20956	69	21308	77
19792	57	20405	58	20694	67	20791	67	20957	63	21311	75
19793	57	20406	58	20696	67	20792	67	20958	63	21312	75
19794	57	20407	58	20697	67	20793	67	20960	29	21315	75
19795	57	20408	58	20698	67	20794	67	20961	29	21318	75
19796	57	20409	58	20724	63	20795	67	20963	29	21323	75
19797	57	20410	58	20725	63	20796	67	20965	29	21324	75
19798	57	20411	58	20726	63	20797	67	20966	29	21326	75
19799	57	20412	58	20727	63	20798	67	20967	166	21327	75
19800	57	20413	58	20728	63	20799	67	20968	166	21411	75
19801	57	20414	58	20729	63	20805	68	20970	202	21412	75
19802	57	20415	58	20730	63	20820	68	20971	202	21415	75
19841	58	20416	58	20731	63	20825	67	20972	202	21418	75
19842	58	20417	58	20732	63	20855	67	20973	202	21423	75
19845	58	20418	58	20733	63	20861	67	20980	63	21424	75
19885	58	20419	58	20734	63	20862	67	20981	63	21425	76
19895	58	20420	58	20735	63	20870	67	20982	63	21426	76
20210	64	20421	58	20736	63	20871	67	20983	63	21427	76
20220	57	20422	58	20737	63	20872	67	20984	63	21428	76
20225	57	20423	58	20738	63	20873	67	20990	69	21430	76
20230	57	20424	58	20739	63	20874	67	20991	69	21431	76
20235	57	20425	58	20740	63	20875	67	20992	69	21432	76
20240	57	20426	58	20741	63	20876	67	20996	68	21435	76
20245	57	20427	58	20742	150	20877	67	20997	69	21436	76
20250	57	20428	58	20743	29	20878	67	20999	68	21437	76
20255	57	20429	58	20743	149	20879	67	21010	75	21440	64
20260	57	20430	58	20744	29	20880	67	21011	75	21441	64
20270	57	20450	64	20745	29	20881	67	21012	75	21442	64
20280	57	20460	64	20748	67	20890	68	21015	75	21443	64
20290	57	20487	61	20749	67	20891	68	21018	75	21444	64
20296	57	20488	61	20750	67	20895	68	21023	75	21445	64

číslo položky	str.	číslo položky	str.	číslo položky	str.	číslo položky	str.	číslo položky	str.	číslo položky	str.
21446	64	21803	78	22012	81	22083	82	22170	189	22277	76
21450	66	21804	78	22013	81	22084	82	22171	189	22280	76
21451	66	21805	78	22014	81	22085	82	22172	189	22281	76
21452	66	21806	78	22015	81	22086	187	22173	189	22285	76
21453	66	21807	65	22016	81	22087	83	22174	189	22286	76
21454	66	21807	78	22017	81	22088	82	22178	188	22294	76
21530	64	21808	65	22018	81	22090	82	22180	188	22300	86
21531	63	21808	78	22019	81	22091	83	22181	188	22301	86
21532	63	21809	79	22020	81	22092	83	22182	188	22302	86
21533	63	21810	84	22021	81	22093	83	22183	188	22303	86
21534	63	21811	84	22022	81	22095	82	22184	188	22305	86
21535	63	21812	84	22023	81	22096	84	22185	188	22307	86
21536	63	21813	84	22024	81	22097	84	22186	188	22309	86
21540	66	21814	84	22025	81	22098	84	22188	189	22310	86
21541	66	21831	84	22026	81	22099	84	22189	189	22311	86
21701	84	21832	84	22027	81	22100	85	22190	189	22312	86
21702	84	21834	84	22028	81	22101	85	22196	189	22313	86
21703	84	21850	85	22029	81	22102	85	22197	189	22314	86
21704	84	21851	85	22030	81	22103	85	22198	189	22315	86
21705	84	21852	85	22031	81	22104	85	22199	189	22316	86
21706	84	21853	85	22032	82	22105	85	22200	70	22317	86
21709	84	21854	85	22033	187	22106	85	22201	70	22318	86
21715	84	21855	85	22034	187	22107	85	22202	189	22319	86
21716	84	21856	85	22035	187	22108	85	22203	189	22320	86
21717	84	21857	85	22036	187	22109	85	22204	189	22322	86
21718	84	21858	85	22037	80	22110	85	22205	189	22324	86
21719	84	21859	85	22038	80	22111	85	22206	188	22326	86
21720	84	21860	85	22039	81	22112	85	22207	188	22328	86
21721	84	21861	85	22040	81	22113	85	22208	188	22329	86
21724	84	21862	85	22041	83	22115	85	22209	188	22332	86
21732	84	21863	85	22042	83	22116	85	22211	77	22333	86
21734	84	21864	85	22043	83	22117	85	22212	77	22335	86
21735	84	21900	80	22044	83	22119	85	22215	77	22337	86
21736	84	21901	80	22045	84	22120	293	22216	77	22340	86
21737	84	21902	80	22046	84	22121	293	22217	77	22343	86
21740	84	21903	80	22047	84	22122	293	22218	77	22345	86
21741	84	21904	80	22048	84	22123	293	22219	77	22350	86
21742	84	21905	80	22049	84	22124	293	22220	77	22351	86
21743	84	21906	80	22050	84	22125	293	22222	77	22355	86
21744	84	21907	80	22051	84	22126	293	22224	77	22357	86
21750	84	21908	80	22052	84	22129	293	22225	77	22365	86
21751	84	21909	81	22053	84	22130	293	22228	77	22370	86
21752	84	21910	81	22054	84	22132	293	22229	77	22398	86
21753	84	21911	80	22055	84	22133	293	22230	77	22399	86
21754	84	21912	80	22056	84	22134	293	22232	77	22510	56
21760	79	21913	80	22057	84	22135	350	22234	77	22515	56
21761	79	21914	80	22058	81	22136	350	22236	77	22520	56
21762	79	21920	80	22059	81	22137	350	22238	77	22525	56
21763	79	21925	80	22060	83	22138	350	22240	77	22530	56
21764	79	21926	80	22061	83	22140	79	22242	77	22532	56
21780	79	21930	82	22062	83	22141	79	22244	77	22535	56
21781	79	21931	82	22063	83	22142	79	22246	77	22540	56
21782	79	21935	82	22064	83	22143	79	22248	77	22542	56
21783	79	21936	82	22065	83	22145	79	22251	77	22545	56
21784	79	21937	82	22066	83	22146	79	22252	77	22548	56
21786	79	21940	82	22067	85	22147	79	22253	77	22550	56
21787	79	21941	82	22070	83	22148	79	22254	77	22555	56
21788	79	21950	81	22071	83	22150	79	22255	77	22560	56
21789	79	22001	80	22072	83	22151	79	22258	76	22565	56
21790	79	22002	80	22073	83	22155	79	22259	76	22568	56
21792	79	22003	80	22074	83	22156	79	22260	76	22570	56
21793	79	22004	80	22075	85	22158	187	22263	76	22575	56
21794	79	22005	80	22076	85	22159	187	22264	76	22580	56
21795	79	22006	80	22077	85	22160	83	22266	76	22585	56
21796	79	22007	80	22078	187	22161	83	22269	76	22590	56
21798	79	22008	80	22079	187	22162	83	22270	76	22595	56
21800	78	22009	80	22080	187	22163	83	22273	76	22600	56
21801	78	22010	80	22081	187	22164	83	22274	76	22602	56
21802	78	22011	80	22082	187	22167	83	22275	76	22605	56

číslo položky	str.	číslo položky	str.	číslo položky	str.	číslo položky	str.	číslo položky	str.	číslo položky	str.
22610	56	23658	209	23973	183	24111	190	24197	93	24676	72
22615	56	23660	210	23974	183	24114	191	24301	90	24677	72
22620	56	23661	209	23975	183	24115	191	24302	90	24678	72
22625	56	23664	209	23976	183	24118	93	24303	90	24680	276
22630	56	23670	203	23977	183	24119	93	24304	90	24690	202
22701	82	23671	203	23978	183	24120	93	24305	90	24691	202
22702	82	23672	203	23979	183	24121	190	24306	90	24695	202
22703	82	23673	203	23985	183	24122	190	24308	90	24700	72
22704	82	23674	203	23986	183	24124	190	24310	90	24701	72
22705	82	23675	203	23987	183	24125	190	24312	91	24702	72
22706	82	23676	203	23988	183	24126	190	24313	91	24703	72
22707	82	23677	203	23989	183	24128	193	24314	91	24704	72
23270	239	23678	203	24000	183	24130	192	24315	91	24705	72
23400	212	23679	203	24001	183	24131	192	24316	91	24706	65
23401	212	23680	203	24005	183	24132	134	24320	87	24710	73
23402	212	23681	203	24007	182	24133	192	24321	87	24712	65
23406	212	23682	203	24008	183	24134	191	24322	87	24713	65
23407	212	23683	203	24010	182	24135	192	24325	91	24714	65
23410	212	23684	203	24015	182	24136	192	24410	60	24715	65
23411	212	23685	203	24017	182	24137	192	24411	60	24716	65
23412	212	23730	168	24020	182	24140	192	24412	60	24717	69
23415	212	23731	168	24030	182	24141	192	24415	65	24718	69
23416	212	23732	168	24035	183	24142	192	24419	60	24719	69
23417	212	23734	168	24036	183	24143	191	24420	60	24720	65
23420	205	23735	168	24038	183	24144	191	24422	60	24721	65
23506	204	23736	168	24039	183	24145	191	24425	60	24722	65
23507	204	23760	185	24040	183	24147	191	24429	60	24723	69
23508	204	23761	185	24041	183	24148	192	24432	60	24725	70
23515	204	23762	185	24042	183	24149	191	24435	60	24726	70
23520	204	23763	185	24043	183	24150	192	24437	60	24727	290
23525	204	23764	185	24045	89	24151	192	24444	60	24728	290
23530	204	23800	184	24050	91	24152	193	24451	60	24729	290
23531	204	23840	322	24055	88	24152	315	24457	60	24730	69
23551	204	23845	323	24055	277	24153	190	24464	60	24731	69
23560	204	23846	323	24060	88	24155	194	24468	60	24732	69
23561	204	23847	323	24061	88	24156	194	24476	60	24734	73
23562	204	23875	223	24062	88	24158	194	24483	60	24735	70
23563	204	23875	357	24063	88	24159	194	24620	71	24736	70
23564	204	23904	185	24064	88	24159	293	24621	71	24737	70
23565	204	23906	185	24065	88	24160	93	24622	71	24738	70
23566	204	23908	185	24066	88	24161	93	24623	71	24739	70
23570	203	23910	185	24067	88	24162	93	24624	71	24740	70
23571	203	23912	185	24068	88	24163	93	24627	71	24741	70
23572	203	23914	185	24069	88	24164	93	24630	71	24743	70
23573	203	23920	184	24070	88	24165	93	24633	71	24745	70
23574	203	23922	184	24071	88	24166	93	24636	71	24746	70
23585	203	23923	184	24072	88	24167	93	24638	71	24747	70
23587	203	23924	184	24073	88	24168	93	24640	71	24748	70
23589	203	23925	184	24074	88	24169	93	24642	71	24749	70
23591	203	23927	184	24075	88	24170	190	24643	71	24750	61
23595	204	23928	184	24076	88	24171	192	24647	79	24751	61
23598	204	23945	184	24077	88	24173	192	24648	79	24752	290
23600	205	23950	183	24078	88	24174	194	24649	79	24753	290
23601	205	23951	183	24080	89	24175	194	24650	72	24755	66
23602	205	23952	183	24081	89	24176	194	24651	71	24756	66
23605	205	23953	183	24082	89	24177	194	24652	71	24757	69
23607	205	23954	183	24083	89	24178	194	24655	73	24758	69
23620	205	23955	183	24084	89	24180	93	24658	73	24759	69
23625	203	23960	185	24085	89	24181	194	24661	72	24760	72
23626	203	23961	185	24086	89	24185	93	24663	72	24761	72
23628	203	23962	185	24087	89	24186	93	24665	82	24762	72
23630	203	23963	185	24098	89	24187	93	24666	82	24763	72
23632	203	23964	185	24099	89	24188	93	24667	82	24764	72
23635	203	23965	185	24100	190	24189	93	24670	72	24765	72
23637	204	23966	185	24102	190	24190	194	24671	72	24766	72
23650	210	23967	185	24104	190	24190	293	24672	72	24767	72
23652	208	23970	183	24108	93	24192	93	24673	72	24768	72
23655	210	23971	183	24109	93	24195	93	24674	72	24769	72
23657	208	23972	183	24110	190	24196	93	24675	72	24770	70

číslo položky	str.	číslo položky	str.	číslo položky	str.	číslo položky	str.	číslo položky	str.	číslo položky	str.
24771	70	25206	305	28032	11	31082	245	31502	252	32166	248
24772	70	25212	305	28035	13	31091	244	31503	252	32167	248
24773	70	25215	305	28040	12	31101	244	31505	247	32168	248
24774	70	25220	305	28045	12	31111	244	31506	247	32169	248
24775	71	25224	305	28050	14	31121	244	31507	247	32170	247
24776	72	25230	305	28055	14	31131	244	31510	247	32171	248
24777	71	25240	305	28060	17	31132	244	31511	247	32172	248
24778	71	25248	305	28061	17	31140	244	31512	247	32173	247
24779	72	25260	305	28065	17	31141	244	31513	247	32174	248
24780	73	25296	305	28070	10	31142	244	31514	247	32176	248
24781	73	25350	305	28075	15	31143	244	31515	247	32186	248
24782	73	25369	305	28076	18	31144	244	31517	247	32196	248
24783	73	25370	305	28080	19	31145	244	31519	252	32206	248
24784	73	25371	305	28081	19	31146	244	31520	249	32216	248
24785	73	25372	305	28083	19	31148	244	31521	249	32226	248
24786	73	25373	305	28085	19	31150	245	31522	249	32234	248
24787	73	25374	305	28086	19	31151	245	31523	249	32240	248
24788	73	25376	305	28090	20	31155	245	31524	249	32265	250
24789	73	25378	305	28101	21	31218	247	31541	249	32268	251
24790	72	25379	305	28102	20	31220	246	31551	249	32269	251
24791	72	25380	305	28103	20	31221	246	31552	249	32270	250
24792	72	25400	305	28104	21	31222	246	31553	249	32273	250
24793	72	25410	305	28210	28	31231	246	31555	249	32283	250
24794	72	26028	111	28213	28	31232	246	31556	249	32285	250
24795	71	26201	113	28215	27	31233	246	31557	249	32293	250
24796	72	26203	112	28218	28	31234	246	31558	249	32295	251
24797	71	26204	113	28220	25	31235	246	31559	249	32296	251
24798	73	26205	112	28221	23	31270	246	31601	253	32297	251
24799	71	26209	114	28223	28	31271	246	31602	253	32298	251
25001	305	26211	113	28225	24	31280	246	31603	253	32301	251
25002	305	26216	114	28228	28	31281	246	31610	249	32302	251
25003	305	26217	114	28229	28	31320	247	31641	253	32311	255
25004	305	26218	114	28230	26	31322	247	31651	253	32312	254
25005	305	26219	114	28233	28	31330	246	31655	253	32313	251
25006	305	26520	115	28240	36	31332	246	32001	250	32314	254
25009	305	26521	115	28267	29	31334	246	32002	250	32315	255
25012	305	26705	228	28275	50	31340	246	32003	250	32316	255
25015	305	26706	228	28278	50	31341	246	32013	250	32317	254
25016	305	26707	228	28280	50	31343	246	32014	250	32318	255
25020	305	26720	228	28282	50	31360	246	32015	250	32319	255
25024	305	26721	228	28340	37	31362	246	32016	250	32320	254
25025	305	26722	228	28342	37	31380	246	32018	250	32321	255
25030	305	26730	272	28345	37	31382	246	32020	250	32322	255
25040	305	26731	272	28346	37	31390	246	32021	250	32323	255
25048	305	26735	272	30003	256	31392	246	32022	253	32324	255
25060	305	26736	272	30003	259	31400	246	32023	253	32325	255
25096	305	26740	273	30004	256	31402	246	32024	250	32326	255
25150	305	26775	292	30004	259	31403	246	32026	250	32327	254
25153	305	26780	273	30005	256	31404	246	32037	251	32328	255
25155	305	26781	273	30005	259	31452	253	32038	251	32329	254
25160	305	26782	273	30007	256	31453	253	32040	253	32330	255
25162	305	26783	273	30007	259	31454	253	32041	253	32331	255
25163	305	26973	216	31005	245	31455	247	32042	253	32332	254
25164	305	26974	216	31006	245	31456	247	32043	253	32333	254
25167	305	26975	216	31007	245	31461	248	32044	253	32335	255
25169	305	26976	216	31008	245	31467	248	32050	253	32337	254
25170	305	26977	216	31009	245	31468	248	32051	253	32338	254
25171	305	28000	4	31011	245	31471	248	32052	253	33168	254
25179	305	28001	5	31021	245	31481	248	32053	253	33275	296
25180	305	28002	5	31031	245	31491	248	32060	250	34005	256
25181	305	28003	6	31041	245	31493	248	32062	250	34006	256
25182	305	28004	6	31051	245	31494	248	32064	250	34007	256
25183	305	28005	7	31052	245	31495	248	32066	250	34027	255
25184	305	28006	7	31053	245	31496	248	32089	251	34028	255
25186	305	28007	8	31061	245	31497	252	32161	248	34033	260
25188	305	28008	8	31062	245	31498	248	32162	248	34041	256
25189	305	28021	9	31071	245	31499	248	32163	248	34051	256
25190	305	28025	9	31072	245	31500	248	32164	248	34053	256
25195	305	28030	11	31081	245	31501	252	32165	248	34061	256

číslo položky	str.	číslo položky	str.	číslo položky	str.	číslo položky	str.	číslo položky	str.	číslo položky	str.
34071	256	34405	258	35082	263	35345	40	36130	277	37115	291
34081	256	34406	259	35085	262	35345	286	36136	277	37117	278
34091	256	34407	259	35086	262	35346	41	36138	277	37119	291
34101	256	34409	259	35087	262	35346	288	36139	277	37120	291
34111	256	34410	259	35091	262	35347	41	36140	277	37121	296
34115	256	34411	259	35092	262	35347	288	36145	274	37122	296
34116	256	34412	259	35093	262	35348	40	36160	274	37123	364
34117	256	34413	259	35094	263	35348	286	36175	274	37124	364
34121	256	34414	259	35095	263	35360	46	36190	274	37125	282
34122	256	34415	258	35096	263	35361	46	36191	274	37126	282
34132	256	34416	258	35103	264	35362	46	36195	277	37127	282
34142	256	34417	259	35113	264	35500	266	36199	274	37129	364
34152	256	34418	259	35123	264	35501	266	36200	274	37130	281
34153	256	34419	258	35125	264	35502	266	36300	209	37131	281
34154	256	34420	258	35126	264	35503	266	36308	292	37132	281
34155	256	34421	259	35127	264	35504	266	36310	273	37135	231
34156	256	34422	259	35142	262	35505	266	36312	292	37139	231
34157	256	34423	259	35300	38	35506	266	36318	283	37140	231
34158	256	34424	259	35300	261	35507	266	36319	283	37141	231
34159	256	34425	259	35305	39	35508	266	36325	283	37142	231
34160	256	34426	259	35305	262	35510	266	36326	16	37143	231
34200	252	34428	259	35310	38	35511	266	36326	283	37144	231
34201	252	34429	259	35310	261	35512	266	36328	16	37145	231
34202	252	34439	258	35311	38	35514	266	36329	16	37148	282
34203	252	34440	258	35311	261	35515	266	36410	208	37149	282
34221	260	34441	258	35315	39	35516	266	37005	302	37150	282
34223	260	34442	258	35315	262	35517	266	37006	279	37151	282
34231	260	34443	258	35316	38	35518	267	37006	279	37152	282
34235	260	34445	258	35316	261	35519	267	37007	279	37153	282
34237	260	34446	258	35317	38	35524	267	37007	279	37154	282
34238	260	34447	258	35317	261	35525	267	37008	279	37155	280
34241	260	34448	259	35318	38	35527	267	37009	279	37156	280
34243	260	34449	258	35318	261	35532	267	37011	278	37157	280
34251	260	34450	258	35319	38	35533	267	37012	279	37158	282
34261	260	34451	258	35319	261	35539	267	37021	278	37162	281
34262	260	34452	259	35320	50	35540	267	37025	278	37166	273
34265	260	34453	258	35322	50	35542	267	37025	278	37170	281
34271	252	34454	258	35323	42	35552	267	37026	278	37171	281
34272	252	34455	259	35323	289	35553	267	37026	278	37172	281
34273	252	34456	259	35325	42	35555	267	37028	278	37173	282
34274	252	34457	259	35325	289	35603	269	37028	278	37174	282
34275	252	34458	259	35326	42	35604	269	37029	278	37175	281
34276	252	34480	258	35326	289	35605	269	37029	278	37176	281
34280	252	34481	258	35327	42	35833	52	37031	253	37177	282
34281	252	34482	258	35327	289	35845	52	37041	253	37178	282
34282	252	34485	258	35328	42	35850	52	37050	278	37185	281
34283	252	34486	258	35328	42	36014	276	37051	253	37186	281
34284	252	34490	259	35328	289	36024	276	37052	278	37187	281
34285	252	34491	259	35328	289	36034	276	37053	278	37188	281
34300	292	34496	259	35329	42	36035	276	37054	278	37189	281
34301	252	34500	260	35329	42	36036	276	37055	278	37190	281
34303	292	35006	263	35329	289	36046	276	37065	284	37192	281
34304	252	35007	263	35329	289	36056	277	37066	284	37195	282
34305	252	35011	264	35330	40	36057	277	37067	284	37196	282
34305	292	35012	263	35330	287	36058	277	37068	284	37197	282
34306	252	35013	263	35331	41	36059	277	37069	284	37198	282
34306	292	35015	264	35331	288	36076	275	37070	284	37199	282
34307	252	35021	264	35332	41	36077	275	37094	284	37200	280
34307	292	35023	262	35332	288	36080	275	37095	284	37201	280
34308	252	35038	262	35333	41	36081	275	37096	284	37202	280
34308	292	35048	264	35333	288	36082	275	37097	284	37203	280
34315	293	35058	262	35334	41	36085	275	37098	284	37204	280
34316	131	35059	263	35334	288	36086	275	37101	253	37205	280
34316	293	35068	264	35335	42	36087	275	37102	280	37210	280
34400	258	35069	263	35335	289	36102	275	37105	280	37211	280
34401	258	35070	263	35336	41	36103	275	37106	280	37212	280
34402	259	35078	263	35336	288	36105	275	37107	280	37216	291
34403	259	35079	263	35344	41	36126	277	37111	253	37217	291
34404	258	35081	263	35344	287	36128	277	37114	291	37218	291

číslo položky	str.	číslo položky	str.	číslo položky	str.	číslo položky	str.	číslo položky	str.	číslo položky	str.
37220	280	37344	236	38022	299	38949	224	39217	290	42179	353
37230	292	37345	236	38024	297	38950	290	39218	290	42180	354
37231	292	37350	235	38025	298	38951	290	39219	290	42181	354
37232	292	37500	267	38026	279	38952	290	39238	292	42182	354
37233	292	37501	267	38027	297	38953	290	39240	290	42185	354
37234	292	37505	267	38028	297	38954	290	39241	290	42186	354
37235	292	37506	267	38030	299	38955	224	39242	290	42187	354
37236	291	37509	268	38031	299	38956	224	39243	290	42188	354
37237	291	37510	268	38032	297	38957	224	39244	290	42190	224
37238	291	37511	268	38042	279	38958	224	39245	292	42190	354
37239	291	37512	268	38045	279	38959	224	40050	353	42201	355
37243	303	37515	268	38050	223	38960	224	40051	353	42202	355
37244	303	37516	268	38052	223	38961	224	40052	353	42203	355
37245	303	37517	268	38054	223	38963	226	40053	353	42207	355
37246	303	37518	268	38055	223	38964	225	40054	353	42208	355
37247	303	37527	268	38060	223	38965	225	40055	353	42209	355
37248	303	37530	268	38063	223	38966	225	40056	353	42210	355
37250	303	37532	268	38065	223	38968	224	40057	353	42211	355
37251	303	37533	268	38095	223	38969	226	40058	353	42212	355
37252	303	37539	269	38096	223	38970	290	40059	353	42213	355
37253	303	37541	269	38097	223	38971	290	40060	353	42214	355
37255	225	37545	307	38895	284	38972	226	40075	353	42217	355
37256	225	37546	307	38896	284	38973	226	40076	353	42218	355
37257	225	37549	210	38899	284	38975	226	40077	353	42219	355
37258	225	37553	212	38900	284	38980	224	40100	352	42220	355
37259	225	37560	209	38901	285	38981	224	40120	352	42221	355
37263	225	37564	269	38902	285	38985	226	41050	352	42228	355
37264	225	37570	192	38903	285	38990	225	41080	352	42229	355
37266	225	37570	209	38904	285	38991	225	41081	352	42230	355
37267	225	37611	53	38905	285	38995	225	41082	352	42244	355
37268	225	37615	53	38906	285	39000	296	41083	352	42248	355
37270	225	37616	53	38907	284	39001	296	41100	352	42249	355
37271	225	37647	218	38908	284	39002	296	41101	352	42251	355
37272	225	37660	306	38909	284	39003	296	41102	352	42252	355
37273	225	37730	53	38910	285	39005	296	41103	352	42253	355
37275	225	37731	53	38911	285	39010	296	41120	352	42255	355
37280	226	37732	53	38912	285	39012	296	41121	352	42256	355
37281	226	37733	53	38913	285	39014	296	41122	352	42257	355
37285	282	37740	53	38914	285	39020	296	41123	352	42260	355
37286	282	37741	53	38915	285	39021	296	41150	352	42261	355
37287	282	37744	53	38916	285	39045	296	41151	352	42312	291
37288	282	37745	53	38917	285	39065	296	41152	352	42312	354
37289	282	37746	53	38918	285	39090	296	41153	352	42365	222
37290	303	37747	53	38919	279	39145	296	42101	352	42366	222
37291	303	37750	53	38920	279	39165	296	42102	352	42367	222
37295	226	37751	53	38923	279	39190	296	42103	352	42368	222
37296	226	37760	53	38924	225	39192	296	42115	291	42420	291
37297	226	37761	53	38925	224	39192	323	42120	291	43050	358
37300	235	38000	298	38926	226	39193	296	42150	353	43058	358
37301	235	38001	297	38927	224	39193	323	42151	353	43060	358
37302	235	38002	298	38928	225	39194	223	42152	353	43068	358
37303	235	38003	298	38929	225	39195	223	42153	353	43071	358
37308	236	38004	299	38930	226	39196	223	42155	353	43072	358
37309	236	38005	299	38931	224	39197	223	42156	353	43077	358
37310	235	38006	298	38932	224	39198	223	42157	353	43082	358
37311	235	38007	298	38933	226	39199	223	42158	353	43083	358
37317	313	38008	298	38934	225	39200	223	42160	353	43084	358
37320	235	38009	298	38935	226	39201	223	42161	353	43086	358
37321	235	38010	298	38937	226	39202	223	42162	353	43087	359
37325	234	38012	297	38939	226	39203	223	42163	353	43089	359
37326	234	38013	297	38940	226	39204	223	42170	354	43090	359
37328	234	38014	299	38941	226	39205	223	42171	354	43094	359
37330	234	38014	299	38942	225	39206	290	42172	354	43097	358
37331	234	38015	299	38943	226	39207	290	42173	354	43098	359
37332	234	38016	299	38944	224	39208	290	42174	354	43099	359
37340	236	38017	299	38945	224	39210	290	42175	353	43300	347
37341	236	38018	299	38946	224	39212	290	42176	353	43301	347
37342	236	38020	298	38947	224	39214	290	42177	353	44041	322
37343	236	38021	299	38948	224	39216	290	42178	353	44042	322

číslo položky	str.	číslo položky	str.	číslo položky	str.	číslo položky	str.	číslo položky	str.	číslo položky	str.
44043	322	45034	319	45099	310	45178	333	45268	335	45391	324
44050	322	45035	318	45100	334	45179	331	45269	335	45392	324
44053	319	45036	322	45101	334	45180	327	45270	39	45393	324
44950	131	45038	319	45102	334	45181	327	45271	39	45394	324
44950	315	45039	319	45104	334	45182	333	45280	334	45395	324
44955	319	45040	319	45105	334	45183	333	45283	334	45396	325
44960	323	45041	319	45106	334	45184	331	45285	334	45397	325
44965	338	45042	319	45107	334	45185	331	45286	334	45398	325
44970	313	45043	323	45108	334	45186	331	45287	334	45399	325
44971	313	45044	322	45110	326	45187	332	45289	329	45400	325
44972	310	45045	136	45111	327	45190	332	45290	329	45401	325
44980	310	45045	320	45112	327	45191	332	45291	329	45450	357
44980	310	45046	136	45113	327	45192	332	45292	329	45451	357
44980	311	45046	320	45114	327	45193	332	45293	329	45452	357
44981	310	45047	323	45115	327	45194	332	45294	328	45453	357
44981	310	45048	136	45116	326	45195	332	45295	328	45460	357
44981	311	45048	312	45117	326	45196	332	45296	328	45461	357
44981	311	45048	320	45118	326	45197	332	45297	328	45462	357
44982	310	45049	322	45120	327	45198	332	45298	328	45463	357
44982	310	45050	338	45122	327	45199	332	45299	328	45465	357
44982	311	45051	338	45123	326	45200	332	45300	333	45466	357
44983	310	45052	338	45124	326	45203	332	45301	333	45467	357
44983	310	45053	339	45125	326	45204	332	45320	339	45470	357
44983	311	45054	339	45126	326	45206	332	45321	339	45471	226
44984	311	45055	339	45130	329	45211	332	45323	337	45471	323
44984	312	45056	318	45131	329	45213	328	45323	348	45472	323
44984	312	45057	318	45132	329	45214	327	45325	337	45473	323
44985	311	45058	318	45133	329	45215	329	45326	337	45480	357
44985	312	45059	318	45134	330	45216	328	45326	337	45485	357
44991	311	45060	193	45135	329	45217	329	45327	337	45490	314
44992	311	45060	315	45136	329	45218	328	45328	337	45496	357
44995	314	45061	193	45137	329	45219	329	45329	337	45497	357
44996	312	45061	315	45138	328	45220	334	45330	337	45498	357
44997	312	45062	193	45139	328	45221	334	45330	350	45499	357
44998	312	45062	315	45140	328	45222	334	45331	337	45500	321
44999	313	45063	310	45141	328	45223	334	45331	350	45502	321
45000	314	45065	318	45142	328	45224	334	45341	333	45503	321
45001	314	45066	318	45143	328	45225	334	45342	333	45505	321
45002	314	45067	318	45144	329	45226	334	45343	333	45506	321
45003	314	45068	136	45145	329	45227	334	45344	333	45508	321
45005	314	45068	312	45146	330	45228	334	45345	333	45509	321
45006	314	45068	320	45147	331	45229	334	45346	333	45511	321
45007	314	45069	131	45150	331	45239	336	45347	333	45512	321
45008	314	45069	315	45151	331	45240	336	45348	333	45513	321
45009	314	45070	340	45152	330	45241	336	45349	333	45515	321
45010	312	45071	338	45153	330	45242	336	45350	333	45516	321
45011	313	45073	136	45154	330	45244	335	45351	333	45517	321
45012	313	45073	320	45155	330	45245	335	45352	333	45518	321
45014	312	45074	323	45156	331	45246	335	45353	333	45519	321
45015	313	45079	319	45158	330	45247	335	45354	333	45520	321
45016	313	45080	319	45159	331	45248	335	45370	136	45521	321
45017	311	45081	131	45160	331	45249	335	45370	320	45522	321
45018	312	45081	315	45161	331	45250	335	45372	325	45523	321
45019	312	45082	131	45162	330	45251	335	45372	333	45524	321
45020	310	45082	315	45163	330	45253	335	45373	325	45525	321
45021	312	45083	131	45164	331	45254	335	45373	333	45526	321
45023	310	45083	315	45167	330	45256	335	45374	325	45527	321
45025	313	45084	131	45168	331	45257	335	45374	333	45528	321
45026	312	45084	315	45169	331	45260	335	45375	325	45529	321
45027	313	45085	319	45170	336	45261	335	45375	333	45530	321
45029	313	45086	323	45171	336	45262	335	45376	325	45531	321
45030	193	45088	311	45172	336	45262	335	45376	333	45532	321
45030	315	45089	311	45172	336	45263	335	45377	325	45533	321
45031	193	45093	323	45173	336	45263	335	45377	333	45534	321
45031	315	45094	311	45173	336	45265	335	45385	324	45535	322
45032	193	45095	310	45174	333	45266	335	45386	324	45540	321
45032	315	45096	310	45175	332	45267	335	45388	324	45541	321
45033	193	45097	311	45176	333	45267	335	45389	324	45542	321
45033	315	45098	310	45177	333	45268	335	45390	324	45543	321

číslo položky	str.	číslo položky	str.	číslo položky	str.	číslo položky	str.	číslo položky	str.	číslo položky	str.
45550	321	45660	322	48094	49	50544	233	51244	227	52055	307
45551	321	45661	322	48095	49	50549	232	51245	227	52060	307
45552	321	45662	322	48096	49	50550	230	51246	227	52065	307
45553	321	45663	322	48097	49	50551	230	51247	227	52070	300
45555	322	45664	322	48410	306	50553	230	51258	227	52071	300
45556	321	45670	322	48411	306	50554	230	51259	227	52075	300
45557	321	45671	322	48415	306	50555	233	51260	227	52076	300
45558	321	45672	322	48420	306	50556	230	51261	227	52077	300
45559	321	45673	322	48452	307	50557	232	51262	227	52078	300
45560	322	48001	48	48453	307	50558	232	51264	227	52101	349
45562	321	48002	48	48454	307	50559	230	51271	227	52102	349
45563	321	48004	47	48455	307	50560	230	51272	227	52103	349
45564	321	48005	47	48456	307	50562	230	51273	227	52104	349
45565	321	48006	47	48457	307	50563	230	51274	227	52105	349
45570	354	48007	47	48719	273	50564	230	51275	227	52108	348
45571	354	48008	49	48729	269	50570	230	51276	227	52109	349
45572	354	48009	49	48730	269	50571	230	51278	227	52113	349
45573	354	48010	48	48731	269	50585	233	51280	227	52114	349
45580	354	48011	48	50030	355	50585	303	51281	227	52115	349
45600	334	48013	15	50031	355	50586	233	51282	227	52116	349
45601	334	48013	48	50032	355	50586	303	51283	227	52119	348
45602	334	48015	47	50033	355	50587	233	51284	227	52126	350
45603	334	48020	46	50035	228	50587	303	51286	227	52130	280
45604	334	48021	46	50035	355	50588	233	51287	227	52135	348
45605	334	48022	46	50036	228	50588	303	51288	227	52160	349
45606	334	48030	47	50036	355	51100	228	51300	227	52161	349
45607	334	48031	48	50037	355	51102	228	51301	227	52162	349
45608	334	48032	48	50038	355	51103	228	51302	227	52163	349
45609	334	48033	48	50040	355	51104	228	51303	227	52164	349
45610	334	48034	48	50041	355	51105	228	51304	227	52168	348
45611	334	48036	47	50042	355	51106	228	51305	227	52173	348
45612	334	48037	47	50050	222	51107	228	51306	227	52175	348
45613	334	48040	48	50050	222	51108	228	51307	227	52176	348
45614	334	48041	48	50051	222	51109	228	51308	227	52185	349
45615	334	48042	48	50052	222	51110	228	51320	227	52186	349
45616	334	48043	48	50052	222	51111	228	51321	227	52187	349
45617	334	48046	46	50100	227	51120	228	51322	227	52188	349
45618	334	48046	49	50101	227	51121	228	51323	227	52189	349
45619	334	48047	46	50102	227	51122	228	51324	227	52190	349
45620	334	48047	49	50103	227	51123	228	51325	227	52191	349
45621	334	48050	49	50104	227	51124	228	51327	227	52192	349
45622	334	48051	49	50106	227	51125	228	51341	227	52193	349
45623	334	48054	49	50108	227	51126	228	51402	228	52194	349
45624	334	48055	49	50500	233	51127	228	51403	228	52195	349
45625	334	48056	49	50503	233	51130	228	51404	228	52196	349
45626	334	48057	49	50510	230	51131	228	51405	228	52197	348
45627	334	48060	49	50511	230	51132	228	51406	228	52198	348
45628	334	48061	49	50512	230	51196	228	51407	228	52202	300
45629	334	48062	49	50513	230	51197	228	51408	228	52203	300
45630	334	48063	49	50514	230	51198	228	51410	228	52204	300
45631	334	48064	49	50518	232	51199	228	51412	228	52205	300
45632	334	48065	49	50519	232	51204	227	51413	228	52206	300
45633	334	48066	49	50520	232	51205	227	51414	228	52207	300
45634	334	48067	49	50522	232	51206	227	51415	228	52208	300
45635	334	48068	49	50524	232	51207	227	51416	228	52212	300
45636	334	48070	49	50525	232	51208	227	51417	228	52213	300
45637	334	48071	49	50526	232	51209	227	51418	228	52214	300
45638	334	48072	49	50527	233	51210	227	51420	228	52215	300
45639	334	48075	49	50529	232	51211	227	51430	228	52216	300
45650	322	48076	49	50531	233	51212	227	51431	228	52217	300
45651	322	48077	49	50532	233	51220	227	51432	228	52218	300
45652	322	48080	49	50533	232	51221	227	51433	228	52220	300
45653	322	48081	49	50535	232	51222	227	51435	228	52283	300
45654	322	48085	49	50536	232	51225	227	51436	228	52284	300
45655	322	48086	49	50537	232	51226	227	51450	228	52285	300
45656	322	48087	49	50539	232	51227	227	52011	249	52286	300
45657	322	48090	49	50540	233	51241	227	52011	303	52288	300
45658	322	48091	49	50541	233	51242	227	52030	252	52305	301
45659	322	48093	49	50542	233	51243	227	52050	307	52306	301

# REJSTRÍK POLOŽEK



číslo položky	str.	číslo položky	str.	číslo položky	str.	číslo položky	str.	číslo položky	str.	číslo položky	str.
52328	301	55356	229	61003	344	61098	345	61236	217	70025	44
52331	301	55357	229	61004	344	61098	351	61240	197	70026	44
52334	301	55358	229	61005	341	61111	346	61250	351	70030	44
52391	301	55359	229	61005	351	61112	346	61251	319	70031	44
52421	301	55360	229	61006	341	61114	346	61251	351	70032	44
52424	301	55361	229	61006	351	61120	346	61252	351	70033	44
52428	301	55362	229	61007	341	61121	346	61253	351	70035	44
52456	301	55400	356	61008	341	61130	338	61254	351	70036	44
52471	301	55401	356	61009	345	61131	338	61255	351	70037	44
52600	302	55402	356	61010	341	61132	339	61256	351	70040	43
52601	302	55403	356	61012	345	61133	339	61290	346	70060	44
52602	302	55404	356	61013	344	61134	339	61291	346	70061	44
52605	302	55405	356	61014	345	61135	339	61292	346	70062	44
52610	302	55406	356	61015	341	61141	339	61293	346	70063	44
52611	248	55420	356	61018	345	61142	340	61294	318	70064	43
52612	248	55421	356	61019	344	61143	340	61295	318	70065	44
52620	302	55422	356	61020	342	61144	340	61296	318	70066	43
52625	302	55423	356	61021	342	61145	340	61297	318	70070	44
52630	302	55424	356	61022	343	61146	340	61299	356	70075	44
52635	302	55425	356	61024	343	61150	338	61300	356	70090	45
52640	302	55429	356	61025	342	61155	341	61301	356	70091	45
52645	302	55430	356	61026	342	61156	341	61302	356	70092	45
52652	302	55431	356	61027	343	61157	341	61320	197	70093	45
52656	302	55432	356	61028	345	61158	341	61321	197	70094	45
52662	302	55433	356	61029	341	61161	344	61322	197	70095	45
52666	302	55436	356	61030	340	61162	344	61323	197	70096	45
52671	302	55437	356	61031	340	61163	344	61324	197	70098	210
52694	302	55450	356	61032	340	61164	345	61325	197	81011	361
52695	302	55452	356	61033	340	61165	345	61326	197	81012	361
54008	303	55453	356	61034	340	61166	345	61327	197	81013	361
55040	229	55454	356	61035	346	61169	251	61328	197	81014	361
55050	229	55455	356	61036	346	61171	350	61329	197	81015	361
55051	229	55456	356	61038	346	61172	348	61330	197	81016	361
55060	229	55457	356	61040	346	61172	350	61331	197	81022	361
55080	229	55460	356	61042	346	61173	350	61340	317	81023	361
55100	229	55461	356	61044	345	61174	350	61341	317	81024	361
55120	229	55462	356	61045	340	61175	350	61342	317	81025	361
55140	229	55465	356	61046	340	61176	350	61343	317	81035	361
55160	229	55640	229	61047	340	61177	350	61344	317	81036	361
55180	229	55642	229	61048	340	61183	351	61345	317	81053	364
55181	229	55645	229	61050	342	61184	351	61346	317	81054	364
55200	229	55650	229	61050	351	61189	351	65062	307	81057	364
55201	229	60001	347	61051	342	61190	351	65063	307	81070	364
55220	229	60006	347	61051	351	61192	350	65064	307	81071	364
55221	229	60008	347	61052	343	61193	350	65065	307	81077	364
55240	229	60012	347	61052	351	61194	350	69900	294	81100	364
55300	229	60018	347	61053	343	61195	351	69901	294	81101	364
55315	229	60019	347	61054	343	61200	350	69902	294	81102	364
55316	229	60020	347	61056	342	61201	347	69903	294	81103	364
55317	229	60022	347	61057	342	61201	350	69904	295	81104	364
55318	229	60100	251	61058	343	61202	350	69905	294	81105	364
55319	229	60115	273	61059	343	61203	345	69906	294	81106	364
55331	229	60116	273	61060	340	61204	351	69907	295	81150	362
55332	229	60117	273	61061	340	61205	351	69908	295	81151	362
55333	229	60118	273	61062	340	61207	351	69909	295	81152	362
55334	229	60121	273	61063	340	61208	350	69910	295	81155	362
55335	229	60123	273	61067	346	61209	345	69911	295	81160	362
55336	229	60125	272	61068	346	61215	351	69912	295	81165	362
55337	229	60130	272	61069	346	61218	251	69914	294	81170	362
55339	229	60132	272	61070	346	61219	351	69917	295	81175	362
55340	229	60155	272	61077	351	61221	318	69918	294	81178	362
55341	229	60157	272	61079	351	61221	318	69919	294	81180	362
55342	229	60201	347	61079	351	61221	318	69920	295	81185	362
55350	229	60206	347	61085	319	61221	318	69923	295	81186	362
55351	229	60208	347	61088	342	61222	345	69928	295	81188	362
55352	229	60212	347	61089	342	61223	344	69930	296	81189	362
55353	229	61000	342	61090	343	61224	346	69931	296	81190	362
55354	229	61001	342	61097	344	61224	346	70020	44	81191	362
55355	229	61002	343	61097	351	61230	351	70021	44	81195	361

číslo položky	str.	číslo položky	str.	číslo položky	str.	číslo položky	str.	číslo položky	str.	číslo položky	str.
81196	361	81267	363	81337	363	81408	363	82103	307		
81197	361	81268	363	81338	363	81409	363	82104	307		
81200	363	81269	363	81339	363	81410	363	89775	51		
81201	363	81270	363	81340	363	81411	363	89970	51		
81202	363	81271	363	81341	363	81412	363	89973	51		
81203	363	81272	363	81342	363	81413	363	89975	51		
81204	363	81273	363	81343	363	81414	363	89980	51		
81205	363	81274	363	81344	363	81415	363	89985	51		
81206	363	81275	363	81345	363	81416	363	89987	51		
81207	363	81276	363	81346	363	81417	363	89988	51		
81208	363	81277	363	81347	363	81418	363	89989	51		
81209	363	81278	363	81348	363	81419	363	89990	51		
81210	363	81279	363	81349	363	81420	363	90070	278		
81211	363	81280	363	81350	363	81421	363	90071	278		
81212	363	81281	363	81351	363	81422	363	90072	278		
81213	363	81282	363	81352	363	81423	363	90191	56		
81214	363	81284	363	81353	363	81424	363	90192	57		
81215	363	81285	363	81354	363	81425	363	18610A	150		
81216	363	81286	363	81355	363	81426	363	18611A	150		
81217	363	81287	363	81356	363	81427	363	18612A	150		
81218	363	81288	363	81357	363	81428	363	18613A	150		
81219	363	81289	363	81358	363	81429	363	18614A	150		
81220	363	81290	363	81359	363	81430	363	18615A	150		
81221	363	81291	363	81360	363	81431	363	18632A	147		
81222	363	81292	363	81361	363	81432	363	18633A	147		
81223	363	81293	363	81362	363	81433	363	18636A	147		
81224	363	81294	363	81363	363	81434	363	18637A	147		
81225	363	81295	363	81364	363	81435	363	18638A	147		
81226	363	81296	363	81365	363	81436	363	18827A	147		
81227	363	81297	363	81366	363	81437	363	18828A	147		
81228	363	81298	363	81367	363	81438	363	18830A	147		
81229	363	81299	363	81370	363	81439	363	18831A	147		
81230	363	81300	363	81371	363	81440	363	81011A	361		
81231	363	81301	363	81372	363	81441	363	81011F	361		
81232	363	81302	363	81373	363	81442	363	81011G	361		
81233	363	81303	363	81374	363	81443	363	81011H	361		
81234	363	81304	363	81375	363	81444	363	81011R	361		
81235	363	81305	363	81376	363	81445	363	M90203	365		
81236	363	81306	363	81377	363	81447	363	M90204	365		
81237	363	81307	363	81378	363	81448	363	M90205	365		
81238	363	81308	363	81379	363	81449	363	M90206	365		
81239	363	81309	363	81380	363	81450	363	M90207	365		
81240	363	81310	363	81381	363	81451	363	M90210	365		
81241	363	81311	363	81382	363	81452	363	M90220	365		
81242	363	81312	363	81383	363	81453	363	M90221	365		
81243	363	81313	363	81384	363	81454	363	M90222	365		
81244	363	81314	363	81385	363	81455	363	M90400	365		
81245	363	81315	363	81386	363	81456	363	M90403	365		
81246	363	81316	363	81387	363	81457	363	M90519	365		
81247	363	81317	363	81388	363	81458	363				
81248	363	81318	363	81389	363	81459	363				
81249	363	81319	363	81390	363	81460	363				
81250	363	81320	363	81391	363	81461	363				
81251	363	81321	363	81392	363	81462	363				
81252	363	81322	363	81393	363	81463	363				
81253	363	81323	363	81394	363	81466	363				
81254	363	81324	363	81395	363	81467	363				
81255	363	81325	363	81396	363	81468	363				
81256	363	81326	363	81397	363	81469	363				
81257	363	81327	363	81398	363	81470	363				
81258	363	81328	363	81399	363	81471	363				
81259	363	81329	363	81400	363	81472	363				
81260	363	81330	363	81401	363	81473	363				
81261	363	81331	363	81402	363	81486	363				
81262	363	81332	363	81403	363	81600	364				
81263	363	81333	363	81404	363	81603	364				
81264	363	81334	363	81405	363	82100	307				
81265	363	81335	363	81406	363	82101	307				
81266	363	81336	363	81407	363	82102	307				

# GRAFICKÉ SYMBOLY POUŽITÉ V KATALOGU

## PIKTOGRAMY SPECIFIKACE PRODUKTŮ



### SPECIFIKACE POUŽITÍ

- dřevo
- keramika
- plasty
- hliník
- měď
- kámen
- sklo
- zdivo
- papír
- ocel
- kompozit
- obklady
- nerezová ocel
- omítka
- dřevo se šrouby, hřebíky
- sádrokarton
- pro vrtání do materiálů s pevností v tahu do ...

- S2** · funkční části z vysoce legované nástrojové oceli S2
- HSS** · funkční části vyrobeny z rychlořezné oceli
- Cr-Mo** · funkční části z chrom-molybdenové oceli
- CrV** · funkční části z chrom-vanadové oceli
- INOX** · funkční části z nerezavějící oceli
- NYLON** · nylonová rukojeť
- TEFLON** · teflonový povrch
- Zn** · zinkováno
- TiN** · povrch potažen nitridem titanu
- HRC 58-61** · tvrdost materiálu funkčních částí podle Rockwella
- 40% PES** · složení materiálu - obsahuje 40% polyesteru
- PES** · složení materiálu - vyrobeno z polyesteru
- DIAMANT** · diamantová zrna na povrchu funkčních částí
- MAGNETICKÉ** · magnetické

- SDS+** · způsob uchycení
- SDS MAX** · způsob uchycení
- M14** · způsob uchycení
- 72T** · počet zubů ráčny
- 36T** · počet zubů ráčny
- 1/2"** · velikost uchycení
- 3/4"** · velikost uchycení
- 1/4"** · velikost uchycení
- 27 dB** · údaj o výši ochrany sluchu
- DIN 3113** · splňuje uvedenou normu
- IP 54** · splňuje uvedenou normu
- 32x** · počet produktů v sadě
- II. class** · splňuje uvedenou třídu přesnosti
- III. class** · splňuje uvedenou třídu přesnosti
- SNOW** · vhodné do chladného počasí
- ERGO HANDLE** · ergonomická rukojeť
- HOBBY** · pro hobby použití
- 2x AAA** · počet a typ baterií
- UV STABLE** · odolné proti UV záření
- RUBBER ENDS** · nárazuvzdorné gumové koncovky

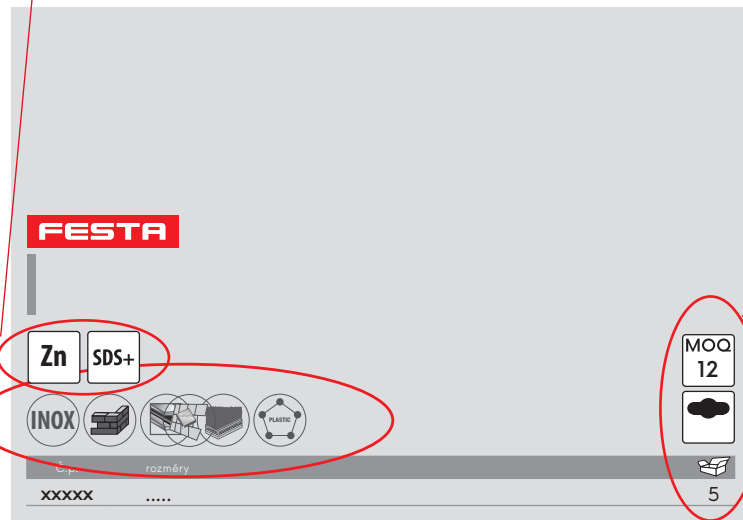

### SPECIFIKACE BALENÍ

- KRABICE** · baleno v krabici
- ZÁVĚSEM** · balení se závěsem
- MOQ 12** · minimální objednatelné množství
- 5** · počet kusů v balení

## SPECIFIKACE PRODUKTŮ VODNÍHO PROGRAMU

volitelný tvar proudu vody



minimální a maximální tlak



maximální průtok vody



zavlažovaná plocha



velikost závitů pro připojení adaptéru



průměr hadice pro připojení do rychlospojky



20

25

26

**FESTA**

PROFESIONÁLNÍ  NÁŘADÍ



festatools



#festatools



festatools



[www.festa.tools](http://www.festa.tools)

HORIZONT.

**FESTA**  
POWER X TOOLS

**FESTA**  
AQUATIC

ROSA KOMELON.

KDS

Stahlberg

SUPER PRO

Lescha

